

# *Hunter*

# UPDATED

## Portable Air Conditioner



English

### Models:

**HPAC-10C150-(A-Z)**

**HPAC-12C150-(A-Z)**

**HPAC-14C150-(A-Z)**

**HPAC-14C150P-(A-Z)**

Form #HPAC

20200224

©2020 Produced exclusively for Mindful, LLC under license by Hunter Fan Company

All rights reserved

# Table of Contents

|   |           |
|---|-----------|
| <b>IDENTIFICATION OF PARTS .....</b>                  | <b>1</b>  |
| <b>AIR CONDITIONER SAFETY .....</b>                   | <b>2</b>  |
| <b>INSTALLATION REQUIREMENTS .....</b>                | <b>2</b>  |
| <b>ELECTRICAL REQUIREMENTS .....</b>                  | <b>3</b>  |
| <b>LOCATION REQUIREMENTS .....</b>                    | <b>3</b>  |
| <b>SAFETY INSTRUCTIONS .....</b>                      | <b>4</b>  |
| <b>INSTALLATION INSTRUCTIONS .....</b>                | <b>4</b>  |
| <b>INSTALLATION IN VERTICAL SLIDING WINDOWS .....</b> | <b>6</b>  |
| <b>INSTALLATION IN HORIZONTAL SLIDING WINDOWS ...</b> | <b>7</b>  |
| <b>PORTABLE AIR CONDITIONER USE .....</b>             | <b>8</b>  |
| <b>STARTING YOUR PORTABLE AIR CONDITIONER .....</b>   | <b>9</b>  |
| <b>USING THE REMOTE .....</b>                         | <b>10</b> |
| <b>USING THE FEATURES .....</b>                       | <b>12</b> |
| <b>DEHUMIDIFICATION &amp; DRAINING .....</b>          | <b>13</b> |
| <b>PORTABLE AIR CONDITIONER USE .....</b>             | <b>14</b> |
| <b>USING THE REMOTE .....</b>                         | <b>15</b> |
| <b>TROUBLESHOOTING .....</b>                          | <b>15</b> |
| <b>WARRANTY .....</b>                                 | <b>17</b> |

# Identification of Parts

## • Front

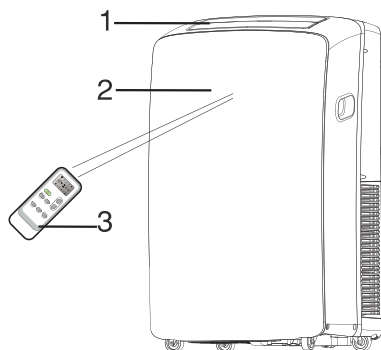

- 1 Cool air outlet
- 2 Signal receptor
- 3 Remote control
- 4 Control panel
- 5 Evaporator air intake
- 6 Transport handle
- 7 Secondary drain port
- 8 Air outlet hose
- 9 Condenser air intake
- 10 Primary drain port

## • Back

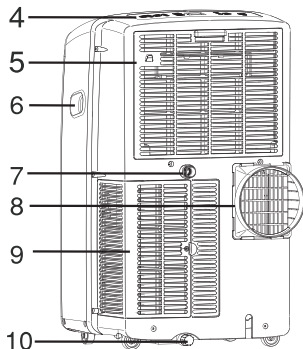

- 11 Drain hose clip (Heat pump models)
- 12 Drain hose (Heat pump models)

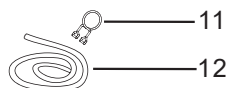

The figures in this manual are based on the external view of a standard model.

They may differ from that of the air conditioner you have selected.

# Air Conditioner Safety

## Your safety and the safety of others is very important.

We have provided many important safety messages in this manual and on your appliance. Always read and obey all safety messages.



This is the safety alert symbol.

This symbol alerts you to potential hazards that can kill or hurt you and others.

All safety messages will follow the safety alert symbol and either the word "DANGER" or "WARNING." These words mean:

 **DANGER**

A hazard that if not avoided will result in death or serious injury.

 **WARNING**

A hazard that if not avoided could result in death or serious injury.

All safety messages will tell you what the potential hazard is and tell you how to reduce the chance of injury.

## IMPORTANT SAFETY INSTRUCTIONS

**WARNING:** To reduce the risk of fire, electrical shock or injury when using your air conditioner, follow these basic precautions:

- Plug into a grounded 3 prong outlet.
- Do not use an extension cord.
- Do not remove ground prong.
- Unplug air conditioner before servicing.
- Do not use an electrical adapter.
- Use two or more people to move and install air conditioner.
- The appliance is not intended for use by young children or impaired persons without supervision. Young children should be supervised to ensure that they do not play with the appliance.

## SAVE THESE INSTRUCTIONS

## STORAGE AND DISPOSING OF THE UNIT

- Please recycle or dispose of the packaging material for product in an environmentally responsible manner.
- Never store or ship the air conditioner upside down or sideways to avoid damage to the compressor.
- Dispose of this appliance in accordance with Federal and Local regulations. Refrigerants must be evacuated before disposal.

# Installation Requirements

- A. Foam seal
- B. Coupling
- C. Flexible exhaust hose
- D. Window exhaust adapter
- E. Screws(4)
- F. Window-lock bracket(2)
- G. Outer slider section
- H. Slider section
- I. Slider section
- J. Slider section
- K. Foam seal-long(2)
- L. Foam seal-short(2)
- M. Drain hose (Heat pump models)
- N. Drain hose clip (Heat pump models)

Gather the required tools and parts before starting installation. Read and follow the instructions provided with any tools listed here.

### Tools needed

- Phillips screwdriver
- Scissors
- Pencil
- Cordless drill and  $\frac{1}{8}$ " bit

### Parts supplied

Check that all parts are included in parts package.

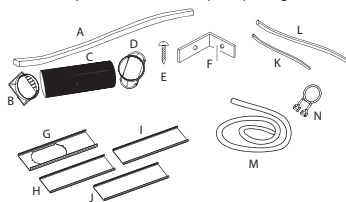

# Electrical Requirements

## ⚠ WARNING



### Electrical Shock Hazard

- Plug into a grounded 3 prong outlet.
- Do not remove ground prong.
- Do not use an adapter.
- Do not use an extension cord.
- Failure to follow these instructions can result in death, fire, or electrical shock.

### Recommended Grounding Method

This portable air conditioner must be grounded. This portable air conditioner is equipped with a power supply cord with a three-prong grounding plug. The cord must be plugged into a mating, grounded three-prong outlet, grounded in accordance with all local codes and ordinances. If a mating outlet is not available, it is the customer's responsibility to have a properly grounded three-prong outlet installed by a qualified electrical installer.

It is the customer's responsibility:

To contact a qualified electrical installer. To assure that the electrical installation is adequate and conforms to the Nation Electrical Code, ANSI/NFPA 70-last edition, and all local codes and ordinances.

Copies of the standards listed may be obtained from:  
 Nation Fire Protection Association  
 1 Batterymarch Park  
 Quincy, Ma 02169-7471  
 www.nfpa.org

### Wiring Requirement

115 V (103.5 min. to 126.5 max.)

15 A time-delay fuse or circuit breaker

### Power Supply Cord

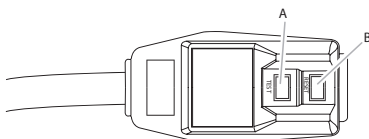

A. Test button  
 B. Reset button

### NOTE:

Your air conditioner's device may differ from the one shown. This room air conditioner is equipped with a power supply cord required by UL. This power supply cord contains state-of-the-art electronics that sense leakage current. If the cord is crushed, the electronics detect leakage current and power will be disconnected in a fraction of a second.

To test your power supply cord:

1. Plug power supply cord into a grounded 3 prong outlet.
2. Press RESET (on some devices, a green light will turn on).
3. Press TEST (listen for click; Reset button will trip, and on some devices, a green light will turn off).
4. Press and release RESET (listen for click; Reset button will latch, and on some devices, a green light will turn on). The power supply cord is ready for operation.

### NOTE:

- The Reset button must be pushed in for proper operation.
- The power supply cord must be replaced if it fails to trip when the test button is pressed or fails to reset.
- Do not use the power supply cord as an off/on switch. The power supply cord is designed as a protective device.
- A damaged power supply cord must be replaced with a new power supply cord obtained from the product manufacturer and must not be repaired.
- The power supply cord contains no user serviceable parts. Opening the tamper-resistant case voids all warranty and performance claims.

# Location Requirements

### NOTE :

- The flexible exhaust hose allows placement of the air conditioner at least 20" from window or door.
- Confirm you are using the correct size air conditioner for the space to be cooled, per sizing recommendations, below:

| Area to be cooled    | DOE Capacity needed(BTUs) |             |
|----------------------|---------------------------|-------------|
| Up to 10'x 20' Room  | 200 sq.ft.                | 5,000/5,500 |
| Up to 15'x 20' Room  | 300 sq.ft.                | 6,000/6,500 |
| Up to 20' x 20'Room  | 400 sq.ft.                | 7,000/7,500 |
| Up to 20' x 25' Room | 500 sq.ft.                | 8,000/8,500 |
| Up to 20' x 30' Room | 600 sq.ft.                | 9,000/9,500 |

### NOTE: Match BTUs to room use and location:

- Shaded room reduce to next smaller size
- Sunny room increase to next larger size
- For kitchens, increase to next larger size

# Safety Instructions

## ⚠ WARNING

The length of the exhaust hose is specially designed according to the specification of the product. Do not replace, or extend, or otherwise modify the hose.

Vertical Sliding Window

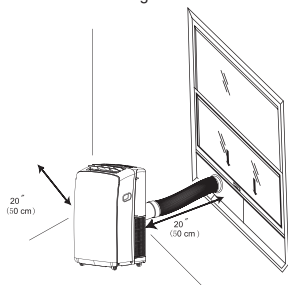

Horizontal Sliding Window

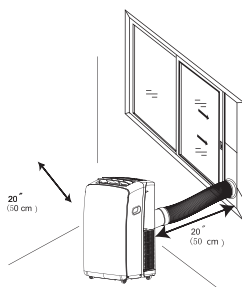

### NOTE:

- For best performance, allow at least 20 in of air space on all sides of the unit for good air circulation.
- Do not block the air outlet.
- Provide easy access to the grounded 3 prong outlet.

# Installation Instructions

## Unpack the Air Conditioner

### ⚠ WARNING

#### Excessive Weight Hazard

Use two or more people to move and install air conditioner.

Failure to do so can result in back or other injury.

Do not use sharp instruments, rubbing alcohol, flammable fluids, or abrasive cleaners to remove tape or glue. These products can damage the surface of your air conditioner.

Handle the air conditioner gently.

Keep unit upright at least 2 hours prior to use.

### Remove packaging materials

Remove and recycle packaging materials.

Remove tape and glue residue from surfaces before turning on the air conditioner. Rub a small amount of liquid dish soap over the adhesive with your fingers. Wipe with warm water and dry.

Caution: Installation accessories are stored in the top of the carton, and are required for proper cooling performance. Please remove all accessories from packing materials before use.

# Installation Instructions

## Install Exhaust Hose and Adapter

1. Roll the air conditioner to selected location. see "Location Requirements" in page 4.
2. Preparing the exhaust hose assembly:  
Press the coupling and the window exhaust adapter into the flexible exhaust hose. Both the coupling and window exhaust adapter have integral clips that snap onto the hose.

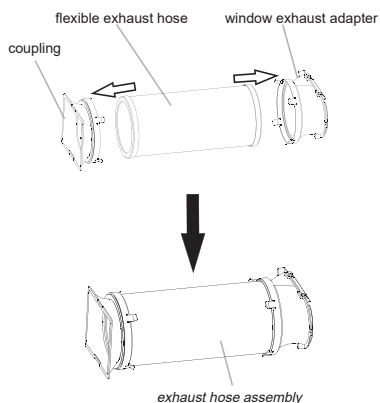

3. Insert the coupling into the slot on the back of the air conditioner.
4. Slide down to lock the hose into place.

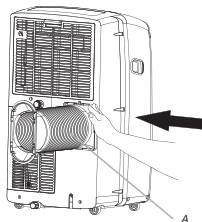

A. Flexible exhaust hose assembly

5. Confirm the hose is locked in place before operating.

## Window Installation

Your window installation kit has been designed to fit most standard vertical and horizontal window applications. Roll the air conditioner to selected location. see "Location Requirements" in page 4.

1. Attach the window exhaust adapter to the outer slider

**NOTE :** Product must be used with included Duct Window installation kit for effective cooling.

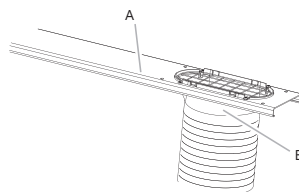

A. Outer slider section  
B. Window exhaust adapter

# Installation In Vertical Sliding Windows

Contents: Four (4) screws

Required Tools: Drill

NOTE: The window installation kit can be used with vertical sliding windows between 18" and 50" wide.

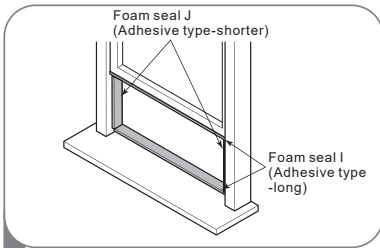

Cut the foam seal I (adhesive type-long) & J (adhesive type-shorter) to the proper length, and attach it to the window sash and frame.

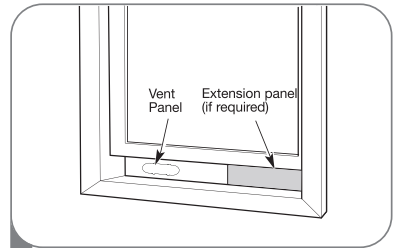

Insert the vent panel assembly, including extension panels, if needed, into the window opening. Extend the extension panels to the window width.

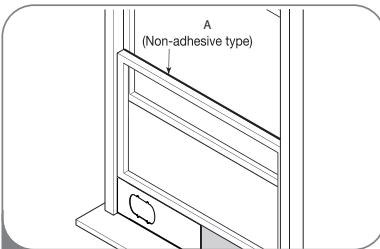

Cut the foam seal A (Non-adhesive type) to the window width. Stuff the foam seal A between the glass and the window to prevent air and foreign objects from getting into the room.

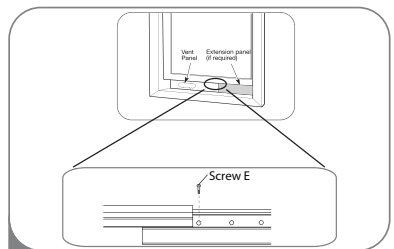

To secure extension panel and prevent panels from sliding, use enclosed screw. Insert screw through hole in extension panel as shown. Use hole that allows panel to best fit window opening. Tighten in place.

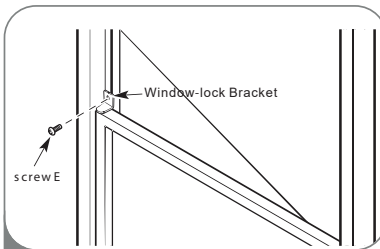

Install window lock bracket with 1 screw per bracket, as needed for secure installation.

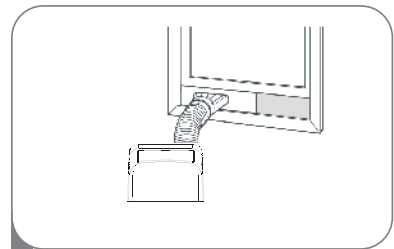

Insert the window exhaust adapter into the opening in the vent panel.



# Installation In Vertical Sliding Windows

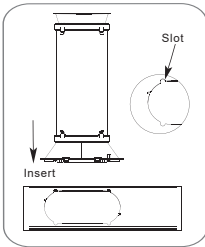

Align the tabs on the window exhaust adapter with the slots in the vent panel. Insert the window exhaust adapter into the opening in the vent panel.

# Installation In Horizontal Sliding Windows

**NOTE:** The window installation kit can be used with horizontal sliding windows between 18" and 50" wide.

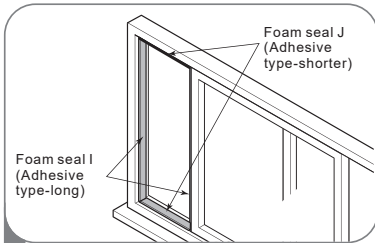

1

Cut the foam seal I (adhesive type-long) & J (adhesive type-shorter) to the proper length, and attach it to the window sash and frame.

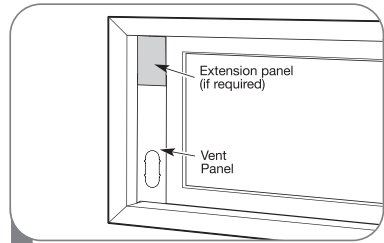

2

Insert the vent panel assembly, including extension panels, if needed, into the window opening. Extend the extension panels, if used.

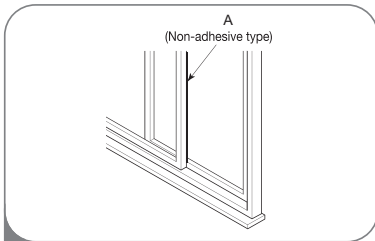

3

Cut the foam seal A (Non-adhesive type) to the window width. Stuff the foam seal A between the glass and the window to prevent air and foreign objects from getting into the room.

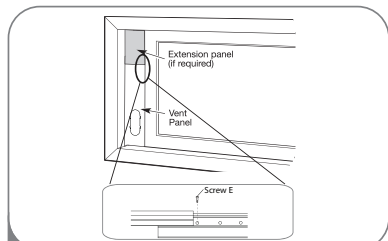

4

To secure extension panel and prevent panels from sliding, use enclosed screw. Insert screw through hole in extension panel as shown. Use hole that allows panel to best fit window opening. Tighten in place.

# Installation In Horizontal Sliding Windows

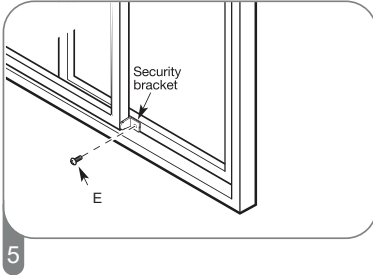

5 Install the Window-lock bracket with a type E screw as shown if you need.

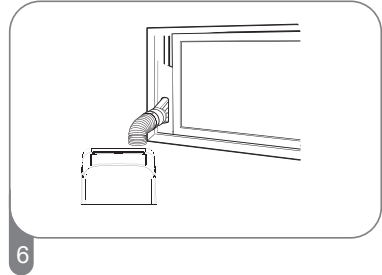

6 Insert the window exhaust adapter into the opening in the vent panel.

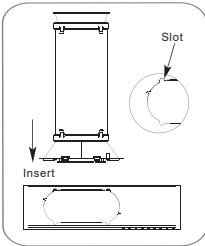

Align the tabs on the window exhaust adapter with the slots in the vent panel. Insert the window exhaust adapter into the opening in the vent panel.

## Portable Air Conditioner Use

Operating your portable air conditioner properly helps you to obtain the best possible results. This section explains proper air conditioner operation.

### IMPORTANT:

Do not stay in direct airflow from the air conditioner for extended periods of time.  
Never use in tightly enclosed spaces. Always ensure there is sufficient airflow of outside air entering the household especially when used in conjunction with combustible devices such as gas stoves, fireplaces, furnaces, hot water heaters etc. Do not place the power cord or air conditioner near a heater, radiator, stoves or other apparatus(including amplifiers) that produce heat.

This air conditioner is intended for household use as a residential appliance. Do not use it as a precision climate control for commercial use, or for precision equipment, food, pets, plants, artwork, etc.

Do not block or obstruct the exhaust vent hose as it may severely affect performance, or cause failure of the air conditioner.

The air conditioner display shows the current room temperature.

When changing modes while the air conditioner is in operation, the compressor will stop for 3 to 5 minutes before restarting. If a button is pressed during this time, the compressor will not restart for another 3 to 5 minutes.

In Cooling or Dry mode, the compressor and condenser fan will stop when the room temperature reaches the set temperature.

On Dry mode, the humidity level is automatically set, but is not able to be displayed.

NOTE: In the event of a power failure, your air conditioner will operate at the previous settings when the power is restored.

# Starting Your Portable Air Conditioner

## Control panel



**NOTE:**The symbols may be different from these models, but the functions are similar.

### Power On or Off



POWER

**NOTE:**  
Keep upright at least 2 hours before use to prevent damaging the compressor.

At the first time when the air conditioner is plugged in and turned on after your purchase, it will be set in Cool Mode. When the air conditioner is turned on at all other times, it will run according to the previous setting.

### Mode

1. Press and release MODE until you see the symbol for the desired setting.

Operating modes:



MODE

2. Choose Cool, Dry, Fan or Heat.

Cool-Cools the room, Press FAN to select High, Mid or Low speeds, Press the Plus or Minus button to adjust the temperature.



COOL

Dry-Dries the room. The air conditioner automatically selects the temperature. The fan runs on Low speed only. Dehumidification ranges between 2 to 3 pints per hour, by model.

**NOTE:** Dry mode should not be used to cool the room.



DRY

Fan Only mode. Press FAN to select High, Mid or Low.



FAN

Heat-heats the room, Press FAN to select high, Mid or Low speeds. Press the PLUS or MINUS button to adjust the temperature.

**NOTE:** Heating is NOT available for cooling only models.



HEAT (Optional)

### Fan Speed

1. Press and release FAN to choose the desired fan speed.



FAN

2. Choose High, Mid or Low.

High-for maximum fan speed



HIGH

Mid-for normal fan speed



MED

Low-for minimum fan speed



LOW

# Starting Your Portable Air Conditioner

## Temperature

Press the PLUS button to raise the temperature. Press the PLUS button once to increase the set temperature by 1°F (1°C).



Press the MINUS button to lower the temperature. Press the MINUS button once to decrease the set temperature by 1°F (1°C).



### NOTE:

- In the Cooling mode, the temperature can be set between 61°F and 86°F (16°C and 30°C).
- In Fan Only mode, the temperature can not be set.
- The unit LED shows the target temperature for 5 seconds and then displays the room temperature.

## Change display between °F and °C

To change the temperature display between °F and °C, press both the Plus and Minus Adjust buttons at the same time.



## ION (Optional)

Press the ION button to start or stop the Plasma Generator.



When the ION indicator light of the appliance flashes, the Plasma Generator will turn on.

# Using the Remote

## Insert the Batteries

1. Remove the battery cover along the arrowed direction.



2. Insert new batteries making sure that the (+) and (-) of battery are matched correctly.
3. Re-attach the cover by sliding it back into position.



### NOTE:

- Use 2 standard AAA(1.5volt) batteries. Do not use rechargeable batteries.
- Replace batteries with new ones of the same type when the display becomes dim, or after 6 months.
- When replacing batteries, always replace both batteries with new batteries. Do not mix old and new batteries. Do not mix alkaline, standard( carbon-zinc), or rechargeable (ni-cd, ni-mh, etc) batteries.
- If the air conditioner will not be used for an extended period of time, remove the batteries from the remote.

## CAUTION

- Do not use the remote if the batteries have leaked. The chemicals in batteries could cause burns or other health hazards.

## Storage Tip

The holder on the back of the unit can be used to store the remote control.

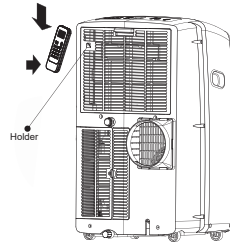

## How to Use

To operate the room air conditioner, aim the remote control at the signal receptor. The remote control will operate the air conditioner at a distance of up to 23'(7m) when pointing at signal receptor of the air conditioner.

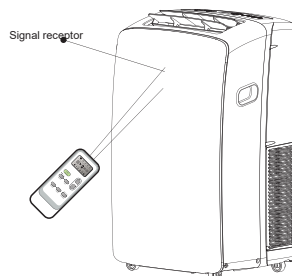

# Using the Remote

## Remote control

### NOTE :

Remote control may differ in appearance.

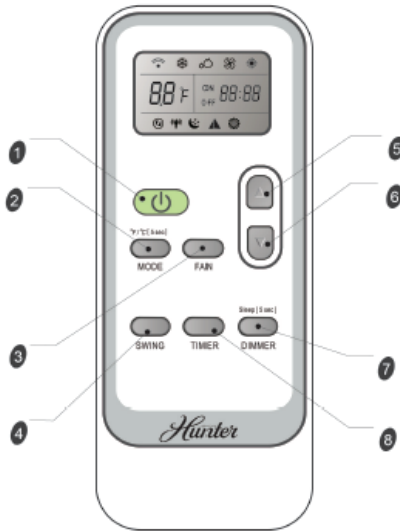

## Button and Function

|   |  |        |   |  |                 |
|---|--|--------|---|--|-----------------|
| 1 |  | ON/OFF | 5 |  | UP              |
| 2 |  | MODE   | 6 |  | DOWN            |
| 3 |  | FAN    | 7 |  | DIMMER or Sleep |
| 4 |  | SWING  | 8 |  | Timer On/Off    |

NOTE: Press and hold the MODE button on the remote for 5 seconds to switch the temperature display from degrees Fahrenheit (°F) to degrees Celsius (°C).

## Indication symbols

### Indication symbols on LCD:

|  |                    |  |                  |
|--|--------------------|--|------------------|
|  | Cooling indicator  |  | Auto fan speed   |
|  | Dry indicator      |  | High fan speed   |
|  | Fan only indicator |  | Medium fan speed |
|  | Heating indicator  |  | Low fan speed    |

|  |                         |
|--|-------------------------|
|  | Sleep indicator         |
|  | Signal transmit.        |
|  | Display set temperature |

# Using the Features

## DIMMER

Press the DIMMER button to turn off the control panel display.



### NOTE:

- When in DIMMER mode, new control inputs will return display to normal.

## Sleep mode

SLEEP mode can only be set in Cooling, Heating or Drying modes. When in sleep mode the unit will utilize lower, quieter fanspeeds and automatic temperature adjustments offering 8 hours of optimal sleeping conditions before shutting off.



### NOTE:

- The appliance will stop operation automatically after operating for 8 hours.
- Fan speed is automatically set at low speed.
- In the Cooling mode, if the current room temperature is below 79°F (26°C), the temperature will automatically increase 1°F (1°C) during the first hour after Sleep control is activated, and continue running at that temperature. If the room temperature is 79°F (26°C) or above, set temperature will not change.
- In Heating mode, the set temperature will decrease by 6°F (3°C) at most, during 3 hours, and continues running at that temperature until auto shut off.

1. Press MODE to select COOL, Heating or DRY.

NOTE : Sleep control cannot be selected in Fan mode.

2. Press the UP or DOWN button to set the temperature.
3. Press and hold the DIMMER button on the remote for 5 seconds to switch the DIMMER mode to the Sleep mode.

4. After 5 seconds, the lights on the control panel display will dim.

NOTE: The temperature and airflow direction may be adjusted during Sleep control. The fan speed is automatically set to Low speed. After 5 seconds, the lights on the control panel display will dim again.

5. To turn off Sleep control, press MODE, FAN, Sleep or wait 8 hours for Sleep control to turn off automatically.

NOTE: The air conditioner will return to previous settings after Sleep mode is turned off.

## TIMER

Use the TIMER function to turn the air conditioner ON/OFF automatically.



### Setting the Air Conditioner to Turn On:

1. Plug in the air conditioner and use the remote to power it ON.
2. Use the remote to set the desired mode, temperature, fan speed, etc.
3. Use the remote to power OFF the air conditioner.
4. Press TIMER on the remote and use the UP, DOWN buttons to set the desired delay time until the air conditioner turns ON. The delay time can be set from 0 to 24 hours in one-hour increments.
5. Press TIMER again to confirm the delay time. The TIMER light on the unit will be on.

### Setting the Air Conditioner to Turn OFF:

1. Plug in the air conditioner and use the remote to power it ON.
2. Use the remote to set the desired mode, temperature, fan speed, etc.
3. Press TIMER on the remote and use the UP, DOWN buttons to set the desired delay time until the air conditioner turns OFF. The delay time can be set from 0 to 24 hours in one-hour increments.
4. Press TIMER again to confirm the delay time. The TIMER light on the unit will be on.

### To cancel TIMER :

Press the TIMER button again. Once a "beep" is heard and the indicator disappears, the TIMER mode has been canceled.

### NOTE:

- The TIMER function can only be set by the remote control.

## SWING

Press SWING once to change the vertical airflow direction. Press again to hold the louver in a desired position.



### NOTE :

- Airflow is automatically adjusted to a preset direction after turning on the unit.
- The direction of airflow can be adjusted by pressing the SWING button.
- Do not turn the airflow louvers manually, to prevent damage, turn off the unit first and cut off the power supply. Then restore power again after adjustment.

## Normal Sounds

When your air conditioner is operating normally, you may hear sounds such as:

- Air movement from the fan.
- Clicks from the thermostat cycling.
- Vibration or noise due to poor wall or window construction.
- A high-pitched hum or pulsating noise caused by the high-efficiency compressor cycling on and off.

# Dehumidification & Draining

## COOL MODE

Excess moisture is vented through exhaust hose **E** and out window in **COOL MODE**. No additional parts are needed if room humidity remains under 92%.

### USER NOTICE

Excessive room humidity may cause internal water reservoir to fill up. LED screen will display E5 and automatically shut off.

Refer to Page 14 of User Manual for draining instructions.

If operating in a room with excessive humidity over 92%, refer to **DRAIN HOSE KIT** for continuous use.

### USER NOTICE

Air Conditioner does NOT display or determine room humidity. Please use other method to determine humidity in your home.

## HEAT MODE (For Heat Models Only)

Drain Hose Kit (included with heat models) must be used during **HEAT MODE**. Connect to Primary Drain Port **C**.

### USER NOTICE

Always connect drain hose on **HEAT MODE** or unit will stop running after water tank is full.

## DRY MODE

(Not applicable for Hunter 8K BTU Conditioner)

When using **DRY MODE**, remove exhaust hose from window.

Drain air conditioner into a bucket using Secondary Drain Port **D**. When using this method, monitor air conditioner to ensure unit is not leaking.

For your convenience, a Drain Hose Kit is available to purchase for continuous drainage.

### USER NOTICE

Humidity levels cannot be adjusted with the dehumidification feature and does NOT replace a dehumidifier. For optimal humidity, we recommend purchasing a Hunter Dehumidifier.

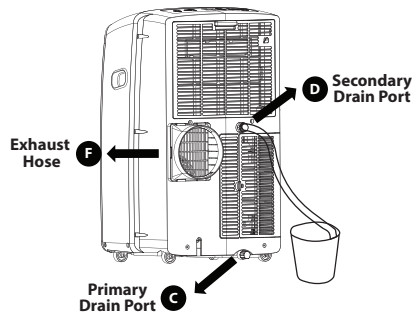

## DRAIN HOSE KIT

Your Drain Hose Kit should include a drain hose and clip. Use Primary Drain Port **C** if used for **COOL MODE** or **HEAT MODE**. Use Secondary Drain Port **D** if used for **DRY MODE**.

### Attaching the Hose:

1. Unplug or disconnect power.
2. Remove drain plug from proper draining port.
3. Attach drain hose and clip to drain plug.
4. Place other end of hose into a drain location. Ensure this end is on a lower level than end of hose attached to unit. Hose should not be kinked or pinched.
5. Plug in or reconnect power.



For your convenience, Drain Hose Kit (HPAC-HOSE) is available to purchase at [hunterpureair.com](http://hunterpureair.com) or by calling Customer Service at (855) 887-1440.

# Portable Air Conditioner Use

## Draining the Air Conditioner(non-Heating models)

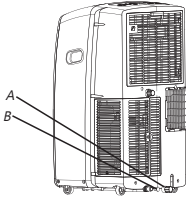

A,Primary drain cover B.Primary drain plug

### ⚠ WARNING

#### Excessive Weight Hazard

Use two or more people to move and install the air conditioner.

Failure to do so can result in back or other injury.

1. Unplug the air conditioner or disconnect power.
2. Move the air conditioner to a drain location or outside.

NOTE: To avoid leaking water from the unit, move the air conditioner slowly and keep it level.

3. Remove the primary drain cover and plug.
4. Drain water completely through the drain hole.

NOTE : If the air conditioner will be stored after use, see "Storing After Use".

5. Reinstall the drain plug to the primary drain hole.
6. Reinstall the primary drain cover to the drain hole.
7. Reposition the air conditioner.
8. Plug in the air conditioner or reconnect power.

## Draining the Air Conditioner(Heating models)

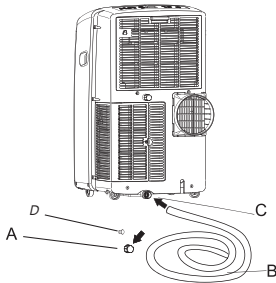

A.Primary drain port  
B.Drain hose  
C.Primary drain hole  
D.Primary drain plug

WARNING: Please connect the drain hose on heating mode, or the unit will stop running after the water the water reaches warning level.

1. Uncover the primary drain port.
2. Attach the drain hose to the primary drain hose. Make sure the connector has no water leak.
3. Place the other end of drain hose into a outfall. Check to see that the hose lies flat and is in the drain. Make sure the hose end that goes to the drain is on a lower level than the hose end that connects to the unit. The hose should not be kinked or pinched.

### Cleaning the Outside

1. Press ON/OFF to turn off the air conditioner.
2. Unplug the air conditioner or disconnect power.
3. Remove the air filter and clean separately. See "cleaning the Air Filter . "
4. Wipe the outside of the air conditioner with a soft, damp cloth.
5. Plug in the air conditioner or reconnect power.
6. Press ON/OFF to start the air conditioner.

### Cleaning the Air Filter

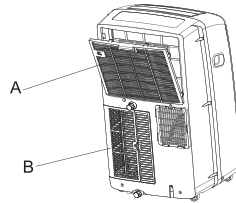

A.Evaporator air intake filter panel door  
B.Condenser air intake filter panel door

1. Press ON/OFF to turn off the air conditioner.
2. Open the filter panel door on the back of the air conditioner and remove.
3. Remove the tapping screw from the condenser air intake filter panel door and remove.
4. Use a vacuum cleaner to clean the filter. If the filter is very dirty, wash the filter in warm water with a mild detergent. NOTE : Do not wash the filter in the dishwasher or use any chemical cleaners.
5. Air dry the filter completely before replacing to ensure maximum efficiency.
6. Reattach the air filter to the filter panel door.
7. Reinstall the filter panel door and tapping screw.
8. Press ON/OFF to start the air conditioner.

### Storing After Use

If the air conditioner will not be used for an extended period of time:

1. Drain the water completely. See "Draining the Air Conditioner. "
2. Run the air conditioner set to Fan Only for approximately 12 hours to dry the air conditioner.
3. Unplug the air conditioner.



# Using the Remote

- Remove the flexible exhaust hose and store with the air conditioner in a clean, dry area. See "Installation Instructions."
- Remove the window kit and store with the air conditioner in a clean, dry area. See "Installation Instructions."
- Remove the filter and clean. See "Cleaning the Air Filter."
- Clean the outside of the air conditioner. See "Cleaning the Outside."
- Reinstall the filter.
- Remove the batteries and store the remote control with the air conditioner in a clean, dry area.  
Before using the air conditioner again:
  - Make sure the filter and drain cap are in place.
  - Check the power cord to make sure it is in good condition, with no cracks or damage.
  - Place new batteries in the remote.
  - Install the air conditioner. See "Installation Instructions".

## Troubleshooting

Before calling for service, please try the suggestions below.

Air conditioner will not operate

**WARNING**

**Electrical Shock Hazard**

Plug into a grounded 3 prong outlet.  
Do not remove ground prong.  
Do not use an adapter.  
Do not use an extension cord.  
Failure to follow these instructions can result in death, fire, or electrical shock.

- The power supply cord is unplugged.**  
Plug into a grounded 3 prong outlet. See "Electrical Requirements."
- Time-delay fuse or circuit breaker of the wrong capacity is being used.**  
Replace with a time-delay fuse or circuit breaker of the correct capacity. See "Electrical Requirements."
- The power supply cord has tripped (Reset button has popped out).**  
Press and release RESET (listen for click; Reset button will latch and remain in) to resume operation.
- A household fuse has blown, or a circuit breaker has tripped.**  
Replace the fuse, or reset the circuit breaker. See "Electrical Requirements".
- The On/Off button has not been pressed.**  
Press ON/OFF.
- The local power has failed.**  
Wait for power to be restored.

Air conditioner blows fuses or trips circuit breakers

- Too many appliances are being used on the same circuit.**  
Unplug or relocate appliances that share the same circuit.
- You are trying to restart the air conditioner too soon after turning off air conditioner.**  
Wait at least 3 minutes after turning off air conditioner before trying to restart the air conditioner.

Air conditioner power supply cord trips (Reset button pops out)

- Disturbances in your electrical current can trip (Reset button will pop out) the power supply cord.**  
Press and release RESET (listen for click; Reset button will latch and remain in) to resume operation.
- Electrical overloading, overheating, cord pinching or aging can trip (Reset button will pop out) the power supply cord.**  
After correcting the problem, press and release RESET (listen for click; Reset button will latch and remain in) to resume operation. If the power cord fails to reset, contact a service technician.

**NOTE:** A damaged power supply cord must be replaced with a new power supply cord obtained from the product manufacturer and must not be repaired.

Air conditioner seems to run too much

- Is there a door or window open?**  
Keep doors and windows closed.
- The current air conditioner replaced an older model.**  
The use of more efficient components may cause the air conditioner to run longer than an older model, but the total energy consumption will be less. Newer air conditioners do not emit the "blast" of cold air you may be accustomed to from older units, but this is not an indication of lesser cooling capacity or efficiency. Refer to the efficiency rating (EER) and capacity rating (in Btu/h) marked on the air conditioner.
- The air conditioner is in a heavily occupied room, or heat-producing appliances are in use in the room.**  
Use exhaust vent fans while cooking or bathing and try not to use heat-producing appliances during the hottest part of the day. Portable air conditioners are designed as supplemental cooling to local areas within a room. A higher capacity air conditioner may be required, depending on the size of the room being cooled.

Air conditioner runs for a short time only, but room is not cool

- Set temperature is close to room temperature.  
Lower set temperature. See "Portable Air Conditioner Use."

# Troubleshooting

---

## Display error code

---

- If the unit displays error code E5, the water container is full.  
Drain the water, see "Draining the Air Conditioner ." After draining, the unit can be operated again.
- If the unit display error code E1/E2/E3/E4/E6/E7/EA please contact customer service.

---

## Air conditioner runs , but does not cool

---

- **The filter is dirty or obstructed by debris.**  
Clean the filter.
- **Air outlet is blocked.**  
Clear air outlet.
- **Set temperature is too high.**  
Lower set temperature.

---

## Air conditioner cycles on and off too much

---

- **The air conditioner is not properly sized for your room.**  
Check the cooling capabilities of your portable air

conditioner. Portable air conditioners are designed as supplemental cooling to local areas within a room.

- **The filter is dirty or obstructed by debris.**  
Clean the filter.
- **There is excessive heat or moisture, open container cooking, showers, etc. in the room.**  
Use a fan to exhaust heat or moisture from the room. Try not to use heat-producing appliances during the hottest part of the day.
- **The louvers are blocked.**

Install the air conditioner in a location where the louvers are free from curtains, blinds, furniture, etc.

# Warranty

## 1 YEAR LIMITED WARRANTY

Your appliance is covered by a limited one-year warranty and a limited 2-5 year warranty on the sealed system (the compressor, condenser, evaporator and tubing). For one year from your original date of purchase, Mindful, LLC will pay all costs for repairing or replacing any parts of this appliance that prove to be defective in materials or workmanship when such appliance is installed, used and maintained in accordance with the provided instructions. You will be responsible for insurance and freight or other transportation to our factory service center. We will return the portable air conditioner freight prepaid. The portable air conditioner should be properly packaged to avoid damage in transit since we will not be responsible for any such damage. Proof of purchase is required when requesting warranty service. From the second to the fifth year from your original purchase date, Mindful, LLC will repair or replace any parts in the Sealed Refrigeration System (compressor, condenser, evaporator and tubing) that prove to be defective in materials or workmanship. In years 2-5, the consumer will be responsible for diagnostic, labor and parts costs as well as any removal, transportation and reinstallation expenses which are incurred during service on components other than those covered under the Sealed Refrigeration System 5-year warranty.

### Exclusions: This warranty does not cover the following

1. Products with original serial numbers that have been removed, altered or cannot be readily determined.
2. Product that has been transferred from its original owner to another party or removed outside the USA or Canada.
3. Rust on the interior or exterior of the unit.
4. Products purchased "as-is" are not covered by this warranty.
5. Food loss due to any refrigerator or freezer failures.
6. Products used in a commercial setting.
7. Service calls which do not involve malfunction or defects in materials or workmanship, or for appliances not in ordinary household use or used other than in accordance with the provided instructions.
8. Service calls to correct the installation of your appliance or to instruct you how to use your appliance.
9. Expenses for making the appliance accessible for servicing, such as removal of trim, cupboards, shelves, etc., which are not a part of the appliance when it is shipped from the factory.
10. Service calls to repair or replace appliance light bulbs, air filters, water filters, other consumables, or knobs, handles, or other cosmetic parts.
11. Surcharges including, but not limited to, any after hour, weekend, or holiday service calls, tolls, ferry trip charges, or mileage expense for service calls to remote areas, including the state of Alaska.
12. Damages to the finish of appliance or home incurred during installation, including but not limited to floors, cabinets, walls, etc.
13. Damages caused by: services performed by unauthorized service companies; or external causes such as abuse, misuse, inadequate power supply, accidents, fires, or acts of God.
14. Insurance and freight or other transportation to our factory service center. The portable air conditioner should be properly packaged to avoid damage in transit since Mindful, LLC will not be responsible for any such damage.

**DISCLAIMER OF IMPLIED WARRANTIES; LIMITATION OF REMEDIES**  
**CUSTOMER'S SOLE AND EXCLUSIVE REMEDY UNDER THIS LIMITED WARRANTY SHALL BE PRODUCT REPAIR OR REPLACEMENT AS PROVIDED HEREIN. CLAIMS BASED ON IMPLIED WARRANTIES, INCLUDING WARRANTIES OF MERCHANTABILITY OR FITNESS FOR A PARTICULAR PURPOSE, ARE LIMITED TO ONE YEAR OR THE SHORTEST PERIOD ALLOWED BY LAW, BUT NOT LESS THAN ONE YEAR. MINDFUL, LLC SHALL NOT BE LIABLE FOR CONSEQUENTIAL OR INCIDENTAL DAMAGES SUCH AS PROPERTY DAMAGE AND INCIDENTAL EXPENSES RESULTING FROM ANY BREACH OF THIS WRITTEN LIMITED WARRANTY OR ANY IMPLIED WARRANTY. SOME STATES AND PROVINCES DO NOT ALLOW THE EXCLUSION OR LIMITATION OF INCIDENTAL OR CONSEQUENTIAL DAMAGES, OR LIMITATIONS ON THE DURATION OF IMPLIED WARRANTIES, SO THESE LIMITATIONS OR EXCLUSIONS MAY NOT APPLY TO YOU. THIS WRITTEN WARRANTY GIVES YOU SPECIFIC LEGAL RIGHTS. YOU MAY ALSO HAVE OTHER RIGHTS THAT VARY FROM STATE TO STATE.**

### If you need service:

Keep your receipt, delivery slip, or some other appropriate payment record to establish the warranty period should service be required. If service is performed, it is in your best interest to obtain and keep all receipts. Service under this warranty must be obtained by contacting Mindful, LLC at 1-855-887-1440.

This limited warranty only applies in the USA and Canada. Mindful, LLC authorizes no person to change or add to any obligations under this warranty. Obligations for service and parts under this warranty must be performed by Mindful, LLC or an authorized Hunter service company. Product features or specifications as described or illustrated are subject to change without notice.