

HEPAtech[®]

Small UVC Tower

Owner's Manual

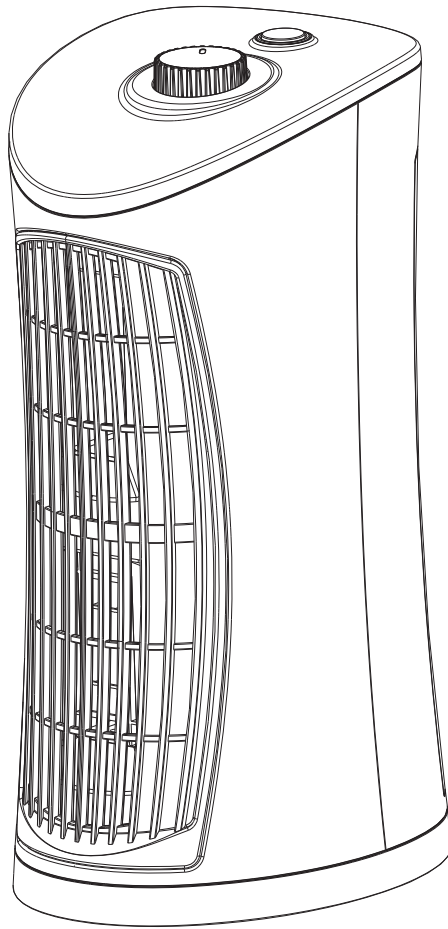

English

Model
40882

44114-01
20140801

©2014[®] Registered Trademark/TM Trade mark of Hunter Fan Co.
Manufactured under license by Master Brands H.K.
All rights reserved

Hunter[®]
SINCE 1886

Table of Contents

- At a Glance
 - Introduction and Warnings 3
 - How it Works 5
- Using Your Air Purifier
 - Initial Setup 6
 - Operation 7
- Maintenance
 - Cleaning the Unit 7
 - Cleaning the Pre-filter 8
 - Cleaning the Filter 8
 - Replacing the UVC Bulb 8
 - Order Replacement Parts 10
 - Troubleshooting and Support 10
 - Storage 10
- Warranty
 - 1 Year Limited Warranty 11

At a Glance

INTRODUCTION:

Thank you for purchasing the HEPAtch® Small UVC Tower. You have purchased our latest development in air purifiers. This system has been developed to improve the quality of the air you breathe.

Our HEPAtch® Small UVC Tower out performs other air purifiers by quickly and effectively removing dust, smoke, and pollen particles as small as 0.3 microns in size. The following innovative features are included in your Hunter Air Purifier.

- 🗑️ **High Particulate Efficiency:** The HEPAtch® filter will remove up to 99.9% of particles as small as 0.3 micron particles from the air that passes through the filter.
- 🗑️ **Washable Pre-Filter:** The washable pre-filter is permanent and can be cleaned and reused.
- 🗑️ **UVC Lamp:** This HEPAtch® Small UVC Tower is equipped with a UVC germicidal lamp. UVC technology is a proven germicide that is accepted by the FDA and EPA as having the ability to kill pathogens in air that are exposed to UVC light.
- 🗑️ **Photocatalytic Oxidation:** Reduces the amount of toxic VOCs in the air caused by household cleaners and products.

<p>IMPORTANT SAFETY INSTRUCTIONS! READ AND SAVE ALL INSTRUCTIONS BEFORE USING THIS AIR PURIFIER.</p> <p>⚠️ WARNING! RISK OF ELECTRIC SHOCK ⚠️</p>

1. **WARNING:** This air purifier emits UVC radiation that may cause eye and/or skin irritation. RG-3. Avoid exposing eyes and skin to unshielded UVC Lamp.
2. **Caution:** The UVC Lamp may shatter and cause injury if it is dropped or sustains impact. Wear safety glasses and gloves when handling the UVC Lamp. Do not use excessive force when handling the UVC Lamp. Dispose of the UVC bulb in accordance with local or state guidelines as trace amounts of mercury are present.
3. This air purifier is designed for use on a level floor and may not work properly on an uneven floor. **ALWAYS** place the air purifier on a firm, level floor. **ALWAYS** place the air purifier at least six (6) inches away from walls and heat sources such as stoves, radiators, or heaters.

At a Glance (continued)

4. Place the air purifier in an area that is out of the reach of children.
5. Before using the air purifier, extend the cord and inspect for any signs of damage. DO NOT use the product if the cord has been damaged.
6. To reduce the risk of electric shock, this product has a polarized plug (one blade is wider than the other) as a safety feature. This plug will fit into a polarized outlet only one way. If the plug does not fit fully into the outlet, reverse the plug. If it still does not fit, contact a qualified electrician. DO NOT attempt to defeat or override this safety feature.
7. ALWAYS UNPLUG the air purifier while it is being cleaned.
8. DO NOT move or tilt the air purifier while it is in operation. Turn off and unplug before moving.
9. DO NOT immerse the air purifier in water at any time because permanent damage will occur. To properly clean your air purifier, follow the instructions in the Maintenance section of this manual "Cleaning the Unit" on page 7.
10. This equipment should be inspected frequently and collected dirt removed from it regularly to prevent excessive accumulation that could result in flashover or risk of fire.
11. Do not run cord under carpeting. Do not cover cord with throw rugs, runners, or similar coverings. Do not route cord under furniture or appliances. Arrange cord away from traffic area and where it will not be tripped over.

 **WARNING!** To Reduce The Risk Of Fire Or Electric Shock,
Do Not Use This Fan With Any Solid-State Speed Control Device.

At a Glance (continued)

HOW IT WORKS:

The HEPAtech® Small UVC Tower can help rid your home of dust and dangerous pollutants in the air. This unit features a permanent Photocatalyst Filter, UVC Germicidal Lamp, and HEPAtech® filter to help rid the air of unwanted airborne pollutants, allergens and odors and create a cleaner environment. With the unit's 60 Clean Air Delivery Rating, you can be confident that your air will be clean and odor free. Three speed settings Low, Medium, High, and optional UVC Lamp, this unit is powerful enough for any room in your home or office.

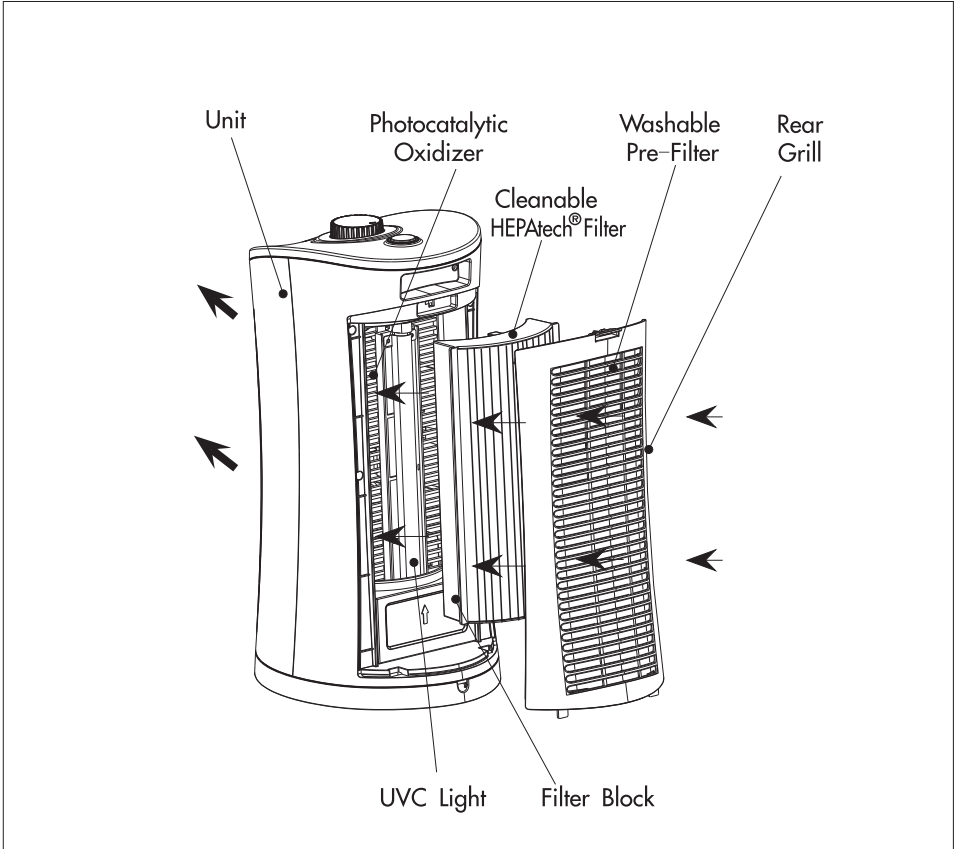

Using Your Air Purifier

INITIAL SETUP:

Your air purifier was thoroughly inspected and tested at the factory prior to packaging. Visually inspect it upon removal from its box. Remove and discard any packaging material. Return the unit if it shows any signs of damage or mishandling.

1. Take the air purifier out of the box and remove the clear plastic protective bag and place the unit on a firm, level surface.
2. Before turning on the air purifier, you need to confirm that the filters are firmly in place and have not become loose during shipping.
3. Remove the *rear grill* on the back of the unit by gently pulling the *removal tabs* away from the unit and lift the *rear grill* away. Figure 1.
4. The washable *pre-filter* is mounted inside the *rear grill* of the unit. Confirm that it properly covers the grill vents. Figure 2.
5. The HEPAtech® *filter* will be resting inside the unit. If present, remove the plastic bag surrounding the *filter* and place the *filter* back into the air purifier. The *filter* should have an *arrow* on the side to indicate air flow and the direction the *filter* should be placed back into the unit. The *arrow* should point toward the front of the unit. Figure 3.
6. Set the *lower tabs* on the bottom of the *rear grill* into the *lower notches* (figure 5) in the base of the unit and rock the *rear grill* up until the *top tabs* snap into place. Figure 1.
7. Plug the unit into a 120V electrical outlet.

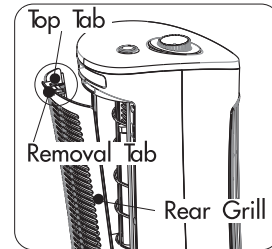

Figure 1

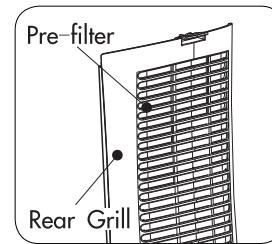

Figure 2

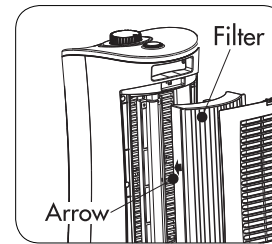

Figure 3

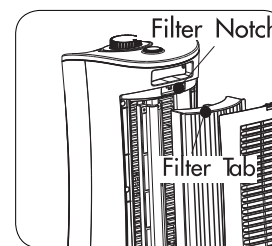

Figure 4

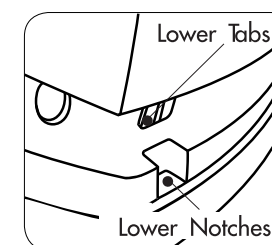

Figure 5

Using Your Air Purifier (continued)

OPERATION:

OFF – Unit off

LOW speed – Recommended for use when soft background noise is unwanted.

MED speed – Typical usage setting. Soft background noise is not an issue.

HI speed – Use when quick, efficient results to a room's air quality are desired.

The fan speed can be adjusted at any time by rotating the dial so the dial indicator aligns with the desired speed.

Press the *UVC On/Off* button to turn on and off the UVC function of your air purifier.

NOTE: The UVC indicator is a blue light that lets you know that the UVC bulb is working.

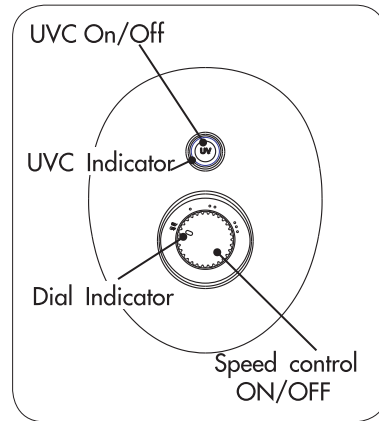

Figure 6

Maintenance

CLEANING THE UNIT:

⚠ WARNING! To avoid serious injury from electric shock ALWAYS turn the air purifier OFF and disconnect the plug from the outlet BEFORE cleaning.

Clean the outside of the unit with a soft, damp cloth. The rear grill can be cleaned in soapy water after it has been removed from the unit and the pre-filter has been removed.

NOTE: Ensure the grill is completely dry before reinstalling it on the unit. Failure to do so could cause damage to the filters or motor.

CLEANING THE PRE-FILTER:

1. Turn the air purifier off and disconnect from the wall outlet.
2. Remove the *rear grill* on the back of the unit by gently pulling the *removal tabs* away from the unit and lift the *rear grill* away. Figure 7.

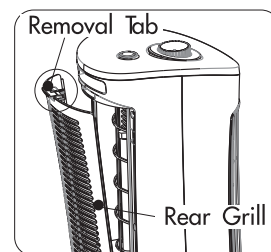

Figure 7

Maintenance (continued)

3. Gently remove the *pre-filter* from the rear grill, by carefully removing it from the *filter supports* that secure it to the rear grill. Figure 8.
4. Check the side of the *pre-filter* facing the rear grill for particle coverage.
5. If the *pre-filter* needs to be cleaned, it may be submerged in warm soapy water to clean. Gently lift and submerge the *pre-filter* several times to clean.
6. When complete, rinse the *pre-filter* with warm water and allow to dry completely.

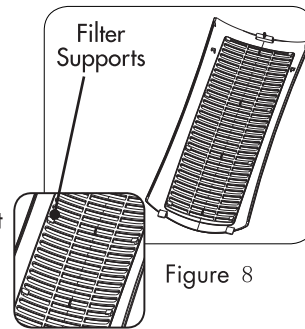

Figure 8

Note: Wet parts placed into the unit can cause damage to the filters and or the motor of the air purifier

7. Reinstall the *pre-filter*.
8. Replace the rear grill. The unit is now ready for normal operation.

CLEANING THE FILTER:

1. Turn the air purifier off and disconnect from the outlet.
2. Remove the rear grill on the back of the unit by gently pulling the *removal tabs* away from the unit and lift the rear grill away. Figure 7.
3. Remove the filter from the unit. Note the directional arrow printed on the side of the filter. The filter will be reinstalled with the same orientation. Figure 9.
4. With a vacuum cleaner and upholstery brush attachment, clean the filter until all particles are removed. Do not use water or liquids to clean the HEPAtech® filter.
5. Reinstall the filter.
6. Replace the rear grill. The unit is now ready for normal operation.

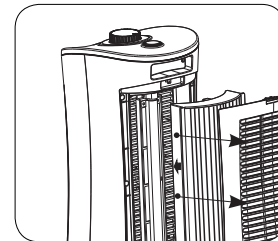

Figure 9

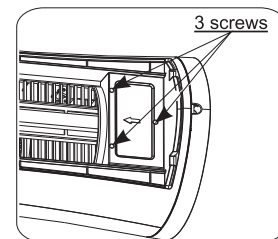

Figure 10

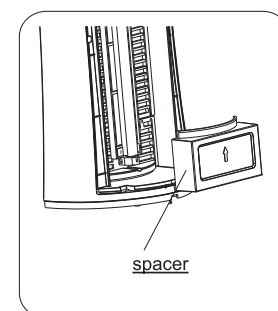

Figure 11

REPLACING THE UVC BULB:

Follow these instructions to remove and replace the UVC bulb.

1. Unplug the unit from the wall outlet.
2. Remove the rear grill on the back of the unit by gently pulling the *removal tabs* away from the unit and lift the rear grill away. Figure 7.

Maintenance (continued)

3. Remove the HEPAtech® filter. Figure 9.
4. Remove the 3 mounting screws holding the spacer in place. Figure 10.
5. Remove the spacer. Figure 11.
6. Using a small Phillips screwdriver remove the four mounting screws holding the UVC Cover in place. Figure 12.
7. Remove the two black insulators covering each end of the the bulb. Figure 13.
8. Grasping the two ceramic ends of the UVC bulb, twist bulb approximately one-quarter turn in either direction to allow the pins to lineup with the exit groove and allowing the bulb to be removed. Figure 14.
9. Remove the new UVC bulb from its packaging being careful not to let the bulb come in contact with your skin.

Note: Oils from your skin can cause damage to the bulb and will prevent it from working.

10. Using the bag the bulb came in, to prevent skin contact with the bulb, insert the new UVC bulb into the bulb mounts. Figure 14. Once the bulb is pressed firmly into the mounts at both ends, twist the bulb approximately one-quarter turn in either direction until bulb is secured. Discard the bag.
11. Reinstall the two black insulators. Figure 13.
12. BE SURE to reinstall the UVC cover using the four mounting screws. Figure 15.
13. Reinstall the spacer using the 3 mounting screws. Figure 10.
14. Replace the HEPAtech® filter.
15. Replace the rear grill.

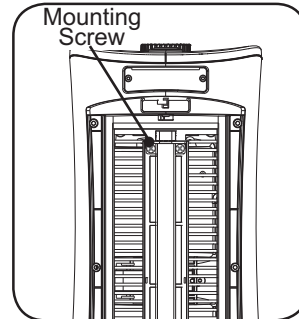

Figure e 12

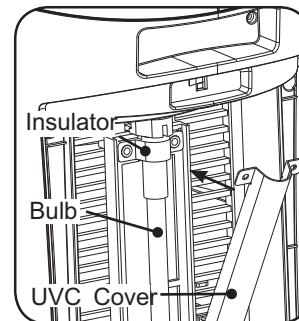

Figure e 13

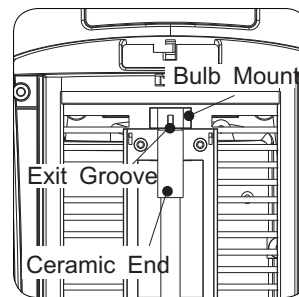

Figure e 14

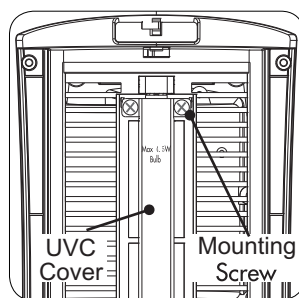

Figure e 15

Maintenance (continued)

TROUBLESHOOTING:

Problem: No Operation.

Solution: Confirm that the unit is plugged in.

- ☒ Check the installation of the *rear grill*
- ☒ Check the installation of the *UVC cover*.

Problem: Unit has reduced air flow or increased noise.

Solution: The filter may be clogged or need to be cleaned.
See “Cleaning the Filter” on page 8.

Problem: The UVC *bulb* is not operating.

Solution: Check the installation of the UVC *bulb*.

- ☒ Replace the UVC bulb. See “Replacing the UVC bulb” on page 9.

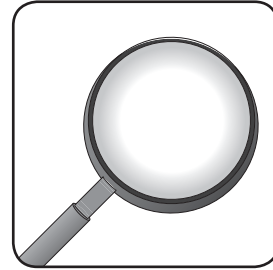

ORDER REPLACEMENT PARTS

<i>Model</i>	<i>Part #</i>
40882	
<i>Cleanable HEPAtech® Filter</i>	30611
<i>Pre-filter</i>	30901
<i>UV Bulb</i>	30403

Replacement parts are available at most retailers that carry Hunter Air Purifiers. You may also purchase them directly from Master Brands H.K.:

1-855-887-1440
www.HunterPureAir.com

TECHNICAL SUPPORT:

If you need any assistance with setup, operation, or parts for your new HEPAtech® Small UVC Tower, please call us, our technical support staff is ready to help!

USA & Canada: 1-855-887-1440

Hours of operation are from 7:00 am to 7:00 pm Monday – Friday and 8:00 am to 5:00 pm on Saturday, Central Time. You may also contact us on the Internet at www.HunterFan.com or www.HunterPureAir.com



Warranty

Hunter Air Purifier

1 YEAR LIMITED WARRANTY

Master Brands H.K. makes the following limited warranty to the original residential user or consumer purchaser of the Air Purifier with a cleanable HEPAtech® filtration:

If any part of your Air Purifier motor fails during the first one (1) year from the date of installation due to a defect in material or workmanship, we will provide a replacement Air Purifier free of charge. Installation is deemed to occur at the date of purchase.

If the Air Purifier cord or bottom filter panel fails any time within six (6) months after installation due to a defect in material or workmanship, we will replace or, at our option, repair the unit free of charge at our nearest service center. You will be responsible for all parts and labor costs after this one-year period.

IF THE ORIGINAL RESIDENTIAL USER OR CONSUMER PURCHASER CEASES TO OWN THE AIR PURIFIER, THIS WARRANTY AND ANY IMPLIED WARRANTY WHICH THEN REMAINS IN EFFECT, INCLUDING BUT NOT LIMITED TO ANY IMPLIED WARRANTY OF MERCHANTABILITY OR FITNESS FOR A PARTICULAR PURPOSE, ARE VOIDED. NO WARRANTY, EXPRESSED OR IMPLIED, INCLUDING ANY WARRANTY OF MERCHANTABILITY OR FITNESS FOR A PARTICULAR PURPOSE, IS MADE IN RESPECT TO THE FILTER MATERIAL OR CARBON FILTER. THIS WARRANTY IS IN LIEU OF ALL OTHER EXPRESS WARRANTIES. THE DURATION OF ANY IMPLIED WARRANTY, INCLUDING BUT NOT LIMITED TO ANY IMPLIED WARRANTY OF MERCHANTABILITY OR FITNESS FOR A PARTICULAR PURPOSE, IN RESPECT TO THE MOTOR IS EXPRESSLY LIMITED TO THE PERIOD OF THE EXPRESS WARRANTY SET FORTH ABOVE.

This warranty is voided if the air purifier is not purchased and used in the USA or Canada.

This warranty excludes and does not cover defects, malfunctions or failures of the Air Purifier which were caused by repairs by persons not authorized by us, use of parts or accessories not authorized by us, mishandling, modifications, or damage to the Air Purifier while in your possession, or unreasonable use, including failure to provide reasonable and necessary maintenance. This warranty does not cover Air Purifiers used in commercial applications. There are no express or implied warranties as to commercial purchasers or users.



Warranty (continued)

To obtain service, contact the nearest Hunter authorized service center or contact Master Brands H.K. at 1-855-887-1440 for the name of our nearest authorized Hunter Service Center. You will be responsible for insurance and freight or other transportation to our factory service center. We will return the air purifier freight prepaid. The air purifier should be properly packaged to avoid damage in transit since we will not be responsible for any such damage. Proof of purchase is required when requesting warranty service. The purchaser must present sales receipt or other document that establishes proof of purchase.

IN NO EVENT SHALL MASTER BRANDS H.K. BE LIABLE FOR DIRECT, INDIRECT, SPECIAL CONSEQUENTIAL OR INCIDENTAL DAMAGES IN EXCESS OF THE PURCHASE PRICE OF THE AIR PURIFIER. YOUR SOLE REMEDY WILL BE REPAIR OR REPLACEMENT AS PROVIDED ABOVE. SOME AMERICAN STATES AND CANADIAN PROVINCES DO NOT ALLOW LIMITATIONS ON HOW LONG AN IMPLIED WARRANTY LASTS, SO THE ABOVE LIMITATION MAY NOT APPLY TO YOU.

SOME AMERICAN STATES AND CANADIAN PROVINCES DO NOT ALLOW THE EXCLUSION OR LIMITATION OF DIRECT, INDIRECT SPECIAL, INCIDENTAL OR CONSEQUENTIAL DAMAGES, SO THE ABOVE LIMITATION MAY NOT APPLY TO YOU. SOME AMERICAN STATES AND CANADIAN PROVINCES DO NOT ALLOW THE EXCLUSION OR INVALIDITY OF EXPRESS OR IMPLIED WARRANTIES IF THE USER CEASES TO OWN THE AIR PURIFIER, SO THE ABOVE LIMITATION MAY NOT APPLY TO YOU.

THIS WARRANTY GIVES YOU SPECIFIC LEGAL RIGHTS, AND YOU MAY ALSO HAVE OTHER RIGHTS WHICH VARY FROM STATE TO STATE OR PROVINCE TO PROVINCE.

