

SISTEMA DE MONTAJE DE 2 FILAS DE 2 PANELES  
VERTICALES DE +500W INCLINADO 20°

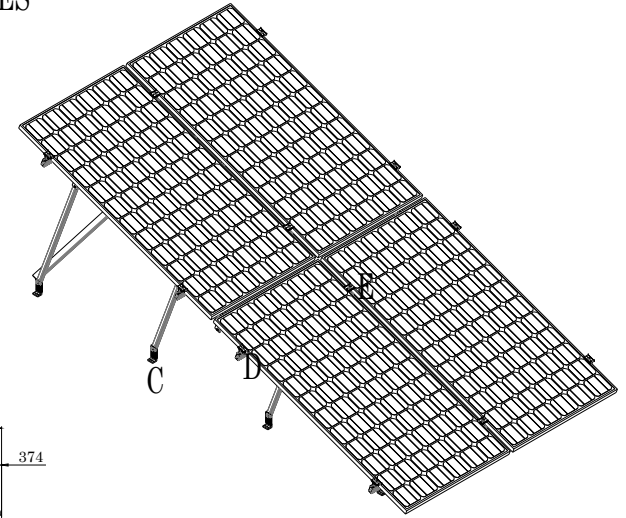

VISTA LATERAL

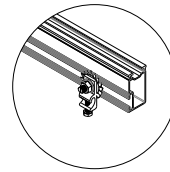
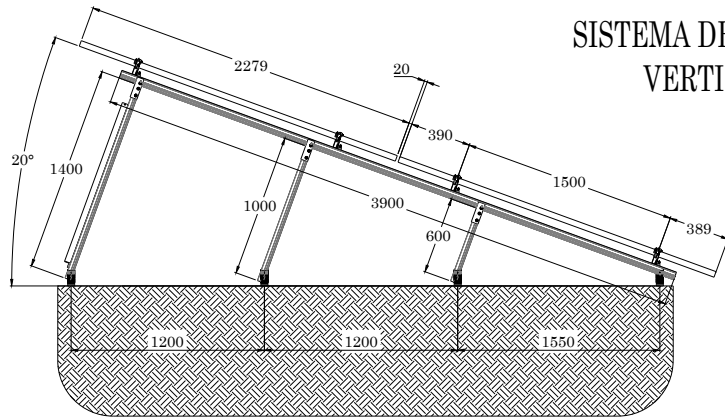
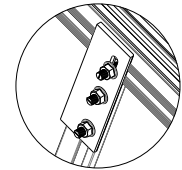
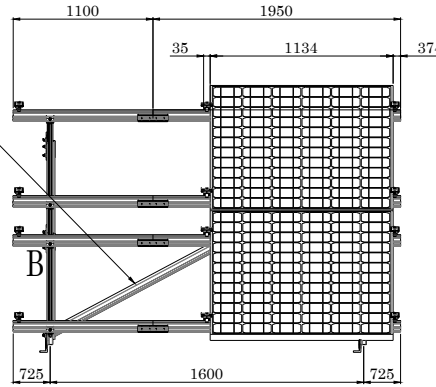

Conector Ángulo  
Riel

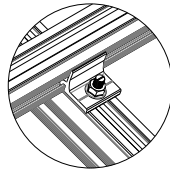

Clip de Conexión  
Next-Rail

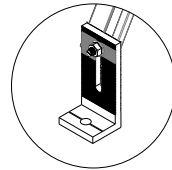

Soporte "L"

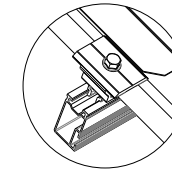

Abrazadera  
Universal  
(Modo Remate)

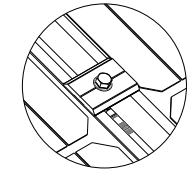

Abrazadera  
Universal  
(Modo Intermedio)

CORTES DE ANGULARES:

2 NXT-AR-2000: 1 tramo de 600mm  
+ 1 tramo de 1400mm en c/u

1 NXT-AR-2000: 2 tramos de 1000mm

CORTE DE RIELES:

2 NXT-R-2200-MILL: Se corta a la mitad c/u

2 NXT-R-3900-MILL: Se corta a la mitad c/u

# Parte	Descripción	Cantidad
NXT-R-2200-MILL	Perfil NextRail 2.2m, mill finish, Aluminio 6105-T6	2
NXT-R-3900-MILL	Perfil NextRail 3.9m, mill finish, Aluminio 6105-T6	4
NXT-R-4300-MILL	Perfil NextRail 4.3m, mill finish, Aluminio 6105-T6	0
NXT-SL-2	2 Soporte L de 105mm para Next-Rail	4
NXT-ER-2	2 Empalmes de riel con puesta a tierra, para Next-Rail	2
NXT-AU-30/50-2	2 Abrazadera universal p/panel con marco de 30-50mm	6
NXT-CNTR-4	4 Clips de conexión para Next-Rail	2
NXT-AR-2000	Ángulo-Riel 2.0m, mill finish, Alu 6105-T6	4
NXT-CAR-1	1 Conector de ángulo riel para Next-Rail	6
NXT-TCT-1	1 Terminal de conexión a tierra para Next-Rail	2
NXT-PCT-4	4 Placas de conexión final a tierra (panel-riel)	2
NXT-TB-M8x25-5	5 Tbolt M8x25 Acero Inoxidable con tuercas para Next-Rail	1
NXT-CLIP-5	5 Clips de plástico para dos cables, Next-Rail	2

observaciones:		 	
MATERIAL:			
FECHA:	19/07/2021	ESCALA: NA	HOJA 1 DE 1
ACOT:	mm [in]		
PESO:	30.42 kg		