



rise

Quick Start

01

Add plants to Nursery



02

Add plants to app



03

Move plant to your Garden

05

Grow your plants



06

Harvest your plants

04

Add Nutrients



07

Clean your Garden

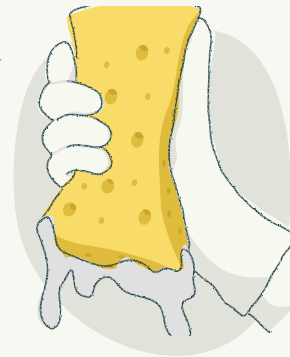



7 Steps Quick Start

7 important steps

01

Add plants to Nursery

Start by picking out which Plant Pods you wish to grow in your Garden. Place them in your Nursery.

NOTE: Pods started directly in your Garden will germinate more slowly.

02

Add plants to App

Every new plant should be added to the Nursery within your app. Once it grows for 2 weeks, move it into your Garden so that it contributes to your nutrient profile. The pods that you are not growing should be stored in a cool, dark place. The first time you use your Garden, you can place 4 plants in the Nursery and 4 straight into the Garden.

03

Move Plant to your Garden

These plants will sprout in 1-2 weeks and will be moved into your Garden when they have 2 sets of leaves.

04

Add Nutrients

You should start plants in Nursery before adding nutrients. Once your plants are about two weeks old, check your app to see if its time to add nutrients. Your app will tell you how much Sprout, Thrive, Blossom, and pH to add.

05

Grow your plants

Grow your plants to maturity! Each plant has a Plant Profile page that tells you how to care for that plant. Some plants will grow flowers that need to be pollinated, some need to be supported as they grow, and some just need time!

NOTE: As your plant grows it will shade other plants, so plan accordingly.

NOTE: If your plant stays in your Garden for too long, it may start to taste bitter or get too big for its neighbors and must be removed.

06

Harvest your plants

Check your app to see when your plant is ready for harvest! Some plants can be harvested many times, so be sure to check the plant's profile for tips on Harvesting.

07

Clean your Garden

After every harvest be sure to remove the plant (roots and all) and clean the Tray and Net Cup. After 3 months of growing it is time to deep clean.

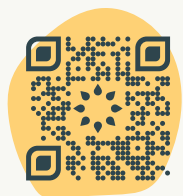

Scan here to learn more.

Step 01

Add plants to Nursery

a. Choose your pods

Select your preferred seed pods from your latest Rise Gardens' purchase.

NOTE: We do not use any adhesives on our seeds, so be sure to keep your pods upright so the seeds do not fall out from the pod!

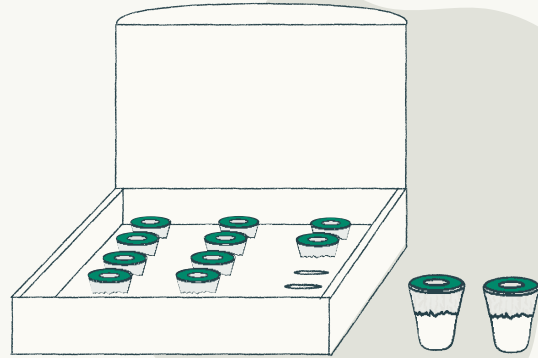

b. Poke hole

Using your finger or a sharp object, make a small hole in the top of your doughnut sticker.

Careful! Don't tip over!

Once you poked the hole, make sure you do not tip over your pods as the seeds can fall out.

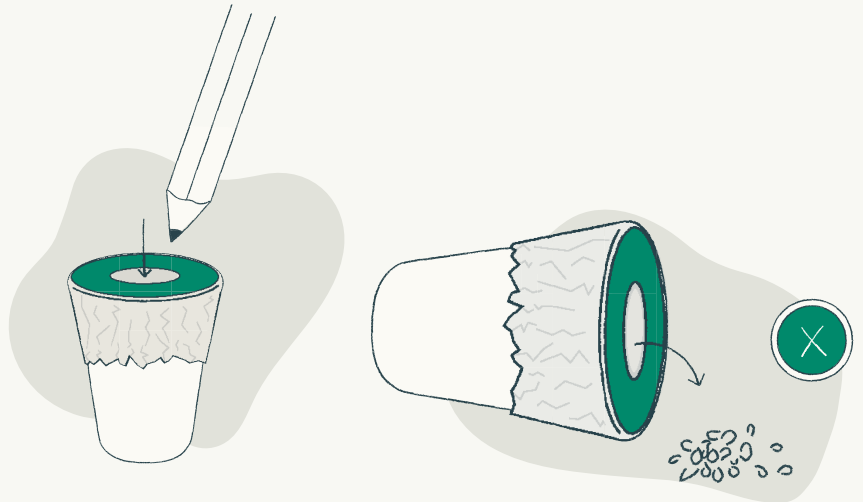

c. Place into Net Cup

Add the pods directly into the Net Cup. Be sure to grab the pod from both sides and keep it stable when lowering into the Net Cup.

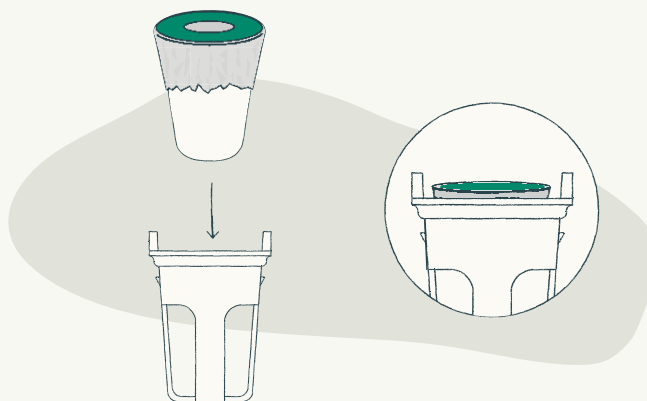

d. Ready for Nursery

You can now transfer them to your Nursery. One by one, place them into your Nursery. Make sure you feel or hear the tabs click into place. Cover with the humidity dome.

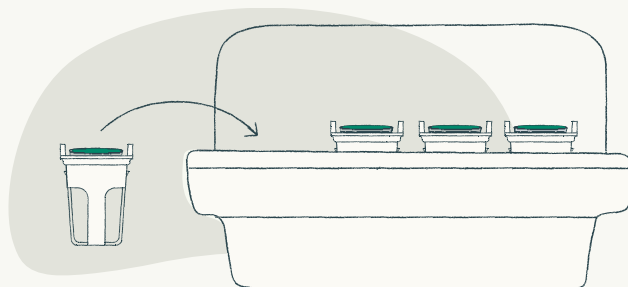

All set!

Place your Nursery under your Gardens grow lights and watch your plants germinate. Remember to change out your water every 7 days.

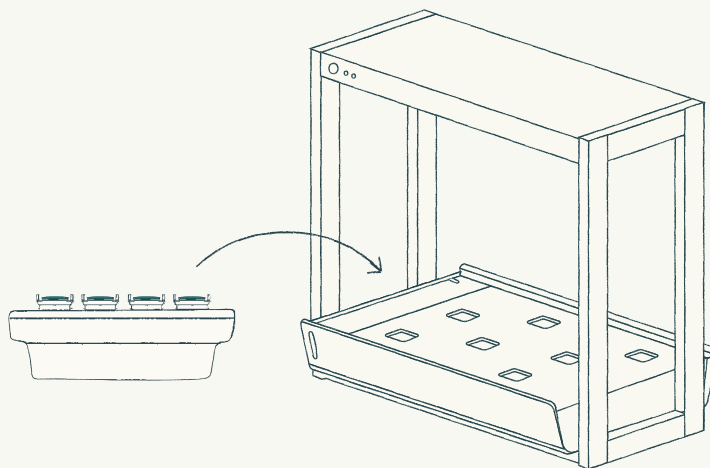

Once you've added seed pods to your Nursery, you should enter this information into the Rise Gardens App.

Step 02

Add to App

App guides you every step of the way and reminds you when to add water and nutrients. It's a personal professional gardener in your pocket.

Download Rise Gardens App

After you've assembled your new Garden, be sure to download the Rise Gardens App on an Apple or an Android device.



Download on App Store



Download on Google Play Store



Connect your Garden

Follow along with our WiFi Connection Guide to get your Garden online. We've made the set-up process easy in our Rise Gardens app.

risegardens.com/personal-garden-help

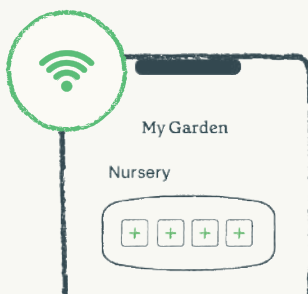

Solid green light in your Garden means you're online! Great job!

Choose your seeds

Choose which seeds you'd like to start growing in your Garden first. You'll have received one of our Rise Gardens Nurseries, so you can start germinating 4 seed pods at a time.

Remember: If you'd like more Nurseries, you can always purchase a 2-pack from our website.
risegardens.com

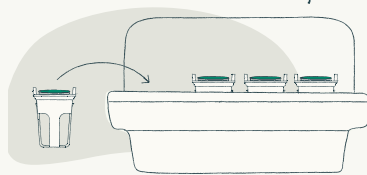

NOTE: Make sure that you add plants to your Nursery, not the Garden trays!

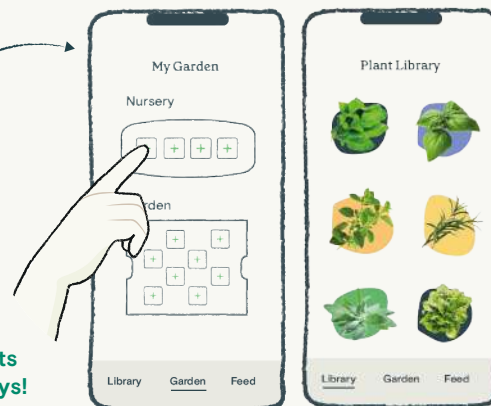

Why should I connect my Garden to WiFi?

By connecting your Garden to the internet, your Garden turns into a smart device. Your Garden will function just fine without being connected to the internet. But being connected to the internet offers these benefits:

- ◆ Get live information about your plants and your Garden's water level.
- ◆ Set your own light schedule for the LED Grow Lights in your Garden.
- ◆ Turn the Pump on and off in the App.
- ◆ Care indicator light functions.
- ◆ Get live notifications about when it's time to run Care (ie. add Nutrients to your Garden).
- ◆ Perform Care for your plants.



Scan here to download the App and get help.

risegardens.com/personal-garden-help

Step 03

Move plant to your Garden

Once they've grown their second set of leaves (or they've grown so tall that they've hit the top of the Nursery Dome, whichever comes first), it's time to transplant them into your Rise Garden and start feeding them Nutrients!



Step 04

Add Nutrients

In order to grow the best plants possible, we use the most advanced professional hydroponic growing techniques. We are the only company offering a 3-part blend with an additional pH balancing solution.

How do I get nutrients?

A bottle of **Thrive**, **Sprout**, and **pH Balance** are included in each Starter Kit for new Gardens. After they've run out, remember to order more nutrients when needed. You can also sign up for our **Nutrient Subscription Service** to make sure you're always stocked!



How do I add nutrients to the Garden?

Our proprietary mobile app takes the guesswork out of growing plants successfully through notifications and support each step of the growing process.

Just open up the Nutrients' bottles and drop the content the App recommends you to mix with Gardens' water.

NOTE: You should add nutrients to your Garden when your water-level is low. Make sure that you add water to your Garden in between adding nutrients.

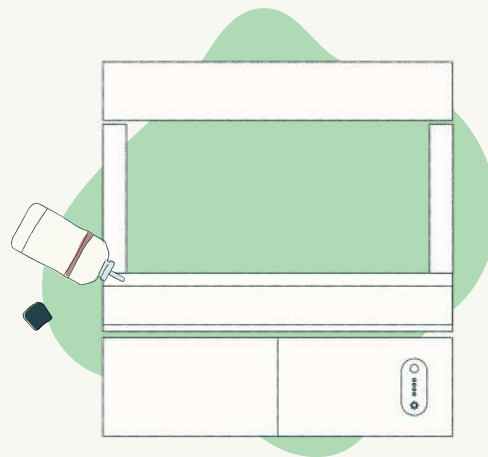

NOTE: If you add all of your nutrients at once, the nutrients could clump together and build up in the plumbing of your Garden over time.



Scan here to learn more about adding Nutrients.
risegardens.com/personal-garden-help



Sprout

Designed for early growth and helps fortify your plants leaves and stems.



Blossom

Created for late-stage growth and replaces your Sprout nutrient when your plants are ready to grow their flowers and fruits.

NOTE: Because you only need Blossom if you are growing flowering and fruiting plants, it is not included in your starter kit.

You can purchase our Blossom nutrient on our website: risegardens.com/products/blossom-plant-nutrient-mix



Thrive

Curated for your plants' entire growth cycle, this vital nutrient includes all of the micronutrients your plants need to grow and thrive.



pH Balance

Helps keep your pH in the targeted range of 5.8 and allows your plants to uptake their nutrients. You may need to add more or less depending on your tap water.

When adding new water to your Garden, you should always balance the pH of the water **BEFORE** it is introduced to your Garden.

NOTE: Because your nutrients are concentrated they must be mixed with water in order to properly dissolve. To do this, ALLOW FOR 5 MINUTES OF MIXING TIME in between each nutrient.



Step 05

Grow your plants

As your plant grows, it will transition through stages of growth.

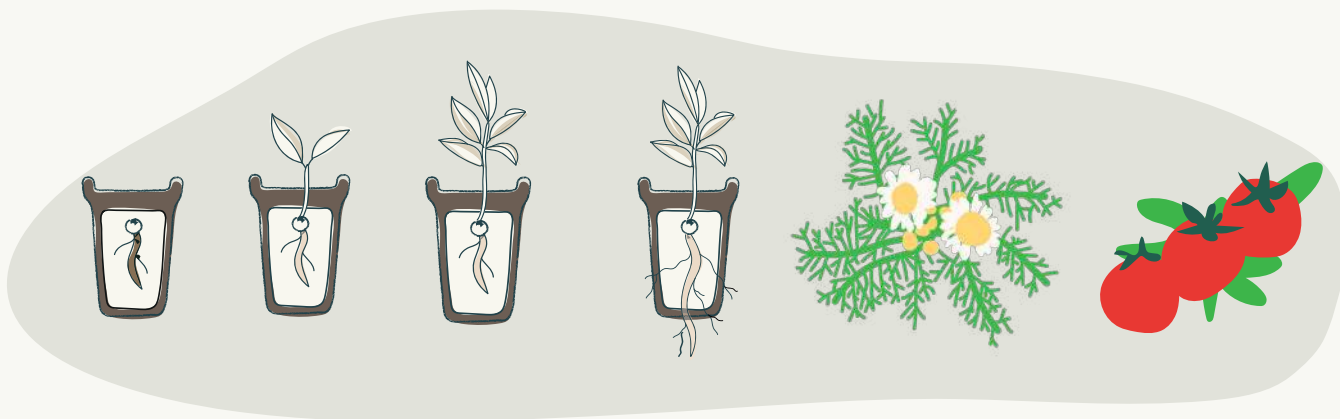

a. Germination

Your plant will sprout out of the pod. The length of this stage varies greatly from plant to plant. Most herbs take 1-2 weeks but lettuce should only take 3-5 days.

b. Initial growth

This stage marks when the plant has grown its second set of leaves and is ready to be moved into the Garden.

c. Mid-growth

This marks the plant's half-way point and is mainly used to mark an increase in nutrient need.

d. Flower

This stage occurs for every plant, but most plants should be eaten before they reach the Flower stage. For example, if your basil produces flowers it is past Harvest and ready to be removed. During the Flower stage, you should switch from using Sprout to using Blossom.

e. Fruit

This stage marks when your first 3 fruits appear. It also marks an increase in nutrients.

f. Harvest

This stage is when you can eat the plant. In plants like lettuce, this means the leaves have reached sufficient size. In plants like tomato, the fruit is ripe and is a uniform color.

g. Past harvest

This stage marks when the plant should be removed from the Garden because it is past its best flavor, or because it is too large and may shade other plants or grow roots that are too large.



Step 06

Harvest time

How do I tell if greens are ready to harvest?

If your lettuce plant has 10-15 leaves that look full and healthy, you can begin to harvest up to 20% of your plant at a time, or you can wait until your app says it's time to harvest and cut the whole plant at once.

If your kale or Swiss chard has 5-10 leaves that are full and healthy, you can cut the leaves at the base of their stem, starting with the bottom leaves.

How do I tell if herbs are ready to harvest?

All herbs will be ready to harvest when they have at least 3 stems and are around 6" tall.

How do I tell if fruiting plants are ready to harvest?

There will be at least 5 sets of flowers and your fruit will be the same color on top as on bottom. When you harvest your plants make sure that you leave enough of the plant remaining to keep it growing.

NOTE: Check your app for plant details as some plants are cut and come again.



Scan here to learn more about harvesting.

risegardens.com/personal-garden-help





Step 07

The 4 Rs of post harvest

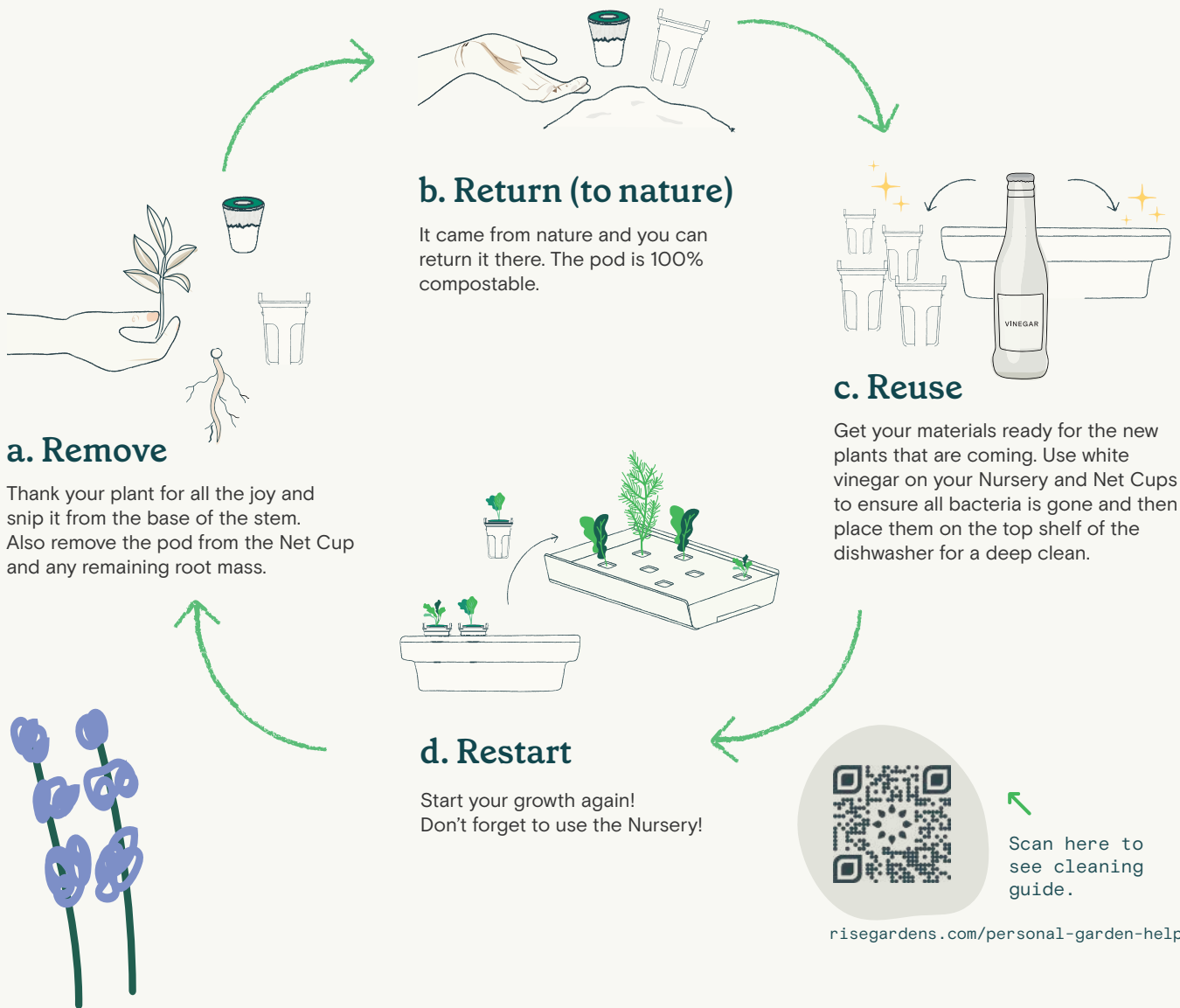



Need help?

Scan here and you'll find all the help you need to start gardening!



Our support team is here for you!

risegardens.com/personal-garden-help





risegardens.com