

5MP TVI, All-in-One HD CAMERA

C-TVI-BL5242-W



- 1/2.9" SONY 6MP CMOS sensor
- TVI 5M/AHD 5M/ CVI 4M/CVBS
- With IR-CUT, DNR, UTC, OSD
- Video Output: TVI/AHD/CVI/CVBS

WARRANTY

		Warranty Period: 2 years	
Product	BULLET CAMERA	Model	C-TVI-BL5242-W
Purchase		Serial No.	
Address		Customer	
Dealer		Representative	

▶ Please contact purchasing office or service center when you find any damage or problem with this product.

▶ The warranty period is 2 years from Invoice date.

◆A/S without cost◆

	Within Warranty Period	Warranty details	
		Within warranty	After Warranty
When damages occurred in normal working environment	Repair or Replace	Product	
		A/S without cost	
		Product exchange	

◆A/S with cost◆

	Damage by customer's negligence	Warranty details
chargeable case even within warranty	1. Damage by customer's careless handling 2. Damage by natural disaster (Fire, Flood, etc.) 3. Damage by not keeping the cautions and instructions on manual 4. Damage by not using appointed power(frequency, voltage) or adapter. 5. Damage by disassemble or cleaning by customer 6. Damage by repairment by a person excepting the dealer	A/S with cost

SPECIFICATION

DESCRIPTION	PAL
Imaging Device	1/2.9" SONY 6MP CMOS sensor
Effective Pixels	5MP (2592x1944)
Scanning System	Progressive Scan
Synchronization	Internal, Negative Sync
Horizontal Resolution	TVI 5M/AHD 5M/ CVI 4M/CVBS
Video Output	TVI 5M/AHD 5M/ CVI 4M/CVBS
S/N Ratio	More than 50dB (AGC Off)
Min. Illumination	0.001Lux(Color)/F1.2
IRIS Adjustment	Auto
LENS	2.8~12 Manual Zoom Lens
Electronic Shutter	Auto/FLK/1/25,30sec ~ 1/60000sec MANUAL(X2~X512)
IR LEDs	4PCS 42μ LEDs
Gama Characteristic	0.45
IR Distance	60 Meters
IR Status	Under 10 Lux by PD
Auto Gain Control	Auto
Day&Night	Auto
Privacy Masking	On / Off (Programmable)
3D-DNR	LEVEL(0~100)Adjustment
Digital Zoom	1.0X-8.0X
SENS-UP	OFF/ X2-X8
MOTION	ON/OFF
Digital Effect	OFF / V-FLIP / MIRROR / ROTATE
Dimension (mm)	218(W) x 90(H) x 90(D)mm
Weight(g)	1400
Input Voltage	DC 12V(±10%)
Power Consumption	IR OFF : 210mA / IR ON : 1000mA(±10%)
Operating Temp./Hum.	-10°C~ +50°C / 30% ~ 80% RH
Storage Temp. / Hum.	-20°C ~ +60°C / 20% ~ 90% RH

DIMENSION

C-TVI-BL5242-W

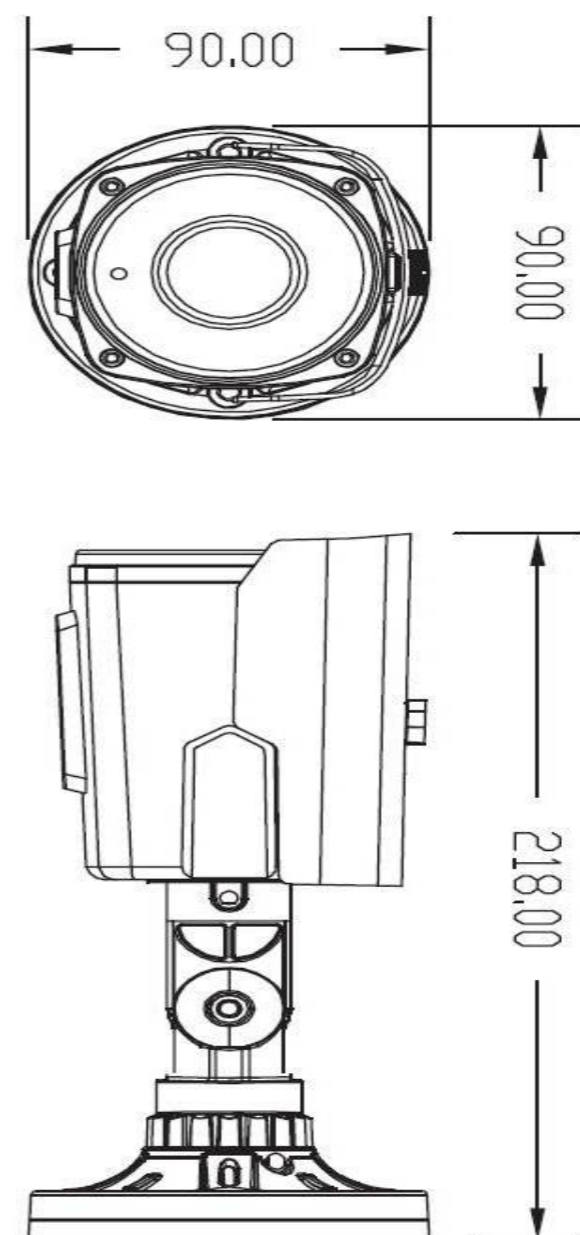

CONNECTING OF CAMERA

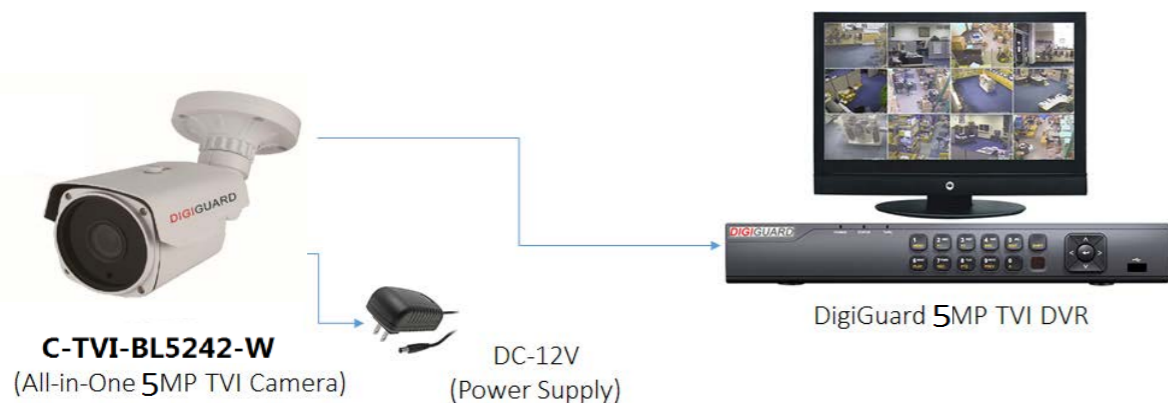

1. No Picture after providing power. May be the power supply voltage abnormality, please check the power supply voltage and pole whether exactitude. Please check all the connecting cable and monitors whether be connected correctly or not. ↓

2. The picture level direction have flowing interference ripples. May be caused by the power supply AC ripples, it need filter the wave of the power supply. Check the monitor and peripheral equipments used.

3. The picture background color changes continuously. The fluorescent lamp's electromagnetic field cause color roll. This is proper phenomenon of the cameras. Reduce the fluore scent lamp numbers or increase the distance between the camera and the fluorescent lamps can improve it. Use power supply external sync. camera can solve it.

4. The picture smear too mass . The power supply's voltage unstable. Connecting cables not connect correctly or have high impedance.

CAUTION IN INSTALLATION

- ♣ Do not install the camera opposite of the sun so that it be avoided direct light.
- ♣ Be careful not to drop this camera and not to impact on it. CCTV camera is a precision device.
- ♣ Do not pull the cable. If you pull the cable, it will make electrical problems such as disconnection.
- ♣ The camera should be worked within a range of the allowable temperature that refers to specification.
- ♣ Do not try to fix even if the camera does not work.
- ♣ Installation this camera at safety place where is no water, If the camera has some problems with water accidently. You have to contact A/S centre that sold the camera to you.
- ♣ If you would like to relocate the already installed product, be sure to turn off the power and then move or reinstall it.
- ♣ Please contact the nearest A/S centre if you find out any Problems. Please do not ignore any small problems they can become a big problem.

Feature Summary

* Sensor (CMOS)

1 / 2.9" SONY 6MP CMOS sensor

* Auto Gain Control (AGC)

Built-in auto gain control (AGC) circuit. The color camera can get high definition picture in low Lux condition.

* Scanning Mode

NTSC or PAL mode.

* Auto Electronic Shutter (AES)

Built-in auto electronic shutter function.

The color camera's AES speed can reach 1 / 100,000s.

* Gama Characteristic

Camera Gama characteristic is 0.45.

* Switch the output signal by OSD button

Press "left" key after 5 seconds then release : CVBS

Press "right" key after 5 seconds then release : TVI

Press "up" key after 5 seconds then release : AHD

Press "down" key after 5 seconds then release : CVI

CAUTION

 To prevent fire or shock hazarded. Do not expose the unit rain to rain or moisture.

 The symbol is intended to alert the user to the presence of important important operating and maintenance (servicing) Instructions in the literature accompanying the appliance.

 The symbol is intended to alert the user to the presence of uninsulated 'dangerous voltage' within the product's enclosure that may be of sufficient Magnitude to constitute a risk of electric shock to persons.

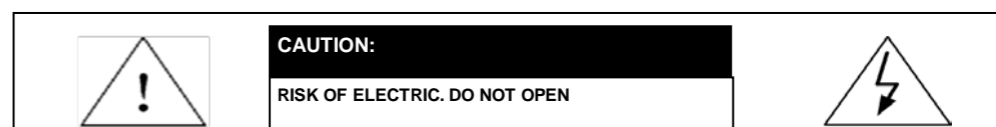

CAUTION: TO REDUCE THE RISK OF ELECTRIC SHOCK, DO NOT REMOVE COVER OR BACK NO USER SERVICEABLE PARTS INSIDE. REFER SERVICING TO OUALIFIED

CAUTION: To prevent electric shocks and risk of fire hazards, do NOT use other than specified power source.

 **Note:**

- Please note the camera's operating temperature and its using environment requirement. Avoid using the camera at too high or too low temperatures. The operating temperature is -30~+60°C. (Recommendatory operating temperature is -10~+50°C.)
- Never make the camera face the sun or bright object. Otherwise, it will damage the CMOS.
- Do not mount the camera near by the radiator or heater.