

# TAKEX PASSIVE INFRARED SENSOR

## PVW-12TE

### Instruction Manual

We appreciate your purchase of a TAKEX passive infrared sensor. This sensor will provide long and dependable service when properly installed. Please read this Instruction Manual carefully for correct and effective use.

**Please Note :** This sensor is designed to detect intrusion and to initiate an alarm ; it is not a burglary-preventing device.

TAKEX is not responsible for damage, injury or losses caused by accident, theft, Acts of God (including inductive surge by lightning), abuse, misuse, abnormal usage, faulty installation or improper maintenance.

## PRODUCT DESCRIPTION

PVW-12TE is a passive infrared sensor which detects infrared energy emitted by a human body and sounds the alarming messages through its built-in speaker. (Suitable for indoor/outdoor)

- 1) This unit can record two different messages and sound one of the messages according to the day light settings or external control input settings.
- 2) This unit is equipped with an "AND" detection and pulse count system.
- 3) The AND detection system will issue an alarm signal only when detection occurs in both horizontal and downward zones simultaneously.
- 4) This unit can be combined with other audible or visual warning devices to display and record the presence of visitors or intruders.

## 1 PARTS DESCRIPTION

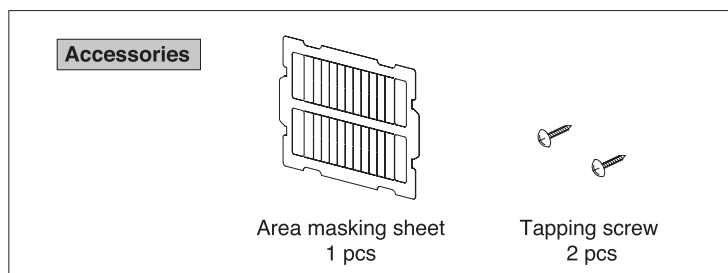
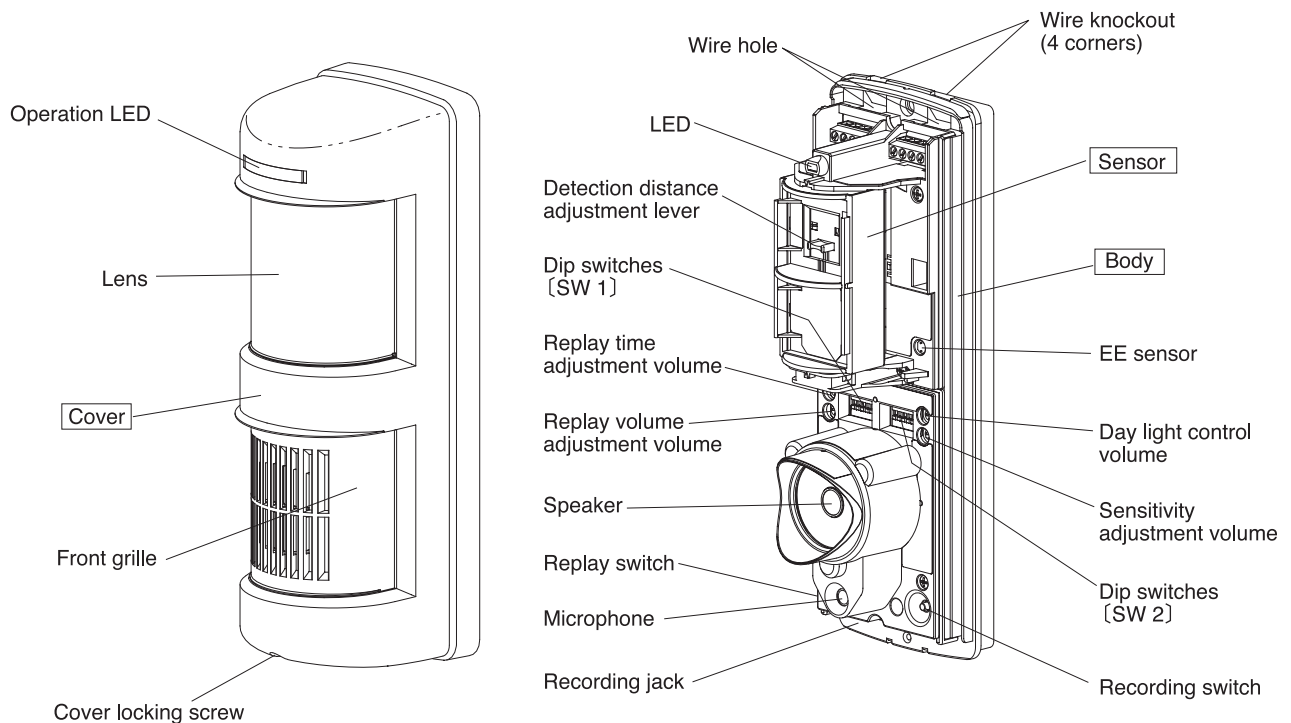

# 2 PRECAUTIONS

## 1. Precautions on installation

\* Install the unit at the height of 2.6' to 4.0' from the ground.

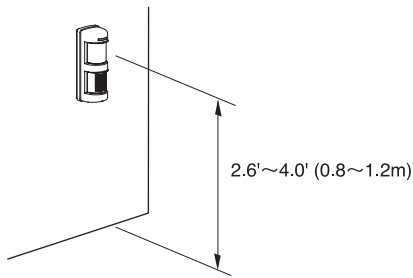

\* Install the unit vertically so that its horizontal zone is parallel to the ground.

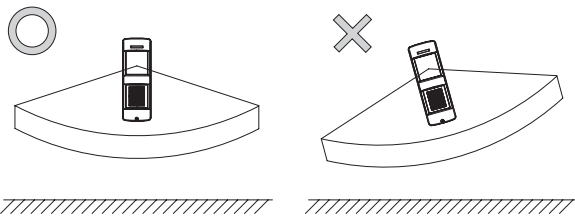

\* Install the unit in such a direction that people are more likely to cross the detection zone.

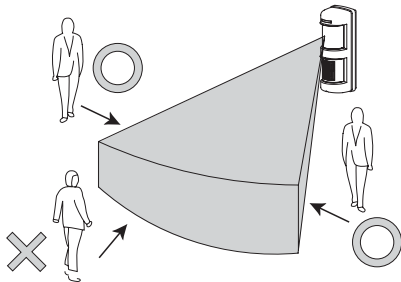

\* Do not install in an environment subject to electrical noise or intense vibration.

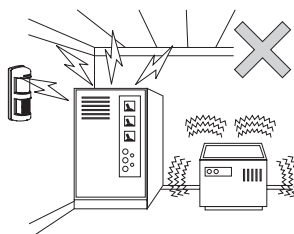

\* Do not install the unit by an air conditioning exhaust vent.

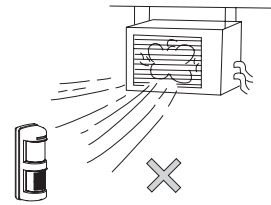

\* Remove all obstructions (trees, clotheslines, etc.).

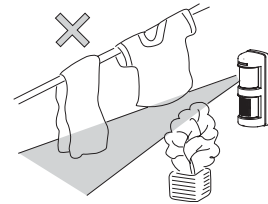

\* Remove all obstacles (including clear glass) which will create non detection zone.

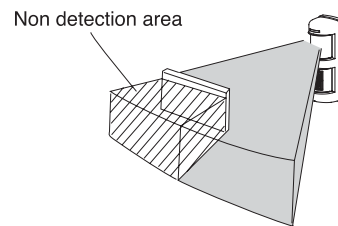

\* Make sure that downward zone will not be affected by sun light reflected by water on the road etc.

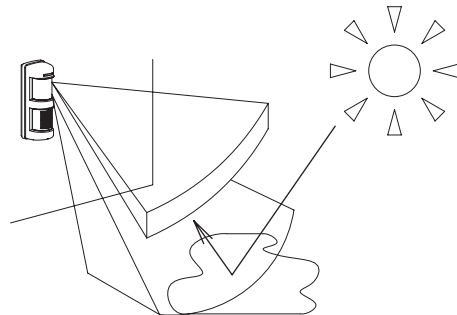

◎ Make sure that there is no undesirable detection of traffic including vehicles if there is a path or road at the front of detection zone.

## 2. Other Precautions

- The unit takes about 1 min to warm up after power is supplied.
- The unit is equipped with day light switch. When DAY is selected, the unit issues an alarm signal only when its surrounding area is brighter than set illuminance. When NIGHT is selected, the unit issues an alarm signal only when its surrounding area is darker than set illuminance.
- The unit outputs sounds repeatedly during detection time + delay time set by a potentiometer.

- Do not pour water directly on this unit as it is designed to be rainproof not waterproof.
- Do not insert small objects such as screw drivers into the slit of the front grille since it could damage inside filter and cause malfunction.
- When the unit is soiled, clean the cover with a soft cloth moistened with a small amount of cleansing-solution. Do not use chemicals such as thinners or alcohol.

# 3 DETECTION AREA

The detection area of this unit consists of horizontal zone and downward zone. The unit initiates an alarm signal only when detection occurs in both horizontal and downward zones simultaneously. By adjusting the angle of the downward zone, detection distance can be set.

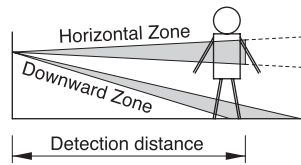

The unit initiates an alarm signal only when detection occurs in both horizontal and downward zones simultaneously.

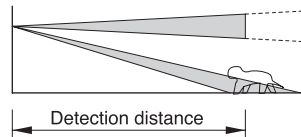

The unit doesn't detect small objects such as small animals which are unlikely to reach the height of horizontal zone.

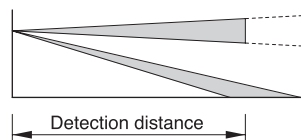

The unit doesn't detect objects which are away from the downward zone like automobiles.

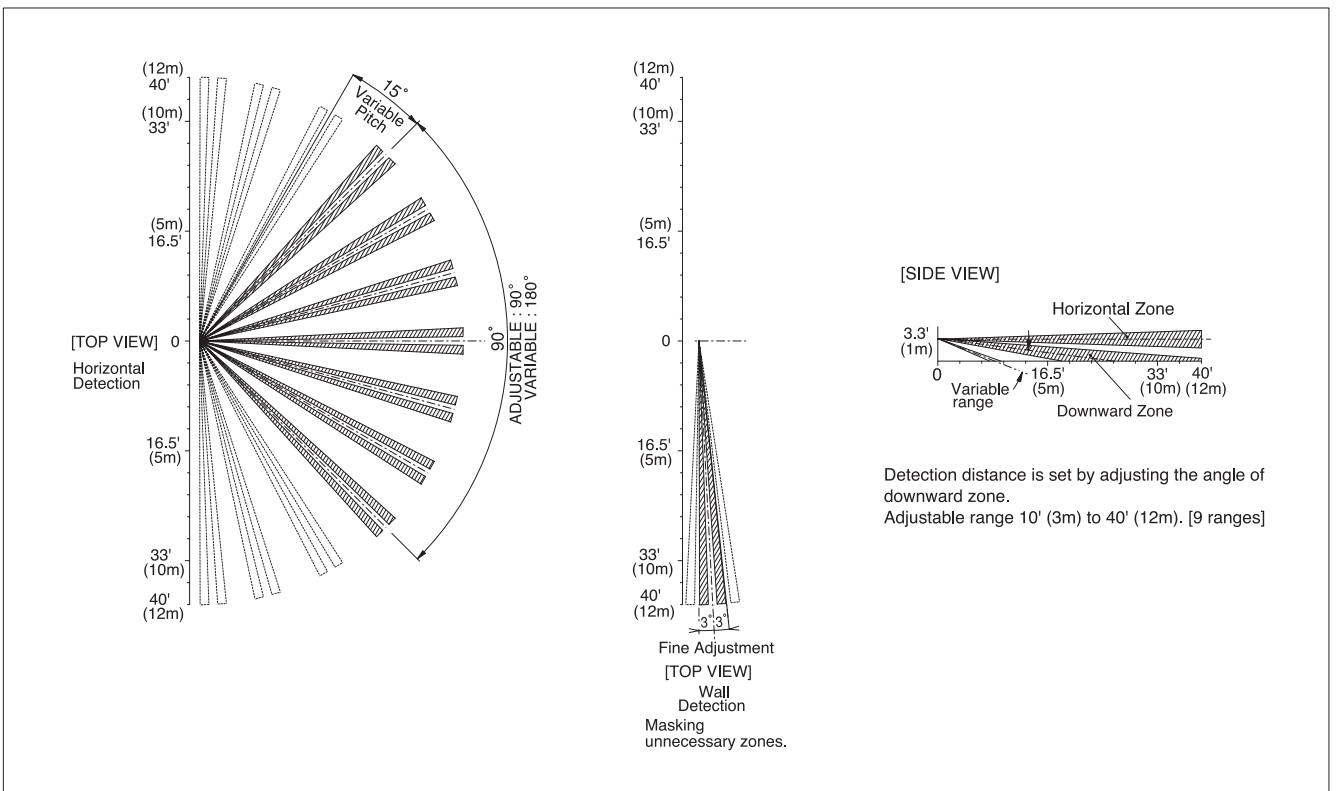

Detection distance is set by adjusting the angle of downward zone. Adjustable range 10' (3m) to 40' (12m). [9 ranges]

## Area adjustment

[Wide angle detection]

The sensor can be rotated up to  $\pm 90^\circ$  horizontally. (15 pitches)

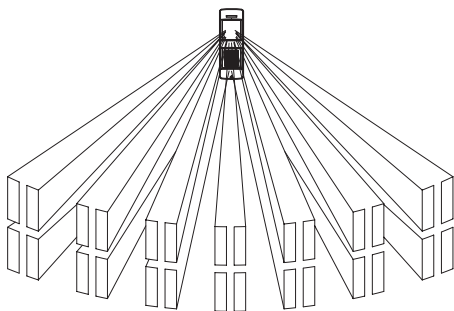

- (1) Install the sensor so that it faces to the center of the area to be detected. When the unit is rotated more than 45 degrees, the number of detection zones are reduced.

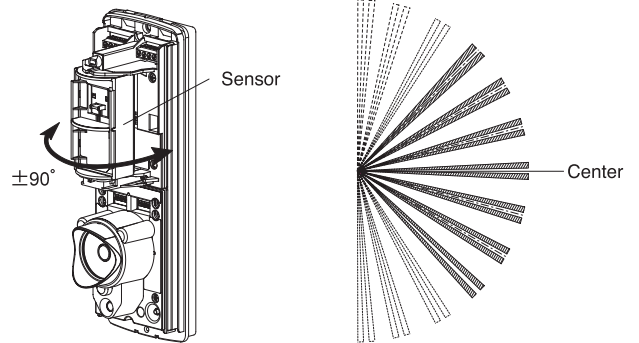

- (2) Detection area consists of seven detection zones. (Wide angle:  $90^\circ$ )

- (3) Area masking sheet is available for removing detection zones.

**[Wall detection]**

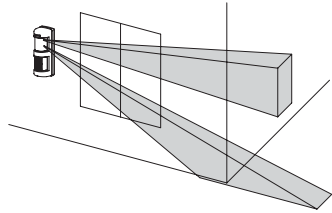

- (1) Attach area masking sheet to the lens holder (inside the cover) without cutting it out.  
(Refer to Area masking on how to attach the sheet to the lens holder.)
- (2) Rotate the sensor by 90° and face it to the direction to be detected.
- (3) Horizontal fine adjustment  
Fine adjustment can be made within the range of ±3°, in case there is some obstacles on the wall.  
(Detection zone shifts about 2' (0.6m) at 40' (12m) range.)  
Slide the lever to the left or right.  
\*Make sure that the lever be set at 0° for horizontal detection.

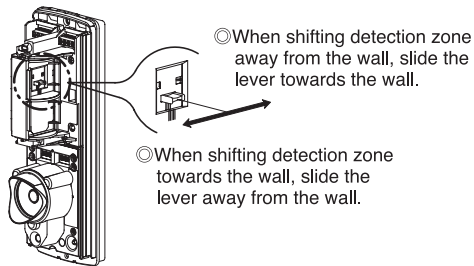

**○Detection distance adjustment**

Detection distance can be adjusted within a range from 10' (3m) to 40' (12m) by changing the angle of downward zone vertically. Refer to the index and slide the adjustment lever up or down. Slide it up and the detection distance becomes shorter and slide it down and the detection distance becomes longer.

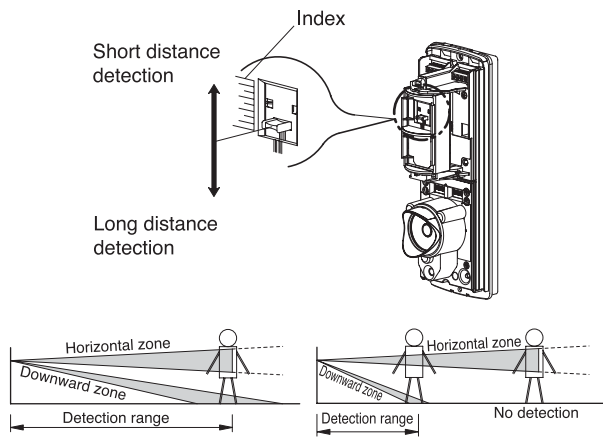

**IMPORTANT NOTES**

The following factors may have an effect on the actual detection range or sensitivity. The greater the distance covered, the more prominent this effect becomes.

- Ambient temperature vs object temperature.  
Actual detection range may decrease when the object being detected of similar temperature to the ambient target area.
- Direction of object path.  
PIR detection works best when movement crosses the sensitive zones. Sensitivity deteriorates when movement is directly towards the detector within single zones.
- Mounting height.  
The closer the mounting height is to the ground, the shorter the achievable detection range.
- Mounting orientation.  
Detector should be installed on a true vertical to ensure proper detection range.
- Slope in detection area  
When the ground slopes downward (upward) from the sensor, the detection range becomes longer (shorter).

The following settings should be appropriately adjusted by WALK TEST in order to obtain expected performance of the detector according to the various environmental factors of the installation site.

- Detection range adjustment.  
(Adjustment lever with 9 steps)  
The distance index is not definitive and is only to be used as a guide.
- Area setting.  
Consider likely object travel direction to maximise possibility of crossing sensitive zones.
- Sensitivity setting (by PIR SENS pot).

Detection area when there is a little temperature difference. (ex. hot summer)

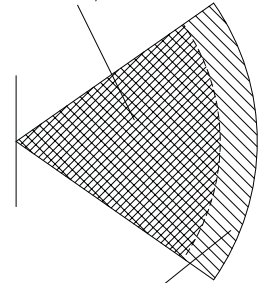

Detection area when there is a big temperature difference. (ex. cold winter)

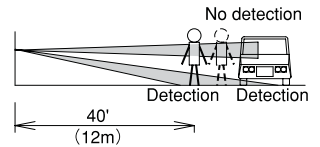

Note that the actual detection range may lessen by up to 20% when the ambient temperature is enough high so that there is a little temperature difference the object to be detected and the background. (See below figure) If this situation is likely then it is recommended to increase the detection range to compensate.

- When there is a path or road at the front of detection zone, vehicles with comparatively higher temperature than human body may be detected at a longer distance. Readjust the area setting and range adjustment when there is such undesirable detections.

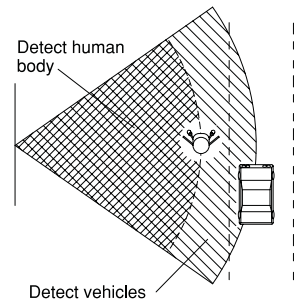

**○Area masking sheet**

Unnecessary zone can be masked with the area masking sheet.

- (1) Cut out the necessary zone numbers on the area masking sheet.  
Make sure that the same zone numbers of both horizontal and vertical zones on the area masking sheet are cut out.
- (2) Attach the area masking sheet to the lens holder located inside cover.

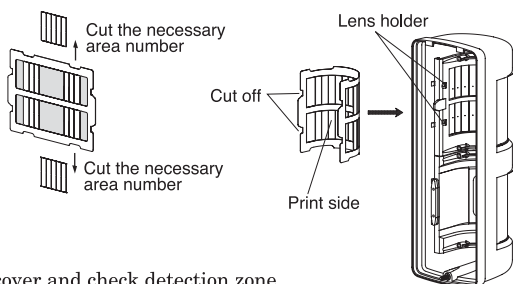

- (3) Attach cover and check detection zone.

\*Zone ⑦ is unable to be masked with the sheet.

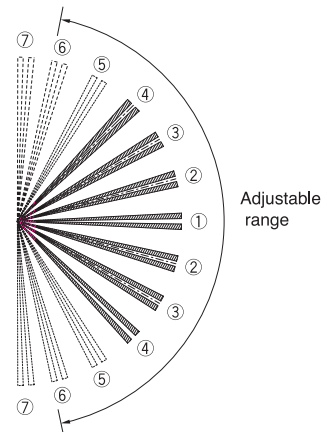

# 4 ADJUSTMENT

## (1) Operational outline

### ◎ Contact output (one shot, approximately 2 sec.)

Arm/Disarm control: Armed or Disarmed is set by the external input.  
When set at Armed, the unit outputs a contact output.  
When set at Disarmed, the unit does not output.

Day light control: The built-in sensor distinguishes Day from Night.  
When recognized as Night, the unit outputs a contact output.  
When recognized as Day, the unit does not output.

### ◎ Sound output (activated during detection time plus delay timer: 2 sec to 5 min)

Arm/Disarm control: Armed or Disarmed is set by the external input.  
When set at Armed, the unit outputs the message recorded in the [Message 1].  
When set at Disarmed, the unit outputs the message recorded in the [Message 2].

Day light control: The built-in sensor distinguished Day from Night.  
When recognized as Night, the unit outputs the message recorded in the [Message 1].  
When recognized as Day, the unit outputs the message recorded in the [Message 2].

Replay input control: Replay input (N.O. or N.C. selectable) can trigger the messages.

[Operational flow chart]

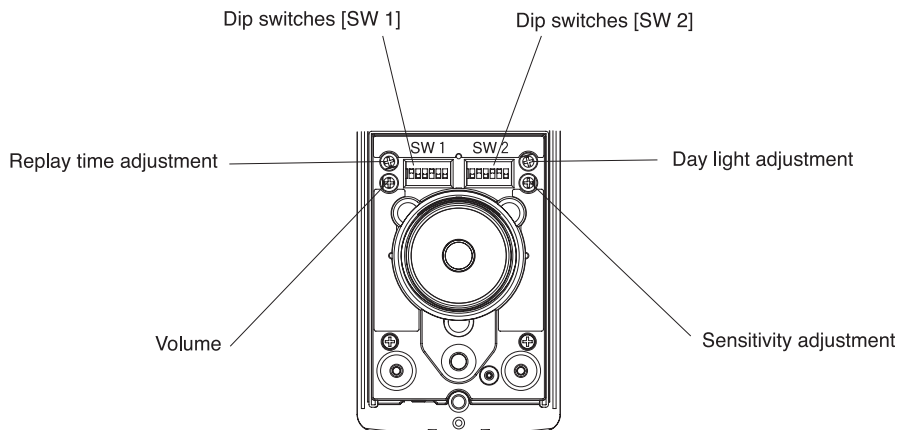
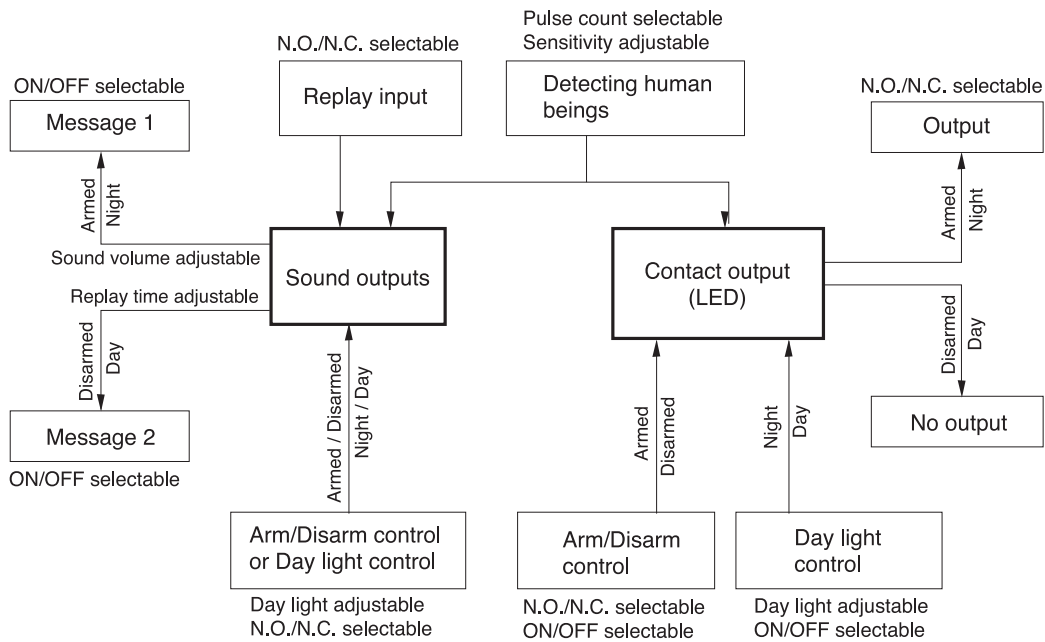



## (2) Functional adjustment



### ◎ Warm-up period

Operation LED blinks for about 1 min. after supplying power.  
The unit does not operate for this time as it is the sensor stabilizing period.



### ◎ LED ON/OFF selectable switch [SW1] - 1

	ON [Factory set]	Blinks for warm-up. Light at alarm. Fast blinks for standby for recording. Light for recording.
	OFF	LED disabled except the below situation. Fast blinks for standby for recording. Light for recording



### ◎ Contact output selectable switch [SW1] - 2

	N.O.
	N.C. [Factory set]



### ◎ Pulse count selectable switch [SW1] - 3

	Three times	Less sensitive, prevents false alarms caused by temperature fluctuation.
	Once [Factory set]	More sensitive Detects small movements such as the movements of human beings



### ◎ Message control selectable switch [SW1] - 4

	Arm / Disarm [Factory set]	Armed: Message 1 / Disarmed: Message 2
	Day light control	Night: Message 1 / Day: Message 2



### ◎ Output control selectable switch (Arm/Disarm) [SW1] - 5

	ON	The unit issues contact output only when set at Armed. When set at Disarmed, no signal is outputted.
	OFF [Factory set]	Alarm input control disabled.



### ◎ Output control selectable switch (Day/Night) [SW1] - 6

	ON	The unit issues contact output upon detection only during night time.
	OFF [Factory set]	The unit issues contact output both day and night.



### ◎ Arm/Disarm input selectable switch [SW2] - 1

	N.O.	When closed: Armed (When opened: Disarmed)
	N.C. [Factory set]	When opened: Armed (When closed: Disarmed)



### ◎ Replay input selectable switch [SW2] - 2

	N.O. [Factory set]	When closed: Replay
	N.C.	When opened: Replay



### ◎ Sound mode selectable switch [SW2] - 3

	Recording mode	Message is recorded. The unit does not make detection.
	Operational mode [Factory set]	The unit makes detection.

### ◎ [Message 1] selectable switch [SW2] - 4

	ON [Factory set]	[Message 1] selected.
	OFF	[Message 1] is not selected.

### ◎ [Message 2] selectable switch [SW2] - 5

	ON [Factory set]	[Message 2] selected.
	OFF	[Message 2] is not selected.



◎ Message control reference chart [SW1 - 4]

		Message 1 [SW2-4]	ON	ON	OFF	OFF
		Message 2 [SW2-5]	ON	OFF	ON	OFF
Message control selectable [SW1-4]	Arm/Disarm control	Armed	Message 1	Message 1		
		Disarmed	Message 2		Message 2	
	Day light control	Night	Message 1	Message 1		
		Day	Message 2		Message 2	

◎ Contact output control reference chart [SW1 - 5, SW1 - 6]

		Output control selectable switch [SW1 - 6]			
		SW1 - 6	ON		OFF
Output control selectable switch [SW1 - 5]	SW1 - 5	Status	Night	Day	—
		ON	Armed	Output	
	Disarmed				
	OFF	—	Output		Output

◎ Replay time adjustment (Sound output)

The unit repeats the message during the detection time + off delay time.

	Delay time can be adjusted between 2sec. and 5min. [Factory set: 2sec.]
--	---

\*The unit does not stop the message output even if the message is longer than the set time.

◎ Sound volume adjustment

	Sound volume can be adjusted between Min. (silence) and Max. [Factory set: Middle]
--	--

◎ Day light

	Recognized as night when the illuminance of the surrounding area is lower than 10 lux. [Factory set]
	Always recognized as night regardless of the illuminance of the surrounding area.

◎ Sensitivity adjustment

	Sensitivity can be adjusted between 30 % (L) and 170% (H). [Factory set: 100%]
--	--

[Factory set]

Audio output
* Output the [Message 1] for Armed and the [Message 2] for Disarmed.
<ul style="list-style-type: none"> <li>· Sound mode: Operation</li> <li>· Audio output control: Alarm control</li> <li>· Day light: Night</li> <li>· Replay time: Approx. 2sec.</li> <li>· Sound volume: Middle</li> <li>· Message 1: ON</li> <li>· Message 2: ON</li> </ul>

Contact output
<ul style="list-style-type: none"> <li>· Contact output: N.C.</li> <li>· Output control selectable switch (Arm/Disarm): OFF</li> <li>· Output control selectable switch (Day/Night): OFF</li> </ul>

Contact input
<ul style="list-style-type: none"> <li>· Arm/Disarm selectable switch: N.C.</li> <li>· Replay input selectable switch: N.O.</li> </ul>

Sensitivity
<ul style="list-style-type: none"> <li>· Pulse count: One</li> <li>· Sensitivity: Middle point</li> </ul>

# 5 RECORDING

Two separate messages can be recorded in the unit [Message 1] and [Message 2]. One of the messages is selected and issued according to the situation and setting of the equipment. Two recording methods are available, through built-in microphone or other external equipments such as tape recorders or personal computers.

- 1) Connect the recording jack of this unit and the external equipment with a plug.  
The recording system of this unit is monophonic.  
[When external equipment is used.]
- 2) Select either [Message 1] or [Message 2] for recording and turn it on. [SW2-4, 5].  
Ensure the other switch is off.
- 3) Select the recording mode on the sound mode selectable switch and the unit will be in a standby mode for recording and LED starts to blink fast. [SW2-3]
- 4) Press the RECORDING switch (Red) and the LED stops blinking and continues to light.  
(Message can be recorded as long as the LED lights with the RECORDING switch pressed. Max. 8sec.)
- 5) Record the Message through either external equipments or built-in microphone.
- 6) Press REPLAY switch (Black) for confirming the recorded sound.
- 7) Select the other sound switch and turn it on.  
Repeat the procedure from 2) to 6).
- 8) After recording is completed, check the recorded sounds as below.
  - ① Turn on both switches for [Message 1] [SW2-4] and [Message 2] [SW2-5].
  - ② Press REPLAY switch (black).  
The speaker replays [Message 1] first and then [Message 2].
- 9) After checking recorded message, select the operational mode on the sound mode selectable switch [SW2-3].  
When the recording mode is selected, the sensor does not make detection.

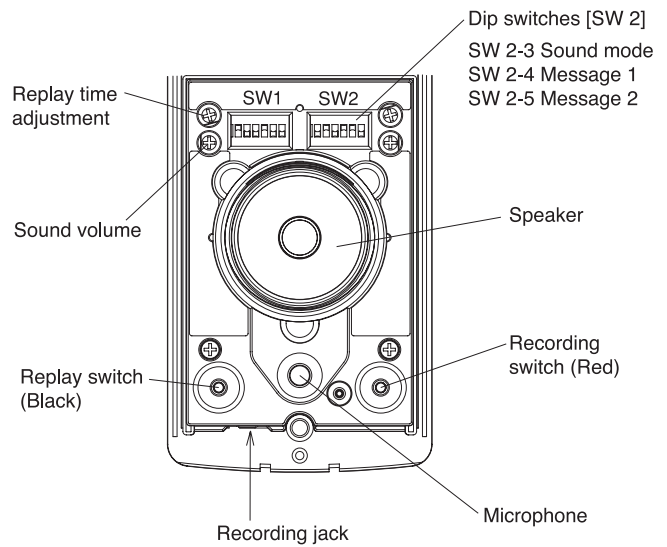

# 6 WIRING

## 1. Terminal Configuration

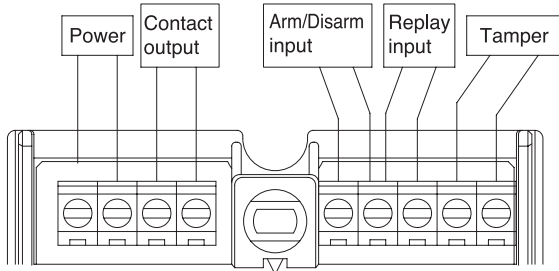

### SUPPLY VOLTAGE

- 10V to 30VDC (Non polarity)
- Power consumption  
55mA or less for standby  
300mA or less for detection (when set at max. volume)

### OUTPUT SIGNAL

- Dry contact relay output is N.O./N.C. selectable with a switch  
Operation: One shot operation approx. 2sec.  
Contact capacity: 30V (AC/DC), 0.5A MAX. (resistive load)  
Output control: [Armed / Disarmed input control]  
[Day light control]

### ARM/DISARM INPUT

- Dry contact relay output is N.O./N.C. selectable with a switch  
N.O.: When closed Armed  
N.C.: When opened Armed  
Response time: 300msec. or more  
Input resistance: 1k $\Omega$  or less

### REPLAY INPUT

- Dry contact relay output is N.O./N.C. selectable with a switch  
N.O.: When closed Replay  
N.C.: When opened Replay  
Response time: 300msec. or faster  
Input resistance: 1k $\Omega$  or less

### TAMPER

- Dry contact relay output N.C.  
Contact operation: Open when cover is detached  
Contact capacity: 30V (AC/DC), 0.5A MAX. (resistive load)

◎ WIRE SIZE: AWG24 (0.2mm<sup>2</sup>) to AWG14 (2mm<sup>2</sup>)



## 2. Wiring distance

Size of wire used	Power voltage	
	DC12V	DC24V
0.3mm <sup>2</sup> (φ0.65mm)	135' ( 40m)	795' (240m)
0.5mm <sup>2</sup> (φ0.8mm)	233' ( 70m)	1160' (350m)
0.8mm <sup>2</sup> (φ1.0mm)	363' (110m)	1815' (550m)
1.2mm <sup>2</sup> (φ1.25mm)	563' (170m)	2805' (850m)

NOTE : 1) Maximum wiring distance when two or more sets are connected is the value above divided by number of sets.

2) The signal line can be wired to a distance of up to 3,000ft. (1,000m) with AWG 22 (dia. 0.65mm) telephone wire.

## 3. Wiring insertion

### ○ Exposed wiring

- Break one outside knockout and its related inside knockout as necessary. Pull wire through the insertion holes and connect it to the terminals.

### ◎ Mounted wiring

- Break inside knockout, pull wire through wiring hole and connect it to the terminals.

\* When installing the sensor to flush mount box, use wall mount bracket (BW-24) [sold separately].

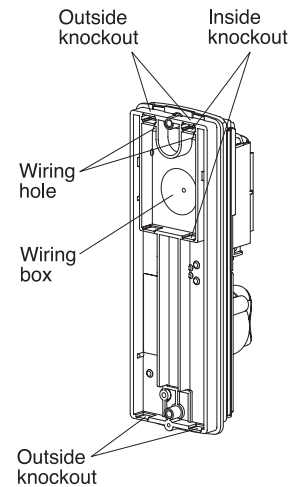

# 7 INSTALLATION

- (1) Refer to PRECAUTIONS (2) and install the sensor.
- (2) Loosen the cover locking screw and detach the cover.

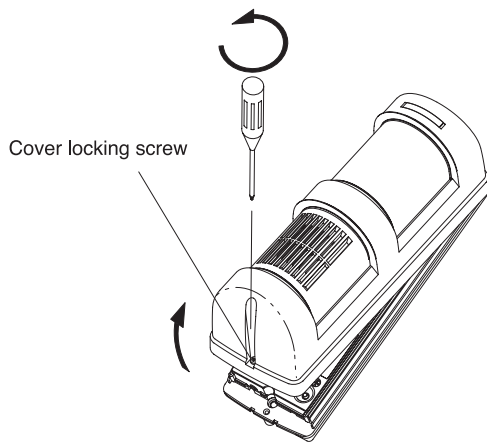

- (3) Refer to the WIRING (6) and connect wires to the terminals.
- (4) Install the unit.

- (5) Refer to DETECTION AREA (3) and OPERATION CHECK (8) and check detection area and check operation.
- (6) After confirming detection area and operation check, attach the cover and fix the cover locking screw.

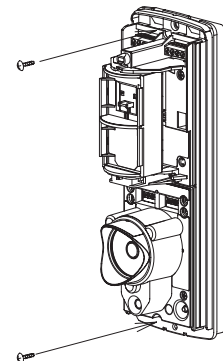

# 8 OPERATION CHECK

## 1. CONFIRMATION OF THE DETECTION AREA

- (1) Make the settings as below for checking detection area.
 

Sound mode: Operational mode	Contact output alarm control: OFF
LED : ON	Contact output day light control: OFF
Replay time: 2sec.	Sound control: Armed
- (2) Refer to the DETECTION AREA (3) and set the horizontal angle and detection distance.
- (3) Attach cover and fix the cover locking screws.
- (4) Supply power and wait for about 1min until the LED stops blinking.
- (5) Walk across the detection area and confirm its size and location through LED or sound.
- (6) Adjust detection distance, detection angle, sensitivity, masking, or pulse count if necessary.
- (7) Adjust the sound volume according to the purpose of use.

## 2. OPERATION CHECK

- (1) Make the final function settings according to the purpose of use. (Keep the operation LED ON.)
  - (2) Replay the Message 1 and 2 and confirm the recorded sounds.
  - (3) Attach the cover to the sensor and let the sensor make detection. Check the operation of the LED, sound or connected devices.
  - (4) Make the final setting on the operation LED and fix the cover with the cover locking screw.
- \* Make sure that there is no undesirable detection of traffic including vehicles if there is a path or road at the front of detection zone.

# 9 TROUBLESHOOTING

Solve possible problems according to the following table. If normal operation cannot be restored by these means, contact either the dealer from whom you bought the unit or

Trouble	Possible cause	Corrective Action
Completely inactive	No power supply, broken wire or improper voltage.	Correct power supply or replace broken wire.
	Cover shielded by substances (including glass).	Remove the substances.
	Improper area adjustment.	Readjust the protection area setting.
	Improper settings of the alarm control and day light control.	Reset the settings of the alarm control and day light control.
	Warming-up time (about 1min.) has not been finished yet.	Allow for warming-up time., (about 1min.)
	Recording mode is selected. (The LED blinks fast.)	Select the operational mode.
Sometimes inactive	Improper area adjustment.	Readjust the protection area setting.
	Improper settings of the alarm control and day light control.	Reset the settings of the alarm control and day light control.
	Cover face is soiled with dust or water drop.	Clean the cover with soft cloth.
Activated when no person has passed	Unstable power voltage.	Stabilize the power voltage.
	Something moving in protected area or too rapid temperature variations.	Remove the cause. Lower the sensitivity. Select Three times for pulse count.
	Large electrical noise source such as power machine nearby or its wiring close to that of sensor.	Relocate device.
	Intense reflection of sun light or head light shining on the sensor.	Relocate device. Readjust the protection area setting.
	Reflective lights such as sun light or head light affect the downward zone.	Remove reflective objects. Readjust the protection area setting.
	Improper installation of the sensor.	Install the sensor parallel.
	Detection distance of the downward zone is too long.	Readjust detection distance.
The alarm LED lights, but connected device is inactive	Poor contact connection or broken wire.	Check the wiring or connection.
	Contact output is not working.	Check the contact output terminal using a tester.
	Malfunction of the connected devices.	Check the connected devices.
	Recording mode is selected.	Select the Operational mode.
	Operational mode is selected. (Sound mode selectable switch)	Select the recording mode. (LED starts to blink fast.)
	Improper settings of the sound selectable switches.	Select either [Message 1] or [Message 2] for recording and turn it ON. Make sure that the other one is turned OFF.
Unable to record	Connected plug does not conform to the specification of the recording jack.	Use the plug which conforms to the specification of the recording jack.
	Replay volume, Min. (Silence) is selected.	Adjust the volume.
Unable to be replayed	Both sound selectable switches [Message 1] and [Message 2] are turned OFF.	Turn on one of the sound selectable switches [message 1] and [Message 2] for replaying.
	N/C (When opened : Replay) is selected when the replay input is not used.	Make sure that N/O (When closed : Replay) is selected when the replay input is not used.

# 10 SPECIFICATIONS

Product name	Passive Infrared Sensor (For indoor/outdoor use)
Model	PVW-12TE
Detection system	Passive infrared
Coverage	Horizontal coverage Max. detection distance: 40' (12m)    Horizontal detection zone: 7 zones Detection angle: 90°    Downward detection zone: 7 zones
Adjustment range	Horizontal: $\pm 90^\circ$ ( $\pm 3^\circ$ of fine adjustment is available) Detection distance: 10' to 40' (3 to 12m) (By adjusting vertical angle of downward curtain)
Supply voltage	10 to 30VDC (Non polarity)
Current consumption	55mA MAX. for standby 300mA MAX. for operation (When Max. volume)
ARM/DISARM input	<ul style="list-style-type: none"> <li>· N.O./N.C. selectable with a switch</li> <li>  N.O.: Armed when closed</li> <li>  N.C.: Armed when opened</li> <li>· Response time: 300msec or longer</li> <li>· Input resistance: 1k<math>\Omega</math> or less</li> </ul>
Replay input	<ul style="list-style-type: none"> <li>· N.O./N.C. selectable with a switch</li> <li>  N.O.: Armed when closed</li> <li>  N.C.: Armed when opened</li> <li>· Response time: 300msec or longer</li> <li>· Input resistance: 1k<math>\Omega</math> or less</li> </ul>
Day light control	Recognized as night when the illuminance of the surrounding area is lower than the set illuminance.
Contact output	Dry contact relay output N.O./N.C. selectable with a switch Contact capacity: 30V (AC/DC), 0.5A MAX. Contact operation: One shot operation Approx. 2sec.
Sound output	Replay the two different messages through the built-in speaker Operation: off delay operation Repeat sounds during detection time + Approx. 2sec. to 5min. Output sounds: [Message 1] and [Message 2] (Max. 8sec. each) Sound volume adjustment: 80dB Max. Recording method: Built-in microphone or Jack input
Operation LED	Red LED Blinks for warming-up - LED can be disabled with a switch. Lights for detection - LED can be disabled with a switch. Fast blinks for recording standby Lights for recording (Max. 8sec.)
Tamper output	Dry contact relay output: NC Capacity: 30V (AC/DC), 0.5A MAX.
Pulse count settings	Once / Three times (Selectable with a switch)
Sensitivity adjustment	30% to 170% (By potentiometer)
Connection	Terminals
Ambient temperature	- 4° F to + 122° F (- 20°C to + 50°C)
Mounting position	Indoor / Outdoor (Rain-proof)
Weight	16.8 oz (480g)
Appearance	Body: ABS resin    Lens: PE resin
Accessory	Tapping screw: 2 Area masking sheet: 1
Optional	Wall mount attachment (BW-24) Pole attachment (BP-22)

# 11 EXTERNAL DIMENSIONS

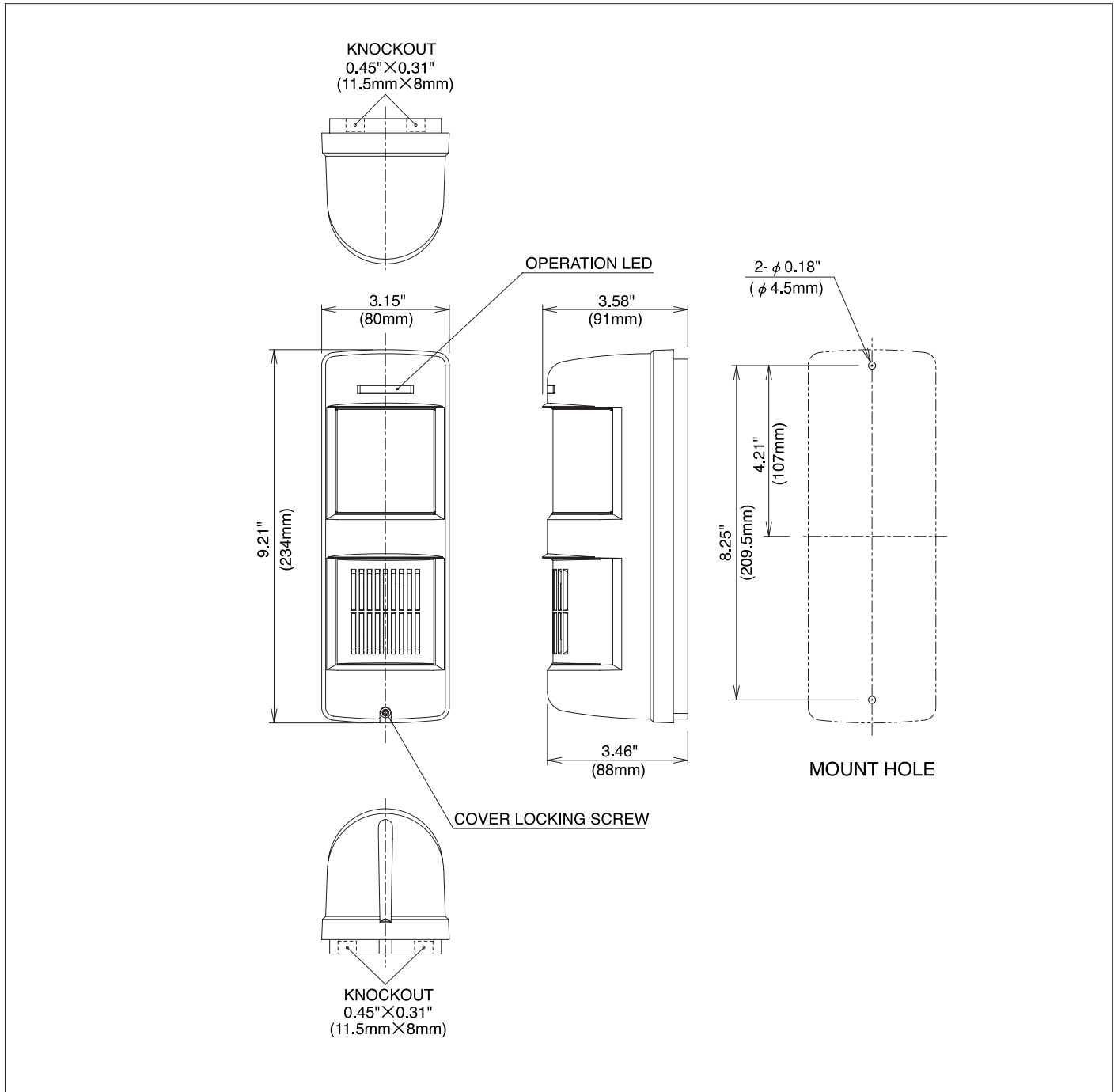

## Limited Warranty :

TAKEX products are warranted to be free from defects in material and workmanship for 12 months from original date of shipment. Our warranty does not cover damage or failure caused by Acts of God, abuse misuse, abnormal usage, faulty installation, improper maintenance or any repairs other than those provided by TAKEX. All implied warranties with respect to TAKEX, including implied warranties for merchantability and implied warranties for fitness, are limited in duration to 12 months from original date of shipment. During the Warranty Period, TAKEX will repair or replace, at its sole option, free of charge, any defective parts returned prepaid. Please provide the model number of the products, original date of shipment and nature of difficulty being experienced. There will be charges rendered for product repairs made after our Warranty Period has expired.

## TAKENAKA ENGINEERING CO., LTD.

### In Japan

**Takenaka Engineering Co., Ltd.**  
83-1, Gojo-sotokan, Higashino,  
Yamashina-ku, Kyoto 607-8156, Japan  
Tel : 81-75-501-6651  
Fax : 81-75-593-3816  
<http://www.takex-eng.co.jp>

### In the U.S.

**Takex America Inc.**  
3350 Montgomery Drive, Santa  
Clara, CA 95054, U.S.A.  
Tel : 408-747-0100  
Fax : 408-734-1100  
<http://www.takex.com>

### In Australia

**Takex America Inc.**  
Unit 16/35 Garden Road, Clayton,  
3168 Victoria, Australia  
Tel : 03-9546-0533  
Fax : 03-9547-9450

**Takex America Inc.**  
Brisbane office : 1/50 Logan  
Road, Woolloongabba  
Queensland 4102, Australia  
Tel : 07-3891-3344  
Fax : 07-3891-3355

### In the U.K.

**Takex Europe Ltd.**  
Takex House, Aviary Court, Wade Road,  
Basingstoke, Hampshire. RG24 8PE, U.K.  
Tel : (+44) 01256-475555  
Fax : (+44) 01256-466268  
<http://www.takexurope.com>