

TAKEX PHOTOELECTRIC BEAM SENSOR

PR-11BE : OUTDOOR 3.3 to 36ft. (1 to 11m)
: INDOOR 3.3 to 49ft. (1 to 15m)

Instruction Manual

Thank you for purchasing our photoelectric beam sensor.

This sensor will provide long and dependable service when properly installed.

Please read this Instruction Manual carefully for correct and effective use.

Please note : This sensor is designed to detect intrusion and to initiate an alarm ; it is not a burglary-preventing device.

TAKEX is not responsible for damage, injury or losses caused by accident, theft, Acts of God (including inductive surge by lightning), abuse, misuse, abnormal usage, faulty installation or improper maintenance.

PRODUCT DESCRIPTION

The sensor contains a transmitter and receiver.
As illustrated, an infrared beam, projected by the transmitter, is reflected back to the receiver.
The protection loop is formed along the path from the transmitter to the reflector and back to the receiver.
When this protection loop is interrupted, the receiver will initiate an alarm.

- * As this sensor needs only one-side wiring, you can use it in places where it's difficult to wire on two sides.
- * Beam alignment can be adjusted at the sensor side only.
- * Pole attachment (option parts : BP-60A) is available for both sensor and reflector.
- * L fittings (option parts : BL-11) is available for reflector mounting.

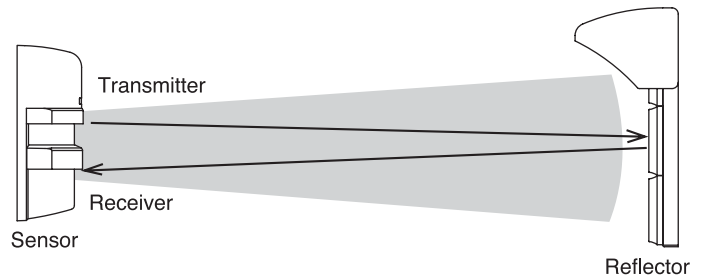

1 PARTS DESCRIPTION

SENSOR

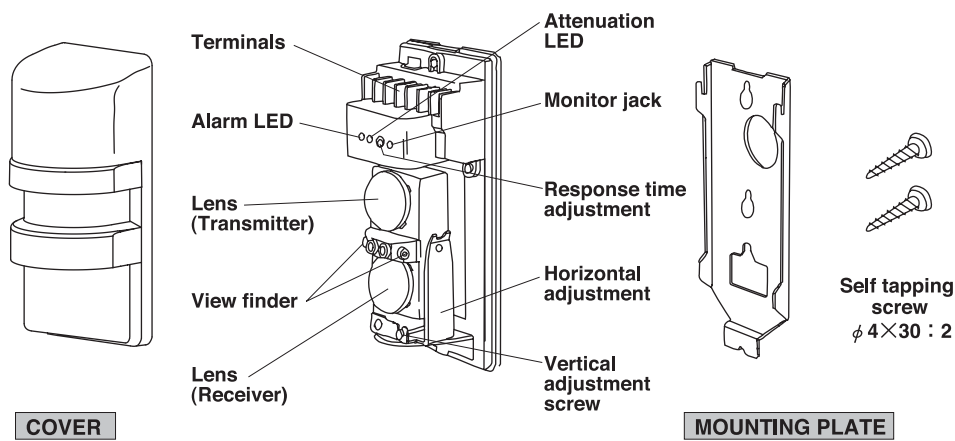

ACCESSORY

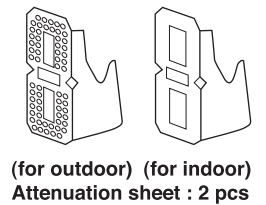

OPTION PARTS

Pole attachment (BP-60A)

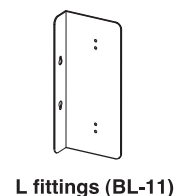
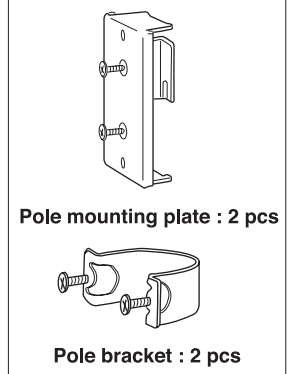

REFLECTOR ASSEMBLY

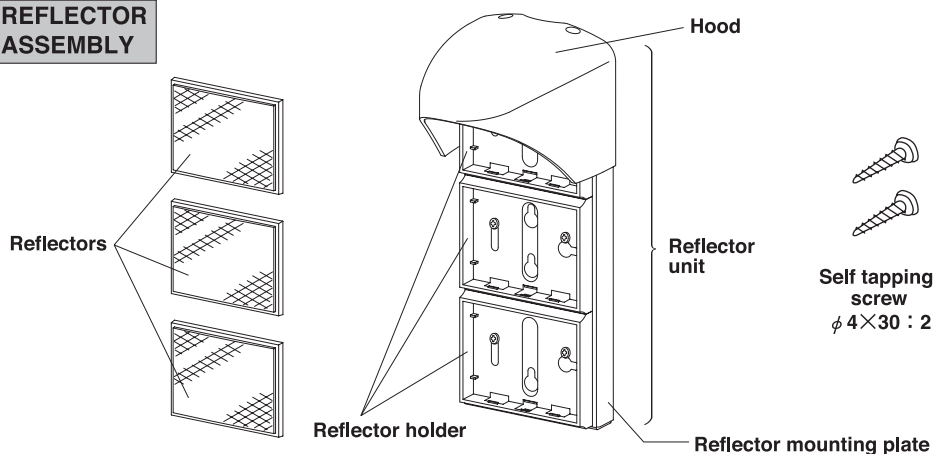

2 CAUTIONS ON INSTALLATION

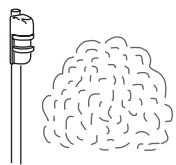

● Remove all obstructions (trees, clothes lines, etc.) between sensor and reflector.

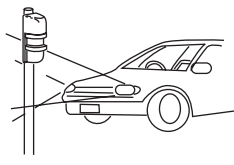

● Avoid strong light from the sun, automobile headlights etc. directly shining on sensor. When strong light stays in the optical axis for a long time, it does not cause malfunction but will affect the product life.

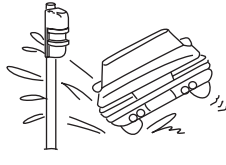

● Do not install the unit on places where it may be splashed by dirty water or direct sea spray.



● Do not install the unit on unsteady surfaces.

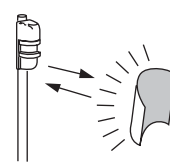

● Do not place highly reflective objects between the sensor and the reflector as they are likely to create a protection loop and prevent the sensor from making a detection.



● Hazardous weather such as heavy rain or frost may cause false alarms. Sensitivity allowance of reflective type beam sensors is comparatively lower than that of standard type beams.

PROTECTION DISTANCE

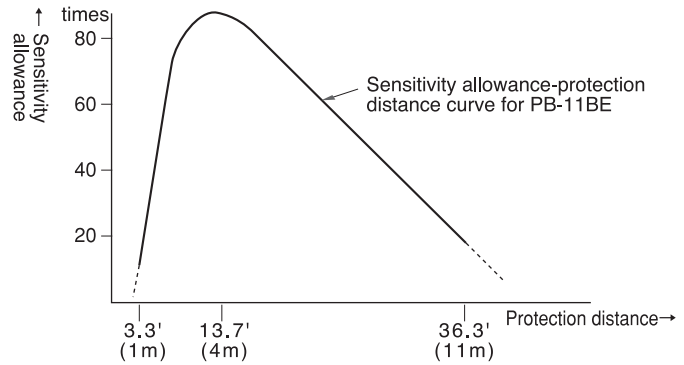
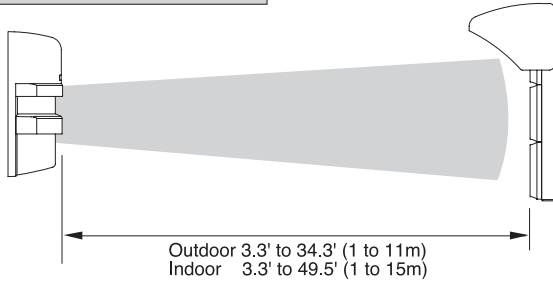

* Protection distance (between sensor/reflecter) should be placed in the rated range.

* Sensitivity allowance will be greatly decreased when the protection distance deviates from the rated range. (See the sensitivity allowance-protection distance curve for PB-11BE)

BEAM ALIGNMENT

● Fine tuning using a volt meter is required. (See section 5)

HEIGHT OF INSTALLATION

Install the sensor at a height of 31" to 39" (80 to 100cm) to catch a human target. (Install vertically so that the center of the sensor lens and middle part of the reflector assembly are placed at the same height.)

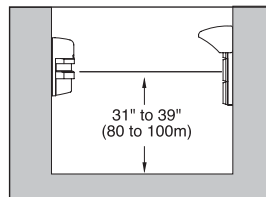

CAUTIONS ON INSTALLATION

- Avoid over head wiring.
- When installing indoors, wiring procedures similar to those for telephone or intercoms are acceptable. Outdoor wires should be placed inside conduit, or underground cable/metal shielded cable should be used.

POSITION OF INSTALLATION

Using the adjustments, the lens can move horizontally (± 90 degrees) and vertically (± 10 degrees) allowing the unit to work in all directions. (example 1 to 3)

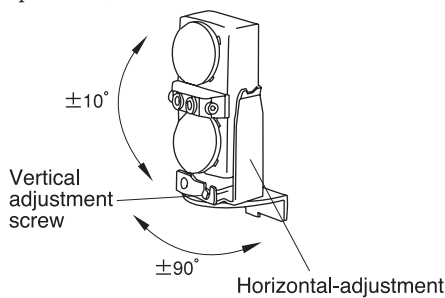

Example 1

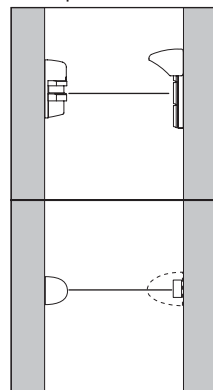

Example 2

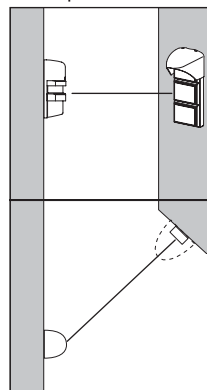

Example 3
(When BL-11 optional is used)

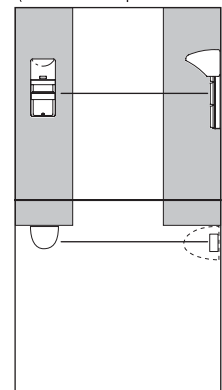

* The sensor and reflector units should be installed uprightly and vertically. Make sure that the reflector's front side faces the sensor as illustrated.

EXPANSION OF BEAM

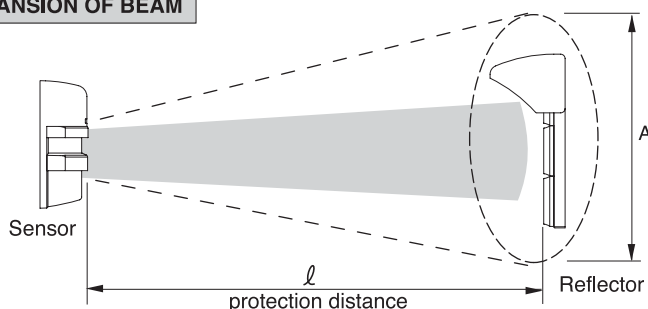

Expansion of beam can be calculated as follows.
 $A = 0.03 \times l$

l	A
16.5' (5m)	5.9" (0.15m)
36.3' (11m)	13" (0.33m)

3 WIRING

TERMINAL CONFIGURATION

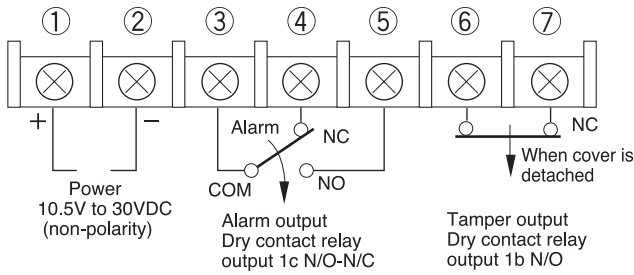

Wiring distance

Wire size	Voltage	DC12V	DC24V
AWG 22 (Dia 0.65mm)		500' (150m)	5,610' (1700m)
AWG 20 (Dia 0.8mm)		990' (300m)	9,240' (2800m)
AWG 18 (Dia 1.0mm)		1,490' (450m)	13,860' (4200m)
AWG 17 (Dia 1.1mm)		1,815' (550m)	16,830' (5100m)

Note) Maximum wiring distance when two or more sets are connected is the value above divided by the number of sets.

CONNECTION

Example connection 1

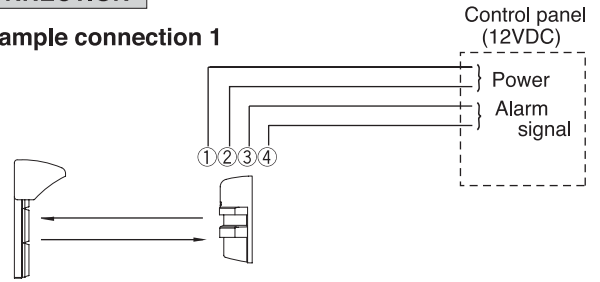

Example connection 2

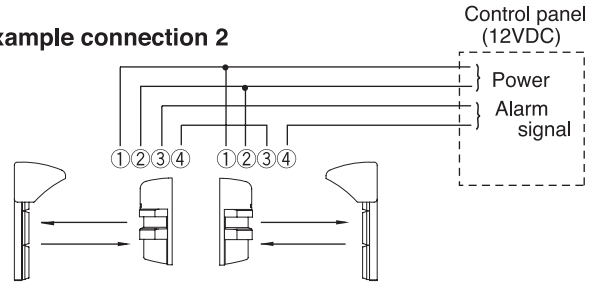

Example connection 3

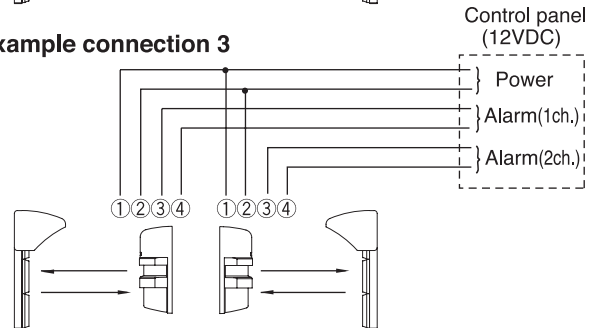

4 INSTALLATION

WALL MOUNT

Sensor

① Remove cover from unit and slide the mounting plate upwards to detach it.

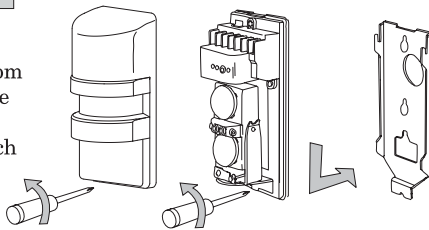

② Pull the wire through on the installation site.

③ Make one hole in the grommet on the mounting plate and pull the wire through it. Secure the plate with 4mm self tapping screws

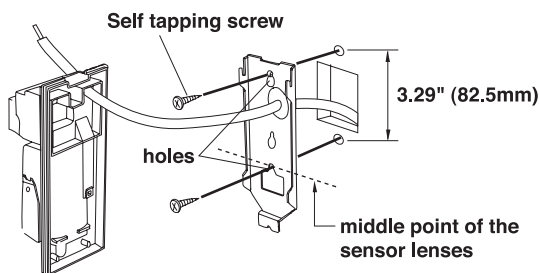

Pull the wire through the sensor body (back to front) and attach it to the terminals on the sensor.

④ When the wiring is exposed, break knockouts (2 positions) on the rear of the unit, pull the wire through as in the figure and attach it to the terminals on the sensor.

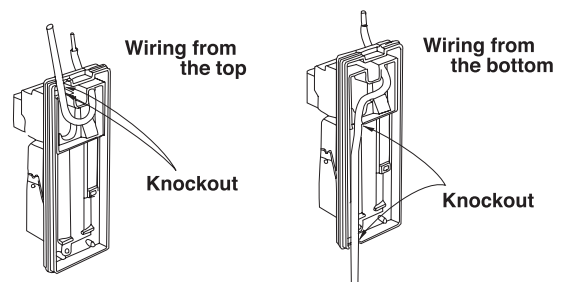

⑤ After wiring is completed, adjust alignment, attach cover and check operation. (Note: Sealing is not required for unit surround due to rain-proof construction.)

※ The grommet is compatible with a wire of $\phi 0.12"$ ($\phi 3\text{mm}$) to $\phi 0.24"$ ($\phi 6\text{mm}$) outer dia. When a wire of more than $\phi 0.24"$ ($\phi 6\text{mm}$) outer dia. is used, cut off the dotted line portion on the below figure using pliers or the like. Then use caulking to prevent insects from entering into the unit.

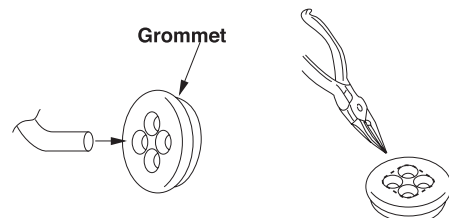

● Reflector Assembly

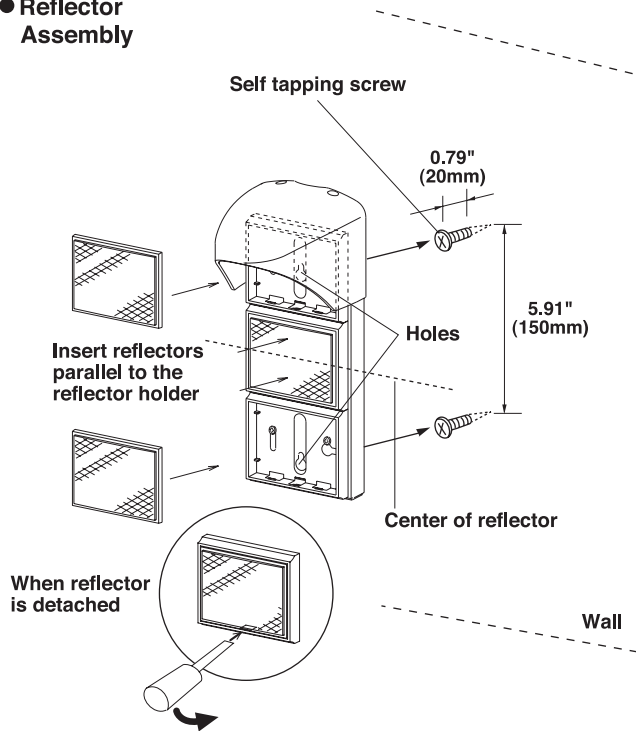

- ① Insert self tapping screws into the wall by about 0.79" (20mm) and hang the reflector unit back plate on them using the holes.

Set the center of the reflector unit and middle point of the sensor lenses at the same height, and you will find it easier to adjust alignment.

The reflector unit should be installed uprightly and vertically.

Make sure that the reflector's front side faces the sensor.

- ② Tighten the screws until the reflector unit is fixed firmly.

- ③ Fix 3 reflectors to the reflector unit firmly.

※ For indoor use, hood is not necessary.

POLE MOUNT

※ Use outside dia. 1.50" (38mm) to 1.77" (45mm) pole.

- ① Insert 2pcs. of oval countersunk head screws (M4×20) into the pole bracket with a few turns.
- ② Fix pole mounting plate to pole with the pole bracket.
- ③ Fix sensor mounting plate or reflector mounting plate on the pole mounting plate with 2pcs of M4×6 screws attached to it.

SENSOR

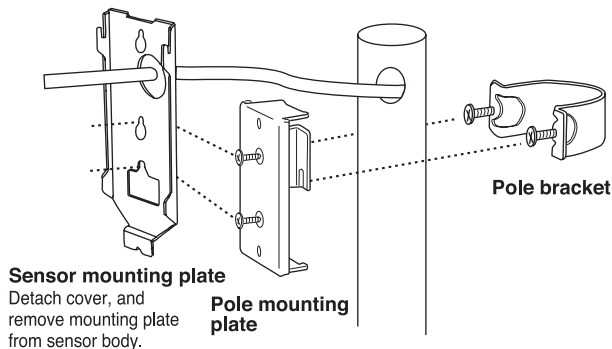

- Follow the same procedure as ③ to ⑤ of wall mount.

REFLECTOR

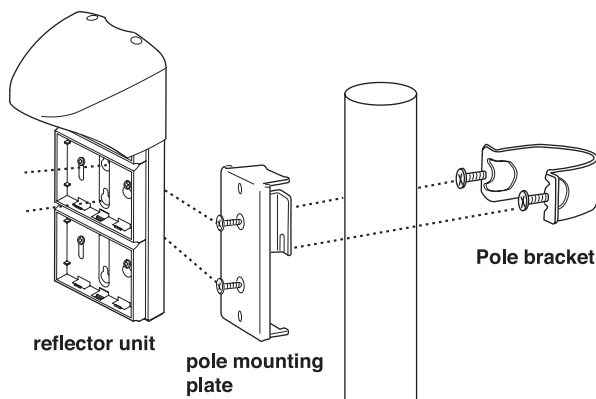

- Follow the same procedure as wall mount.

BACK TO BACK POLE MOUNT AND RIGHT ANGLE POLE MOUNT

- ① First, fix the pole mounting plate for the 1st unit.
- ② Let the 2nd unit pole bracket run under the 1st unit pole mounting bracket and fix the 2nd pole mounting plate up side down.

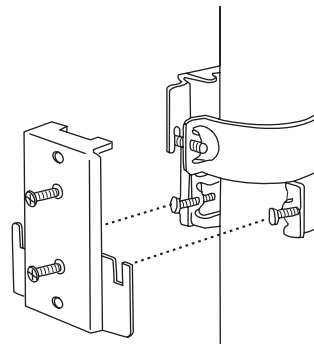

- Follow the same procedure as ③ to ⑤ of wall mount.
- Not applicable for the reflector.

5 ALIGNMENT AND OPERATION

BEAM ALIGNMENT

- ① Face the sensor lenses to the reflector with its cover detached.
Adjust the angle of the sensor unit vertically and horizontally by looking through the view finder placed between the sensor lenses.
Adjust it until the center of the reflector can be seen in the middle of the view finder.
- ② Supply power to the sensor.
When the sensor and reflector are properly installed at the same height, alarm LED will remain OFF.
- ③ After confirming that the alarm LED is OFF, place the attenuation sheet on the optics of the sensor and check if the attenuation LED is OFF.
Please note that there are two types of attenuation sheets. (indoor use and outdoor use)
- 4) If the attenuation LED lights, make adjustment again until it turns OFF.
- 5) Fine tuning should be done by monitoring the output voltage using a volt meter.

(See the table below.) until obtaining the peak voltage.

Monitor output voltage	Beam level (outdoor, indoor)
2.6V or more	Best
1.4 to 2.6V	Good
less than 1.4V	Re-adjustment

- Note :
- The above voltage shows the monitor output when the lenses are covered by the attenuation sheet.
 - Using the attenuation sheet and a voltmeter ensures optimum performance of the sensor.

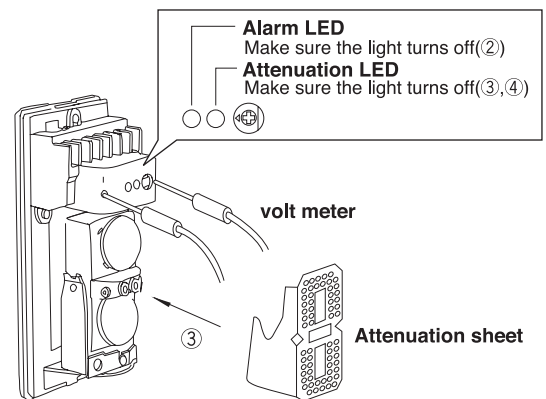
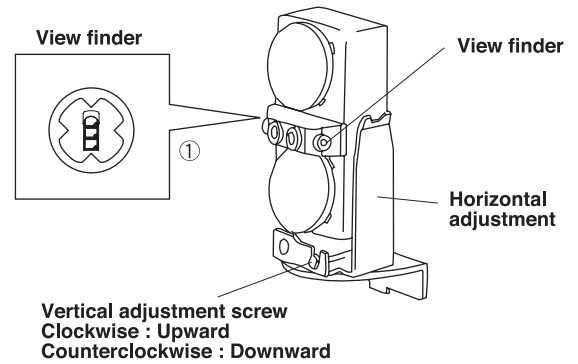

OPERATION CHECK

- After installing the sensor and making the alignment adjustment, check the operation of the sensor with its cover attached by looking at the alarm LED on the sensor.
- ① Make sure that the alarm LED is OFF.
 - ② When the infrared beam is interrupted, the alarm LED lights.
It indicates that the operation is normal.
The relay operates during the interruption time for a minimum of 2 seconds.
 - ③ Walk through the infrared beam between the sensor and the reflector and make sure that the alarm LED lights up and then goes off.

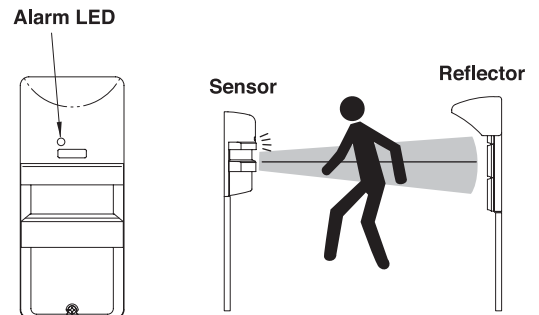

6 RESPONSE TIME

Adjust response time as follows. The unit does not detect a passing object faster than the response time setting. If the response time is set longer, the unit does not detect human beings. Adjust to a little longer response time in a site where large passing objects, such as birds, newspaper or falling leaves may pass through the beam path.

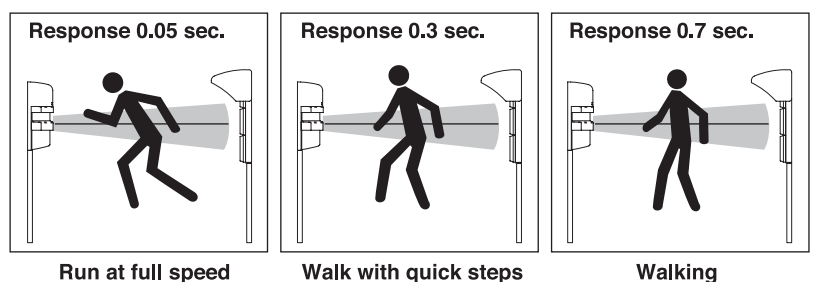
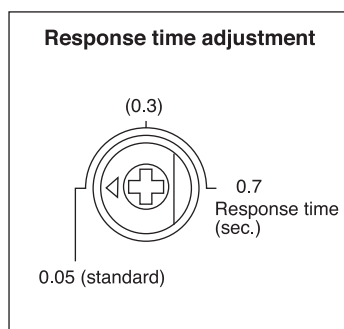

- Note : • Unreasonably longer response time may cause undetection of a human being.

7 TROUBLESHOOTING

Symptom	Possible cause	Remedy
Alarm LED does not light when the beam is broken.	1) No power supply. 2) Bad wiring connection or broken wire, short. 3) Beam is reflected on another object and sent into the receiver.	1) Turn on the power supply. 2) Check wiring. 3) Remove the reflecting object or change beam direction.
Alarm LED continues to light.	1) Beam alignment is out. 2) Shading object between sensor and reflector. 3) Sensor cover or reflector are soiled.	1) Check and adjust again. 2) Remove the shading object. 3) Clean them with a soft cloth. (Except the cover) <i>*Do not clean the cover with a cloth. Just wash it away with water.</i>
Intermittent alarm	1) Bad wiring connection. 2) Change of supply voltage. 3) Shading object between sensor and reflector. 4) A large electric noise source, such as power machine, is located nearby sensor. 5) Unstable installation of sensor and reflector. 6) Sensor cover or reflector are soiled. 7) Improper alignment. 8) Small animals may pass through the beams.	1) Check again. 2) Stabilize supply voltage. 3) Remove the shading object. 4) Change the place for installation. 5) Stabilize. 6) Clean them with a soft cloth. 7) Check and adjust again. 8) Set the response time longer. (Do not use this setting where an intruder can run at full speed through the beam.)

<Daily check> Check the operation of the unit once a week.

When the cover is stained, just wash it away with waters.

Never clean it with a cloth otherwise it could damage the photocatalytic antifouling film attached on the sensor cover.

The film is designed to prevent attenuation of the infrared caused by the stain or the waterdrop from torrential rain.

8 SPECIFICATIONS

Model	PR-11BE
Detection system	Near infrared beam interruption system (reflective)
Protection distance	Outdoor 3.3 to 36' (1 to 11m) Indoor 3.3 to 49' (1 to 15m)
Supply voltage	10.5V to 30V DC (Non-polarity)
Current consumption	55mA or less
Alarm output	Dry contact relay from N/O-N/C Contact capacity : 30V (AC/DC) 0.5A or less Relay operation : Interruption time (minimum 2 seconds)
Tamper output	Dry contact relay 1b (N/C) Action : Activated when cover is detached. Contact capacity : 30V (AC/DC) 0.5A or less
Response time	0.05sec to 0.7sec. (Adjustable by potentiometer)
Alarm LED	Red LED ON : when an alarm is initiated
Attenuation LED	Red LED ON : when beam is attenuated
Functions	Monitor output
Ambient temperature range	-13° F to + 140° F (-25°C to +60°C)
Mounting positions	Outdoor/Indoor
Wiring	Terminals
Weight	Sensor : 15oz (430g) Reflector : 17oz (490g)
Appearance	Sensor : PC resin(wine red) Reflector : acrylic resin (clear), AES resin (black)
Accessory	Self tapping screw $\phi 4 \times 30 : 4$ Attenuation sheet : 2pcs (for outdoor, for indoor)

●Specifications are subject to change without notice.

LIMITED WARRANTY

TAKEX products are warranted to be free from defects in material and workmanship for 12 months from original date of shipment. Our warranty does not cover damage or failure caused by Acts of God, abuse, misuse, abnormal usage, faulty installation, improper maintenance or any repairs other than those provided by TAKEX. All implied warranties with respect to TAKEX, including implied warranties for merchantability and implied warranties for fitness, are limited in duration to 12 months from original date of shipment. During the Warranty Period, TAKEX will repair or replace, at its sole option, free of charge, any defective parts returned prepaid. Please provide the model number of the products, original date of shipment and nature of difficulty being experienced. There will be charges rendered for product repairs made after our Warranty Period has expired.

9 EXTERNAL DIMENSIONS

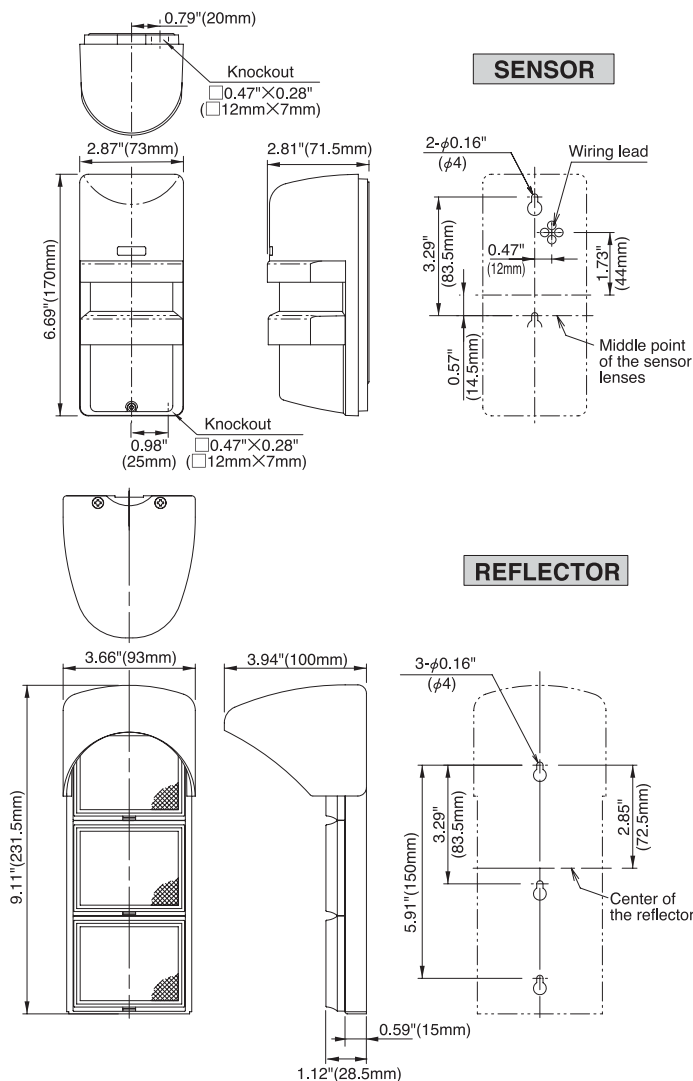

TAKEX TAKENAKA ENGINEERING CO., LTD.

In Japan
Takenaka Engineering Co., Ltd.
 83-1, Gojo-sotokan, Higashino,
 Yamashina-ku, Kyoto 607-8156, Japan
 Tel : 81-75-501-6651
 Fax : 81-75-593-3816
<http://www.takex-eng.co.jp/>

In the U.S.
Takex America Inc.
 230E, Caribbean Drive
 Sunnyvale, CA 94086, U.S.A.
 Tel : 408-747-0100
 Fax : 408-734-1100
<http://www.takex.com>

In Australia
Takex America Inc.
 Unit 16/35 Garden Road, Clayton,
 3168 Victoria, Australia
 Tel : 03-9546-0533
 Fax : 03-9547-9450

Takex America Inc.
 Brisbane office : 1/50 Logan
 Road, Woolloongabba
 Queensland 4102, Australia
 Tel : 07-3891-3344
 Fax : 07-3891-3355

In the U.K.
Takex Europe Ltd.
 Takex House, Aviary Court, Wade Road,
 Basingstoke, Hampshire. RG24 8PE, U.K.
 Tel : (+44) 01256-475555
 Fax : (+44) 01256-466268
<http://www.takexeuropa.com>