

TAKEX PASSIVE INFRARED SENSOR

PA-5312E (Wide angle protection : 40ft [12m]) • PA-5325E (Vertical curtain protection : 82ft [25m])

Instruction Manual

We appreciate your purchase of a TAKEX passive infrared sensor. This sensor will provide long and dependable service when properly installed. Please read this Instruction Manual carefully for correct and effective use.

Please Note : This sensor is designed to detect intrusion and to initiate an alarm ; it is not a burglary-preventing device.

TAKEX is not responsible for damage, injury or losses caused by accident, theft, Acts of God (including inductive surge by lightning), abuse, misuse, abnormal usage, faulty installation or improper maintenance.

1 PARTS DESCRIPTION

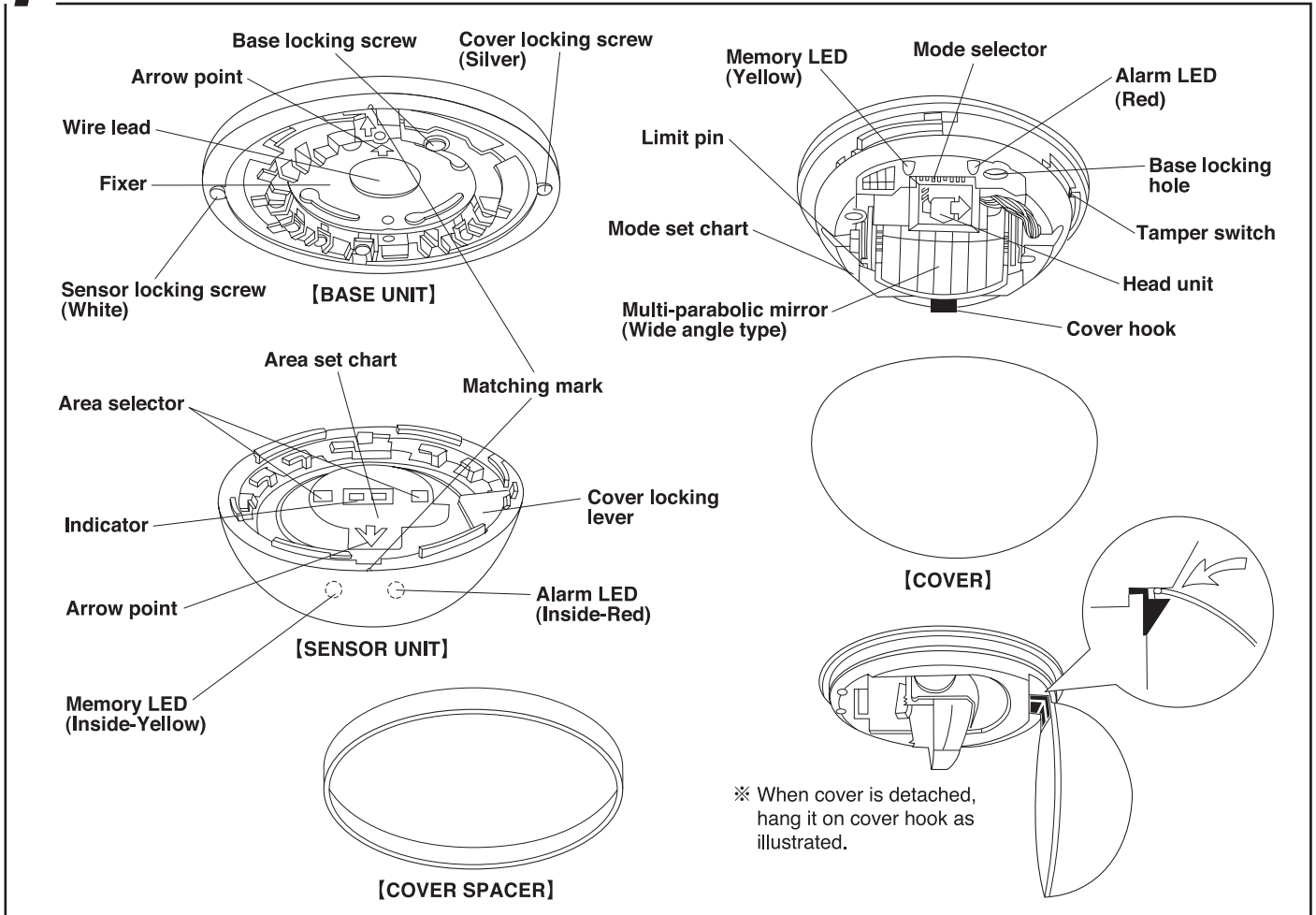

2 DO'S AND DON'T'S

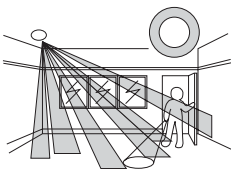

● Install the sensor in a location such that intruders are more likely to cross the protection zones, rather than approach head on.

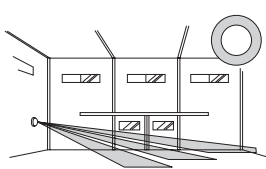

● When there is a very high ceiling, such as a warehouse, wall mount the unit.

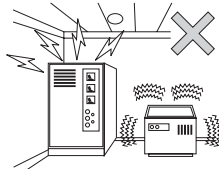

● Do not install in a site which is subject to electrical noise or intense vibration.

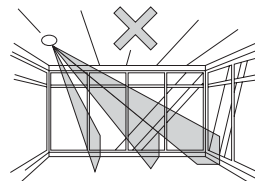

● Avoid direct sunlight, spot light or intense reflections on the sensor or the protection zone.

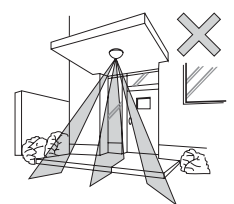

● Do not install the sensor outdoors (indoor use only).

[MAINTENANCE]

1. When the unit is soiled, clean the cover with a soft cloth moistened with a small amount of cleansing solution. Do not use chemicals such as thinners or alcohol.
2. Check operation once a week. Do not fail to check operation whenever furniture in coverage area is moved.

● The passive infrared sensor is designed to detect infrared energy variations caused by the presence of a human body. Therefore, note that similar variations in conditions in protection area, due to other reasons, may cause the sensor to create an alarm as it is unable to distinguish between sources.

3 COVERAGE AND RANGE

Wide angle protection

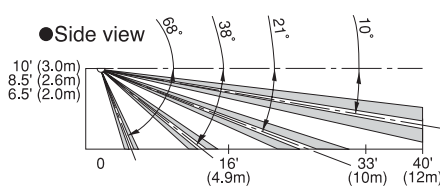
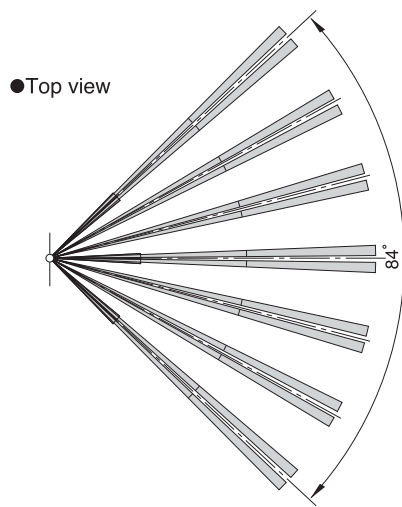

Max. coverage when ceiling mounted.
Installation height 10' (3m) : SETTING [E]

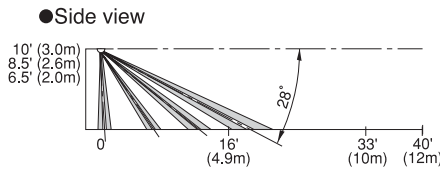

Min. coverage when ceiling mounted.
Installation height 10' (3m) : SETTING [N]

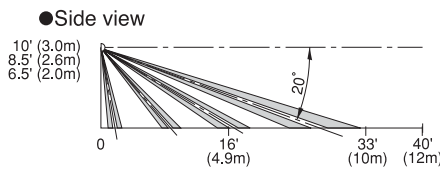

Min. coverage when wall mounted.
Installation height 10' (3m) : SETTING [10]

Vertical curtain protection

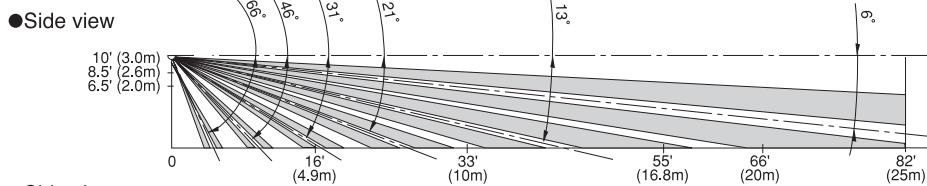
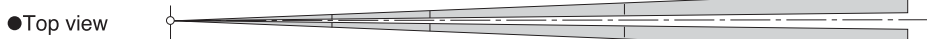

Max. coverage when ceiling mounted.
Installation height 10' (3m) : SETTING [C]

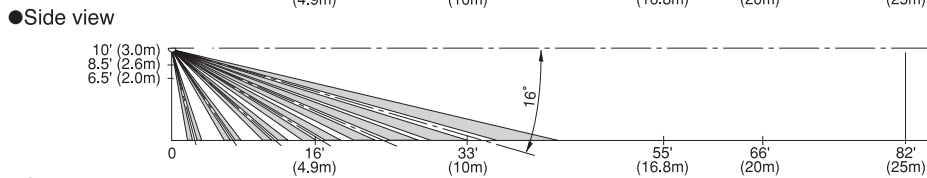

Min. coverage when ceiling mounted.
Installation height 10' (3m) : SETTING [H]

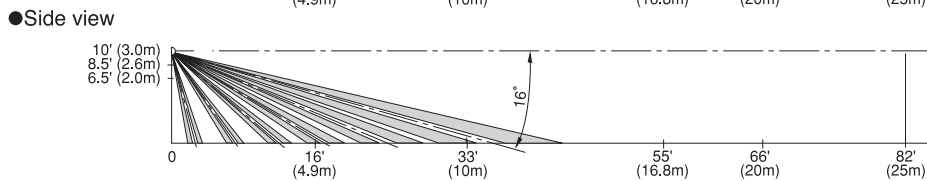

Min. coverage when wall mounted.
Installation height 10' (3m) : SETTING [8]

4 WIRING

[Terminal arrangement]

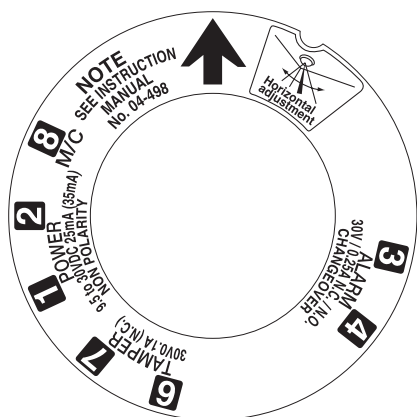

- | | | | |
|----------|----------|--|---|
| 1 | 2 | POWER (non-polarity)
9.5V to 30V DC | } N/C contact : 25mA or less
N/O contact : 35mA or less |
| 3 | 4 | ALARM OUTPUT
Dry contact relay | |
| 6 | 7 | TAMPER
Dry contact | } N/C contact
Operation : Open when cover, sensor unit
is detached.
30V (AC/DC) 0.1A or less |
| 8 | | M/C MEMORY | |

[Basic connection]

[When two units are used]

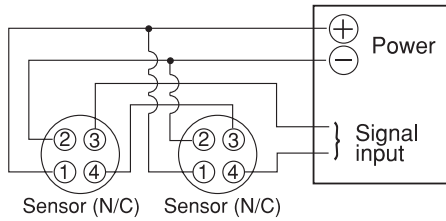

[Allowable wiring distance between sensor and power source]

Size of wire used	Distance at 12VDC
AWG 22 (Dia. 0.65mm)	820 ft. (250m)
AWG 20 (Dia. 0.80mm)	1,476 ft. (450m)
AWG 18 (Dia. 1.00mm)	2,296 ft. (700m)

Note 1) The maximum wire length, when two or more units are connected, is the above distance divided by the number of units.

2) The protection circuit can be wired to a distance of 3,280 ft (1,000m) with AWG 22 (0.65mm dia.) wire.

* Allow approx. one minute for warm-up after power is applied. (Alarm LED is flashing) In the meantime, an alarm is not initiated.

* After the one minute has passed the unit will be in the armed condition and will trigger when detecting a human body.

5 INSTALLATION

CEILING MOUNT

Loosen sensor locking screw, turn the sensor unit counter-clockwise and it will come off easily.

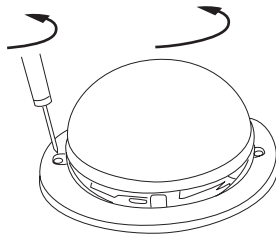

Attach the base unit with the arrow pointing to the detected area.

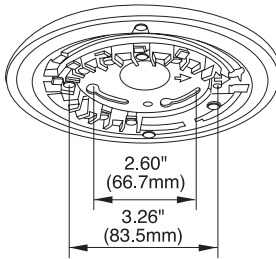

Refer to "4 WIRING" and connect terminals.

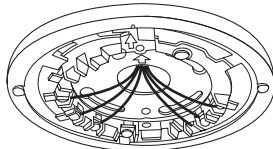

Attach sensor unit to the base unit, match up marks and tighten the screw.

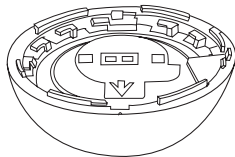

Refer to "6 AREA SETTING" and set area by area selector.

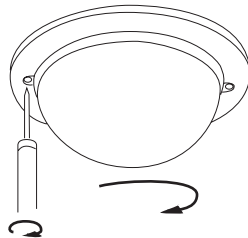

WALL MOUNT OR INSTALLING ON INCLINED FACE

Attach the base unit with the arrow pointing to ceiling direction.

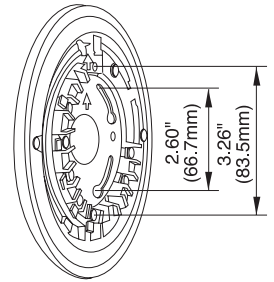

Refer to "4 WIRING" and connect terminals. Twist cover counter-clockwise, while pushing cover locking lever as the figure, to detach cover.

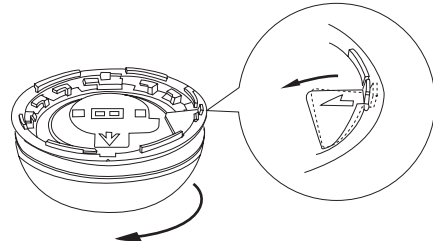

Snap off limit pin near the parabolic mirror, which release the mirror to turn to wall mount area. Set area by area selector.

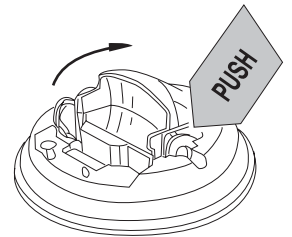

Put the cover on the channel of cover spacer (accessory).

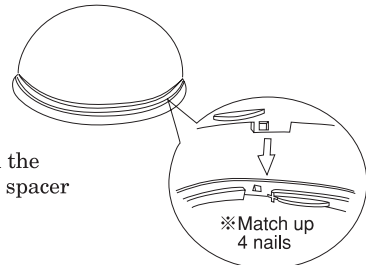

Push cover slowly and closely on an even surface.

Attach the cover with spacer on the base unit, match up marks and tighten the screw.

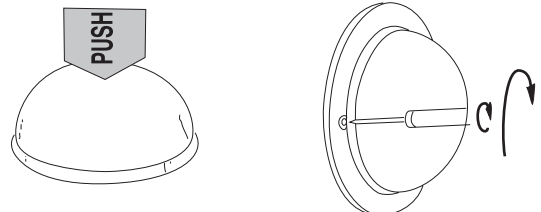

6 AREA SETTING

[PA-5312E] ■ Ceiling mount

DISTANCE	13	16	20	23	26	30	33	36	40		
	ft.	m	4.0	4.9	6.0	7.0	7.9	9.0	10.0	11.0	12.0
CEILING	6.5	2.0	G	F	E	E	D	C	C	C	C
	8.5	2.6	K	I	H	G	G	F	E	E	D
	10	3.0	N	L	J	I	H	G	F	F	E
13	4.0				N	L	K	J	I	H	G

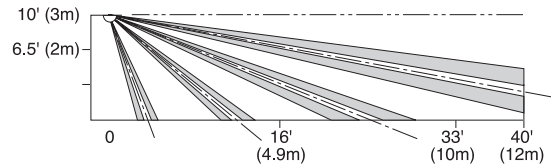
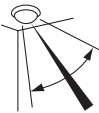

(Ex.) In case of 10' (3m) ceiling mount height and 40' (12m) range, selector should be set at E.

■ Wall mount

DISTANCE	13	16	20	23	26	30	33	36	40		
	ft.	m	4.0	4.9	6.0	7.0	7.9	9.0	10.0	11.0	12.0
WALL	6.5	2.0	7	6	5	5	4	4	3	3	3
	8.5	2.6	11	9	8	7	7	6	5	5	4
	10	3.0			10	9	8	7	6	6	5
13	4.0					11	10	9	8	7	

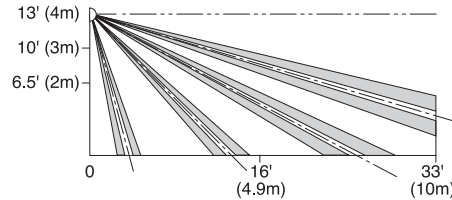

(Ex.) In case of 13' (4m) wall mount height and 33' (10m) range, selector should be set at 9.

[PA-5325E] ■ Ceiling mount

DISTANCE	25	33	40	45	55	60	66	75	82		
	ft.	m	7.6	10.0	12.0	13.7	16.8	18.3	20.0	23.0	25.0
CEILING	6.5	2.0	D	C	C	B	B	B	A	A	A
	8.5	2.6	F	E	D	D	C	C	B	B	B
	10	3.0	H	F	E	E	D	D	C	C	C
13	4.0	K	I	G	F	E	E	D	D	D	

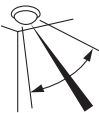

(Ex.) In case of 10' (3m) ceiling mount height and 82' (25m) range, selector should be set at C.

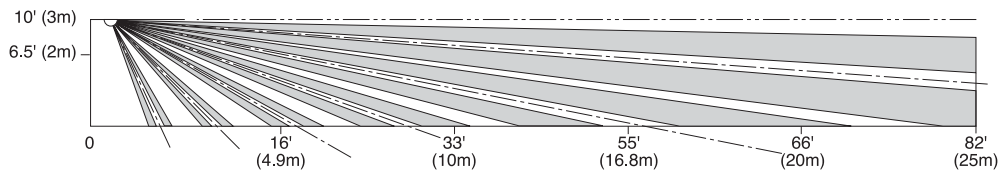

■ Wall mount

DISTANCE	25	33	40	45	55	60	66	75	82		
	ft.	m	7.6	10.0	12.0	13.7	16.8	18.3	20.0	22.8	25.0
WALL	6.5	2.0	4	3	3	2	2	2	1	1	1
	8.5	2.6	6	5	4	4	3	3	2	2	2
	10	3.0	8	6	5	5	4	4	3	3	3
13	4.0	11	9	7	6	5	5	4	4	4	

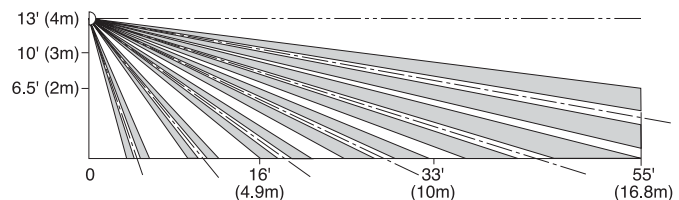

(Ex.) In case of 13' (4m) wall mount height and 55' (16.8m) range, selector should be set at 5.

Vertical adjustment

Coverage can be set by turning area selector in accordance with area set chart on the back of sensor unit.

Horizontal adjustment

Loosen base unit locking screw and rotate sensor unit horizontally for adjustment.

7 OPERATION CHECK

When installation is completed, turn the power "ON" and check operation as follows after about 1min. warming up time.

1. Make sure that Alarm LED finishes flickering.
2. Walk test in the protected area to check if an alarm is initiated.
Check alarm LED and control panel for sensor operation.
3. After correct operation has been confirmed, use the mode selector inside the sensor unit to disable the alarm LED, if required.

8 ADJUSTMENT OF THE FIELD VIEW

When operation check proves improper area setting, visually check its area setting.

- (1) Loosen cover locking screw to detach cover.

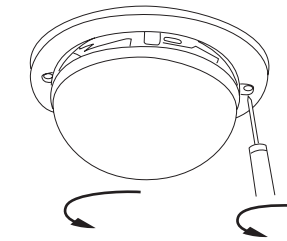
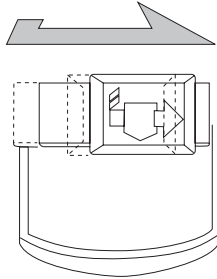

- (2) Slide the head unit to bring the sensor unit into aiming position. Slip to the arrow direction and it will be automatically locked at testing position.

- (3) Adjust the coverage by moving the mirror so that LED on the head unit is visible through mirror from location to be protected.

* Adjust so that center of sensitive zone should be positioned at human waist height.

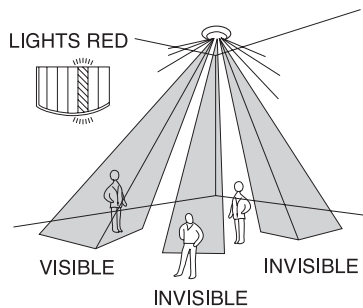

ADJUST UNDER AIMING POSITION

HORIZONTAL ADJUSTMENT

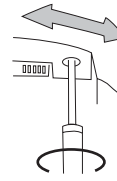

- * Insert screwdriver in the base locking hole and loosen the locking screw. Adjust by rotating sensor unit. After adjustment, tighten the locking screw.

VERTICAL ADJUSTMENT

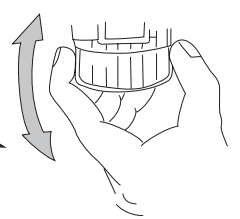

- * Hold the parabolic mirror with hard and rotate it for adjustment. Do not touch the mirror face.

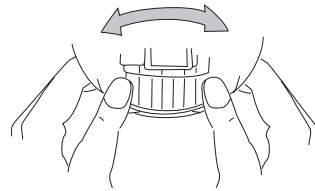

- * Hold the parabolic mirror with both hands push $\Delta\Delta\Delta$ portion for horizontal fine tuning. (When wall mounted, this is horizontal adjustment.)

- (4) After adjustment is completed, lightly push head unit. It will replace to the armed position automatically.

- * When head unit is placed at testing position, alarm LED lights and alarm output continuously outputs (Trouble alarm).

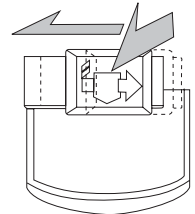

9 MODE SETTING

Sensor operation can be adjusted to fit the environmental / applications with the built-in mode selector.

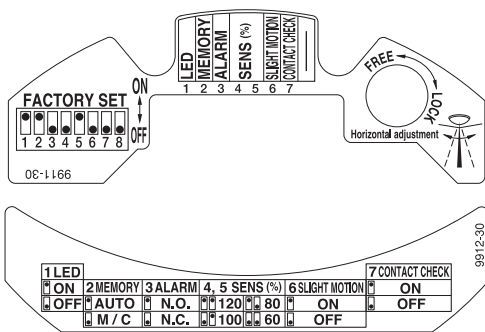

ALARM LED

The alarm LED will light up synchronized with the alarm contact if you set the mode selector at ON. This disables the alarm LED even if an alarm is initiated. Turn OFF alarm LED with the mode selector after operation check is completed.

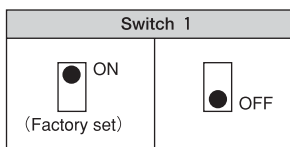

ALARM MEMORY

Memory LED will inform you which sensor initiated an alarm during alert condition when two or more sensors are connected on the same line. Select and set the optimal mode in accordance with application.

Auto-reset mode:

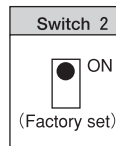

- Set up** : Wire power + terminal with M/C terminal. Set switch 2 at "AUTO".
- Operation** : Memory is always stored when sensor is armed. When an alarm has been activated, the memory LED flashes for 3 min. and then remains lit for 47 min. It automatically reset and memory is also canceled. In case that

Manual control memory:

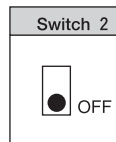

- Set up** : Wire power + terminal with M/C terminal through contact switch which is placed nearby controls. Set switch 2 at "M/C".
- Operation** : When the sensor is armed, turn the contact switch on to set memory function ON. When an alarm is activated during armed condition, memory is stored. A sensor that has initiated an alarm in protection condition lights its LED continuously when protection is released and contact switch is turned OFF. When again turning the contact switch ON after checking the indication, the indication is over and memory is canceled.

* Unless alarm memory function is used, turn OFF the mode-selector 2 and leave the alarm memory terminal [8] unconnected.

ALARM CONTACT CHENGEOVER

Change alarm contact to N/O when sensor is used for an application except security purpose, such as light control.

NOTE : Current consumption of sensor increases at N/O position.

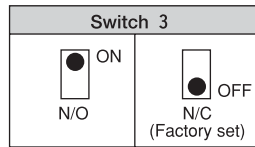

SETTING OF SENSITIVITY

When operation check reports you high sensitivity of sensor, change setting of sensitivity with mode selector and re-check operation. Four settings are available.

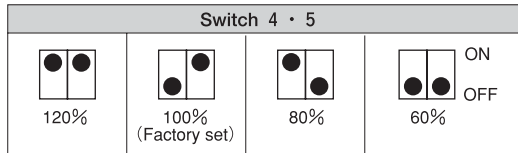

A SLIGHT MOTION DETECTION

Make use of a slight motion detection (motion of hands or body) at a narrow range.

NOTE : This mode is so sensible to detect even a slight motion that the performance to discriminate small animals might be low.

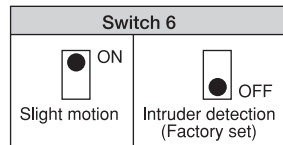

ALARM CONTACT CHECK FUNCTION

This function is to check trouble on alarm contact (staking or damage).

When an alarm relay does not work normally though inner alarm signal works normally, the alarm LED flickers to indicate trouble.

Check and remedy in accordance with trouble shooting list when the alarm LED flickers.

NOTE : This check function works regardless of the other mode settings.

Do not fail to use for 1 unit of sensor on a line.

It may go to trouble indication for normal operation in case of connecting two or more sensors on the same line.

NOTE : 5V, 5mA or more is required for alarm signal line.

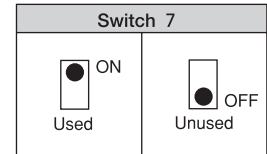

FACTORY SET

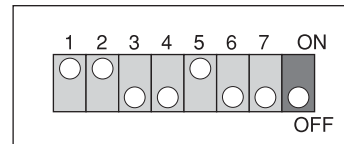

*8 unused (Set switch 8 at OFF)

10 FEATURES DESCRIPTION

Built-in CPU automatically checks/monitors sensor unit function. The check and the monitor function regardless of mode settings except a part of features.

TROUBLE INDICATION

A sensor checks monitors the sensor unit itself in accordance with built-in program.

When trouble is found out as a result of the check / monitor, alarm LED continuously flickers (as a visual alarm).

1 : Alarm contact check function (mode selector [7] : ON)

This function is to check trouble on alarm contact (staking or damage).

When alarm relay does not work normally though inner alarm signal works normally, alarm LED flickers to indicate the trouble.

NOTE : This check function works regardless of the other mode settings.

Do not fail to use for 1 unit of sensor on a line. It may go to trouble indication for normal operation in case of connecting two or more sensors on the same line.

NOTE : 5V, 5mA or more is required for alarm signal line.

NOTE : Trouble indication will keep on flickering until power is reset or next checking confirms no problem. See troubleshooting and remedy table.

TROUBLE ALARM

A sensor checks / monitors sensor unit itself in accordance with built-in program.

When trouble is found out as a result of the check / monitor, alarm LED lights and an alarm output also continuously outputs.

1 : Unit trouble

Trouble alarm triggers when inner circuit / wiring is damaged / broken.

See 11, troubleshooting and remedy table.

NOTE : The monitor functions regardless of mode settings but an alarm is not indicated in case of setting alarm LED at OFF position. When power is reset during the alarm status, trouble alarm stops for warming up time only.

2 : Low voltage

When power voltage of sensor drops down (approx. 8.5V DC or less), trouble alarm triggers before sensor operation comes to be unstable due to low voltage.

See troubleshooting and remedy table.

NOTE : The monitor functions regardless of mode settings but an alarm is not indicated in case of setting alarm LED at OFF position. When power voltage recovers to normal level during the alarm status, trouble alarm stops.

3 : Failure to replace

Trouble alarm triggers to prevent failing to replace sensor head unit which is set for aiming. An alarm stops when the sensor head unit is replaced to alert position.

NOTE : The monitor functions regardless of mode settings, but an alarm is not indicated when alarm LED is set to OFF position.

11 TROUBLESHOOTING

Analyze possible problems according to the following table.

If normal operations cannot be restored by this means, contact either the dealer from whom you bought the unit or TAKEX.

Trouble	Possible cause	Corrective action
Completely inactive	●Either power is OFF (including broken cable) or power voltage is too low.	●Check the power cable and adjust power voltage properly.
	●Not yet 1 min. after power turned on. (Is alarm LED flickering ?)	●Allow for warm-up time.
	●There is an obstacle in front of the detection area.	●Remove the object.
	●Improper detection area adjustment.	●Readjust the detection area setting.
Sometimes inactive.	●Improper detection area adjustment .	●Readjust the detection area setting.
	●Cover surface soiled.	●Clean cover with a soft cloth. (Do not use thinner, etc.)
	●The detection range exceeds. 12m (wide angle) 25m (Vertical curtain)	●Reposition so that the range is less than 40ft. (12m) (wide angle) or 82ft. (25m) (vertical curtain)
Activated when no person has passed.	●Improper power supply.	●Correct power supply.
	●Something moving in protected area or too rapid temperature variations.	●Remove the cause.
	●A source of electrical noise (broadcasting station, amateur radio etc.) nearby.	●Change the installation location.
	●Strong sunlight reflection or direct light hitting the unit.	●Change the installation location. ●Shield sunrays with a blind.
	●The detector reacts to passersby outside.	●Readjust the detection area.
Alarm LED lights, though connected units are inactive.	●Poor contact output connection or broken wire.	●Check the wiring.
	●Connected units are damaged.	●Check connected units.
	●Damaged alarm contact.	●Check alarm output terminals with tester.
Alarm LED continues to be flickering. (Trouble indication)	●Mode selector (7) is not turred ON.	●Damaged alarm contact. Check alarm terminals with tester.
Alarm LED continues to light and alarm continues to be initiated. (Trouble alarm)	●Head unit fails to be replaced.	●Replace to armed position.
	●Too low power voltage.	●Adjust power voltage properly.
	●Trouble alarm initiated again after warming-up period,though power is reset.	●There is a possibility of inner broken wire/damage.

※TAKEX passive infrared sensor is designed to detect infrared energy variation caused by the presence of a human body. Therefore, note that similar variations in conditions in the protected area, due to other reasons, may cause the sensor to create an alarm as it is unable to distinguish between sources.

MAINTENANCE

- 1) If the sensor is stained, wipe it lightly with a soft cloth moistened with a small amount of soap solution. Never try to clean it with thinner or alcohols.
- 2) Check the functioning of the sensor once a week. Using the walk test procedure described under the 7. operation check section. This check should also be carried out whenever the protected area has been altered or if desks or screens, etc. have been relocated.

12 SPECIFICATIONS

13 EXTERNAL DIMENSIONS

Passive infrared sensor	
Model	PA-5312E PA-5325E
Detection system	Passive infrared (QUAD)
Coverage	Wide angle protection 40' (12m) Max. Vertical curtain protection 82' (25m)Max.
Sensitive zone	72 (18 pairs) 24 (6 pairs)
Supply voltage	9.5V to 30V DC (non-polarity)
Current consumption	N/C contact : 25mA Max. N/O contact : 35mA Max.
Alarm output	Dry contact relay (N/C, N/O changeover) Reset : Approx. 2 sec. 30V (AC/DC) 0.25A Max. (protective resistor 3.3Ω)
Tamper output	Dry contact relay (type N/C) Open when cover or body is detached 30V (AC/DC) 0.1A Max.
Alarm memory	Auto-reset memory : 3min. -Flickering, 47min. -Lighting Manual memory : Memory disabled / indication / reset control by using terminal 8
Slight motion detection	Sensitive zone : 36 pairs Sensitive zone : 12 pairs
AlarmLED	Red LED Flickering (every 0.5 sec.) : Warming-up Lighting (approx.2sec.) : Alarm Flickering (every 0.25 sec.) : Trouble indication Continuous lighting : Trouble alarm (Disabled is LED except trouble indicaiton)
Memory LED	Yellow LED Flickering : Memory activated Lighting : Memory indicated
Trouble indication	Alarm contact checking whenever an alarm outputs ●Operation : Trouble indication
Trouble signal	Unit trouble : Monitoring inner circuit and wiring damage ●Operation : Trouble alarm Low voltage trouble : Monitoring low voltage ●Operation : Trouble alarm Positioning trouble : Monitoring failure to replace view finder ●Operation : Trouble alarm
Ambient temperature range	+14° F to +131° F (without dewdrops) (-10° C to +55° C)
Mounting position	Indoor (ceiling / wall)
Wiring connections	Terminals
Weight	8.75 oz (250g)
Appearance	Body : ABS resin Cover : PE resin
Adjustment range	Ceiling mount : Vertically 26° Horizontally ±15° Wall mount : Vertically 20° Horizontally ± 5°

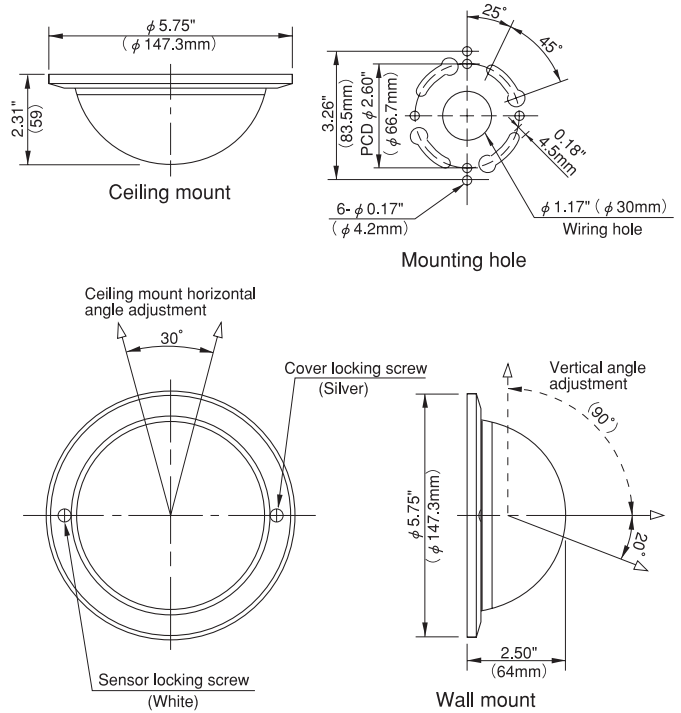

OPTIONAL

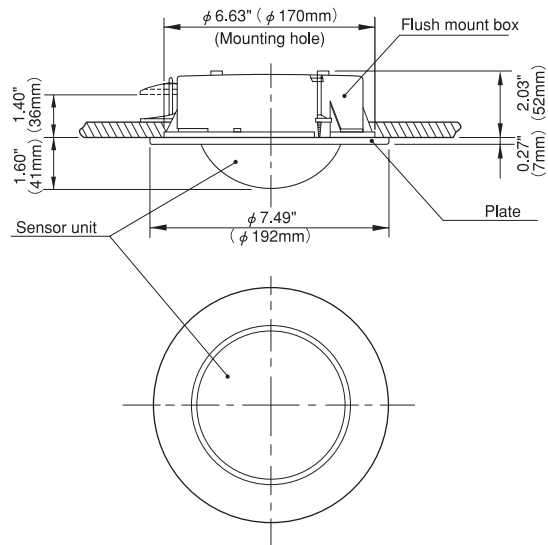

Flush mount attachment [BU-5300]

Limited Warranty :

TAKEX products are warranted to be free from defects in material and workmanship for 12 months from original date of shipment. Our warranty does not cover damage or failure caused by Acts of God, abuse misuse, abnormal usage, faulty installation, improper maintenance or any repairs other than those provided by TAKEX. All implied warranties with respect to TAKEX, including implied warranties for merchantability and implied warranties for fitness, are limited in duration to 12 months from original date of shipment. During the Warranty Period, TAKEX will repair or replace, at its sole option, free of charge, any defective parts returned prepaid. Please provide the model number of the products, original date of shipment and nature of difficulty being experienced. There will be charges rendered for product repairs made after our Warranty Period has expired.



TAKENAKA ENGINEERING CO., LTD.

In Japan

Takenaka Engineering Co., Ltd.
83-1, Gojo-sotokan, Higashino,
Yamashina-ku, Kyoto 607-8156, Japan
Tel : 81-75-501-6651
Fax : 81-75-593-3816
<http://www.takex-eng.co.jp/>

In the U.S.

Takex America Inc.
230E, Caribbean Drive
Sunnyvale, CA 94089, U.S.A.
Tel : 408-747-0100
Fax : 408-734-1100
<http://www.takex.com>

In Australia

Takex America Inc.
Unit 16, 35 Garden Road, Clayton,
Victoria 3168, Australia
Tel : 03-9546-0533
Fax : 03-9547-9450

Takex America Inc.
Brisbane office : 1/50 Logan
Road, Woolloongabba
Queensland 4102, Australia
Tel : 07-3891-3344
Fax : 07-3891-3355

In the U.K.

Takex Europe Ltd.
Pulnix House, Aviary Court, Wade Road,
Basingstoke, Hampshire. RG24 8PE, U.K.
Tel : 01256-475555
Fax : 01256-466268
<http://www.takexeuropa.com>