

# TAKEX

# FLAME SENSOR WITH SPEAKER

## FS-3000C / FS-3000E

### Instruction Manual

We appreciate your purchase of a TAKEX flame sensor. This sensor will provide long and dependable service when properly installed. Please read this Instruction Manual carefully for correct and effective use.

Please Note : This sensor is designed to detect flames and to initiate an alarm ; it is not a fire-preventing device.

TAKEX is not responsible for damage, injury or losses caused by accident, theft, Acts of God (including inductive surge by lightning), abuse, misuse, abnormal usage, faulty installation or improper maintenance.

### PRODUCT DESCRIPTION

Flame sensor FS-3000C / FS-3000E is designed to detect ultraviolet rays contained in flames, and to initiate a warning message.

This sensor can be operated for 2years with popular type-AA alkaline battery 2 pcs.

The equipped output terminal enables remote control of other warning devices, and system operation with a control panel.

Easy separation of the sensor unit and the base unit is very useful for simplifying installation and maintenance.

## 1 PARTS DESCRIPTION

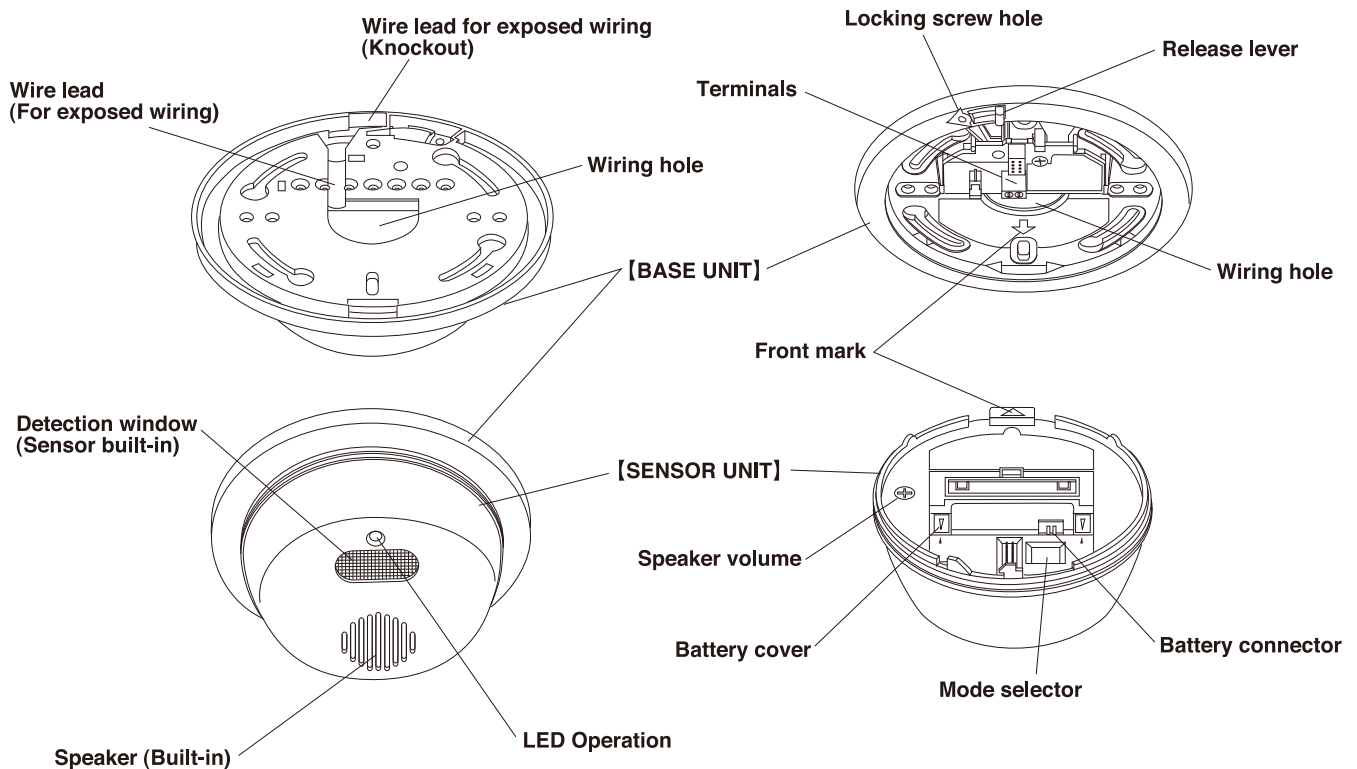

### ACCESSORY

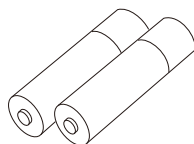

Type-AA alkaline battery  
LR-6 (2 pcs.)

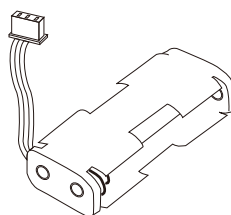

Battery case for type-AA  
(1 piece)



Sensor locking screw  
 $\phi 3 \times 6$  (1 piece)

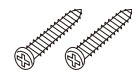

Tapping screw  
 $\phi 4 \times 25$  (2 pcs.)

# 2 ATTENTION

## Product classification

This sensor is designed to detect ultraviolet rays contained in flames, and to output a warning message.

This unit is neither fire detector nor heat detector nor smoke detector. TAKEX is not responsible for damage, injury or losses by fire, accident, calamity, Acts of God (including inductive surge by lightning), abuse, misuse, abnormal usage, faulty installation or improper maintenance.

## Others

- Intense flames such as gas explosion's may damage the sensor, and there may be no detection.



When a strong impact is given to the sensor, it may cause damage, malfunction or less performance. Do not handle in a rough manner.



## FOR SAFETY USE

- Do not use batteries other than authorized types. It may cause fire, or other damage.
- Install the battery polarity correctly according to the indication. Incorrect battery installation may cause explosion and liquid leakage that may lead to a fire.
- Do not reconstruct or resolve this unit. It may cause fire, strike by electricity.
- Do not connect equipment that exceeds the capacity indicated on the output terminal. It may cause fire.

## Objects to be detected

This sensor detects ultraviolet rays contained in flames. Therefore, this sensor may detect other sources of ultraviolet rays. This sensor does not detect burning objects which are smouldering.

Possible cause of false alarm Do not install the sensor nearby the followings.	Flames which can not be detected.
<ul style="list-style-type: none"> <li>● Halogen lamp</li> <li>● Electric discharging lamp such as mercury lamp</li> <li>● Electric sterilizer lamp</li> <li>● Spark from welding</li> <li>● Electric spark (caused by motor, pantograph)</li> <li>● Sunlight</li> <li>● Lightning discharge</li> <li>● High voltage electric field</li> <li>● All objects which emit ultraviolet rays</li> </ul>	<ul style="list-style-type: none"> <li>● Flames through glass or transparent resin</li> <li>● Lit portion of cigarette</li> <li>● Burning charcoal or briquet</li> <li>● Electric stove</li> <li>● Smouldering object</li> </ul>

# 3 DO'S AND DON'T'S

- Carefully select the installation site and set up the sensor to avoid dead spots.
- Do not install in the following places.

- Do not install in a site which is subject to direct or reflecting sunlight and rain. (This sensor is for indoor use only)

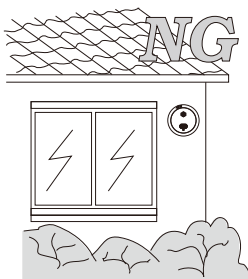

- Do not install in high humid place such as a bathroom.

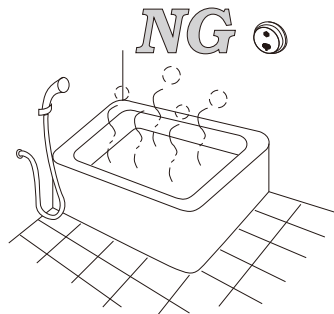

- Do not install in a site where fire (flame) is usually used such as a kitchen.

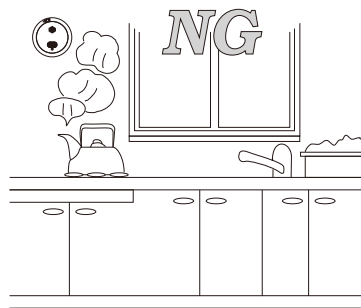

- Do not install in front of the object that intercepts light. (including glass and transparent resin etc.)

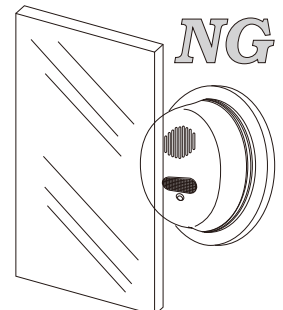

- Do not install in a site where the temperature falls to less than +14°F (-10°C) or rises more than +140°F (+60°C).
- Do not install the sensor nearby the possible cause of false alarm. (see section 2)
- **Do not give an impact to the sensor. It may cause damage, malfunction and less performance to the sensor.**
- Do not put water on the sensor, or leave the sensor in a humid place. It may cause malfunction.
- Only type-AA Alkaline battery (2 pcs.) or lithium battery 1 piece. Do not use manganese battery.

- When low battery alarm is initiated, exchange the battery immediately. If not, the sensor may not work.
- The output operation is one-shot operation. When a flame is detected longer than the detection timer set up time, it will output a warning message (approx. 4 secs./message) if the flame continues after one output ends, the output will be repeated.

# 4 WIRING

Wiring is not necessary if external output is not used.

## Terminal arrangement

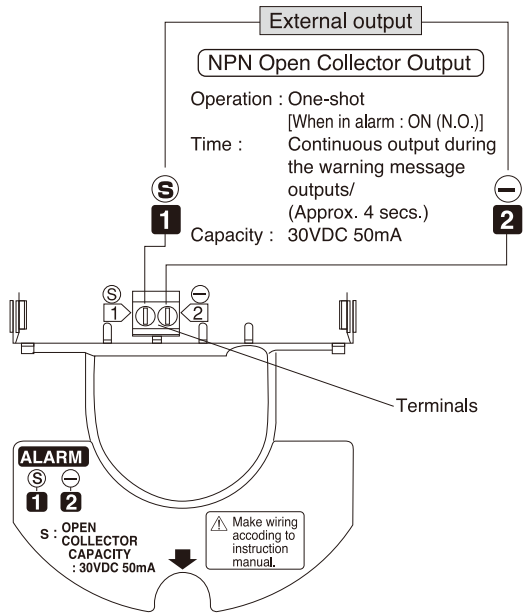

●Single wire (0.14~1.5mm<sup>2</sup>) and twisted wire (0.14~1.0mm<sup>2</sup>) can be used for the terminals.

## How to use output

### External output (Terminal ①, ②) (Open collector)

N.O. output signal for a control panel etc.  
 When more than 2 sensors are connected on 1 circuit, make the wiring in parallel.

●Example of basic connection  
 (Remote control by control panel)--- Terminal ①, ②

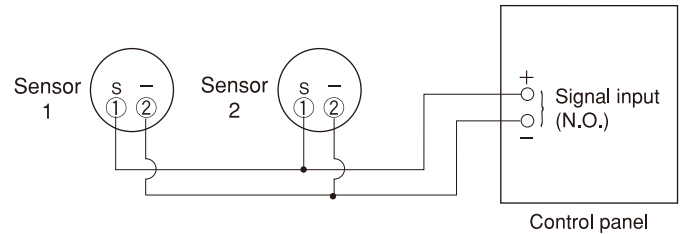

# 5 INSTALLATION

- ① Locate the installation site.  
 (Ref : 3, DO'S AND DON'T'S and 7, DETECTION AREA)
- ② Slide the release lever to detach the sensor unit.

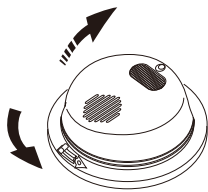

- ③ Fix the base with the screws included.  
 (Ref : Base installation described later)

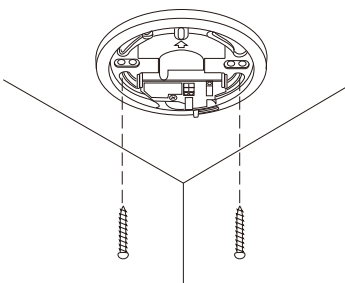

## ④ Power supply by battery.

- (1) Detach the battery cover from the back side of sensor unit with fingers.
- (2) Put Type-AA batteries into the battery case with the correct polarity.
- (3) Plug the connector of battery case into the main body and confirm the power on audible output.
- (4) Put wire first and the battery case next, into the main body.

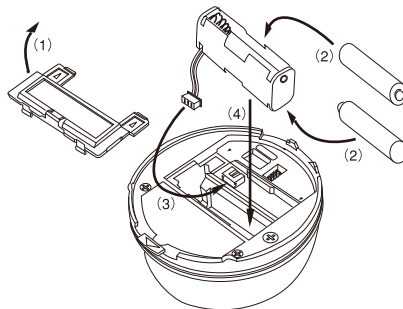

- (5) Attach the battery cover so that the marks Δ on the cover. Face the marks ▼ on the back of the sensor.

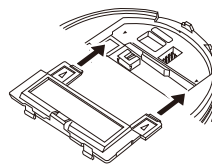

- ⑤ Choose message language, set detection timer and detection sensitivity and adjust message volume.  
 (Ref : 6-(2) Function setting)

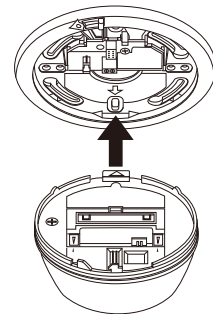

- ⑥ Attach the sensor unit to base unit.

- (1) Turn front marks of base unit and sensor unit to point in the same direction.
- (2) Insert sensor unit into base unit.
- (3) Push sensor unit until release lever is locked.

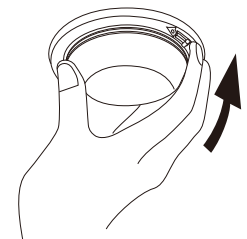

- ⑦ Check operation and area.  
 (Ref : Operation check)

- ⑧ To detach the sensor unit grip sensor as shown and slide the release lever.

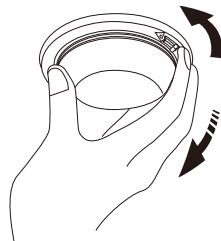

- ⑨ To lock sensor unit, insert sensor locking screw into locking screw hole and tighten it.

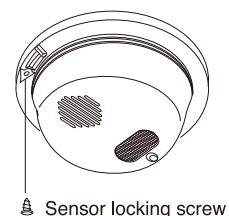

⚠ Sensor locking screw

**[Installation of base]**

● Installation hole This product is equipped with installation holes (pitch 3.29" or 83.5mm) to make installation easy and the sensor's direction adjustable.

Installation hole

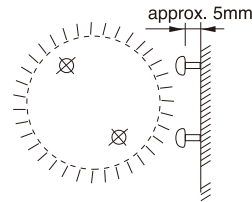
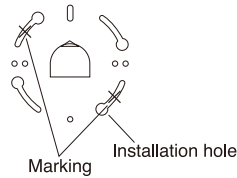

(1) Place the base on the site and mark X on 2 points 180° apart.

(2) Insert the 2 pcs. of tapping screws (accessory) leaving 5mm exposed from the surface.

(3) Adjust the sensor's direction by turning the base.

(4) Tighten the screws.

# 6 OPERATION AND FUNCTION

**(1) Operation**

**Alarm (Basic action)**

This product gives the following one-shot output only by detecting the flame continuing for the set time of detection timer.

(1 sec., 6 secs., 15 secs., 30 secs.)

Speaker : Warning message.....approx. 7 sec. / message.  
Warning sound.....10 sec. intermittent sounds.

LED : Flashes during the warning message outputs.

External output : Continuous output during the warning message outputs.

If the flame continues after the above output finishes, the output will be repeated.

**Low battery alarm**

Low battery alarm will be initiated when power is supplied from battery.

LED : Flashing every 5sec.

When low battery alarm sounds, change the battery for new one. (The sensor stops its operation 2 weeks after the low battery alarm starts.)

**Power on notice**

Power on notice will sound when the power is turned on.

[ Speaker : Sounds intermittently 3 times. ]

When voltage is low, power on notice will not be heard. Check the power supply (battery).

Within 30sec. after the power is turned off, power on notice is not issued even if the power is supplied again.

**(2) Function setting**

There are 2 functions available that can be set up according to the installed environment.

The set up can be done by the dip switch on the back of the unit.

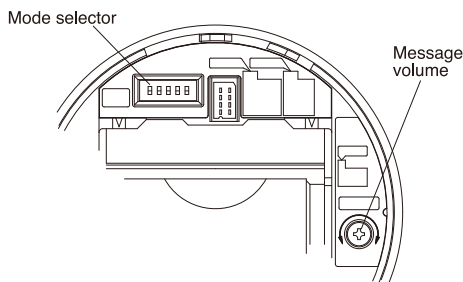

**Message language selector [1], [2]**

The warning message can be selected by the following 4 languages.

FS-3000C		
SET UP	LANGUAGE	MESSAGE
OFF ● OFF	English	"Inflammable materials in this area. No naked flames."
OFF ● ON	Chinese	"此處有可燃物，請勿明火。"
ON ● OFF	Korean	"여기는 화기엄금입니다. 즉시 불을 꺼주십시오."
ON ● ON	Turkish	"Yanıcı yer. ateşle yaklağı mayınız."

FS-3000E		
SET UP	LANGUAGE	MESSAGE
OFF ● OFF	English	"Inflammable materials in this area. No naked flames."
OFF ● ON	Spanish	"Materiales inflamables en este area. Sin llamas."
ON ● OFF	French	"Produits inflammables pas de flammes nues."
ON ● ON	Italian	"Attenzione zona a rischio incendi, non fumare e non usare fiamme libere."

**Detection sensitivity selector [3]**

Detection sensitivity is selectable H or L.

SET UP	DETECTION SENSITIVITY
ON ●	H : 100%
OFF ●	L : 50%

- ※ Detection distance on "L" setting is 50% shorter than that on "H" setting.
- ※ If the operation is unstable on "H", set the detection sensitivity "L".
- ※ When installed semi-outdoor, "L" setting is recommended.

**Detection timer selector [4], [5]**

An alarm output occurs when the flame continues for the set time of detection timer or more.

The following 4-settings are available, use the correct setting for the application.

SET UP	DETECTION TIME (Outputs when flames for more than the below time)	PURPOSE / EXAMPLE
OFF ● OFF	1 sec.	Flame of lighter / match detection at no-smoking areas.
OFF ● ON	6 sec.	Fire detection at smoking areas.
ON ● OFF	15 sec.	In case of uncertain operation on the above.
ON ● ON	30 sec.	In case of the above installations that are located near the window etc. that may be influenced by uncertain external light.

- ※ When the ultraviolet rays of a flame are weak (it is related to size of flame and distance to sensor), alarm initiation may be delayed beyond the set time.
- ※ The ultraviolet rays are not visible, and may be detected from unexpected object.
- When the sensor's operation is not stable (it detects something but not a flame) and its cause cannot be identified, set detection time longer by one step and check the performance.
- ※ When installed semi-outdoor, set detection time 6 sec. or longer.

**Ex-factory set up**

Factory default setting.

Warning message : English  
Detection sensitivity : H (100%)  
Detection timer : 1 sec.

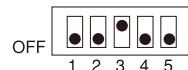

**(3) Adjustment**

**Message volume**

- ※ The message volume can be adjusted by this.
- (The volume of "Power on notice" cannot be adjusted.)

# 7 DETECTION AREA

- 1) Detection area spreads out in front of the sensor at approx. 120° conically.
- 2) The size of the detection area is in proportion to the size of the flame.  
The size of the detection area increases with an increase in flame size and duration.  
When the object of detection is from a source such as a lighter, confirm detection throughout the area.
- 3) Use the optional BCW-401 universal bracket when area adjustment is required.

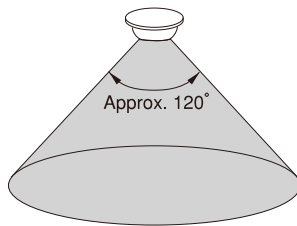

### Detection area

- Factory default setting  
Detection timer : 1 sec.  
Detection sensitivity : H (100%)  
Detection object : Gas flame of lighter [2.75" (7cm)]

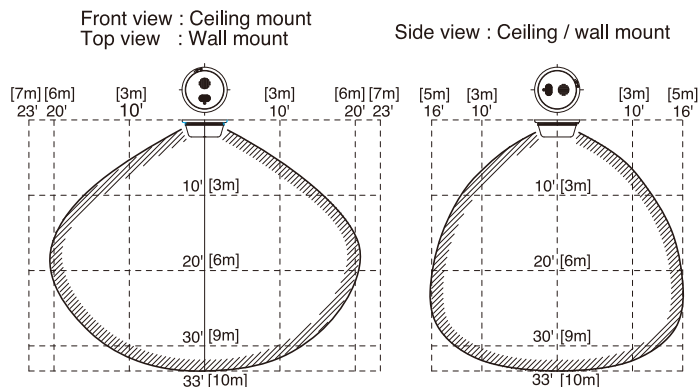

# 8 OPERATION CHECK

1. Turn power on, and confirm power on notice sounds.  
(In case of battery use, confirm power on notice when connecting the battery.)
2. Ignite a lighter etc. within detection area for more than the set time.
3. After the set time, warning message sounds intermittently and LED flashes. (Alarm action)
4. After turning off the lighter, check if the output stops at the set up time.

When external output is used by wiring, a continuous output is issued during the above 3. and 4. alarm action.  
Confirm the operation of the connected devices.



Do not use a lighter in no fire zone because it is dangerous.  
In such case, operation test have to be done in other place with sensor only.

# 9 TROUBLE SHOOTING

Solve possible problems according to the following table .  
If normal operations can not be restored by these corrective actios, contact either the dealer from whom you bought the unit or TAKEX.

Trouble	Check	Corrective action
Completely inactive	●No battery connected ●Low battery	●Connect battery ●Change battery
	●No power supply (Broken wire or improper wire) ●Low voltage (When power supply wired)	●Correct power supply or replace broken wire
	●Interrupting rays objects in front of detection area (Glass, transparent resin are interrupting rays objects)	●Remove the interrupting rays object
	●Sensor inside is wet by condensation etc.	●Dry out sensor inside, and remove the cause of the wet
Sometimes inactive	●Improper area setting	●Relocate the sensor to appropriate position ●Use a BCW-401 (optional) and adjust the angle setting
	●Detection window is soiled with dust	●Remove tha dust and soil
	●Low battery	●Change battery
	●Low voltage	●Correct power supply
Activated without flame	●Large electrical noise source such as a radio station or high-voltage wire nearby	●Relocate the sensor
	●Unexpected ultraviolet rays nearby (Ref : 2, ATTENTION)	●Remove the origin of the ultraviolet rays, interrupt ultraviolet rays, or relocate the sensor
	●Sensor inside is wet by condensation etc.	●Dry out sensor inside, and remove the cause of wet
The alarm LED flashes (5sec./once)	●Low battery (Low battery alarm)	●Change battery immediately
The alarm LED lights on but no sound from the speaker	●The volume is set up at "mute"	●Adjust the speaker volume
The alarm LED and speaker works but the connected devices are inactive (when wired)	●Poor contact output connection or broken wire	●Check the wiring or connection
	●The connected unit's trouble	●Check the connected unit

### Maintenance

- When the sensor is soiled, clean the cover with a soft cloth moistened with a small amount of cleaning solution.  
Do not use chemicals such as thinners or alcohol.
- Check operation once a week.  
Do not fail to check operation whenever a furniture in the place is moved.
- When low battery alarm sounds, change battery for new one immediately.  
If it is left, it could cause inactiveness of the sensor.

When detector elements are stained, spray alcohol to the elements and remove the stain. Do not use such chemicals as mild detergent, thinner or benzine to clean the detector elements. When housing is stained, clean it with a soft cloth.

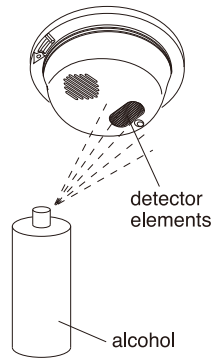

# 11 EXTERNAL DIMENSIONS

# 10 SPECIFICATIONS

Product name	FLAME SENSOR WITH SPEAKER	
Model No.	FS-3000C	FS-3000E
Detection system	Ultraviolet rays detection (Detected wave length <185 to 260nm>)	
Detection distance	33ft. (10m) [2.75" (7cm) flame]	
Detection angle	Approx. 120° (conically)	
Sensitivity adjustment	Detection timer (1 sec., 6 sec., 15 sec., 30 sec.) Detection sensitivity (H[100%], L[50%])	
Power supply	<ul style="list-style-type: none"> <li>● Type-AA alkaline battery (LR-6)×2 (3V) --- accessory</li> <li>● Exclusive lithium battery (CR17450E-R-2-CM2)×1 (3V) --- optional</li> <li>● Exclusive AC adaptor (DC-0330) (3V) --- optional</li> </ul>	
	Stand by	70 μA or less
Power consumption	Operate	300mA or less (at max. volume of speaker activating)
	Battery life	Using type-AA alkaline battery ... approx. 2 years (at stand by) Using exclusive lithium battery ... approx. 5 years (at stand by)
LED	Indication : Red LED Alarm : Flash during message output Low battery : Light on 0.1sec. every approx. 5 secs.	
Warning message output	Operation	Output warning message when detecting flames
	message selection	4 options
	*English	"Inflammable materials in this area. No naked flames."
	*Chinese	"此處嚴禁煙火 請馬上報火警"
*Korean	"여기는 화기엄금입니다 즉시 불을 꺼주십시오"	
*Turkish	"Yanıcı yer. ateşle yaklaşmayın."	
*English	"Inflammable materials in this area. No naked flames."	
*Spanish	"Materiales inflamables en este area. Sin llamas."	
*French	"Produits inflammables pas de flammes nues."	
*Italian	"Attenzione zona a rischio incendi, non fumare e non usare fiamme libere."	
Volume	Mute - max. approx. 80dB (3.3ft. <1m> from the front of speaker)	
External output	NPN open collector output 30VDC 50mA, one-shot operation ("ON" when outputting) Output time ; Same as message output time	
Wiring	External output : Terminals External power source : Plug in for optional AC adaptor	
Ambient temp. range	+14° F to +140° F (-10° C to +60° C) without condensation Battery performance may decrease under +32° F (0° C) or beyond +104° F (+40° C)	
Installation	Indoor (ceiling or wall mount)	
Weight	Approx. 8.1oz (230g) including battery (accessory) 1.8oz (50g)	
Appearance	ABS resin (white)	
Accessories	<ul style="list-style-type: none"> <li>● Tapping screw φ4×25 : 2 pcs.</li> <li>● Sensor locking screw φ3×6 : 1 piece</li> <li>● Exclusive battery case of Type-3×2 : 1 piece</li> <li>● Type-AA alkaline battery LR-6 : 2 pcs.</li> </ul>	

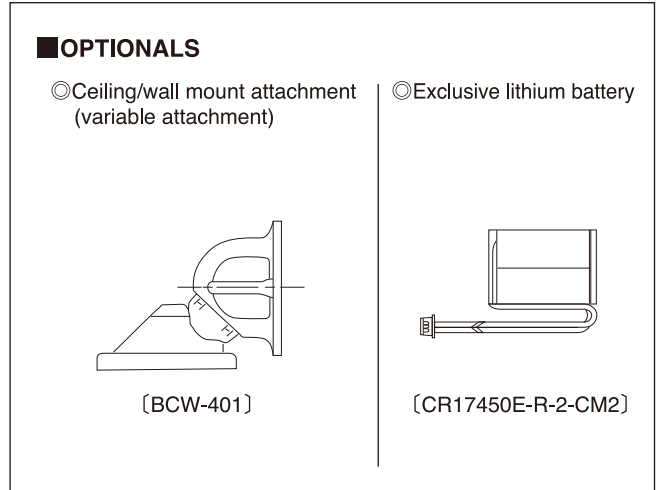
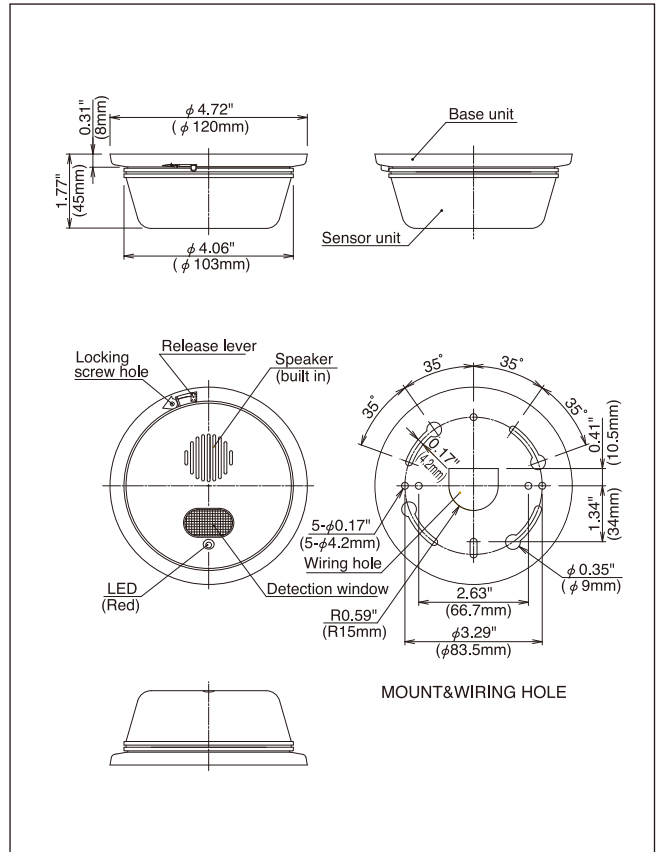

## Limited Warranty :

TAKEX products are warranted to be free from defects in material and workmanship for 12 months from original date of shipment. Our warranty does not cover damage or failure caused by Acts of God (including inductive surge by lightning), abuse, misuse, abnormal usage, faulty installation, improper maintenance or any repairs other than those provided by TAKEX. All implied warranties with respect to TAKEX, including implied warranties for merchantability and implied warranties for fitness, are limited in duration to 12 months from original date of shipment. During the Warranty Period, TAKEX will repair or replace, at its sole option, free of charge, any defective parts returned prepaid. Please provide the model number of the products, original date of shipment and nature of difficulty being experienced. There will be charges rendered for product repairs made after our Warranty period has expired.

# TAKENAKA ENGINEERING CO., LTD.

**In Japan**  
**Takenaka Engineering Co., Ltd.**  
 83-1, Gojo-sotokan, Higashino,  
 Yamashina-ku, Kyoto 607-8156, Japan  
 Tel : 81-75-501-6651  
 Fax : 81-75-593-3816  
 http : // www. takex-eng. co. jp

**In the U.S.**  
**Takex America Inc.**  
 3350 Montgomery Drive, Santa  
 Clara, CA 95054, U.S.A.  
 Tel : 408-747-0100  
 Fax : 408-734-1100  
 http : // www. takex. com

**In Australia**  
**Takex America Inc.**  
 Unit 16/35 Garden Road, Clayton,  
 3168 Victoria, Australia  
 Tel : 03-9546-0533  
 Fax : 03-9547-9450

**In the U.K.**  
**Takex Europe Ltd.**  
 Takex House, Avairy Court, Wade Road,  
 Basingstoke, Hampshire. RG24 8PE, U.K.  
 Tel : (+44) 01256-475555  
 Fax : (+44) 01256-466268  
 http : // www. takexurope. com