

NV35MR

Installation Manual V1.0

Wireless Outdoor/Indoor Dual Band
Window and Sliding Door Dual Detector
with Anti-Masking and Pet Immunity

P **▲** **R** **▲** **D** **O** **X**[™]

NV35MR-EI04



General Description NV35MR

Thank you for choosing the NV35MR Wireless for your professional protection needs. The NV35MR wireless Dual Band version will provide you the most advanced window and sliding doors protection either in Pet Immune or Sharp mode. If you have any comments please write to us at Paradox.com/products/feedback.

Pet Recommended Installation (please read)

The NV35MR has been designed to be installed within the frame of windows and doors when installed outdoors. This will ensure the best performance against false alarms when random pets such as birds, cats and small dogs access the window sill. Other installation methods can be used with the NV35MR such as wall beam protection but if installed outside of the frame its pet immunity may be compromised.

Installing the NV35MR

1. Remove the front cover - open the Captive screw.

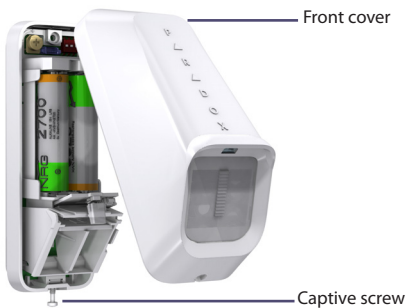

Figure 1 – Removing the Front Cover



Figure 2 – Main Unit

2. Remove the Main Unit: open the two snap-lock mechanisms on each side of the back cover attaching the Main Unit to the back cover as displayed below. Then remove the Main Unit.

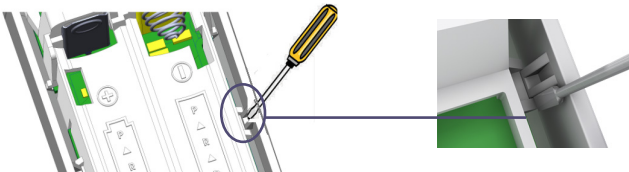

Figure 3 – Removing the Main Unit

3. Mount the back cover of the NV35MR onto the window frame or wall using screws.

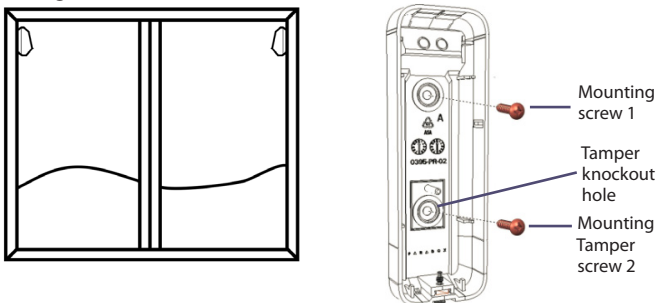

Figure 4 – Mounting the Back Cover

4. Attach the Main Unit to the back cover - ensure the locks snap closed.

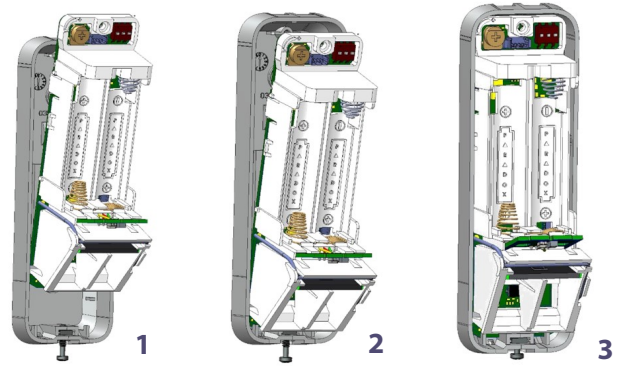
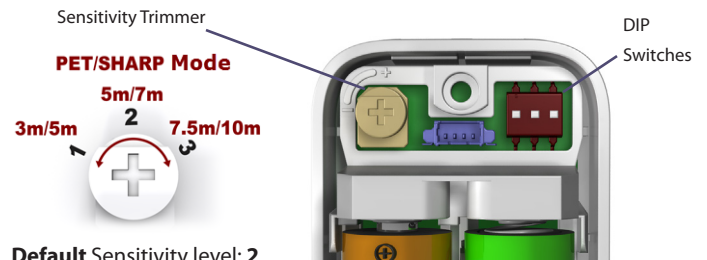

Figure 5 – Attaching the Main Unit

5. Insert two AA batteries.
6. Set the following Detector settings according to requirements.



Default Sensitivity level: 2

LED flashes green 1-3 times according to the selected level.

Figure 6 – Detector Settings

The following table displays the **Dip Switch** settings.

Table 1: DIP Switch Functionality

Dip Switch Number	Function	Mode Description
1	LED	ON: LED on (default) OFF: LED off
2	PET Immunity/ SHARP Mode	ON: PET Immunity mode (default) OFF: SHARP mode
3*	RF	ON: 433.92 MHz *(default) OFF: 868.35 MHz- applicable for EU versions only

** For USA and Canada: 433MHz frequency is set by the manufacturer and cannot be modified.*

7. Replace the front cover and close the Captive screw.

Do not obscure the detector's field of view.

Testing the NV35MR

Perform a **Walk-Test** to test successful installation: Walk slowly across the far end of the detection range and ensure detection.

Walk test mode lasts 5 minutes after the tamper screw is closed.

Beam Pattern

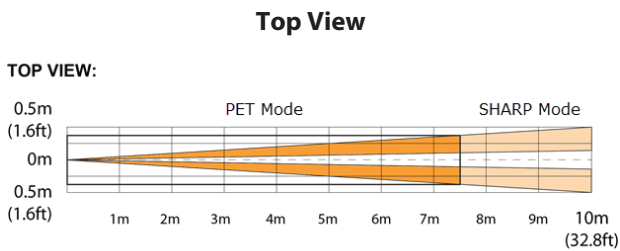
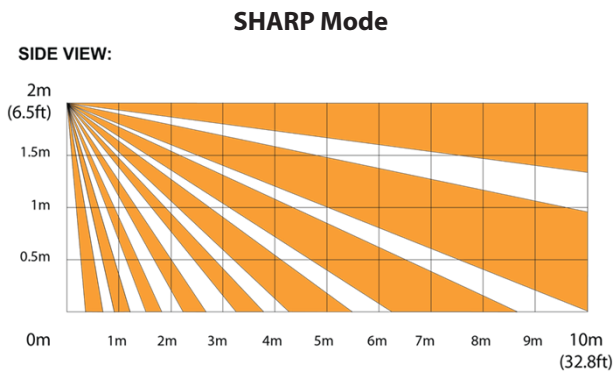
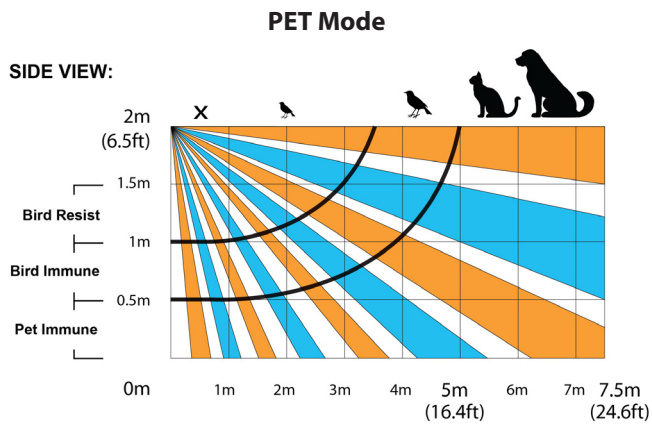

PET Immunity Mode Installation



LED Display

Feature	LED Status Indicator
Tamper open	Green: ON for 0.3 seconds every 30 seconds
PIR sensitivity level setting	Green: Flashes 1-3 times according to the selected level
Alarm detection	Red: ON for 2 seconds Power Save mode: Red blinks
Booting/Tamper close	Green/Red alternating flashes for 30 seconds
Anti-mask detection	Orange: Flashes ON/OFF 3 times every 60 seconds

Technical Specifications

Model Number	NV35MR
Infrared sensor type	2 dual elements
Detection range	<ul style="list-style-type: none"> PET Immunity mode: 7.5m x 2m (25 x 7 ft) Sharp mode: 10 x 2m (33 x 7 ft)
Super Pet Immunity	Pet size approximately 50cm
Anti- mask	Active IR detection for blocking 30cm and sprayed liquid
Input voltage	3VDC=2 x 1.5VDC AA Alkaline batteries
Current consumption	40µA in Standby 30mA in Alarm/RF Transmitting
Battery life	3 years of typical use
Low battery voltage Signal	2.5V
Compatibility	RTX3 and Magellan systems
Outdoor protection	IP54
Operation temperature	-35°C to +50°C
Relative humidity	95% non-condensing
RF Frequency	Dual Band: 433.92 MHz /868.35 MHz IMPORTANT: For US and Canada, only 433.92 MHz is used
Dimensions	12.3 x 6.1 x 4.3 cm (4.8 x 2.4 x 1.7 in.)
Weight	100g / 0.2 lb
Certifications	CE, EN50131-2-2 Grade 2, Class IV EN 50131-6 Type C Certification Body: Applica Test & Certification

ENVY™
SERIES

