



HIKVISION



Video/Audio Distributor

Quick Start Guide

UD00289B

Quick Start Guide

©2015 Hangzhou Hikvision Digital Technology Co., Ltd.

This quick start guide is intended for users of the models below:

Series	Model
Video/Audio Distributor	DS-KAD612
	DS-KAD606

It includes instructions on how to use the Product. The software embodied in the Product is governed by the user license agreement covering that Product.

About this Manual

This Manual is subject to domestic and international copyright protection. Hangzhou Hikvision Digital Technology Co., Ltd. (“Hikvision”) reserves all rights to this manual. This manual cannot be reproduced, changed, translated, or distributed, partially or wholly, by any means, without the prior written permission of Hikvision.

Trademarks

HIKVISION and other Hikvision marks are the property of Hikvision and are registered trademarks or the subject of applications for the same by Hikvision and/or its affiliates. Other trademarks mentioned in this manual are the properties of their respective owners. No right of license is given to use such trademarks without express permission.

Disclaimer

TO THE MAXIMUM EXTENT PERMITTED BY APPLICABLE LAW, HIKVISION MAKES NO WARRANTIES, EXPRESS OR IMPLIED, INCLUDING WITHOUT LIMITATION THE IMPLIED WARRANTIES OF MERCHANTABILITY AND FITNESS FOR A PARTICULAR PURPOSE, REGARDING THIS MANUAL. HIKVISION DOES NOT WARRANT, GUARANTEE, OR MAKE ANY REPRESENTATIONS REGARDING THE USE OF THE MANUAL, OR THE CORRECTNESS, ACCURACY, OR RELIABILITY OF INFORMATION CONTAINED HEREIN. YOUR USE OF THIS MANUAL AND ANY RELIANCE ON THIS MANUAL SHALL BE WHOLLY AT YOUR OWN RISK AND RESPONSIBILITY.

TO THE MAXIMUM EXTENT PERMITTED BY APPLICABLE LAW, IN NO EVENT WILL HIKVISION, ITS DIRECTORS, OFFICERS, EMPLOYEES, OR AGENTS BE LIABLE TO YOU FOR ANY SPECIAL, CONSEQUENTIAL, INCIDENTAL, OR INDIRECT DAMAGES, INCLUDING, AMONG OTHERS, DAMAGES FOR LOSS OF BUSINESS PROFITS, BUSINESS INTERRUPTION, SECURITY BREACHES, OR LOSS OF DATA OR DOCUMENTATION, IN CONNECTION WITH THE USE OF OR RELIANCE ON THIS MANUAL, EVEN IF HIKVISION HAS BEEN ADVISED OF THE POSSIBILITY OF SUCH DAMAGES.

SOME JURISDICTIONS DO NOT ALLOW THE EXCLUSION OR LIMITATION OF LIABILITY OR CERTAIN DAMAGES, SO SOME OR ALL OF THE ABOVE EXCLUSIONS OR LIMITATIONS MAY NOT APPLY TO YOU.

Support

Should you have any questions, please do not hesitate to contact your local dealer.

Regulatory Information

FCC Information

Please take attention that changes or modification not expressly approved by the party responsible for compliance could void the user's authority to operate the equipment.

FCC compliance: This equipment has been tested and found to comply with the limits for a Class B digital device, pursuant to part 15 of the FCC Rules. These limits are designed to provide reasonable protection against harmful interference in a residential installation. This equipment generates, uses and can radiate radio frequency energy and, if not installed and used in accordance with the instructions, may cause harmful interference to radio communications. However, there is no guarantee that interference will not occur in a particular installation. If this equipment does cause harmful interference to radio or television reception, which can be determined by turning the equipment off and on, the user is encouraged to try to correct the interference by one or more of the following measures:

- Reorient or relocate the receiving antenna.
- Increase the separation between the equipment and receiver.
- Connect the equipment into an outlet on a circuit different from that to which the receiver is connected.
- Consult the dealer or an experienced radio/TV technician for help.

FCC Conditions

This device complies with part 15 of the FCC Rules. Operation is subject to the following two conditions:

1. This device may not cause harmful interference.
2. This device must accept any interference received, including interference that may cause undesired operation.

EU Conformity Statement



This product and - if applicable - the supplied accessories too are marked with "CE" and comply therefore with the applicable harmonized European standards listed under the EMC Directive 2004/108/EC, the LVD Directive 2006/95/EC, the RoHS Directive 2011/65/EU.



2012/19/EU (WEEE directive): Products marked with this symbol cannot be disposed of as unsorted municipal waste in the European Union. For proper recycling, return this product to your local supplier upon the purchase of equivalent new equipment, or dispose of it at designated collection points. For more information see: www.recyclethis.info



2006/66/EC (battery directive): This product contains a battery that cannot be disposed of as unsorted municipal waste in the European Union. See the product documentation for specific battery information. The battery is marked with this symbol, which may include lettering to indicate cadmium (Cd), lead (Pb), or mercury (Hg). For proper recycling, return the battery to your supplier or to a designated collection point. For more information see: www.recyclethis.info

Industry Canada ICES-003 Compliance

This device meets the CAN ICES-3 (B)/NMB-3(B) standards requirements.



Safety Instruction

These instructions are intended to ensure that user can use the product correctly to avoid danger or property loss.

The precaution measure is divided into **Warnings** and **Cautions**:

Warnings: Neglecting any of the warnings may cause serious injury or death.

Cautions: Neglecting any of the cautions may cause injury or equipment damage.

	
Warnings Follow these safeguards to prevent serious injury or death.	Cautions Follow these precautions to prevent potential injury or material damage.



Warnings

All the electronic operation should be strictly compliance with the electrical safety regulations, fire prevention regulations and other related regulations in your local region.

Please use the power adapter, which is provided by normal company. The power consumption cannot be less than the required value.

Do not connect several devices to one power adapter as adapter overload may cause over-heat or fire hazard.

Please make sure that the power has been disconnected before you wire, install or dismantle the device.

When the product is installed on wall or ceiling, the device shall be firmly fixed.

If smoke, odors or noise rise from the device, turn off the power at once and unplug the power cable, and then please contact the service center.

If the product does not work properly, please contact your dealer or the nearest service center. Never attempt to disassemble the device yourself. (We shall not assume any responsibility for problems caused by unauthorized repair or maintenance.)



Cautions

Do not drop the device or subject it to physical shock, and do not expose it to high electromagnetic radiation. Avoid the equipment installation on vibrations surface or places subject to shock (ignorance can cause equipment damage).

Do not place the device in extremely hot (refer to the specification of the device for the detailed operating temperature), cold, dusty or damp locations, and do not expose it to high electromagnetic radiation.

The device cover for indoor use shall be kept from rain and moisture.

Exposing the equipment to direct sun light, low ventilation or heat source such as heater or radiator is forbidden (ignorance can cause fire danger).

Do not aim the device at the sun or extra bright places. A blooming or smear may occur otherwise (which is not a malfunction however), and affecting the endurance of sensor at the same time.

Please use the provided glove when open up the device cover, avoid direct contact with the device cover, because the acidic sweat of the fingers may erode the surface coating of the device cover.

Please use a soft and dry cloth when clean inside and outside surfaces of the device cover, do not use alkaline detergents.

Please keep all wrappers after unpack them for future use. In case of any failure occurred, you need to return the device to the factory with the original wrapper. Transportation without the original wrapper may result in damage on the device and lead to additional costs.

Improper use or replacement of the battery may result in hazard of explosion. Replace with the same or equivalent type only. Dispose of used batteries according to the instructions provided by the battery manufacturer.

Table of Contents

1 Overview	1
1.1 Introduction.....	1
1.2 Main Features.....	1
2 Appearance	2
2.1 Appearance of DS-KAD606	2
2.2 Appearance of DS-KAD612	2
3 Interfaces Description	4
3.1 Interfaces of DS-KAD606.....	4
3.2 Interfaces of DS-KAD612.....	4
4 Typical Application	6
5 Installation (Wall Mounting)	7
Appendix	8
Specification of DS-KAD606.....	8
Specification of DS-KAD612.....	8

1 Overview

1.1 Introduction

The video/audio distributor supports network cable power supply, and has a built-in voltage-stabilized power. DS-KAD606 has eight 10/100M LAN interfaces, six of which support powering over network cables, and DS-KAD612 has sixteen 10M/100M LAN interfaces, twelve of which support powering over network cables. The video/audio distributor is suitable for internet connection of all-digital video intercom in residence communities.

1.2 Main Features

- Built-in DC 24V voltage-stabilized switching mode power supply
- Sixteen RJ-45 interfaces, including twelve adaptive 10M/100M LAN interfaces supporting network cable powering and four adaptive 10M/100M cascading LAN interfaces (DS-KAD612)
- Eight RJ-45 interfaces, including six adaptive 10/100M LAN interfaces supporting network cable powering and two adaptive 10/100M cascading LAN interfaces (DS-KAD606)
- IEEE802.3, IEEE802.3u, IEEE802.3x
- Storing and forwarding function
- VLAN technique
- Over 1,000,000 h mean time between failure
- Operating temperature range: from -30° C to 70° C
- Suitable for wall mounting (optional)

2 Appearance

2.1 Appearance of DS-KAD606

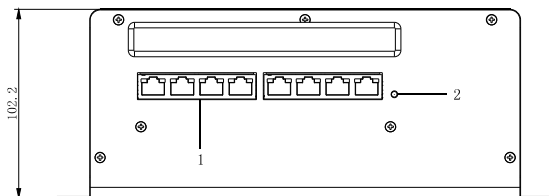

Figure 2-1 Front Panel

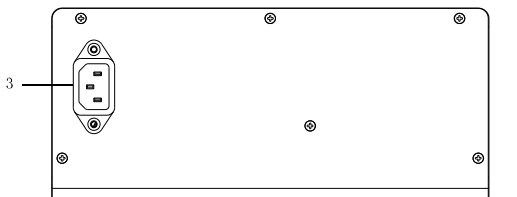

Figure 2-2 Rear Panel

Table 2-1 Description

No.	Description
1	8 RJ-45 interfaces
2	Power Indicator
3	AC 220V, Power Socket

2.2 Appearance of DS-KAD612

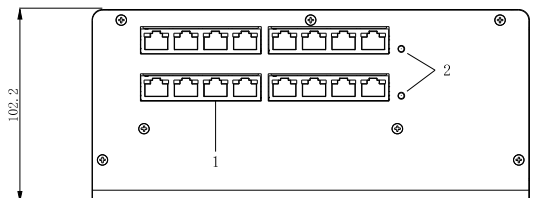

Figure 2-3 Front Panel

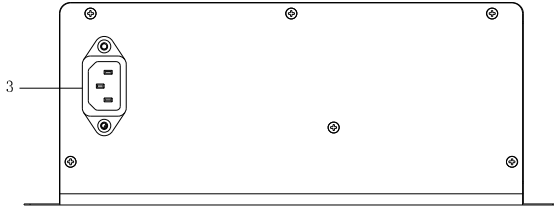

Figure 2-4 Rear Panel

Table 2-2 Description

No.	Description
1	16 RJ-45 interfaces
2	Power Indicators
3	AC 220V, Power Socket

3 Interfaces Description

3.1 Interfaces of DS-KAD606

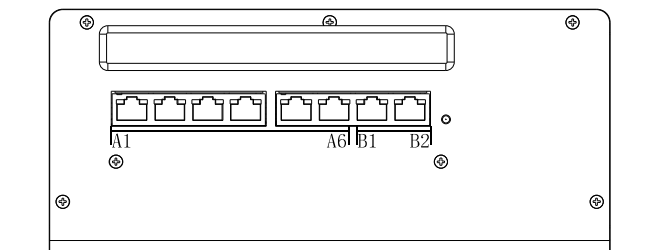

Figure 3-1 Interface of KAD606

Interfaces B1 and B2 can be connected to a distributor with a network cable. Interfaces A1, A2, A3, A4, A5, and A6 are device interfaces. Only the Hikvision video intercom devices supporting Power over Network Cable can be connected to device interfaces.

Only when interface B1 or B2 is connected to a distributor with a network cable, can device interfaces connect to the network normally.



- Do not connect any device interfaces (A1, A2, A3, A4, A5, or A6) to a distributor.
- Device interfaces (A1, A2, A3, A4, A5, and A6) cannot be interconnected directly.

3.2 Interfaces of DS-KAD612

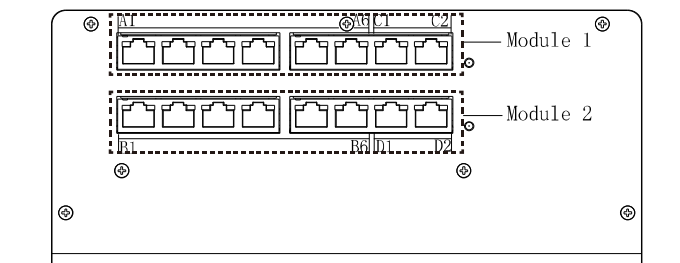

Figure 3-2 Interfaces of KAD612

Interfaces C1, C2, D1, and D2 can be connected to a distributor with a network cable. Interfaces A1, A2, A3, A4, A5, A6, B1, B2, B3, B4, B5, and B6 are device interfaces. Only the Hikvision video intercom devices supporting Power over Network Cable can be connected to device interfaces.

Both module 1 and module 2 are independent modules. When interface C1 or C2 is connected to a distributor with a network cable, only devices connected to interfaces on the module 1 can connect to the network normally. When interface D1 or D2 is connected to a distributor with a network cable, only devices connected to interfaces on the module 2 can connect to the network normally.

If you want to use module 1 and module 2 simultaneously, you can connect interface C2 or D2 to a distributor, and directly connect interface C1 with D1 with a network cable.



- Do not connect any device interfaces (A1, A2, A3, A4, A5, A6, B1, B2, B3, B4, B5, or B6) to a distributor.
- Device interfaces (A1, A2, A3, A4, A5, A6, B1, B2, B3, B4, B5, and B6) cannot be interconnected directly.

4 Typical Application

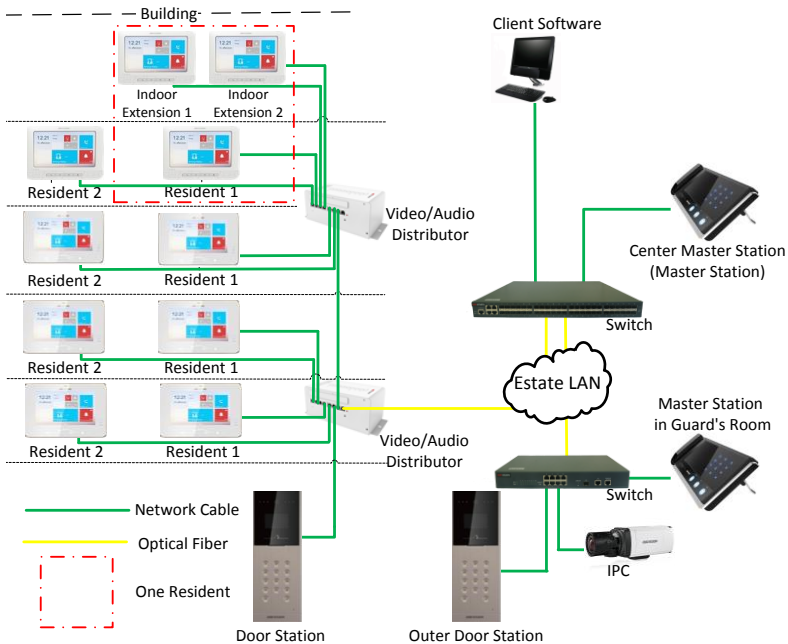

Figure 4-1 Typical Application of Video/Audio Distributor



Indoor extensions in a resident are in the same LAN with other devices in a video intercom system.

5 Installation (Wall Mounting)



- The video/audio distributor can be put on the desk or be installed onto the wall.
- Here we take the installation of DS-KAD612 as example.

Please refer to the bottom panel of the video/audio distributor.

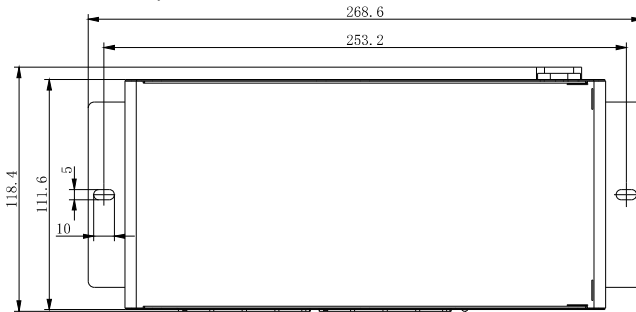

Figure 5-1 Dimensions of Bottom Panel

Steps:

1. Take the video/audio distributor and screws from the packing box.
2. Attach the bottom panel of the distributor to the wall.

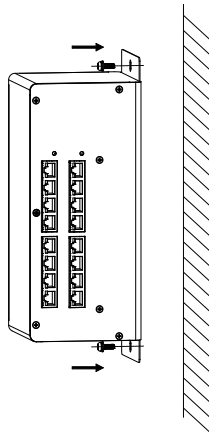

Figure 5-2 Install the Video/Audio Distributor

3. Insert 2 expansion screws into the screw holes to fix the distributor onto the wall.

Appendix

Specification of DS-KAD606

Model	DS-KAD606
Parameters	
Network Parameters	
Interface Number	Sixteen 10M/100M Interfaces
Interface Type	RJ-45, Full/Half-Duplex, MDI/MDI-X Self-Adaptive
Standard	IEEE802.3, IEEE802.3u, IEEE802.3x
Processing Type	Storing and Forwarding
Flow Control	IEEE802.3x (Full-Duplex), Back Pressure (Half-Duplex)
Priority Queue	Four
MAC Address List	8K
Internal Buffer	1 Mbit
Other Parameters	
Power Supply	AC 220V
Power Consumption	<3 W
Working Temperature	-30° C to 70° C (-22° F to 158° F)
Working Humidity	5% to 95%, No Condensation
Dimension (L x W x H)	275.2 mm x 92 mm x 102.2 mm (10.8" x 3.6" x 4.0")
Certification	FCC, IC, CE, C-TICK, ROHS, REACH, WEEE

Specification of DS-KAD612

Model	DS-KAD612
Parameters	
Network Parameters	
Interface Number	Sixteen 10M/100M Interfaces
Interface Type	RJ-45, Full/Half-Duplex, MDI/MDI-X Self-Adaptive
Standard	IEEE802.3, IEEE802.3u, IEEE802.3x
Processing Type	Storing and Forwarding

Video/Audio Distributor • Quick Start Guide

Flow Control	IEEE802.3x (Full-Duplex), Back Pressure (Half-Duplex)
Priority Queue	Four
MAC Address List	8K
Internal Buffer	1 Mbit
Other Parameters	
Power Supply	AC 220V
Power Consumption	<6 W
Working Temperature	-30° C to 70° C (-22° F to 158° F)
Working Humidity	5% to 95%, No Condensation
Dimension (L x W x H)	275.2 mm x 92 mm x 102.2 mm (10.8" x 3.6" x 4.0")
Certification	FCC, IC, CE, C-TICK, ROHS, REACH, WEEE



First Choice for Security Professionals