



Alarm Hub

User's Manual







Foreword

General

This manual introduces the installation, functions and operations of the alarm hub (hereinafter referred to as the "hub"). Read carefully before using the device, and keep the manual safe for future reference.

Safety Instructions

The following signal words might appear in the manual.

Signal Words	Meaning
 DANGER	Indicates a high potential hazard which, if not avoided, will result in death or serious injury.
 WARNING	Indicates a medium or low potential hazard which, if not avoided, could result in slight or moderate injury.
 CAUTION	Indicates a potential risk which, if not avoided, could result in property damage, data loss, lower performance, or unpredictable result.
 TIPS	Provides methods to help you solve a problem or save you time.
 NOTE	Provides additional information as the emphasis and supplement to the text.

Revision History

Version	Revision Content	Release Time
V2.0.0	<ul style="list-style-type: none"> Added network configurations. Added arming failure events and descriptions. Added SIA event codes and descriptions. 	November 2022
V1.1.0	<ul style="list-style-type: none"> Added operations on COS Pro and DMSS app. Added user management. Updated images. Updated descriptions of parameters. 	February 2022
V1.0.0	First release.	October 2021

Privacy Protection Notice

As the device user or data controller, you might collect the personal data of others such as their face, fingerprints, and license plate number. You need to be in compliance with your local privacy protection laws and regulations to protect the legitimate rights and interests of other people by implementing measures which include but are not limited: Providing clear and visible identification to inform people of the existence of the surveillance area and provide required contact information.

About the Manual

- The manual is for reference only. Slight differences might be found between the manual and the product.
- We are not liable for losses incurred due to operating the product in ways that are not in compliance with the manual.
- The manual will be updated according to the latest laws and regulations of related jurisdictions. For detailed information, see the paper user's manual, use our CD-ROM, scan the QR code or visit our official website. The manual is for reference only. Slight differences might be found between the electronic version and the paper version.
- All designs and software are subject to change without prior written notice. Product updates might result in some differences appearing between the actual product and the manual. Please contact customer service for the latest program and supplementary documentation.
- There might be errors in the print or deviations in the description of the functions, operations and technical data. If there is any doubt or dispute, we reserve the right of final explanation.
- Upgrade the reader software or try other mainstream reader software if the manual (in PDF format) cannot be opened.
- All trademarks, registered trademarks and company names in the manual are properties of their respective owners.
- Please visit our website, contact the supplier or customer service if any problems occur while using the device.
- If there is any uncertainty or controversy, we reserve the right of final explanation.

Important Safeguards and Warnings

This section introduces content covering the proper handling of the device, hazard prevention, and prevention of property damage. Read carefully before using the device, and comply with the guidelines when using it.

Operation Requirements



- Make sure that the power supply of the device works properly before use.
- Do not pull out the power cable of the device while it is powered on.
- Only use the device within the rated power range.
- Transport, use and store the device under allowed humidity and temperature conditions.
- Prevent liquids from splashing or dripping on the device. Make sure that there are no objects filled with liquid on top of the device to avoid liquids flowing into it.
- Do not disassemble the device.

Installation Requirements



WARNING

- Connect the device to the adapter before power on.
- Strictly abide by local electrical safety standards, and make sure that the voltage in the area is steady and conforms to the power requirements of the device.
- Do not connect the device to more than one power supply. Otherwise, the device might become damaged.



- Observe all safety procedures and wear required protective equipment provided for your use while working at heights.
- Do not expose the device to direct sunlight or heat sources.
- Do not install the device in humid, dusty or smoky places.
- Install the device in a well-ventilated place, and do not block the ventilator of the device.
- Use the power adapter or case power supply provided by the device manufacturer.
- The power supply must conform to the requirements of ES1 in IEC 62368-1 standard and be no higher than PS2. Note that the power supply requirements are subject to the device label.
- Connect class I electrical appliances to a power socket with protective earthing.

Table of Contents

Foreword	I
Important Safeguards and Warnings.....	III
1 Introduction	1
1.1 Overview	1
1.2 Technical Specifications.....	1
1.3 Checklist.....	5
2 Design.....	7
2.1 Appearance.....	7
2.2 Dimensions	8
3 Startup	9
3.1 Users.....	9
3.2 Operation Process	10
4 COS Pro Operations for Installers.....	13
4.1 Logging in to COS Pro.....	13
4.2 Adding Devices	14
4.2.1 Adding the Hub.....	14
4.2.1.1 Adding by SN/QR Code	14
4.2.1.2 Adding through AP Configuration.....	15
4.2.1.3 Adding by LAN Searching.....	17
4.2.2 Adding Accessories.....	18
4.3 Managing Users.....	19
4.3.1 Adding DMSS Admin Users.....	19
4.3.1.1 Lending the Device to the DMSS Admin Users	19
4.3.1.2 Accepting Entrusting Requests	20
4.3.2 Deleting Users	22
4.3.2.1 Cancelling to Lend the Devices.....	22
4.3.2.2 Deleting Devices.....	23
4.4 Applying for DMSS Admin User's Permission.....	23
4.5 Delivering Devices to DMSS Admin User.....	24
4.6 Operation and Device Health Maintenance	24
4.6.1 Checking Device Health Status.....	25
4.6.2 Device Basic Configurations.....	25
4.6.2.1 Viewing Status.....	26
4.6.2.2 Configuring the Hub.....	27
4.6.3 Fixing Errors	29

4.6.4 Viewing Evaluations.....	30
5 DMSS Operations for End Users	31
5.1 Logging in to DMSS	31
5.2 Adding Devices	32
5.2.1 Adding the Hub.....	32
5.2.2 Adding Accessories.....	33
5.3 Hub General Settings.....	33
5.3.1 Hub Configuration	33
5.3.2 Network Configuration.....	33
5.3.2.1 Wired Network Configuration.....	33
5.3.2.2 Wi-Fi Network Configuration.....	33
5.3.2.3 Cellular Configuration.....	34
5.4 Managing Users.....	34
5.4.1 Adding Users.....	34
5.4.1.1 Adding DMSS General Users	34
5.4.1.2 Adding Installers	35
5.4.1.2.1 Entrusting Device One by One	35
5.4.1.2.2 Entrusting Devices in Batches	36
5.4.2 Deleting Users	37
5.4.2.1 Cancelling to Share the Devices	37
5.4.2.2 Cancelling Entrusting Application	37
5.4.2.3 Deleting Devices.....	38
6 General Operations	39
6.1 Single Arming and Disarming	39
6.2 Global Arming and Disarming.....	40
6.3 Manual Arming and Disarming.....	40
6.4 Scheduled Arming and Disarming	40
Appendix 1 Arming Failure Events and Description	41
Appendix 2 SIA Event Codes and Description	43
Appendix 3 Cybersecurity Recommendations	46

1 Introduction



1.1 Overview

Alarm hub is a central device in the security system, which controls the operation of all connected accessories. If the security system detects the presence, entry, or attempted entry of an intruder into the armed area, the hub will receive the alarm signals from the detectors, and then alert users.

1.2 Technical Specifications

This section contains technical specifications of the device. Please refer to the ones that correspond with your model.

Table 1-1 Technical specifications

Type	Parameter	Description
Port	Network	1 RJ-45 10 M/100 M self-adaptive Ethernet port
	GSM	Single SIM (GSM:900/1800 MHz); dual SIM single standby
	LTE	Single SIM (GSM: 900/1800 MHz, WCDMA: B1/B5/B8, LTE-FDD: B1/B3/B5/B7/B8/B20, LTE-TDD:B38/B40/B41); dual SIM single standby
	Battery	12 V battery port
	Indicator Light	1 for multiple statuses (alarm, arming, disarming, networking, and malfunction)
	Button	1 × reset, 1 × power, 1 × AP
	Buzzer	Built-in
	Tamper	1 case tamper port for the alarm control panel
Function	SMS Notification	SMS alarm (up to 5 phone numbers)  Only available on select models.
	Phone Call Notification	Yes (up to 5 phone numbers)  Only available on select models.
	Video Linkage	Yes
	Network Protocol	TCP/IP, including PPTP, L2TP, DHCP, UPNP, and NTP
	Remote Upgrade	Cloud update
	Configuration Method	App
	Arm and Disarm Method	App, keypad, keyfob, schedule

Type	Parameter	Description	
	Number of Peripherals	Max. 150-channel wireless peripherals (6 sirens, 64 wireless keyfobs, 4 repeaters, and 8 keypads)	
	Area	32 areas (rooms)	
	Power Management	Automatic switching between main power supply and storage power supply	
		Alarm for main power loss	
		Alarm for battery loss and battery voltage fault	
	Event Logs	Max. 400	
	Power Failure Protection for Configured Parameters	Yes	
	User Management	Max. 8 users: 1 installer, 1 administrator, 6 general users	
Query	Searching for push messages, device status, and program version. Detecting signal strength.		
RF	Carrier Frequency	DHI-ARA3000H-FW2 (868)/DHI-ARA3000H-GW2 (868)/DHI-ARA3000H-W2 (868): 868.0 MHz–868.6 MHz	DHI-ARA3000H-FW2/DHI-ARA3000H-GW2/DHI-ARA3000H-W2: 433.1 MHz–434.6 MHz
	Communication Distance	DHI-ARA3000H-FW2 (868)/DHI-ARA3000H-GW2 (868)/DHI-ARA3000H-W2 (868): Up to 2,000 m (6,561.68 ft) in an open space	DHI-ARA3000H-FW2/DHI-ARA3000H-GW2/DHI-ARA3000H-W2: Up to 1,200 m (3,937.01 ft) in an open space
	Transmission Power	DHI-ARA3000H-FW2 (868)/DHI-ARA3000H-GW2 (868)/DHI-ARA3000H-W2 (868): Limit 25 mW	DHI-ARA3000H-FW2/DHI-ARA3000H-GW2/DHI-ARA3000H-W2: Limit 10 mW
	Communication Mechanism	Two-way	
	Encryption Mode	AES128	
	Frequency Hopping	Yes	
	RF Interference Detection	For a 60-second detection, if the interference lasts longer than 30 seconds, the system reports the RF interference information.	
	Wi-Fi	2.4 G	
Power Supply	PS Type	Type A	
	Main Power	12 VDC, 1.5 A	
	Battery Capacity	2x 3.6 V/2150 mAh	

Type	Parameter	Description
	Battery Standby	Up to 12 h  When following conditions are met, the standby time can reach 12 h: <ul style="list-style-type: none"> • Connects with Wi-Fi, GPRS/3G/4G. • Connects to ARC and heartbeat interval is 1800 seconds. • Connects to 8 inputs and 1 siren. • Connects to the cloud.
	Battery Type	Battery type: Built-in rechargeable Lithium-ion polymer; battery model: 18650
	Max. current available	3.5 A
	Power Consumption	Max. 15 W
	Current Consumption	Normal: 220 mA; alarm: 300 mA
	Battery Low Battery Threshold	3.5 VDC
	Battery Restore Threshold	3.7 VDC
	Release Voltage	< 3.358 V
	Battery Recharge Time	80% approx. 15 h
ARC Signaling	ATS Category	DP2/SP2 (LAN/Wi-Fi and GPRS/4G)
	Acknowledgement Operation	Pass through
	Protocols	SIA-DC09
	Primary Transmission Path	LAN /Wi-Fi (NO 50136-2)
	Secondary Transmission Path	GPRS/4G
	Notification Equipment	C/E/F

Type	Parameter	Description	
Certifications		DHI-ARA3000H-FW2 (868)/DHI-ARA3000H-GW2 (868)/DHI-ARA3000H-W2 (868): EN 50131-1:2006+A1:2009+A2:2017+A3:2020 EN 50131-3:2009 EN 50131-6:2017 EN 50131-5-3:2017 EN 50131-10: 2014 EN 50136-2: 2013 Security Grade 2 Environmental Class II CE	DHI-ARA3000H-FW2/DHI-ARA3000H-GW2/DHI-ARA3000H-W2: FCC CE

Table 1-2 ATE category

ATE Category	Reporting Time	Protocols	Communication Devices			Communication Device to be Used
			PSTN	2G/3G	IP	
SP2	25 h	Standard	√			The check marked communication device
SP3	30 min	Standard		√	√	Only one of the two check marked communication devices
SP4	3 min	Encrypted		√	√	Only one of the two check marked communication devices
SP5	90 s	Encrypted		√	√	Only one of the two check marked communication devices
DP1	25 h	Standard	√	√	√	Only two of the three check marked communication devices
DP2	30 min	Standard	√	√	√	Only two of the three check marked communication devices
DP3	3 min	Encrypted		√	√	The two check marked communication devices

ATE Category	Reporting Time	Protocols	Communication Devices			Communication Device to be Used
			PSTN	2G/3G	IP	
DP4	90 s	Encrypted		√	√	The two check marked communication devices

ATE: Alarm transmission equipment.

SPx (Single Path): A value that indicates the performance level achieved by a single communication device, according to the EN 50136-1 standard.

DPx (Double Path): A value that indicates the performance level achieved by a combination of two communication devices, according to the EN 50136-1 standard.

Reporting time: The reporting time is prescribed based on the standard of each level of performance. Reporting time is the maximum time available to report when an alarm transmission device fails. Alarm transmission devices meet this requirement by regularly reporting their status through a specific symbolic test function.

Protocols: Indicates the security level of the protocols to be used for the notification of failures. Standard protocols and voice protocols are encrypted. High security protocols are encrypted with an AES 128 bit or AES 256 bit encryption key.

Communication devices: Implemented communication devices.

Communication devices to be used: Indicates the number of and which communication devices are to be used based on the ATE category.

Table 1-3 Technical specification

Technical Specification	Description
ACE Classification	Type A
Environmental Class	II
Supply Voltage	12 VDC, 1.5 A
Product Dimensions	163.0 mm× 163.0 mm× 32.0 mm (6.42" × 6.42" × 1.26")
Packaging Dimensions	219.0 mm× 187.0 mm× 91.0 mm (8.62" × 7.36" × 3.58")
Operating Temperature	-10 °C to +50 °C (+14 °F to +122 °F) -10 °C to +40 °C (+14 °F to 104 °F) (Certified temperature)
Humidity	10%–90% (RH)
Net Weight	0.38 kg (0.84 lb)
Gross Weight	0.8 kg (1.76 lb)
Casing	PC + ABS

1.3 Checklist

Check the package according to the following checklist. If you find anything damaged or lost,

contact customer service.

Figure 1-1 Checklist

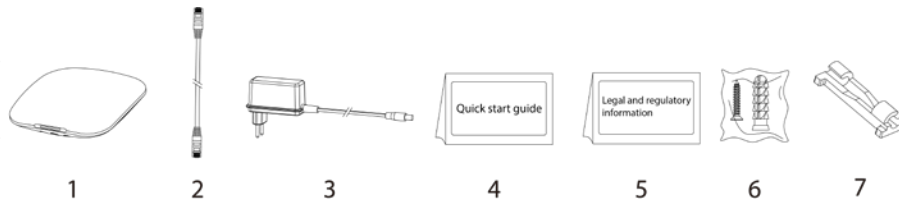

Table 1-4 Checklist

No.	Item Name	Quantity	No.	Item Name	Quantity
1	Alarm hub	1	5	Legal and regulatory information	1
2	Cable	1	6	Screw package	1
3	Adapter	1	7	Wire fixing clamp clip	1
4	Quick start guide	1	—	—	—

2 Design

2.1 Appearance

Figure 2-1 Appearance

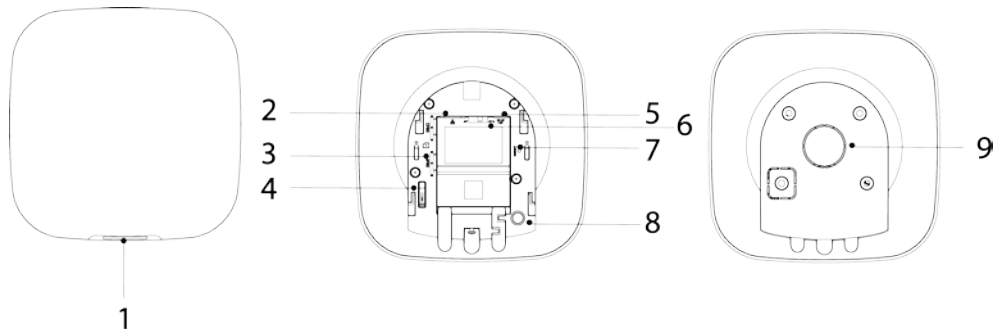



Table 2-1 Structure

No.	Name	Description
1	Indicator	<ul style="list-style-type: none"> Flashes green slowly: Reduced sensitivity mode. Flashes green: The hub starts working. Solid yellow: Failed to connect to the cloud. Solid green: Disarming mode. Solid blue: Arming mode. Flashes red: Alarm event was triggered. Flashes yellow: Detected a malfunction. Flashes blue: Running AP configuration or the hub is pairing with peripherals. Flashes blue quickly: Card issuing mode.
2	Ethernet cable socket	Connect the hub to the Ethernet.
3	Slot for micro SIM 1/2	Install main card to the first slot, and standby card to the second slot. <ul style="list-style-type: none"> Support dual SIM cards and single standby. SIM cards allow the hub to use cellular data, and push alarm notifications.  <ul style="list-style-type: none"> SIM cards will not work until network configuration has been completed. SIM function is only available on select models.
4	Tamper button	When the tamper switch is released, the tamper alarm will be triggered.
5	Power cable socket	Insert power cable.
6	AP	Turn on AP, the phone will connect to the hotspot from the hub, and then sync Wi-Fi username and password to the hub.

No.	Name	Description
7	Reset button	Press and hold the button for 10 seconds to restart the hub and restore factory default settings.
8	On/off button	Press and hold the button for 2 seconds to turn on or turn off the hub.
9	Back cover	If the back cover is opened, the tamper alarm will be triggered.

2.2 Dimensions

Figure 2-2 Dimensions (Unit: mm [inch])

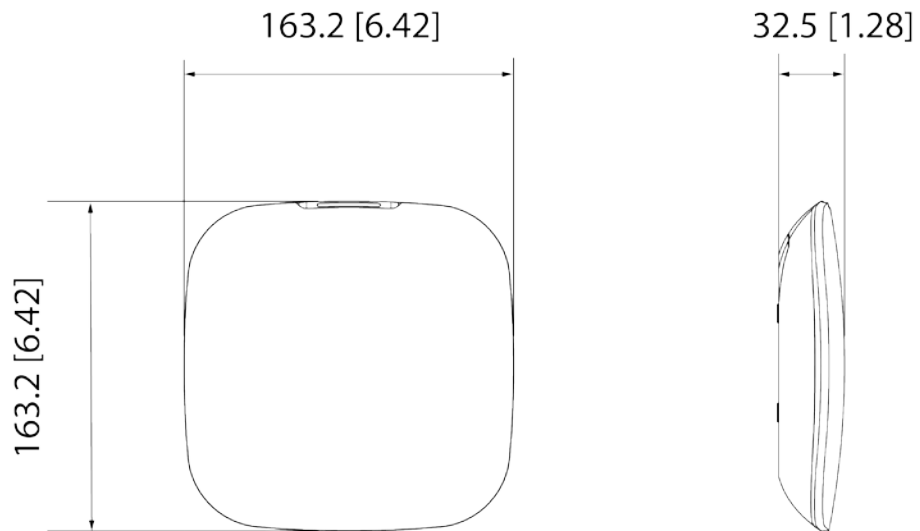

3 Startup

3.1 Users

Users can only be created on the DMSS and COS Pro app. Classify the users into different roles so that they can have different access levels for operating the devices.

User Access Level

Table 3-1 User access level

User	Access Level
DMSS admin user	L2
DMSS general user	L2
Installer	L3

- **Installer:** Installers provide end users with operation and maintenance services. This role has to apply for permissions from the end user (DMSS admin user) to operate the device. They can receive permissions such as device configuration and user management.
- **DMSS admin user:** The administrator user would be an end user. This role cannot be modified and has permissions, such as device configuration and user management. The DMSS admin users does not have permission to configure the device when installers lend the hub to them, or when they entrust the hub to the installer.
- **DMSS general user:** These are users who a DMSS admin user shares devices with through the DMSS app. This role can be modified and only has basic permissions, such as viewing device status, and arming and disarming rooms.

Business Flow

Following is the entrusting and sharing process on the DMSS and COS Pro app. Installers and end users can follow the process to share and entrust devices.

Figure 3-1 Business flow (DMSS user)

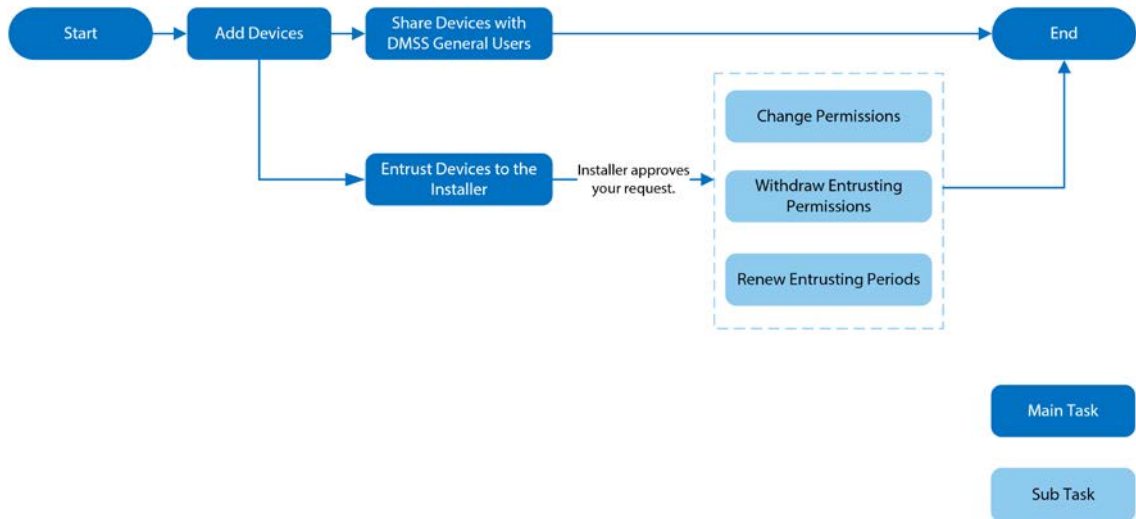
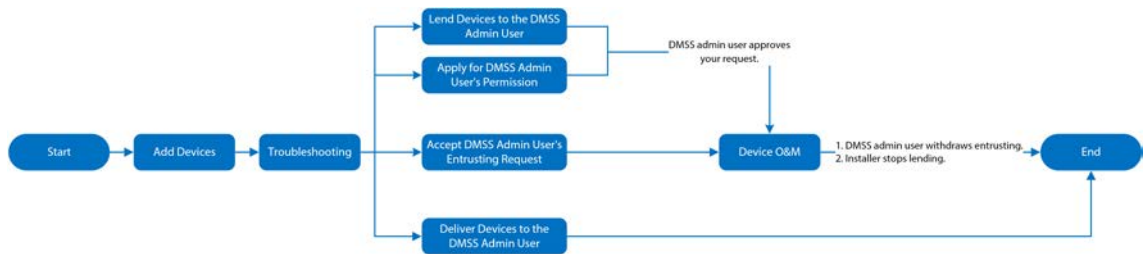

Figure 3-2 Business flow (Installer)



3.2 Operation Process

Follow the procedures below to turn on the wireless alarm system.

Figure 3-3 Operation process



Power On

Connect the hub to the Ethernet, and power on the hub.

Figure 3-4 Power on

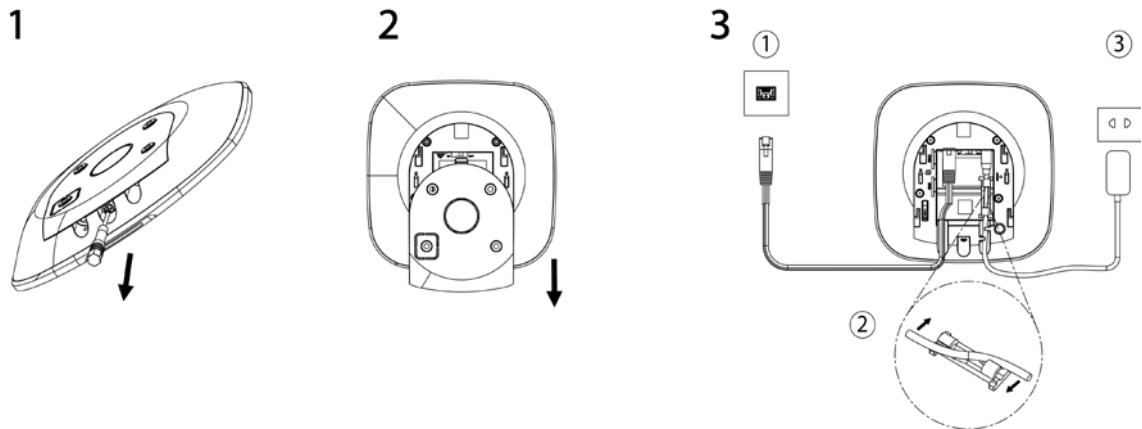

Adding Devices

1. Add the hub to the COS Pro and DMSS app. For details, see "4.2 Adding Devices" and "5.2 Adding Devices".
2. Add the accessories to the hub. For details, see "4.2.2 Adding Accessories" and "5.2.2 Adding Accessories".

Installing the Hub

We recommend using expansion screws to install the hub. Do not place the hub in the following areas:

- Outdoors.
- Places close to metal objects that cause attenuation and shielding of the radio signal.
- Places with a weak GSM signal.
- Places close to radio interference sources that are less than 1 meter away the router and power cables.
- Places where the temperature and humidity exceed allowed limits.

Figure 3-5 Installation

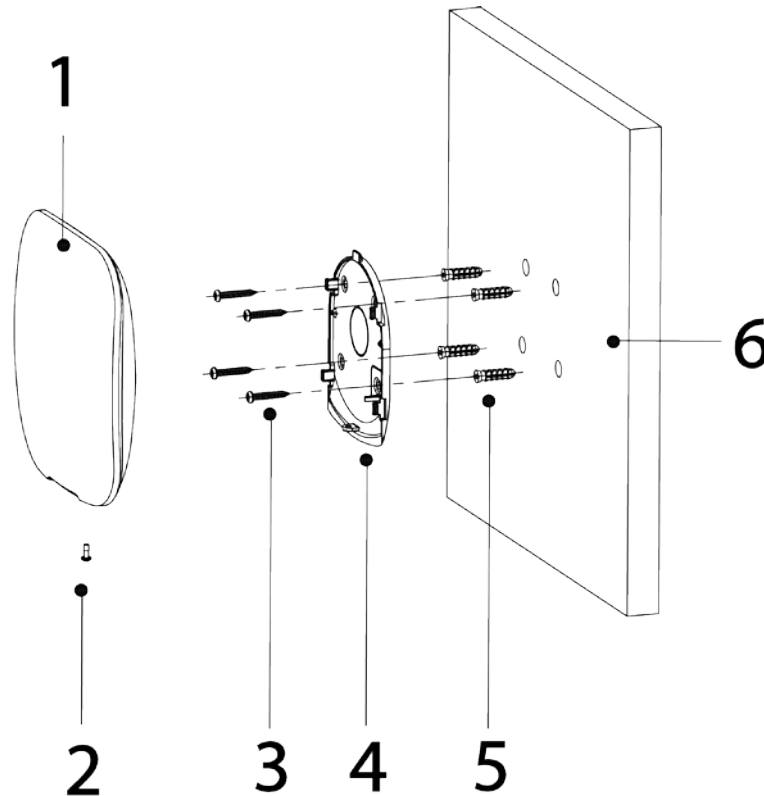

Table 3-2 Installation items

No.	Item Name	No.	Item Name
1	Hub	4	Mounting plate
2	M3 × 8 mm countersunk head screw	5	Expansion bolt
3	ST4 × 25 mm self-tapping screw	6	Wall

1. Confirm the position of the screw holes, and then drill them into the mounting plate.
2. Put the expansion bolts into the holes.
3. Attach the mounting plate into the wall, and then align the screw holes on the plate with the expansion bolts.
4. Fix the mounting plate with ST4 × 25 mm self-tapping screws.
5. Put the alarm hub into the mounting plate from top to bottom.
6. Fix the alarm hub and mounting plate with M3 × 8 mm countersunk head screws.

Configuring the Hub

Configure the hub on the COS Pro and DMSS app. For details, see "4.6.2 Device Basic Configurations".

Arming the Alarm System

You can use the keypad, keyfob and app to arm your system. After an arming command is sent to the COS Pro and DMSS app, the system will check the status of the system. If the system has a fault, you will need to choose whether to force arm it. For details on arming and disarming the system, see "6 General Operations". For details on accessories, see the user's manual of the corresponding device.

4 COS Pro Operations for Installers

COS Pro app is designed to help installers by providing professional operation and maintenance services for end users. It provides functions including site management, operation and device health management, device entrusting review, and more. For details, see *COS Pro App_User's Manual*.



The figures are for reference only and might differ from the actual interface.

4.1 Logging in to COS Pro

For first-time use, you need to create an account. This user manual uses the operations on iOS as an example.

Step 1 Search for COS Pro in app store, and then download the app.



For Android users, you can go to Google Play to download COS Pro.

Step 2 On your phone, tap  to start the app.

Figure 4-1 Login



Step 3 Create an account.

1. On the **Login** screen, tap **sign up**.
2. On the **Register** screen, fill in the information for the required fields.

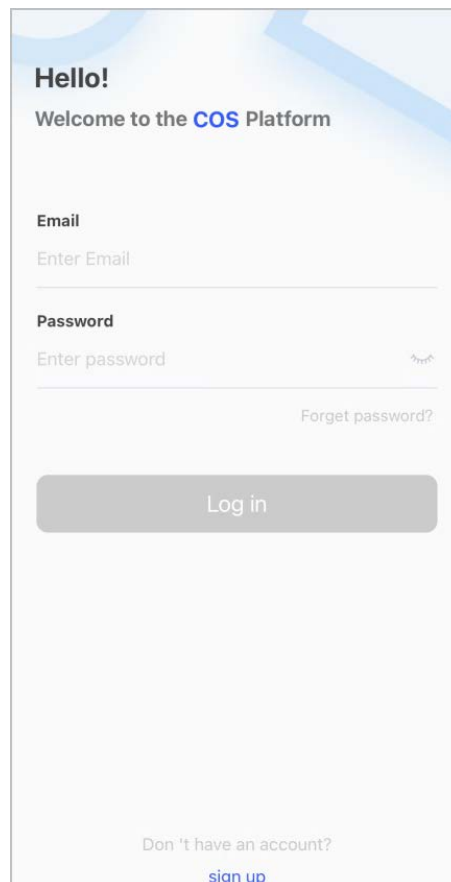
If the country/region that you select is from North America, then the **Dealer Registration Number** will appear on the **Register** screen. For all other countries and regions, **Company Name** will appear.

- **Email:** Enter your email address.
- **Country/Region:** Select country/region, province/state, and city of your company.
- **Address:** Enter detailed address of your company.
- **Company Name:** Enter your company name.
- **Dealer Registration Number:** Enter dealer registration number.



For customers in North America, enter dealer registration number.

- **Invitation Code:** Enter the invitation code, which can be obtained from the inviter.
- **Password** and **Confirm Password:** Enter password and confirm it again.
- **Verification Code:** Tap **Send**, check your email box to receive a verification code, and then enter the code in **Verification Code**.

3. Read the **Privacy Policy** and **Service Protocol**, and then select the **I have read and agree to Privacy Policy and Service Protocol** checkbox.
4. Tap **Register**, and then the app returns to the **Login** screen.

Step 4 Enter your email address and password, and then tap **Log in**.

- For new customers, account application approval is needed. It will take 1-3 days to receive an account approval email. After that, you can log in to the app with your account.
- Some affiliated customers do not need to be approved to register for a COS Pro account. They can directly log in to the app after registration.

4.2 Adding Devices

For installers, you can add devices to the COS Pro app for management and maintenance. Before adding devices, make sure that the device is connected to power and the network. You can add alarm devices, including hubs and multiple accessories into the app.

4.2.1 Adding the Hub

The hub can be added either in **Site mode** or **Device mode**. If you add devices in the **Device mode**, you need to select a site first. The operations for these two modes are similar. This section uses configurations in **Device mode** as an example.

- Before adding the hub, make sure that the hub is connected to power and the network.
- Make sure that your phone has enabled Wi-Fi function.

4.2.1.1 Adding by SN/QR Code

You can add the hub by scanning the QR code of the device or manually entering device SN in the wireless or wired network.

Step 1 On the **Home** screen, tap , and then it goes to **Sites** screen.

Figure 4-2 Add a device

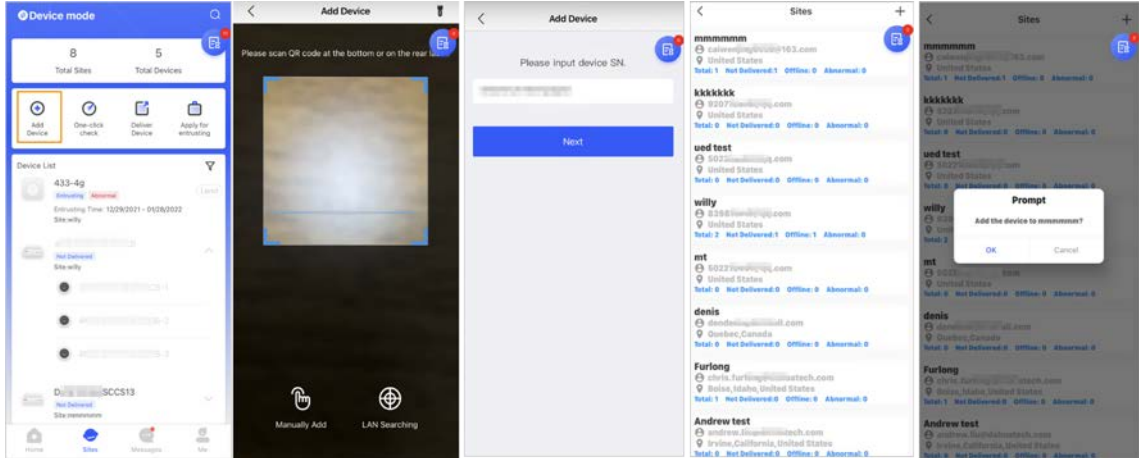

- Step 2** Tap on the upper-left corner to switch to **Device mode**.
- Step 3** Tap to add a device.
- Step 4** Scan device QR code, or tap **Manually Add** to manually enter device SN.
- Step 5** Select a site, and then tap **OK**.
- Step 6** On the **Add Device** screen, select a device type.
- Step 7** Connect to wireless or wired network.

- **Wireless**

- 1) Tap **Wireless** on the upper-right corner, and then **Wireless** becomes **Wired**.
- 2) Enter the password for the Wi-Fi that your phone is connected to, and then tap **Connect**.
- 3) Follow the on-screen instructions, and then tap **Next**.
- 4) Wait for the pairing.



If failed, repeat the above procedures.

- **Wired**

- 1) Tap **Wired** on the upper-right corner, and then **Wired** becomes **Wireless**.
- 2) Connect the device to power and the network, and then tap **Next**.



If failed, repeat the above procedures.

- Step 8** If the hub you are adding is uninitialized, enter password and confirm it again, and then tap **Initialize the device** to complete initialization.
- Step 9** Tap **Completed**, and then you can view the device in the device list.

4.2.1.2 Adding through AP Configuration

You can add the hub through AP configuration.

- Step 1** On the **Home** screen, tap , and then it goes to **Sites** screen.
- Step 2** Tap on the upper-left corner to switch to **Device mode**.
- Step 3** Tap to add a device.

Figure 4-3 Add a device

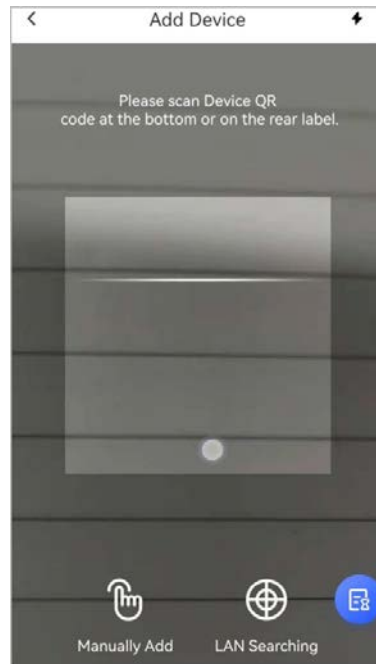

Step 4 Scan device QR code, or tap **Manually Add** to manually enter device SN.

Step 5 On the **Add Device** screen, select **Alarm Station**.

Figure 4-4 Select alarm station



Step 6 Follow the on-screen instructions and flip the DIP switch from STA to AP.

Step 7 Tap **Join** to connect to the device hotspot.

Step 8 Set device password to initialize the device, and then tap **Next**.

Figure 4-5 Add through AP configuration

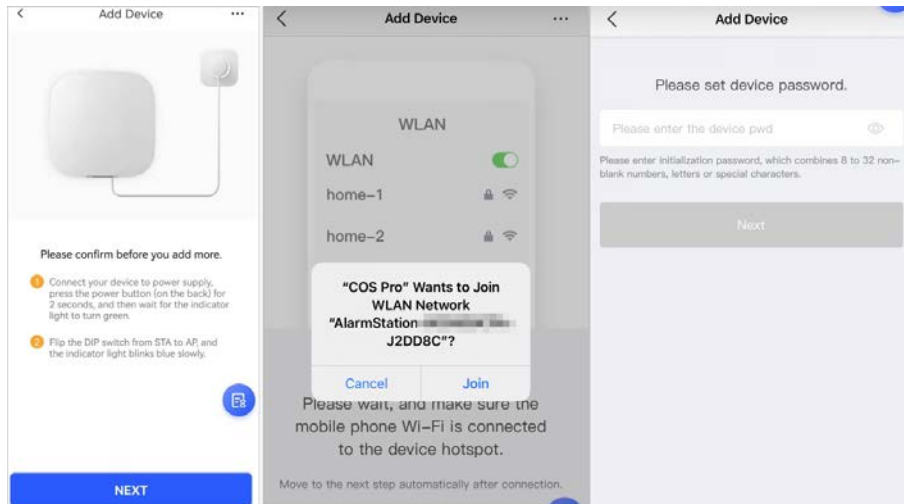

Step 9 Connect to the network.

1) Select Wi-Fi.

Make sure that your phone and the device are connected to the same network.

2) Enter Wi-Fi password, and then tap **Next**.

3) Flip the DIP switch from AP to STA, and then tap **Next**.

4) Wait for device to complete network configuration.

Figure 4-6 Connect to the network

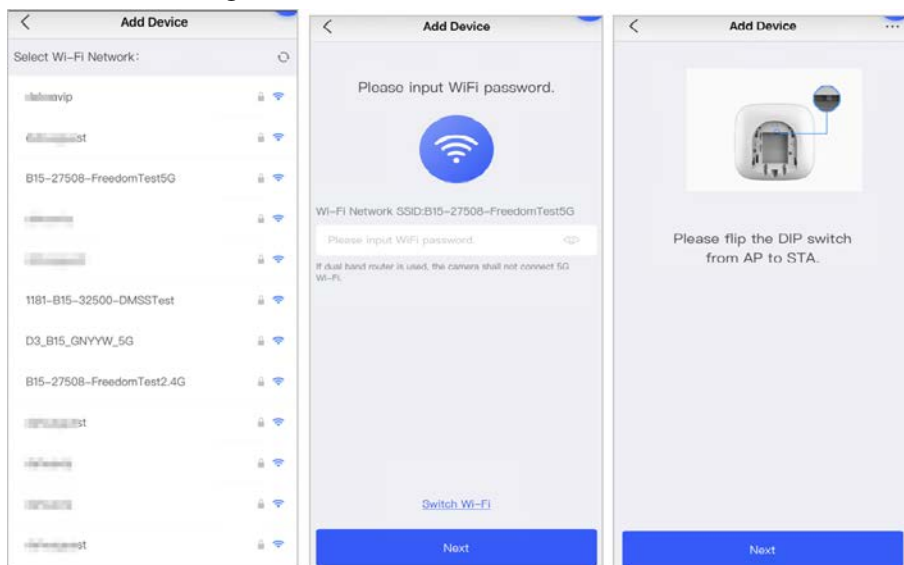

Step 10 Tap **Completed**.

4.2.1.3 Adding by LAN Searching

You can search for devices and add them. Make sure that your phone and the devices are connected to the same network.

Step 1 On the **Home** screen, tap , and then it goes to **Sites** screen.

Step 2 Tap  on the upper-left corner to switch to **Device mode**.

Step 3 Tap  to add a device.

Figure 4-7 Add a device

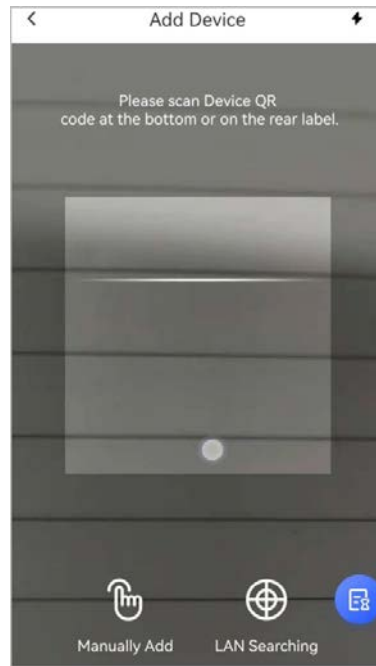

Step 4 Tap **LAN Searching**.

Step 5 On **Add Device** screen, enter device password, and then tap **Confirm**.

Figure 4-8 Confirm to add a device

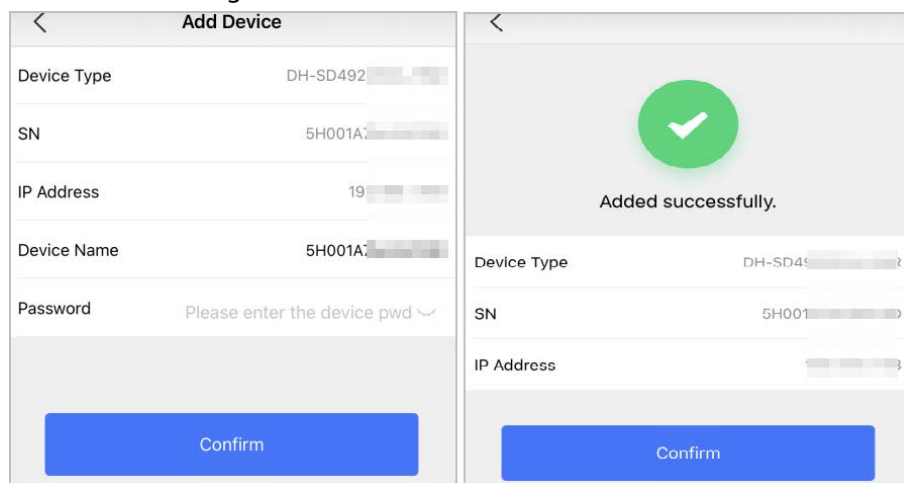

4.2.2 Adding Accessories

You can add multiple accessories into the hub. The section uses door detector as an example. For details on adding accessories, see user's manuals of respective accessories.



Up to 6 sirens, 64 keyfobs, 4 repeaters, and 8 keypads can be added to a hub.

Step 1 On the hub screen, tap  on the upper-right corner, and then scan QR code at the bottom of door detector.

Step 2 Tap **Next**.

Step 3 Follow on-screen instructions and switch the door detector to on, and then tap **Next** to add it to the hub.

Step 4 Wait for the pairing.

Step 5 Customize the name of the door detector and select the area, and then tap **Completed**.



- Delete the accessory: Go to the hub screen, select the accessory from the list, and then swipe left to delete it.
- Up to 32 areas can be created in a hub.

4.3 Managing Users

4.3.1 Adding DMSS Admin Users

For installer, you can add DMSS admin users by sharing entrusting devices with them or accepting their entrusting request.



The DMSS admin user does not have permission to configure the device when installers lend the hub to them, or when they entrust the hub to the installer.

4.3.1.1 Lending the Device to the DMSS Admin Users

The installer can lend the hub to the DMSS admin user. Afterwards, the installer needs to apply for permissions from the DMSS admin user, such as device configuration, arming and disarming operations, and user management.



Make sure that the hub has not been added by other accounts.

Step 1 On the **Home** screen, tap , and then it goes to **Sites** screen.

Figure 4-9 Lend the hub to the DMSS admin user

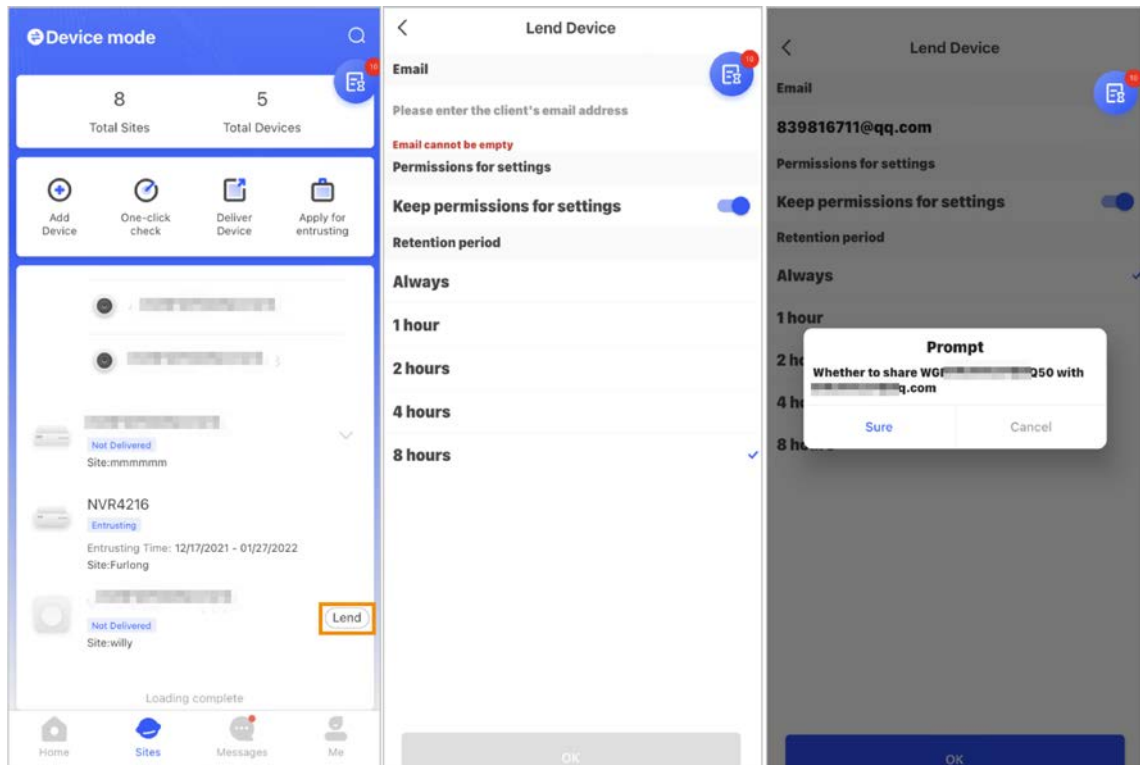

- Step 2** Tap on the upper-left corner to switch to **Device mode**.
- Step 3** In the device list, select a hub, tap **Lend** on the right corner of the hub.
- Step 4** Enter email of the DMSS admin user.
- Step 5** Enable **Reserve Configuration Permissions** and select retention time.
- Step 6** Tap **Confirm**.
- Step 7** On the screen, tap **Personal Message**, you can view messages to see whether the DMSS admin user agreed to accept your request to share with them.



A sharing message will be sent to the DMSS admin user account, and the DMSS admin user can read the message in the DMSS app.

4.3.1.2 Accepting Entrusting Requests

The installer can accept DMSS admin user's entrusting request.

- Step 1** On the **Home** screen, select **Pending Task > Entrusting Review**.
- Step 2** On the **Pending Task** screen, select a task to view task details and handle entrusting applications.

Figure 4-10 Handle entrusting tasks

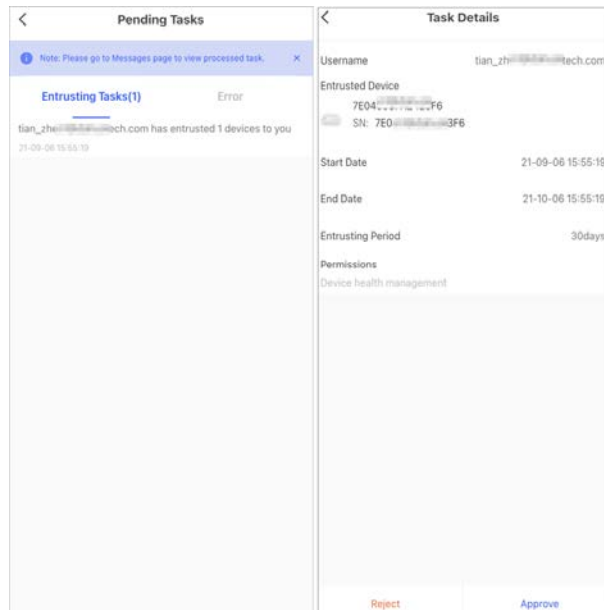

- To approve
 - 1) Tap **Approve**, and then it goes to the **Unallocated Devices** screen.
 - 2) Select devices to be allocated or tap **Select all**, and then tap **Add to Sites**.

Figure 4-11 Add device to sites

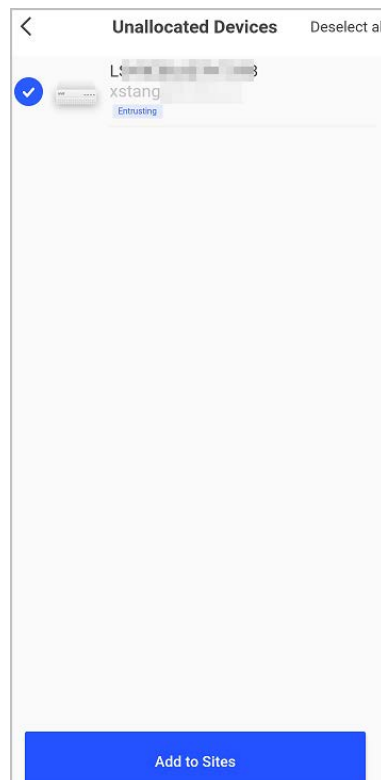

- 3) On the **Sites** screen, select a site or add a new site.
 - 4) Tap **OK** to confirm move this device to the selected site.
- To reject: Tap **Reject**, enter reasons for rejection, and then tap **Sure**.

Figure 4-12 Reject

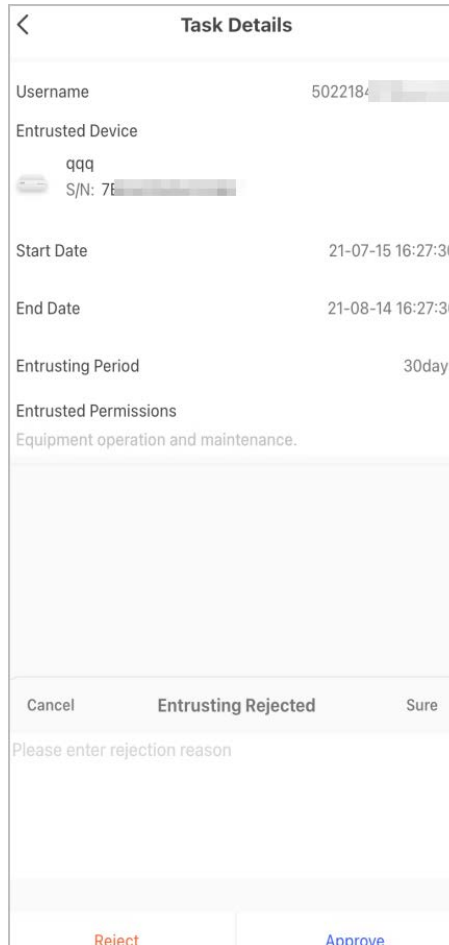

Task Details

Username 5022184

Entrusted Device
qqq
S/N: 7E

Start Date 21-07-15 16:27:30

End Date 21-08-14 16:27:30

Entrusting Period 30days

Entrusted Permissions
Equipment operation and maintenance.

Cancel Entrusting Rejected Sure

Please enter rejection reason

Reject Approve

4.3.2 Deleting Users

For installer, you can delete a user by cancelling to lend the devices to DMSS admin user or deleting the devices.

4.3.2.1 Cancelling to Lend the Devices

For installer, you can delete DMSS admin users by cancelling to lend the hub to them.

Step 1 On the **Home** screen, tap , and then it goes to **Sites** screen.

Figure 4-13 Lend the hub to the DMSS admin user

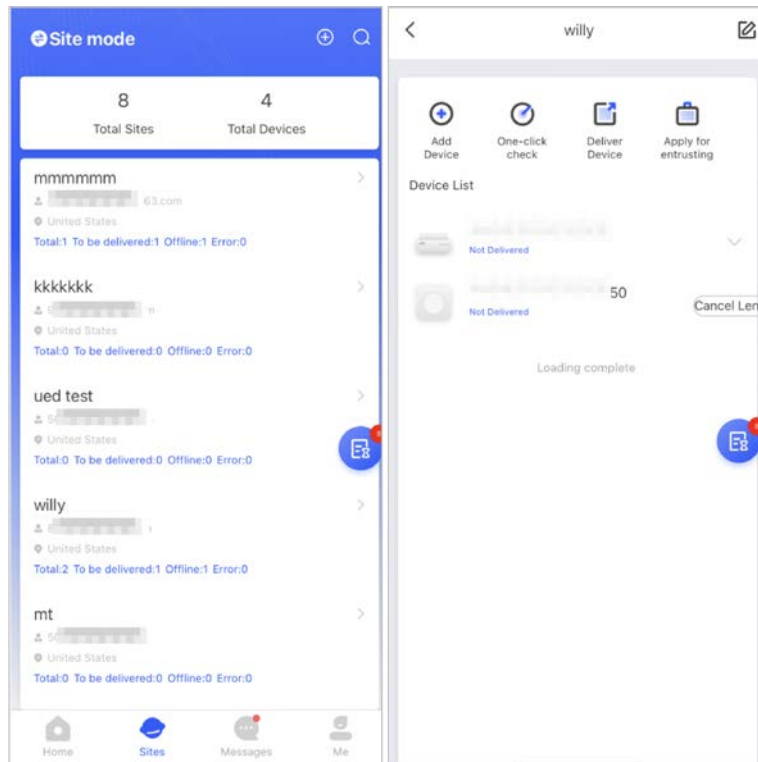

Step 2 Tap on the upper-left corner to switch to **Site mode**.

Step 3 In the site list, select the site with the device that you lend to the DMSS admin user, then select the hub, and then tap **Cancel Lend**.



The message will be sent to the DMSS admin user account, and the DMSS admin user can read the message in the DMSS app.

4.3.2.2 Deleting Devices

For installer, you can delete DMSS admin users by deleting devices.



- Make sure the installer has cancelled to lend the devices to the DMSS admin user.
- The installer can delete all DMSS users if DMSS admin user has shared the devices to the DMSS general users.

Step 1 On the **Home** screen, tap , and then it goes to **Sites** screen.

Step 2 Tap on the upper-left corner to switch to **Device mode**.





Step 3 In the device list, select the device as needed.

Step 4 On hub screen, tap , and then tap **Delete** to delete the device.

4.4 Applying for DMSS Admin User's Permission

For installers, you can add the hub directly to the COS Pro app to provide device operation and maintenance services for the DMSS admin users. You have time-limited permissions, including

device configuration and user management, and need to re-apply for permission upon expiry.

- Step 1 On the **Home** screen, tap , and then it goes to **Sites** screen.
- Step 2 Tap  on the upper-left corner to switch to **Device mode**.
- Step 3 In the device list, select the device as needed.
- Step 4 On the **Hub** screen, select  > **Hub Setting**, tap any parameter that you want to configure, and then a prompt will pop up to remind you to apply for permissions from the DMSS admin user.
- Step 5 Tap **Sure**.
- Step 6 Select permission hours, and then tap **Confirm**.
- Step 7 On the  screen, tap **Personal Message** to view messages to see whether the DMSS admin user agreed to assign permissions to you.





A request message will be sent to the DMSS admin user account, and the DMSS admin user can read the message in the DMSS app.

4.5 Delivering Devices to DMSS Admin User

After debugging the devices, you can deliver devices to the DMSS admin user. Offline and entrusted devices cannot be delivered.



The requirements of En50131 certifications will not be met if the installer delivers the hub to a DMSS admin user.

- Step 1 On the **Home** screen, tap , and then it goes to **Sites** screen.
- Step 2 Tap  on the upper-left corner to switch to **Site mode**.
- Step 3 In the site list, select a site with devices that need to be delivered to the DMSS admin user.
- Step 4 Tap , and then it goes to **Deliver devices** screen.



No more than 5 devices can be delivered at a time.

- Step 5 Enter the DMSS admin user's emails, and then tap **Sure** to view deliver results. For devices that failed to be delivered to DMSS admin user, go to the **Failed** screen to deliver again.



If customers are using Imou account, then their devices will not be delivered successfully. And a message will pop up on the **Home** screen stating that the account does not have the permission. Please ask the customer to update the account on the DMSS app. For details, see *DMSS App_User's Manual*.

4.6 Operation and Device Health Maintenance

Installers can provide operation and device health maintenance services, such as checking the

health status of devices, remotely configuring devices, and fixing errors.

4.6.1 Checking Device Health Status

You can check the online and offline status of devices in real time, and check the health status of devices one at a time or in batches. This section uses checking in batches as an example.

The configurations for these can be found in **Site mode** and **Device mode**. The operations for these two modes are similar. This section uses configurations in **Device mode** as an example.

Step 1 On the **Home** screen, tap , and then it goes to **Sites** screen.

Step 2 Tap  on the upper-left corner to switch to **Device mode**.

Step 3 Tap .

Step 4 Select devices you want to check, and then tap **X devices selected. Start Health Check.**



To select all devices, tap **Select all**.

Step 5 View checking results, and then tap **OK**.



Offline devices cannot be checked.

4.6.2 Device Basic Configurations

After adding devices, including the alarm hub and accessories, you can view and edit general information of the device.

Step 1 On the **Home** screen, tap , and then it goes to **Sites** screen.

Step 2 Tap  on the upper-left corner to switch to **Device mode**.

Step 3 In the device list, select the device as needed.





Step 4 On hub screen, tap  to view and edit general information on the device.

Table 4-1 Parameter description















Parameter	Description
Device Configuration	<ul style="list-style-type: none"> View device name, type, and SN. Edit device name, and then tap Save to save configuration.
Hub Status	For details, see "4.6.2.2 Configuring the Hub".
Hub Setting	For details, see "4.6.2.1 Viewing Status".
Time Zone	Tap Time Zone to select your time zone, and enable DST (daylight saving time) if necessary. <ul style="list-style-type: none"> Time Zone: Select the time zone in which the hub operates. DST: Select date or week, and then select start time and end time.
Network Configuration	Tap Network Configuration to view your present network information.

Parameter	Description
Device Sharing	Tap Device Sharing to share the status of the hub with the other users. For details, see "4.3.1.1 Lending the Device to the DMSS Admin Users".
Cloud Update	Update online.  Update is not allowed when the hub is in armed status or the battery level is low.
Log	Device and app logs. <ul style="list-style-type: none"> • Device log: Select Log > Device log to view alarm logs of the device. You can also tap  on the Device log screen to send alarm logs to the linked email. • App log: Select Log > App log to view alarm logs of the COS Pro. You can also tap  on the App log screen to send alarm logs to the linked email.

4.6.2.1 Viewing Status

On the **Hub** screen, select  > **Hub Status** to view the status of the hub.

Table 4-2 Status

Parameter	Description
GSM Signal Strength	The signal strength of the mobile network for the active SIM card. <ul style="list-style-type: none"> • : Ultra low. • : Low. • : Moderate. • : High. • : No.
Wi-Fi Signal Strength	Internet connection status of the hub via Wi-Fi. For greater reliability, we recommend installing the hub in places with the signal strength of at least 2 bars. <ul style="list-style-type: none"> • : Ultra low. • : Low. • : Moderate. • : High. • : No.
Storage Battery	Show remaining electricity of the battery. <ul style="list-style-type: none"> • : Fully charged. • : Sufficient. • : Moderate. • : Insufficient.
Anti-tampering	The tamper mode of the accessory, which reacts to the detachment of the body.
Main Power Status	Show main power status.





Parameter	Description
GSM Connection Status	Internet connection status of the hub via SIM card, Wi-Fi, and Ethernet.
Wi-Fi Connection Status	
Network Cable Connection Status	
SIM Card Status	Connection status of the SIM card. <ul style="list-style-type: none"> • : SIM card 1 is active. • : SIM card 2 is active. • : No SIM card.
Program Version	The program version of the hub.



4.6.2.2 Configuring the Hub

On the **Hub** screen, select > **Hub Setting** to configure the parameters of the hub.

Table 4-3 Hub parameter description

Parameter	Description
Global Arming/Disarming	Arm or disarm all the detectors in all the areas with one tap.
Schedule Arming/Disarming	Arm or disarm the areas by schedule. <ul style="list-style-type: none"> • Area: Select the area in which the hub operates. • Command setting: Select an armed mode as needed by tapping Home, Away, or Disarm. • Time: Select the time period in which the hub operates. • Repeat: Copy the arming or disarming schedule. • Force Armed: You can arm the system when errors happen in zones.
Ringtone Setting	The ringtone when entering or exiting the arming mode.
LED Indicator	<p>LED Indicator is enabled by default. For details on indicator behavior, see "2.1 Appearance".</p> <ul style="list-style-type: none"> • If LED Indicator is disabled, the LED indicator will remain off regardless of whether the hub is functioning normally or not. • The function is only available when the version of the DMSS app is 1.96 or later, and the hub is V1.001.0000000.4.R.211014 or later.
Test Mode	Tap Start to test the status of the accessories connecting to the hub in different areas, and then tap Stop to complete detection.
Reduced Sensitivity Mode	Enable Reduced Sensitivity Mode , and then the hub's transmit power will be reduced. <p>The function is only available when the version of the DMSS app is 1.97 or later, and the hub is V1.001.0000000.6.R.211215 or later.</p>

Parameter	Description
Cloud Service Connection	<p>Set the server-hub ping interval with the range from 150 to 900 seconds (150 seconds by default). If the D-cloud detects that the hub's offline duration exceeds 150 seconds, it will report the hub status to the user through app.</p>  <p>The function is only available when the version of the DMSS app is 1.96 or later, and the hub is V1.001.0000000.6.R.211215 or later.</p>
Heartbeat	<p>Configure the hub-detector ping interval. The settings determine how frequently the hub communicates with the accessories and how quickly the loss of connection is detected.</p> <ul style="list-style-type: none"> Detector Ping Interval: The frequency of connected accessories operated by the hub is configured in the range of 12 seconds to 300 seconds (60 seconds by default).  <p>The shorter the detector ping interval, the shorter the life span of the battery.</p> <ul style="list-style-type: none"> Number of undelivered packets to determine connection failure: A counter of undelivered packets is configured in the range of 3 to 60 (15 packets by default).  <ul style="list-style-type: none"> The smaller the number, the more frequently the offline status of accessories is detected and reported. If the hub constantly loses connection with the accessories and cannot detect their defined heartbeats, it will report their offline status to the system.
Anti-tampering Speaker	<p>Alert with a siren if the back cover of accessories and hub is open.</p>
System Integrity Check	<p>When enabled, the hub checks the status of all detectors before arming, such as battery charge level, tamper incidents, and connectivity. If errors are detected, warnings will be displayed.</p>  <ul style="list-style-type: none"> For the keyfob, the indicator flashes green, and then turns red. For the app, an alarm message pops up. For the keypad, it beeps for 1 second, the arming and disarming indicator flashes green for 2 seconds, and then it turns to the normal status.
CMS	<p>Enter IP address, port and device ID, and then you can register the hub to the D-cloud.</p>  <p>The function is only available when the version of the DMSS app is 1.96 or later, and the hub is V1.001.0000000.6.R.211215 or later.</p>

Parameter	Description
Monitoring Station	<p>Enable Monitoring Station, and then set the SIA protocol parameters for the alarm receiving center (ARC).</p> <ul style="list-style-type: none"> ● Preferred IP address: Enter the IP address and port number of the ARC. ● Alternative IP address: Enter the alternative IP address and port number of the ARC. <p></p> <ul style="list-style-type: none"> ◇ Messages will be sent to the alternative IP address only when the preferred IP address fails to receive the message. ◇ If Heartbeat interval is enabled, the system will judge whether to send the message to the preferred or alternative IP address. <ul style="list-style-type: none"> ● IP Protocol: Select TCP by default. ● Heartbeat interval: Set the heartbeat interval with the range from 0 second to 24 hours (60 seconds by default). <p></p> <p>0 seconds means Heartbeat interval is disabled.</p> <ul style="list-style-type: none"> ● Central account: Enter the account number that created by the ARC, which is to be used to identify the hub when the hub sends information to the ARC. ● Encryption: The hub uses an encryption format for information security when you configure the ARC. AES128 is set by default. ● Upload event: Tap <input checked="" type="checkbox"/> next to an event to upload it. <ul style="list-style-type: none"> ◇ Alarm: Alarm message. ◇ Error: Power failure, battery undervoltage, tamper, and offline. ◇ Event: Prohibit the use of peripherals, add or delete peripherals, and add or delete users. ◇ Arm/Disarm: Message notifications of arming and disarming the system.

4.6.3 Fixing Errors

You can fix errors after abnormal devices are checked. Errors are found in two ways, including device automatic reporting and manual checking.

Step 1 On the **Home** screen, select **Pending Task > Error Fixing**.

Step 2 In the error list, tap an error task, and then tap **Start processing**.

Step 3 Fix the error according to the suggestions.

Step 4 Tap **Error Fixed** if the error is fixed, and then wait for the customer to confirm it.



Customers will be notified of the fixing status of errors. If they confirm that the error has been fixed, they will be asked to evaluate the service.

4.6.4 Viewing Evaluations

After remotely configuring devices, and having fixed errors, customers will evaluate how operators performed in error fixing and device health maintenance. The admin account can view details on errors such as error type, the time the error occurred, suggestions and operation, the name of the operator and ratings.

Step 1 On  screen, tap **Error Notification**.

Step 2 In the message list, tap a message to view message details, including customer username, operator username, device details, error details, error fixing details and rating.

5 DMSS Operations for End Users

DMSS app provides professional security surveillance services for end users. For DMSS admin users, you can share the hub with up to 6 DMSS general users and entrust it to one enterprise. Accessories that come with the hub can be shared and entrusted at the same time. To share and entrust the hub by yourself, you need to install the latest version of DMSS app.



The figures are for reference only and might differ from the actual interface.

5.1 Logging in to DMSS

The security system is configured and controlled through DMSS app. You can access to DMSS app on iOS and Android. This section uses the operations on iOS as an example.



Make sure you have installed the latest version of the app.

Step 1 Search for DMSS in the app store, and then download the app.



For Android users, you can go to Google Play to download DMSS.

Step 2 On your phone, tap  to start the app.

Figure 5-1 Login



Step 3 Create an account.

- 1) On the **Login** screen, tap **Sign up**.
- 2) Enter your email address and password.

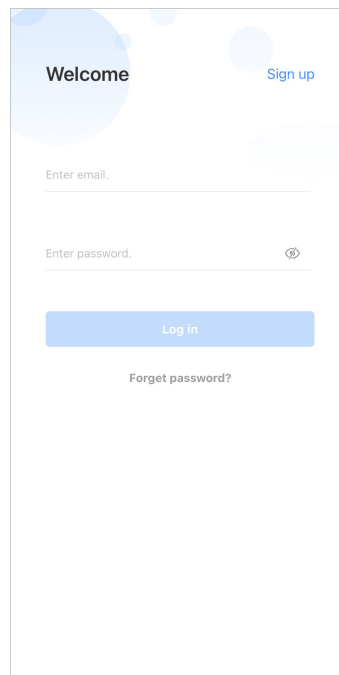

Tap to show the password, and the icon will become .

3) Read the **User Agreement** and **Privacy Policy**, and then select the **I have read and agree to** checkbox.

4) Tap **Get verification code**, check your email box for the verification code, and then enter the code.



Use the verification code within 60 seconds of receiving it. Otherwise, the verification code will become invalid.

5) Tap **OK**.

Step 4 On the **Login** screen, enter your email and password, and then tap **Log in**.



You can modify the password on the **Me > Account Management > Modify Password**.

5.2 Adding Devices

For end users, you can add alarm devices to DMSS app.

5.2.1 Adding the Hub

You can add the hub by manually entering the device SN and scanning the QR code.

Step 1 On the **Home** screen, tap , and then select **SN/Scan**.

Figure 5-2 Add by SN/QR code

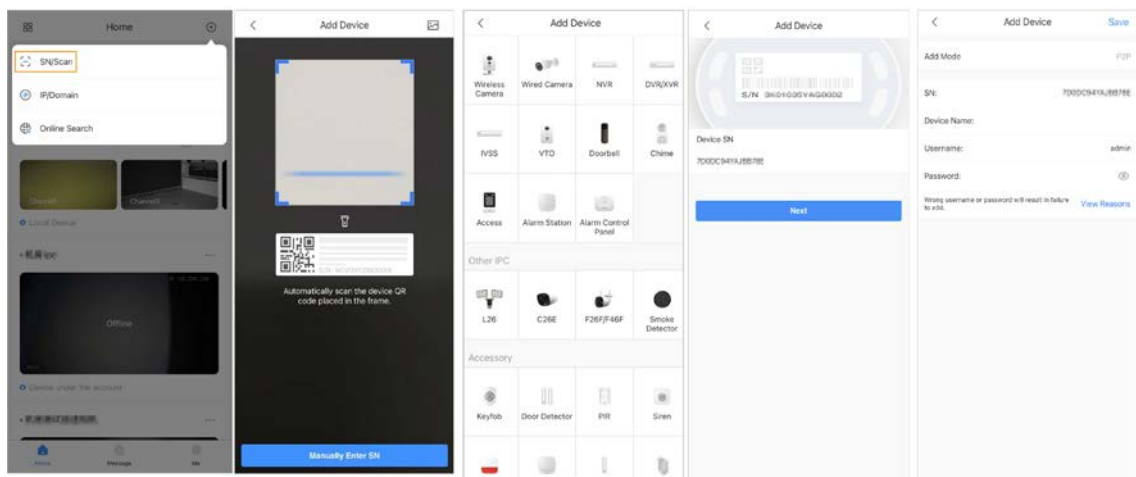

Step 2 Add a device.

- Scan the device QR code directly, or tap and import the QR code picture to add a device.
- Tap **Manually Enter SN**, and then enter the device SN to manually add a device.

Step 3 Select the device type, and then tap **Next**.



Tap **Next** if the system identifies the device type automatically.

- Step 4** On the **Add Device** screen, customize the device name, enter the username and the device password, and then tap **Save**.

5.2.2 Adding Accessories

For end users, you can add multiple accessories into the hub. The operations to add accessories on DMSS are the same as that on COS Pro. For details, see "4.2.2 Adding Accessories".

5.3 Hub General Settings

5.3.1 Hub Configuration

On the **Device Details** screen, tap , and then you can view and edit general information of the hub. General information of the device displayed on the DMSS app is the same as that on the COS Pro app. For details, see "4.6.2 Device Basic Configurations".

5.3.2 Network Configuration

In **General Config** on the **Device Details** screen, tap **Network Configuration**, and then you can select a network connection type for the hub: Wired network, wireless network or cellular network.

5.3.2.1 Wired Network Configuration

Step 1 Select **Network Settings > Wired Network Config**.

Step 2 Configure wired network connection parameters.

Table 5-1 Description of wired network parameters

Parameter	Description
DHCP	When there is a DHCP server on the network, you can enable DHCP , and then the hub gets dynamic IP address automatically.
IP Address	Set the IP address manually: Set IP address, subnet mask, default gateway and DNS manually for the hub.
Subnet Mask	
Alarm Hub	
DNS	
DNS 2	

5.3.2.2 Wi-Fi Network Configuration

Step 1 Select **Network Settings > Wi-Fi Network Configuration**.

- Step 2** Select an available Wi-Fi network in the area, and then enter the network password to connect to the network.

5.3.2.3 Cellular Configuration

- Step 1** Select **Network Settings > Cellular**.
- Step 2** Configure cellular parameters.

Table 5-2 Description of cellular parameters

Parameter	Description
Cellular	Tap <input type="checkbox"/> next to the Cellular to enable the cellular.
Priority	Tap <input type="checkbox"/> next to the Priority to set the cellular as the priority when selecting the network.
SIM 1	<ul style="list-style-type: none"> • Supports dual SIM cards and single standby. • SIM cards allow the hub to use cellular data, and push alarm notifications.
SIM 2	
APN	The Access Point Name (APN) is the name of the settings your device reads to set up a connection for the gateway between your carrier's cellular network and the public Internet.
Auth Mode	Authentication mode of the cellular networking.
Username	The username and password of the cellular network.
Password	
Dial Number	The number that the hub is to call.
Mobile Data Usage	View the usage of the mobile data.
Reset Statistics	Reset mobile data usage to restart the count.

5.4 Managing Users

5.4.1 Adding Users

For DMSS admin users, you can add both installers and DMSS general users.

5.4.1.1 Adding DMSS General Users

You can share devices with up to 6 DMSS general users.

You can go to **...** > **Device Details** > **<**, or **...** > **Device Details** > **Device Sharing** to share the device. These methods are similar. This section uses sharing devices on **...** > **Device Sharing** as an example.

- Step 1** On the **Home** screen, tap **...** next to a device, and then tap **Device Sharing**.

Figure 5-3 Share device

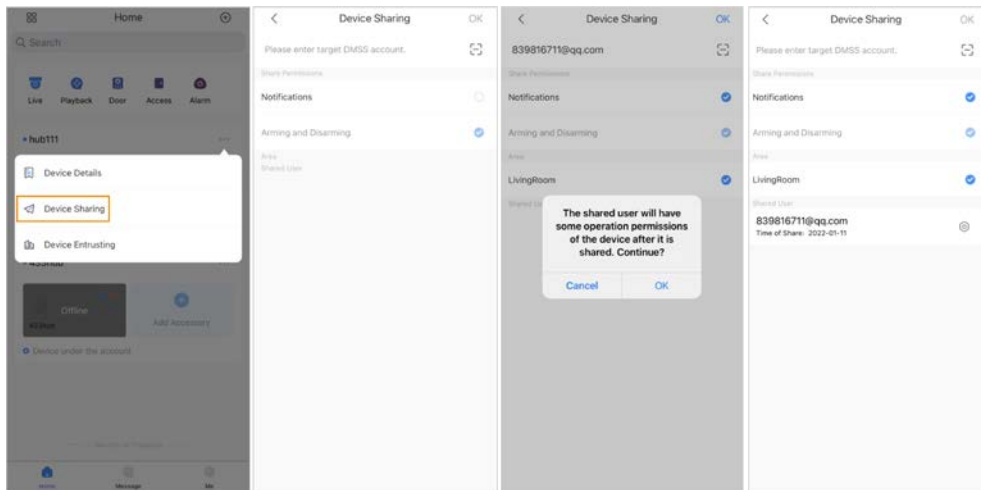

Step 2 On the **Device Sharing** screen, share the device with the user by entering their DMSS account or scanning their QR code.

Step 3 Select device permissions for users based on your actual need.

Step 4 Tap **OK**.

The account that you shared the device with will appear on the **Shared User** section of the **Device Sharing** screen.

5.4.1.2 Adding Installers

For DMSS admin users, you can add installers by entrusting devices to them. You can entrust devices to the installer one by one or in batches.



5.4.1.2.1 Entrusting Device One by One

Procedure

Step 1 On the **Home** screen, tap **•••** next to a device, and then tap **Device Entrusting**.

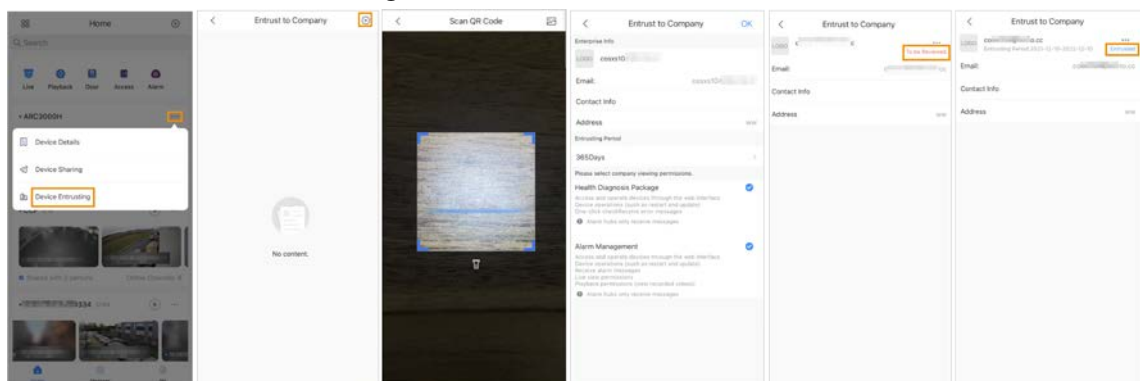
Figure 5-4 Entrust a device



Step 2 On the **Entrust to Company** screen, tap , and then scan the corresponding QR code of the installer, or tap  and import the QR code picture to entrust the device to the installer.



You can ask installers for their QR codes.

Step 3 On the **Entrust to Company** screen, select entrusting periods, and company viewing permissions, and then tap **OK**.



- You must select at least one viewing permission from **Health Diagnosis Package** and **Alarm Management**.
- Enterprise information will be automatically recognized after you scan the QR code of the installer.

Step 4 View entrusting details on the **Entrust to Company** screen.
When successfully entrusted, **To be Reviewed** will change to **Delivered**.



After an entrusting request has been successfully sent, a message will pop up on the **Home** screen. You need to wait for a response from the installer, which will be displayed on the **Me > Mailbox > Personal** screen.

Related Operations

- To change permissions, go to the **Entrust to Company** screen, and then tap **Change Permissions**.
- To withdraw entrusting permissions, go to the **Entrust to Company** screen, and then tap **Withdraw**.
- To renew entrusting periods, go to the **Entrust to Company** screen, and then tap **Renew**.

5.4.1.2.2 Entrusting Devices in Batches

You can entrust devices to one enterprise in batches.

Step 1 On the **Home** screen, select **Me > Batch Entrust**.

Figure 5-5 Entrust devices in batches

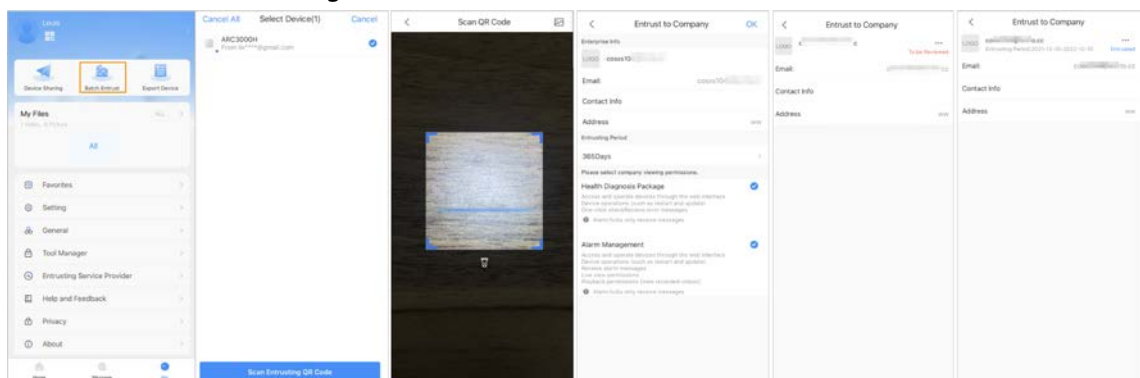

Step 2 On the **Select Device** screen, select the devices to be entrusted, and then entrust those to the enterprise. The process for entrusting multiple devices is the same as entrusting a single device. For details, see "5.4.1.2.1 Entrusting Device One by One".

5.4.2 Deleting Users

For DMSS admin users, you can delete both installers and DMSS general users.

5.4.2.1 Cancelling to Share the Devices

For DMSS admin user, you can delete DMSS general users by cancelling to share the devices with them on the **Device Sharing** screen. For details on going to **Device Sharing** screen, see "5.4.1.1 Adding DMSS General Users". This section uses methods on > **Device Sharing** as an example.

Step 1 On the **Home** screen, tap next to a device, and then tap **Device Sharing**.

Figure 5-6 Share device

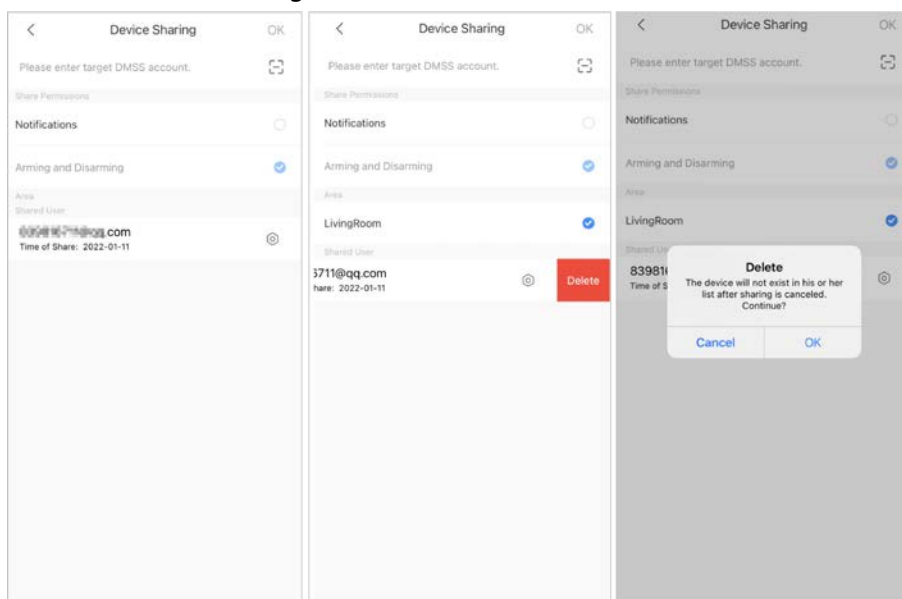

Step 2 In the account list of the **Device Sharing** screen, select an account, swipe the block to the left, and then tap **Delete**.

Step 3 Tap **OK** to cancel sharing.

5.4.2.2 Cancelling Entrusting Application

For DMSS admin users, you can delete an installer by cancelling the entrusting application.

Step 1 On the **Home** screen, tap next to a device, and then tap **Device Entrusting**.

Figure 5-7 Withdraw entrusting application

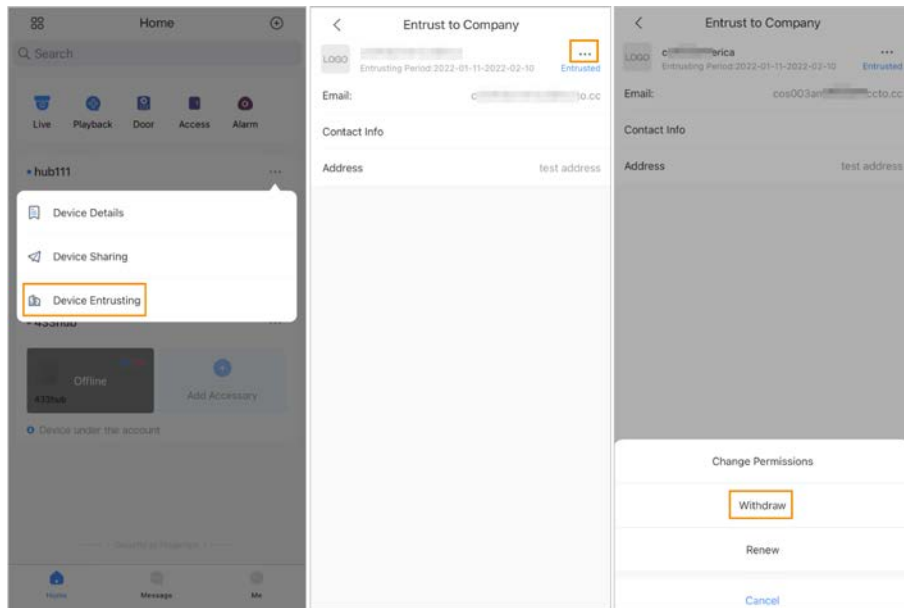

Step 2 On the **Device Entrusting** screen, select **...** > **Withdraw**, and then tap **OK**.



A message will be sent to the account of the installer. After the installer reads the message and approves your request to cancel the entrusting application in COS Pro, your application will be cancelled.

5.4.2.3 Deleting Devices

For DMSS admin user, you can delete both installers and DMSS general users by deleting devices.



DMSS admin user cannot delete an installer if the devices are shared by the installer.

Step 1 On the **Home** screen, select **...** > **Device Details**.

Figure 5-8 Delete the device

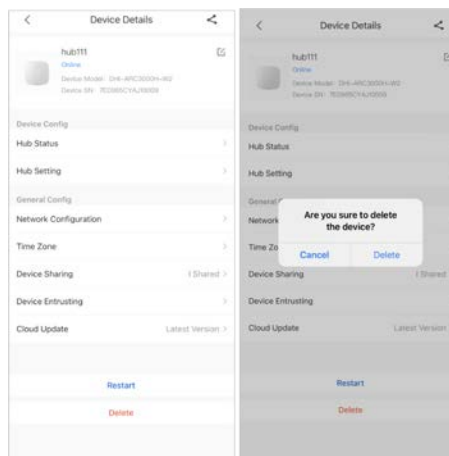

Step 2 On the **Device Details** screen, tap **Delete**.

Step 3 Tap **Delete** to delete the devices.

6 General Operations

The user in level 2 or 3 has the permission to arm and disarm the system. This section uses end user's operation on DMSS as an example.

Prerequisites

- Make sure that you have added a hub before performing configurations.
- Make sure that the hub has a stable internet connection.
- Make sure that the hub is disarmed.

Background Information

You can manage alarm hubs and accessories, and perform operations such as arming and disarming, configuring alarm devices.

Procedure

- Step 1 On the hub screen, tap **Accessory** to add the accessories. For details on adding the accessories, see the user's manual of the corresponding device.
- Step 2 Arm and disarm the detectors in a single area or all the areas through manual or scheduled operations.
- **Single Arming and Disarming:** Arm and disarm the detectors in a single area. For details, see "6.1 Single Arming and Disarming".
 - **Global Arming and Disarming:** Arm and disarm the detectors in all the areas. For details, see "6.2 Global Arming and Disarming".
 - **Manual Arming and Disarming:** Arm the security system through the DMSS app, keypad or keyfob.
 - **Schedule Arming and Disarming:** Arm and disarm the detectors by schedule. For details, see "6.4 Scheduled Arming and Disarming".

6.1 Single Arming and Disarming

You can arm and disarm the detectors in a single area.

- Step 1 On the hub screen, tap **Area**.
- Step 2 Tap an area, and then select from **Home**, **Away**, **Disarm**, and **Disable** in the pop-up window.
- **Home:** An arming mode that allows you to arm the system when inside the area of the alarm system.
 - **Away:** Arm the system when you leave the area of the alarm system.
 - **Disarm:** Turn the security system off. The opposite of arming.
 - **Disable:** Close the current screen.

6.2 Global Arming and Disarming

Prerequisites

Make sure that you have enabled the **Global Arming/Disarming** function. On the hub screen, select  > **Hub Setting**, and then enable **Global Arming/Disarming**.

Background Information

You can arm and disarm the detectors in all the areas.

Procedure

- Step 1 Go to the hub screen.
- Step 2 Select from **Home**, **Away**, and **Disarm** on the upper screen.

6.3 Manual Arming and Disarming

You can arm the security system through the DMSS app or keyfob.

- To arm and disarm the detectors in a single area or all the areas, see "6.1 Single Arming and Disarming", and "6.2 Global Arming and Disarming".
- To operate through the keyfob and keypad, you need to assign the control permissions of the areas to the keyfob and keypad first. For details, see the user's manual of the corresponding keyfob and keypad.

6.4 Scheduled Arming and Disarming

You can set a schedule to arm and disarm detectors. You can configure arming plans, including arming area, modes and periods.

Step 1 On the hub screen, select  > **Hub Setting** > **Scheduled Arming/Disarming**.

Step 2 On the **Scheduled Arming/Disarming** screen, tap **Add**, and then configure arming plans.

- **Name:** Customize a name for the arming plans.
- **Area:** Select a single or multiple areas that you want to arm.
- **Command Setting:** Select from **Home**, **Away**, and **Disarm**.
- **Time:** Set an arming time.



To apply the arming time to other days, tap **Repeat** and select the days you want.

- **Forced Arming:** Select as needed.

Appendix 1 Arming Failure Events and Description

Appendix Table 1-1 Arming failure events and description (accessories)

No.	Reason	Description
1	ModuleLoss	The accessory was offline.
2	HeartError	No heartbeat packets have been sent for more than 18 minutes.
3	Alarm	Alarm (24 hours).
4	Open	The back cover of the device was open.
5	exOpen	The back cover of the external device was open.
6	Tamper	Accessory tamper alarm was triggered.
7	LowBattery	Low battery of the device was detected.
8	PriPowerLoss	Accessory main power failure was detected.
9	BatteryLoss	Battery failure was detected.
10	OverVoltage	Overvoltage was detected.
11	OverCurrent	Overcurrent was detected.
12	OverHeat	Overheat was detected.
13	FireAlarm	Fire alarm was triggered.
14	MedicalAlarm	Medical alarm was triggered.
15	SOSAlarm	SOS alarm was triggered.
16	PanicAlarm	Panic alarm was triggered.
17	GasAlarm	Gas leak alarm was triggered.
18	IntrusionAlarm	Intrusion alarm was triggered.
19	HoldUpAlarm	Panic alarm was triggered.

Appendix Table 1-2 Arming failure events and description (hub)

No.	Reason	Description
1	SOSAlert	Panic alarm can be triggered through the DMSS app.
2	Tamper	Alarm hub tamper alarm was triggered.
3	Server Connect Error	The hub was offline.
4	SIAServer Connect Error	There is an error with the connection between the hub and the SIA alarm receiving center.
5	LowBattery	Low battery was detected.
6	MainLoss	Main power failure was detected.
7	BatteryLoss	Battery failure was detected.

No.	Reason	Description
8	NoGSM	2G/4G module errors was detected.
9	ATS Fault	Alarm transmission system fault was detected.
10	Cellular Network ATP Fault	Alarm transmission path fault (Cellular network failure) was detected.
11	Wired Network/Wi-Fi ATP Fault	Alarm transmission path fault (Wireless or Wi-Fi network failure) was detected.

Appendix 2 SIA Event Codes and Description

Appendix Table 2-1 SIA event codes and description

No.	Event	CID Code	Description
1	Movement Alarm	130 133 134	130: Burglary Alarm. 133: 24 Hour (Safe) Alarm. 134: Entry/Exit Alarm.
2	Door Detector Alarm Restore	130 133 134	130: Burglary Alarm. 133: 24 Hour (Safe) Alarm. 134: Entry/Exit Alarm.
3	External Input Alarm Restore	130 133 134	130: Burglary Alarm. 133: 24 Hour (Safe) Alarm. 134: Entry/Exit Alarm.
4	Duress Alarm	121	Duress Alarm.
5	SOS Alarm	120	Panic Alarm.
6	Intrusion Alarm	130 133 134	130: Burglary Alarm. 133: 24 Hour (Safe) Alarm. 134: Entry/Exit Alarm.
7	Fire Alarm	110	Fire Alarm.
8	Gas Leak Alarm	151	Gas detected Alarm.
9	Medical Alarm	100	Medical Alarm.
10	Hold-up Alarm	120	Panic Alarm.
11	Controller Tamper Resolved	137	Tamper.
12	Peripheral Tamper Resolved	383	Sensor tamper.
13	External Device Tamper Resolved	383	Sensor tamper.
14	Battery Voltage Restored	302	Low system battery.
15	Battery Fault Recovery	311	Battery Missing/Dead.
16	Power Restored	301	AC Loss.
17	RF Jamming	344	RF Receiver Jam Detect.
18	Alarm Transmission System Fault Restored	350	Communication trouble.
19	Alarm Transmission Path Fault Restored/Wi-Fi Errors Recovery	350	Communication trouble.

No.	Event	CID Code	Description
20	Alarm Transmission Path Fault Restored/Wireless Network Errors Recovery	350	Communication trouble.
21	Peripheral Not Connected Restored	381	Loss of supervision - RF.
22	Peripheral Low Battery Alarm Recovery	302	Low system battery.
23	Peripheral Battery Fault Recovery	311	Battery Missing/Dead.
24	Peripheral Main Power Failure Restored	301	AC Loss.
25	RF-HD Fault Restored	354	Failure to communicate event.
26	Device Locked and Unlocked	501	Access reader disable.
27	Overvoltage Protection Restored	319	Power Supply Overvoltage.
28	Overcurrent Protection Restored	312	Power Supply Overcurrent.
29	Overheat Protection Restored	318	Power Supply Overheat.
30	High Temperature Alarm Restored	158	High temp.
31	Low Temperature Alarm Restored	159	Low temp.
32	Arm	400 (App) 401 (Keypad) 403 (Scheduled arming) 407 (Keyfob) 408 (Global arming)	400: Open/Close. 401: O/C by user. 403: Automatic O/C. 407: Remote arm/disarm. 408: Quick arm.
33	Disarm	400 (App) 401 (Keypad) 403 (Scheduled arming) 407 (Keyfob) 408 (No password arming)	400 Open/Close. 401 O/C by user. 403 Automatic O/C. 407 Remote arm/disarm. 408 Quick arm.
34	Home Arming	441	Armed STAY.

No.	Event	CID Code	Description
35	Arming Failure	454 (Arming failure) 455 (Scheduled arming failure) 457 (Exit delay arming failure)	454 Failed to Close. 455 Auto-arm Failed. 457 Exit Error (user).
36	Forced Arming	450	Exception O/C.
37	Peripheral Disable Recovery	502	Temporarily deactivated.
38	Only Disable Tamper Alarm Recovery	503	Temporarily disabled.
39	Manual Test Report	601	Manual trigger test report.

Appendix 3 Cybersecurity Recommendations

Cybersecurity is more than just a buzzword: it's something that pertains to every device that is connected to the internet. IP video surveillance is not immune to cyber risks, but taking basic steps toward protecting and strengthening networks and networked appliances will make them less susceptible to attacks. Below are some tips and recommendations from Dahua on how to create a more secured security system.

Mandatory actions to be taken for basic device network security:

1. Use Strong Passwords

Please refer to the following suggestions to set passwords:

- The length should not be less than 8 characters.
- Include at least two types of characters; character types include upper and lower case letters, numbers and symbols.
- Do not contain the account name or the account name in reverse order.
- Do not use continuous characters, such as 123, abc, etc.
- Do not use overlapped characters, such as 111, aaa, etc.

2. Update Firmware and Client Software in Time

- According to the standard procedure in Tech-industry, we recommend to keep your device (such as NVR, DVR, IP camera, etc.) firmware up-to-date to ensure the system is equipped with the latest security patches and fixes. When the device is connected to the public network, it is recommended to enable the "auto-check for updates" function to obtain timely information of firmware updates released by the manufacturer.
- We suggest that you download and use the latest version of client software.

"Nice to have" recommendations to improve your device network security:

1. Physical Protection

We suggest that you perform physical protection to device, especially storage devices. For example, place the device in a special computer room and cabinet, and implement well-done access control permission and key management to prevent unauthorized personnel from carrying out physical contacts such as damaging hardware, unauthorized connection of removable device (such as USB flash disk, serial port), etc.

2. Change Passwords Regularly

We suggest that you change passwords regularly to reduce the risk of being guessed or cracked.

3. Set and Update Passwords Reset Information Timely

The device supports password reset function. Please set up related information for password reset in time, including the end user's mailbox and password protection questions. If the information changes, please modify it in time. When setting password protection questions, it is suggested not to use those that can be easily guessed.

4. Enable Account Lock

The account lock feature is enabled by default, and we recommend you to keep it on to guarantee the account security. If an attacker attempts to log in with the wrong password several times, the corresponding account and the source IP address will be locked.

5. Change Default HTTP and Other Service Ports

We suggest you to change default HTTP and other service ports into any set of numbers between

1024–65535, reducing the risk of outsiders being able to guess which ports you are using.

6. **Enable HTTPS**

We suggest you to enable HTTPS, so that you visit Web service through a secure communication channel.

7. **MAC Address Binding**

We recommend you to bind the IP and MAC address of the gateway to the device, thus reducing the risk of ARP spoofing.

8. **Assign Accounts and Privileges Reasonably**

According to business and management requirements, reasonably add users and assign a minimum set of permissions to them.

9. **Disable Unnecessary Services and Choose Secure Modes**

If not needed, it is recommended to turn off some services such as SNMP, SMTP, UPnP, etc., to reduce risks.

If necessary, it is highly recommended that you use safe modes, including but not limited to the following services:

- SNMP: Choose SNMP v3, and set up strong encryption passwords and authentication passwords.
- SMTP: Choose TLS to access mailbox server.
- FTP: Choose SFTP, and set up strong passwords.
- AP hotspot: Choose WPA2-PSK encryption mode, and set up strong passwords.

10. **Audio and Video Encrypted Transmission**

If your audio and video data contents are very important or sensitive, we recommend that you use encrypted transmission function, to reduce the risk of audio and video data being stolen during transmission.

Reminder: encrypted transmission will cause some loss in transmission efficiency.

11. **Secure Auditing**

- Check online users: we suggest that you check online users regularly to see if the device is logged in without authorization.
- Check device log: By viewing the logs, you can know the IP addresses that were used to log in to your devices and their key operations.

12. **Network Log**

Due to the limited storage capacity of the device, the stored log is limited. If you need to save the log for a long time, it is recommended that you enable the network log function to ensure that the critical logs are synchronized to the network log server for tracing.

13. **Construct a Safe Network Environment**

In order to better ensure the safety of device and reduce potential cyber risks, we recommend:

- Disable the port mapping function of the router to avoid direct access to the intranet devices from external network.
- The network should be partitioned and isolated according to the actual network needs. If there are no communication requirements between two sub networks, it is suggested to use VLAN, network GAP and other technologies to partition the network, so as to achieve the network isolation effect.
- Establish the 802.1x access authentication system to reduce the risk of unauthorized access to private networks.
- Enable IP/MAC address filtering function to limit the range of hosts allowed to access the

device.

More information

Please visit Dahua official website security emergency response center for security announcements and the latest security recommendations.

ENABLING A SAFER SOCIETY AND SMARTER LIVING

ZHEJIANG DAHUA VISION TECHNOLOGY CO., LTD.

Address: No.1199 Bin'an Road, Binjiang District, Hangzhou, P. R. China | Website: www.dahuasecurity.com | Postcode: 310053

Email: overseas@dahuatech.com | Fax: +86-571-87688815 | Tel: +86-571-87688883