



3570 Series Cylinder Mortice Locks



ASSA ABLOY

ASSA ABLOY, the global leader
in door opening solutions

Contents

3570 General Information	1
3570 Features	2
3570 Nightlatches	4-5
3571 Deadlocks	6-7
3572 Vestibule Locks	8-11
3573 Sliding Door Deadlocks	12-13
3574 Combination Latches	14-15
3577 Dual Entry Deadlatch	16
3578 Hold Back Deadlatches	17
3579 Series SCEC Secure Area	18
3670 Securafix Series	19
3570 Accessories	20-21
3570 Cylinder Cam and Adaptors Chart	22
3570 Cam/Adaptor Function Chart	23
3570 Ordering Procedure	24

Application

A wide range of security cylinder mortice locks and latches suitable for heavy duty use in industrial and commercial buildings, institutions, clubs, schools, hospitals, hotels and similar buildings.

Features & Specifications

All 3570 Series cylinder mortice locks are made from quality materials to meet high durability and strength requirements.

Case & Cover Plates:

- High purity zinc alloy material cases and stainless steel cover plates
- Brass plates provided for plated finishes available in square and round end

Backset:

- 60mm standard backset
- Extended backsets 89 and 127mm are available on application. (Refer to Ordering Procedure)

Latchbolts

Latchbolts are 15mm, stainless steel. Deadlatching is achieved by an auxiliary stainless steel latchbolt. This auxiliary bolt retracts when the main latchbolt is withdrawn when the door is closed.

Deadbolts

Deadbolts are 19mm, stainless steel.

Springs

High-grade spring steel material, corrosion protected.

Cylinder Retaining Pin

Hard-drawn spring steel wire, corrosion protected.

Door Thickness

- 3570 Series locks - 32 to 50mm
- 3579 Series SCEC locks - 35 to 50mm
- 3670 Series Securafix locks - 32 to 45mm

Locksets to suit thicker doors are available on application.

Cylinder

Five pin tumbler mechanism. Standard Lockwood oval shaped brass cylinders and brass plugs.

Door Clearance

To ensure correct functioning of the deadlatching mechanism and security for all locks, the clearance between the door and frame should be 3mm. However the deadlatching will operate up to 8mm door clearance.

Aluminium Doors

Aluminium door accessory packs and aluminium fix locks are available upon request. Specify

SP3570 - 419 for mounting tabs accessory pack or 3572AFSC for complete primary lock.

Security

All 3570 Series Cylinder Mortice Locks conform with Level S2 (Physical Security) Australian Lock Standard (AS-4145.2-1993). Level S3 (Physical Security) is available upon request.

Durability

All 3570 Series Cylinder Mortice Locks conform with level D3 (Durability) Australian Lock Standard (AS 4145.2-1993).

Fire rating

Lockwood 3570 Series Mortice Locks have been successfully tested up to 4 Hours (depending on type of doorset) on fire door assemblies in accordance with Australian Standard AS 1905.1-2005, Part 1: Fire resistant doorsets.

Keying

Standard keying:

- Supplied individually keyed with two keys per lock and 78,000 random key combinations.
- Key blank KB2015P.

Special Keying

Can be keyed alike, master keyed, grand master keyed, maison keyed or construction keyed in Lockwood security keying systems.

Standard Finishes

Chrome Plate	CP
Satin Chrome	SC
Polished Brass	PB

Specification Service

For all architectural hardware specification assistance refer to your local ASSA ABLOY Sales Office. A fully comprehensive, obligation free, architectural door hardware specification can be prepared by ASSA ABLOY Architectural Hardware Consultants.

Extended Cylinders

Extended cylinders are available for thicker doors - refer Accessories on page 21.

Rebate

Rebate kits to suit 13mm standard rebate are available - refer Accessories on page 20.

Electric Strikes

Lockwood 3570 Series Mortice Locks are compatible with most electric strikes. Refer local sales office for further details.

S2 HIGH SECURITY

D3 DURABILITY

FIRE RATED



ASSA ABLOY

3570 Series Cylinder Mortice Locks

3570 Series Standard Backset

1. Hub Selection

A patent protected cam operated hub setting mechanism accessible through the lock body from the outside.

2. Latch Bolt

Reversible for both left and right hand doors opening in or opening out without disassembly.

Standard deadlatch configuration, except for passage latch function.

Separate auxiliary bolt moves into lock case simultaneously with latch bolt.

Bolt – stainless steel fire rated to 4 hours as standard. Electric strike compatible.

3. Strike

Universal stainless steel strike suitable for 4 hour fire rating applications.

4. Door Thickness

Standard applications 32 to 50mm.

5. Backsets

60mm standard, 89mm and 127mm available on application.

6. Cylinder/Adaptor Retention

Patented “Slip Pin” Cylinder/Adaptor fixing method, which allows attachment to the case by inserting a non-threaded cylindrical pin through the front of the lock case.

7. Multi-Function Lock

Lock is designed to significantly reduce stock line items.

Standard cylinder mortice lock can be converted from escape function to combination function by simple adjustment of hub snibs without lock case disassembly.

8. Case Assembly

High purity zinc alloy case and backplate.

9. Cylinder Assembly

Five pin tumbler mechanism. Standard Lockwood oval shaped, brass cylinders and brass plugs.

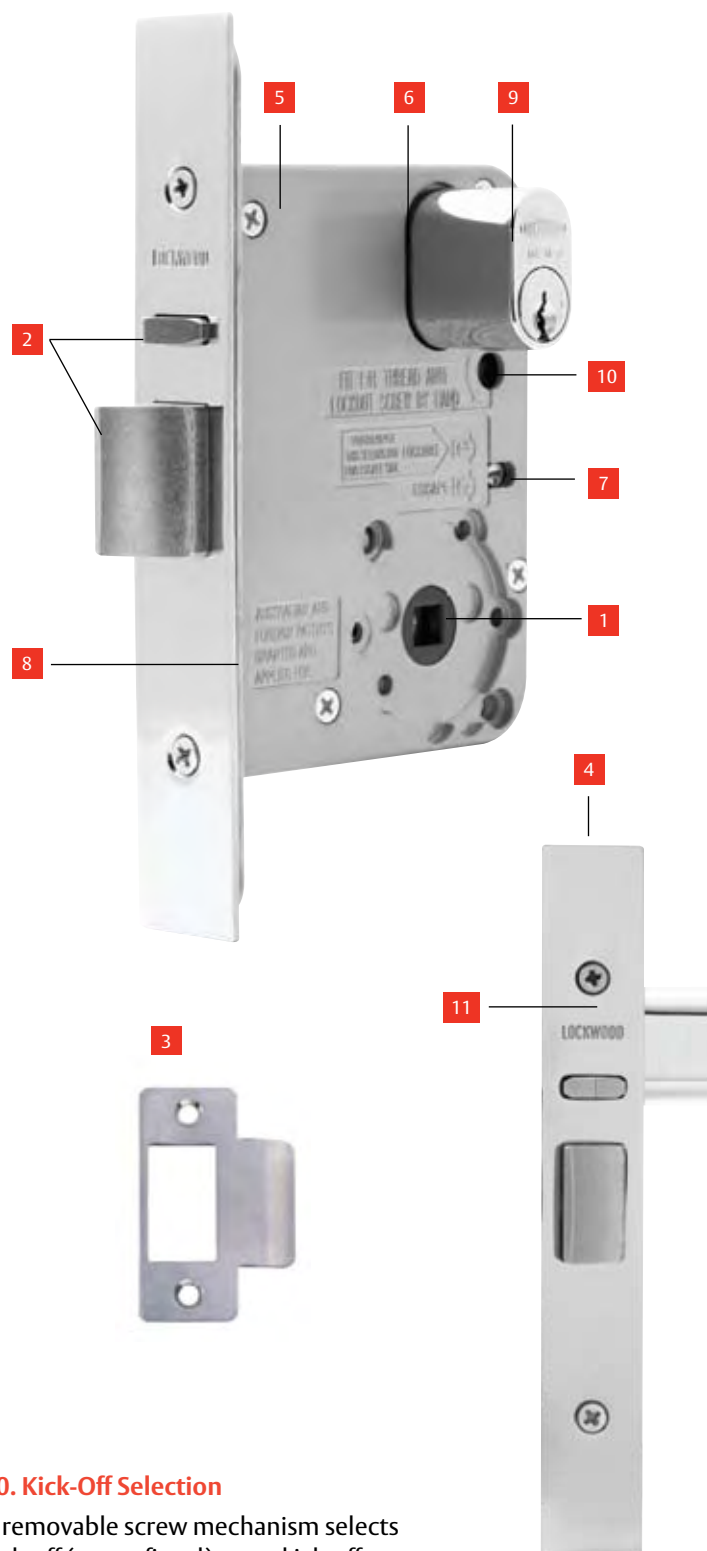

10. Kick-Off Selection

A removable screw mechanism selects kick-off (screw fitted) or no kick-off (screw removed).

11. Faceplate

Stainless steel face plate supplied in square end (standard) and optional round end.



3570 Series Cylinder Mortice Locks

3570 Nightlatches

Various latching functions operated by a key outside and by a turnknob or key inside. The nightlatch locks automatically when the door is closed.

For all nightlatch functions specify the primary lock (3570SC). This lock can then be easily adapted to suit function required.

Features & Specifications

Bolt

Deadlatch only.

Furniture

Compatible with all Lockwood cylinder escutcheons, turnknobs and plate furniture.

Keying

Can be keyed alike, master keyed, grand master keyed, maison keyed or construction keyed in Lockwood security keying systems.

Standard Finishes:

Chrome Plate CP
Satin Chrome SC
Polished Brass PB
Other finishes on application.

Ordering Procedure

Refer page 24.

Dimensions

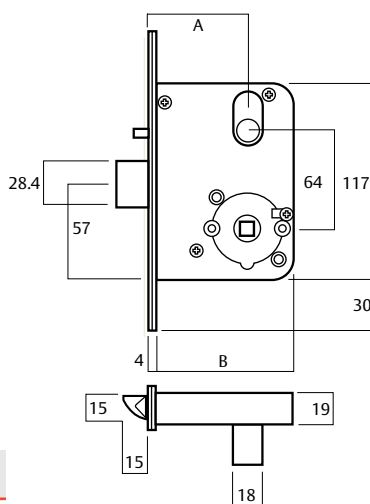
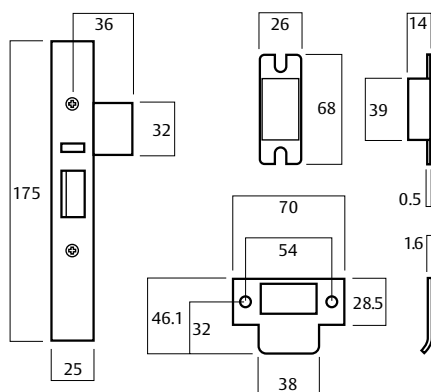

	STD Backset	Extended backset
Dimension A	60	127
Dimension B	84	151

1300 LOCK UP (1300 562 587)
lockweb.com.au

3570 Nightlatches

Nightlatch

Cylinder and turnknob. Reversible.

Right hand 3570XTR

Left hand 3570XTL

Outside: Opened by key.

Inside: Opened by turnknob.

Communicating Door Latch

Double Cylinder. Reversible.

Non-handed 3570XX

Outside: Opened by key.

Inside: Opened by key.

Exit Door Latch

Double Cylinder. Reversible.

Right hand 3570-TR

Left hand 3570-TL

Inside: Opened by turnknob.

Cylinder Latch

Single cylinder. Reversible

Right hand 3570X-R

Left hand 3570X-L

Lockset may be installed with cylinder either inside or outside.

Outside/Inside: Opened by key

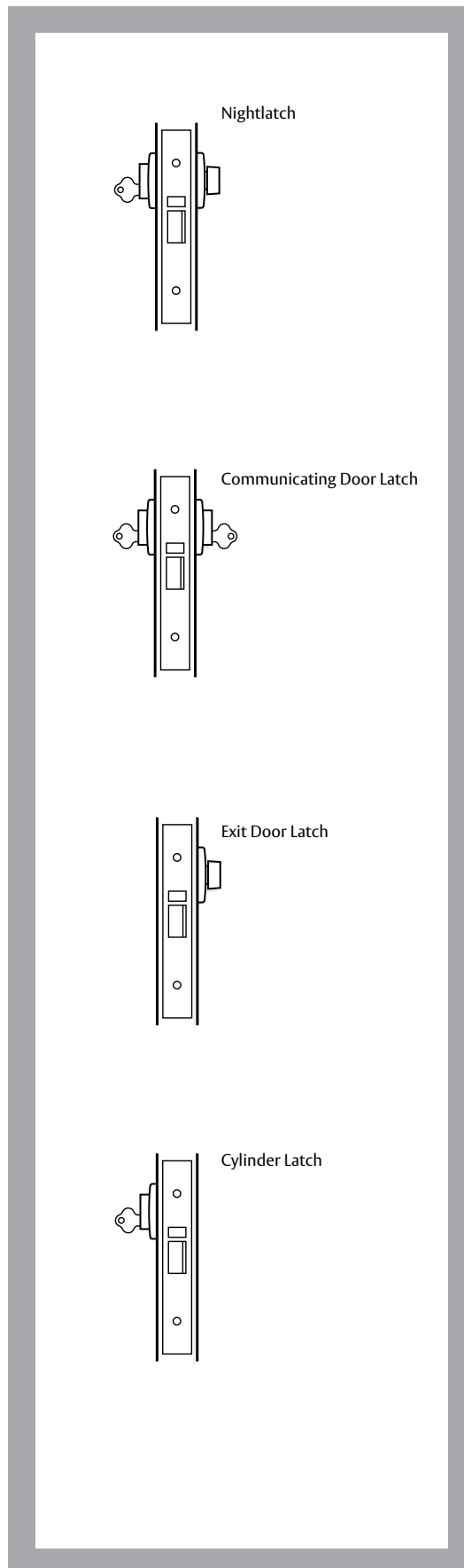

ASSA ABLOY

3570 Series Cylinder Mortice Locks

3571 Deadlocks

Various deadlocking functions operated generally by a key outside and by a turnknob or key inside. Locked by key or turnknob when the door is closed.

For all deadlock functions specify primary lock (3571SC). This lock can then be easily adapted to suit function required.

Features & Specifications

Bolt

19mm stainless steel bolt.

Furniture

Compatible with all Lockwood cylinder escutcheons, turnknobs and plate furniture.

Keying

Can be keyed alike, master keyed, grand master keyed, maison keyed or construction keyed in Lockwood security keying systems.

Standard Finishes:

Chrome Plate CP
Satin Chrome SC
Polished Brass PB
Other finishes on application.

Ordering Procedure

Refer page 24.

Dimensions

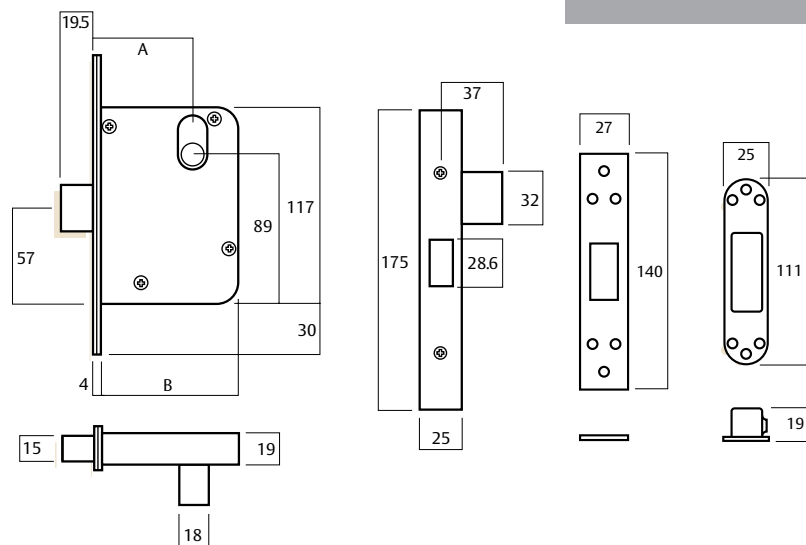

	STD Backset	Extended backset	
Dimension A	60	89	127
Dimension B	84	113	151

3571 Deadlocks

Nightlatch

Cylinder and turnknob. Reversible.

3571WT

Outside: Locked or unlocked by key.

Inside: Locked or unlocked by turnknob.

Communicating Door Latch

Double Cylinder. Reversible.

3571YY

Outside: Locked or unlocked by key.

Inside: Locked or unlocked by key.

Exit Door Latch

Turnknob inside. Reversible.

3571-T

Inside: Locked or unlocked by turnknob.

Lockup Shop Deadlock

Single cylinder. Reversible.

3571Y

Lockset may be installed with cylinder either inside or outside.

Outside/Inside: Locked or unlocked by key

Escape Deadlock

Cylinder and escape lever.

Left hand 3571DEL

Right hand 3571DER

Outside: Locked or unlocked by key.

Inside: Unlocked only by escape turn. Inside turn will not lock door.

Through Fix Privacy Deadlock

**Emergency Turn knob Escutcheon.
Turn knob. Reversible.**

3571PT

Outside: Operated by coin or screwdriver in emergency situation by operating the slotted emergency turn button.

Inside: Locked or unlocked by turn knob.

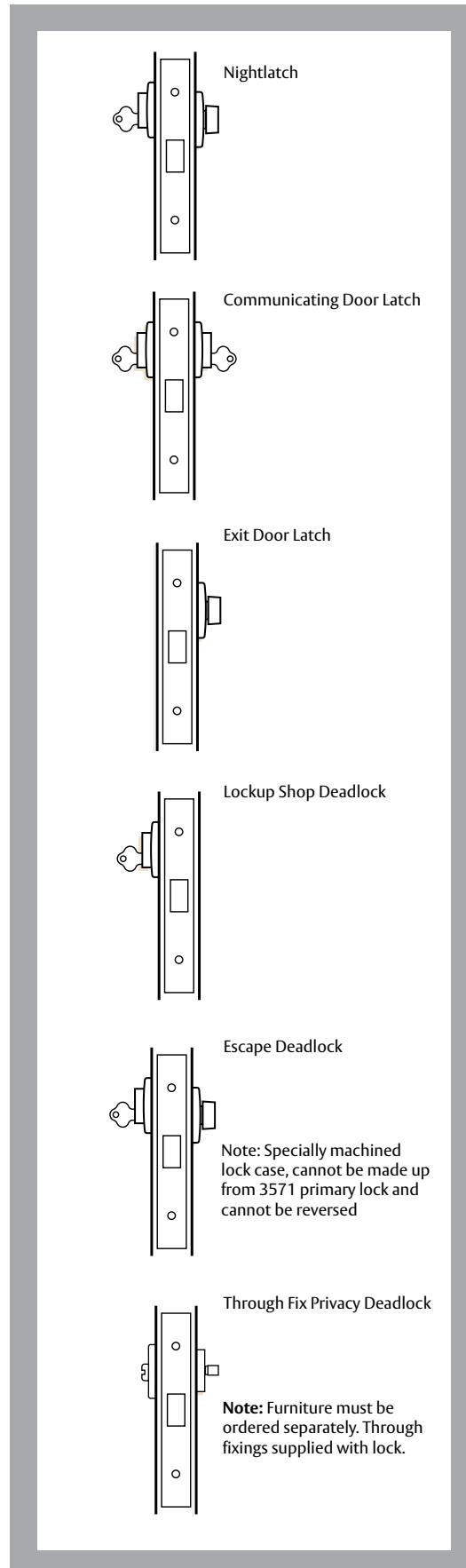

ASSA ABLOY

3570 Series Cylinder Mortise Locks

3572 Vestibule Locks

These locks have various latching functions which can be operated by key or handle outside and by turnknob, key or handle inside.

For ease of selection specify primary lock (3572SC). This lock can then be easily adapted to suit function required.

These locks have various latching functions which can be operated by key or by a handle inside.

Features & Specifications

Bolt

Deadlatch only.

Furniture

Compatible with all Lockwood rose and plate furniture including Brass Door Furniture, Daintree, Aquileart, Artefact Series II and Ovation series

Keying

Can be keyed alike, master keyed, grand master keyed, maison keyed or construction keyed in Lockwood security keying systems.

Aluminium Doors

Aluminium door accessory packs and aluminium fix locks are available upon request. Specify SP3570 - 419 for mounting tabs accessory pack or 3572AFSC for complete primary lock.

Standard Finishes

Chrome Plate	CP
Satin Chrome	SC
Polished Brass	PB

Other finishes on application.

Ordering Procedure

Refer page 24.

Dimensions

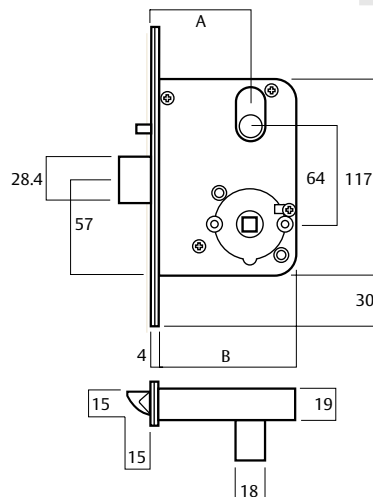
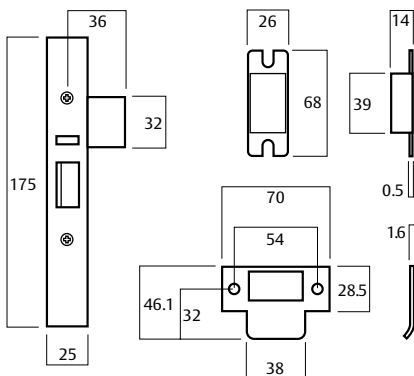

	STD Backset	Extended backset	
Dimension A	60	89	127
Dimension B	84	113	151

1300 LOCK UP (1300 562 587)
lockweb.com.au

Storeroom Locking Latch

Cylinder outside. Reversible.

Right hand 3572X-R

Left hand 3572X-L

Outside: Opened by key. Handle is always rigid.

Inside: Opened by handle at all times.

Single Action Escape Latch

Cylinder outside. Reversible

Right hand 3572X-R

Left hand 3572X-L

Outside: Opened by key.

Inside: Opened by handle at all times.

Classroom & Office Locking Latch

Cylinder outside. Reversible.

Right hand 3572Z-R

Left hand 3572Z-L

Outside: Opened by handle except when handle is made inoperative by key from outside. Key locks or unlocks outside handle.

Inside: Opened by handle at all times.

Antilockout Privacy Escape Latch

Emergency button and turn knob. Handed.

Right hand 3572EAR

Left hand 3572EAL

Outside: Opened by handle except when handle is made inoperative by turn knob from inside. Handle may be unlocked from outside by coin or screwdriver by operating the slotted emergency button.

Inside: Opened by handle at all times. Turn knob locks or unlocks outside handle.

Antilockout: Closing the door or operation of inside handle will "kick-off" the locking feature, allowing the outside handle to become operative.

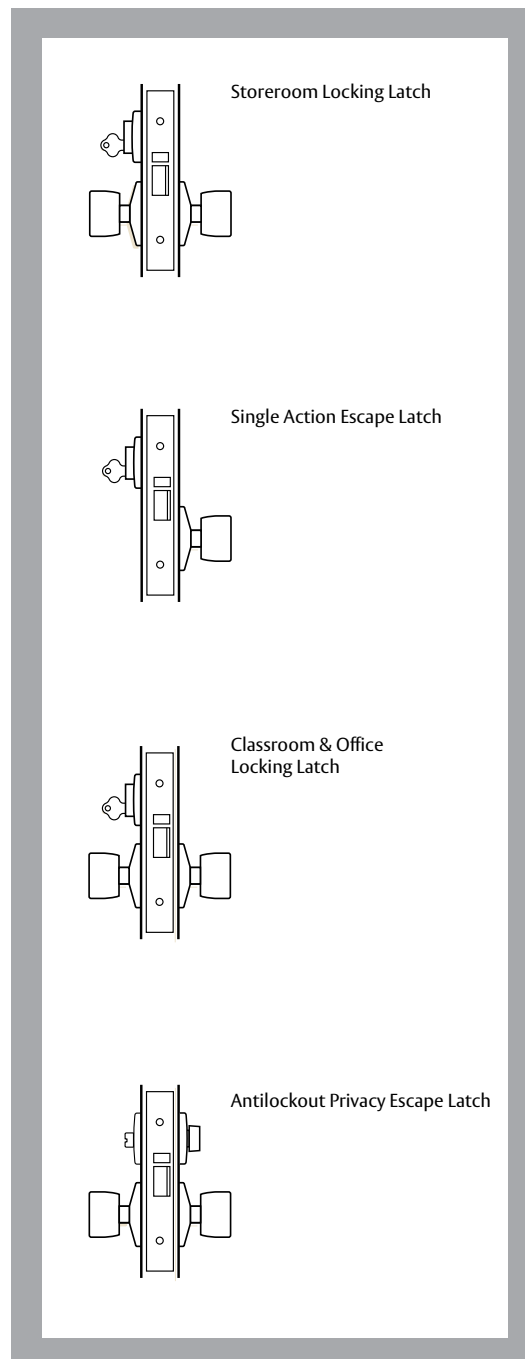

3570 Series Cylinder Mortice Locks

3572 Vestibule Locks

Antilockout Entry Door Lock

Cylinder and turnknob. Handed.

Right hand	3572XAR
Left hand	3572XAL

Outside: Opened by key at all times. Opened by handle except when handle is made inoperative by key from outside or turnknob from inside.

Inside: Opened by handle at all times. Turnknob locks or unlocks outside handle.

Antilockout: Latching the bolt by key, closing the door or operation of inside handle will “kick-off” the locking feature, allowing the outside handle to become operative.

Classroom & Office Locking/Latching Latch

Locking/Latching cylinder outside. Handed.

Right hand	3572M-R
Left hand	3572M-L

Outside: Opened by handle except when handle is made inoperative by key from outside. Key locks or unlocks outside handle.

Inside: Open by handle at all times.

Antilockout Vestibule Set

Cylinder and turnknob. Handed.

Right hand	3572WAR
Left hand	3572WAL

Outside: Opened by handle except when handle is made inoperative by key from outside. Key locks or unlocks outside handle.

Inside: Open by handle at all times.

Antilockout: Closing the door or operation of inside handle will “kick-off” the locking feature, allowing the outside handle to become operative.

Vestibule Set

Cylinder and turnknob. Reversible.

Right hand	3572XTR
Left hand	3572XTL

Outside: Opened by handle except when handle is made inoperative by turn knob from inside. Handle may be unlocked from outside by coin or screwdriver by operating the slotted emergency button.

Inside: Opened by handle at all times. Turn knob locks or unlocks outside handle.

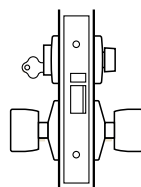

Antilockout Entry Door Lock

Notes: a) Latchbolt can be retracted by key if handle has been rendered inoperative. b) Specially machined lock case, cannot be made up from 3572 primary lock.

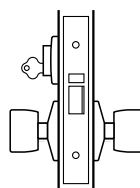

Classroom & Office Locking/Latching Latch

Note: Lock contains special adaptor to enable latch bolt to be retracted by key if handle has been rendered inoperative.

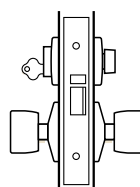

Antilockout Vestibule Set

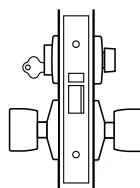

Vestibule Set

3572 Vestibule Locks

Exit Door Latch

Exit function only. Reversible.

Right hand	3572R
Left hand	3572L

Outside: Handle is always rigid.
Inside: Opened by handle at all times.

Exterior & Exit Door Lock

Double cylinder. Reversible.

Right hand	3572XZR
Left hand	3572XZL

Outside: Opened by key at all times. Opened by handle except when handle is made inoperative by key from inside.
Inside: Opened by handle at all times. Key locks or unlocks outside handle.

Exterior & Exit Door Lock

Cylinder inside. Reversible.

Right hand	3572-ZR
Left hand	3572-ZL

Outside: Opened by handle except when handle is made inoperative by key from inside.
Inside: Opened by handle at all times. Key locks or unlocks outside handle.

Exterior & Exit Door Lock

Turnknob inside. Reversible.

Right hand	3572-TR
Left hand	3572-TL

Outside: Opened by handle except when handle is made inoperative by turnknob from inside.
Inside: Opened by handle at all times. Turnknob locks or unlocks outside handle.

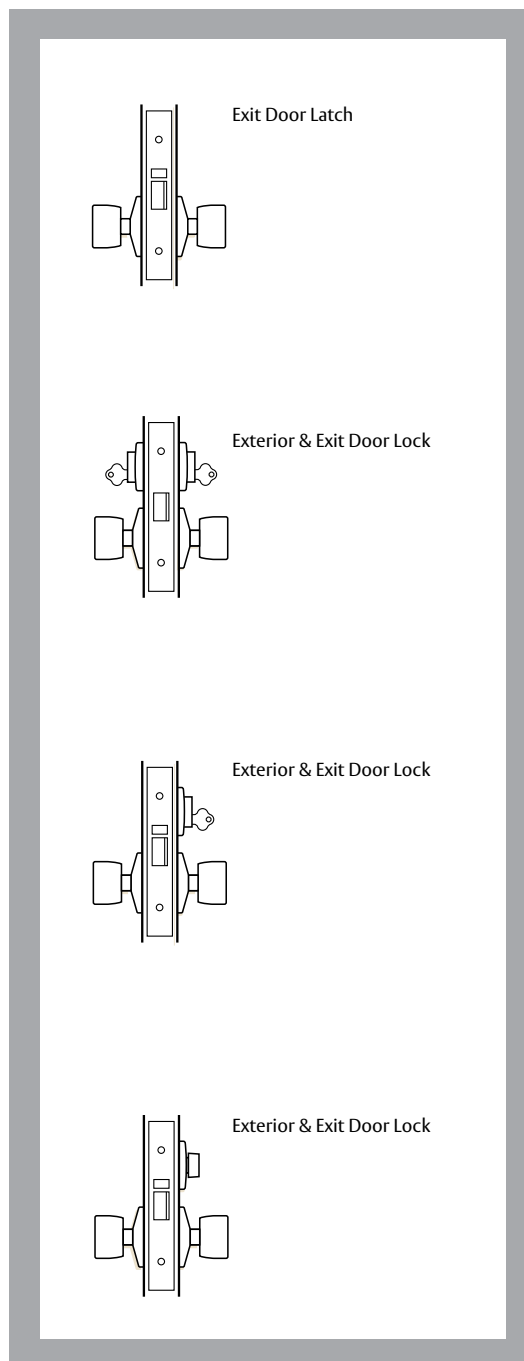

3570 Series Cylinder Mortise Locks

3573 Sliding Door Deadlocks

Various deadlocking functions operated generally by key outside and by turnknob or key inside. Locked by key or turnknob when door is closed.

For all sliding door deadlock functions specify primary lock (3573SC). This lock can then be easily adapted to suit function required.

Features & Specifications

Bolt

Deadlock.

Furniture

Compatible with all Lockwood cylinder escutcheons, turnknobs and plate furniture.

Keying

Can be keyed alike, master keyed, grand master keyed, maison keyed or construction keyed in Lockwood security keying systems.

Standard Finishes

Chrome Plate	CP
Satin Chrome	SC
Polished Brass	PB

Other finishes on application.

Ordering Procedure

Refer page 24.

Dimensions

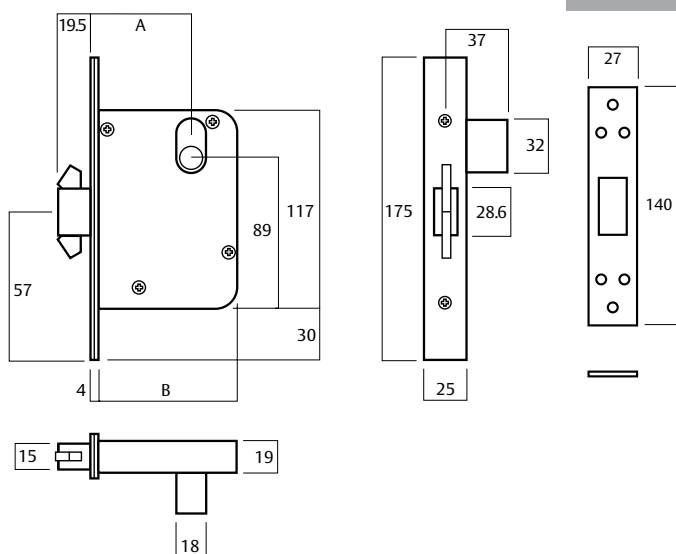

	STD Backset	Extended backset	
Dimension A	60	89	127
Dimension B	84	113	151

3573 Sliding Door Deadlocks

Sliding Door Deadlock

Exit function only. Reversible.

3573WT

Outside: Locked or unlocked by key.

Inside: Locked or unlocked by turnknob.

Sliding Glass Door Deadlock

Double cylinder. Reversible.

3573YY

Recommended for glass doors.

Outside: Locked or unlocked by key.

Inside: Locked or unlocked by key.

Exit Sliding Door Deadbolt

Turnknob inside. Reversible.

3573-T

Inside: Locked or unlocked by turnknob.

Lockup Shop Sliding Door Deadlock

Single cylinder. Reversible.

3573Y-

Outside: Locked or unlocked by key.

Inside: Unlocked only by escape turn.

Sliding Door Escape Deadlock

Cylinder and escape lever.

Right hand 3573DEL

Left hand 3573DER

Outside: Locked or unlocked by key.

Inside: Unlocked only by escape turn. Inside turn will not lock door.

Sliding Door Through Fix Privacy Latch

**Emergency Turn knob Escutcheon.
Turn knob. Reversible.**

3573PT

Outside: Locked or unlocked by key.

Inside: Unlocked only by escape turn.

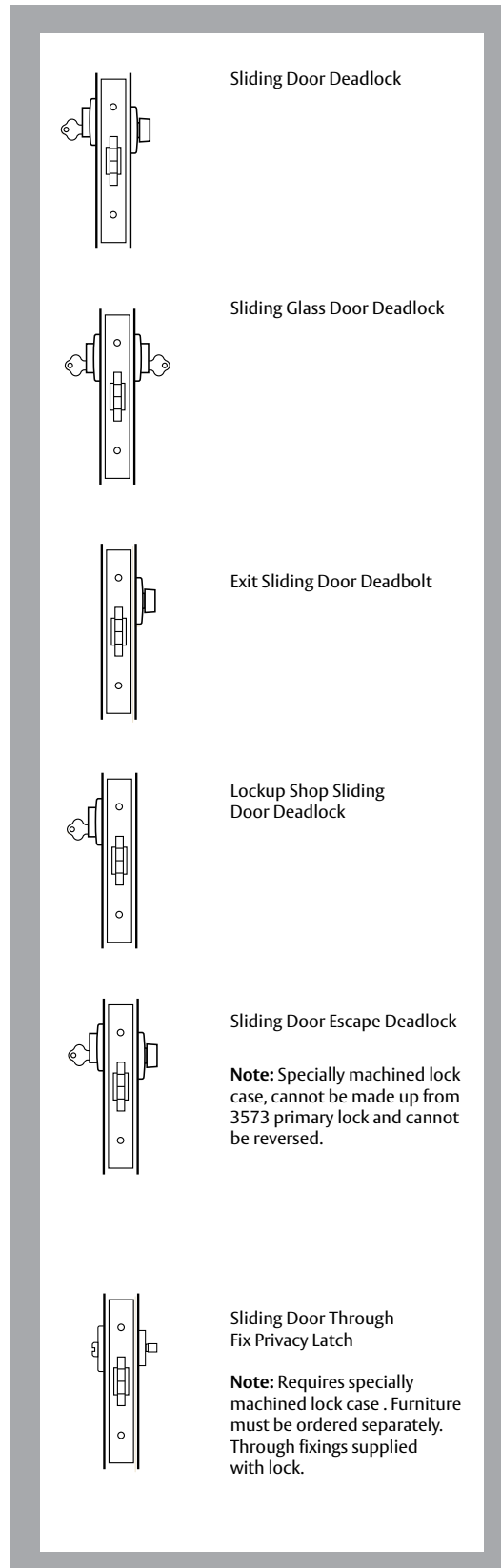

3570 Series Cylinder Mortise Locks

3574 Combination Latches

Various latching functions operated generally by outside or inside handles, except when locked by key outside or by key or turnknob inside.

For ease of selection specify primary lock (3572SC). This lock can then be easily adapted to function required.

Note: Passage set available with plainlatch only (3574SC).

Features & Specifications

Bolt

Deadlatch only.

Furniture

Compatible with all Lockwood rose and plate

furniture including Brass Door Furniture, Daintree, Aquileart, Artefact Series II and Ovation series.

Keying

Can be keyed alike, master keyed, grand master keyed, maison keyed or construction keyed in Lockwood security keying systems.

Standard Finishes

Chrome Plate	CP
Satin Chrome	SC
Polished Brass	PB

Other finishes on application.

Ordering Procedure

Refer page 24.

Dimensions

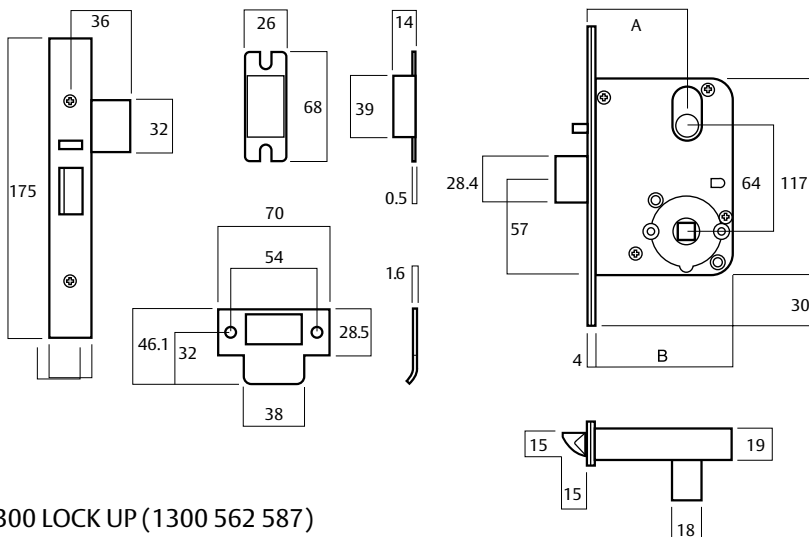

	STD Backset	Extended backset	
Dimension A	60	89	127
Dimension B	84	113	151

1300 LOCK UP (1300 562 587)
lockweb.com.au

3574 Combination Latches

Office Locking Latch

Cylinder and turnknob. Reversible

Right hand	3574WTR
Left hand	3574WTL

Outside: Opened by handle except when handle is made inoperative by key from outside or by turnknob from inside. Key locks or unlocks both handles.
Inside: Opened by handle except when handle is made inoperative by key from outside or turnknob from inside. Turnknob locks or unlocks both handles.

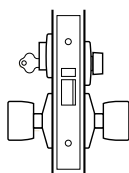

Glass Door Locking Latch

Double cylinder. Non-handed.

3574ZZ

Outside: Opened by handle except when handle is made inoperative by key from either side. Key from either side locks or unlocks both handles.
Inside: Opened by handle except when handle is made inoperative by key from either side. Key from either side locks or unlocks both handles.

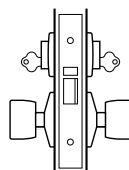

Glass Door Locking Latch

Cylinder outside. Reversible.

Right hand	3574Z-R
Left hand	3574Z-L

Outside: Opened by handle except when handle is made inoperative by key from outside. Key locks or unlocks both handles.
Inside: Opened by handle except when handle is made inoperative by key from outside.

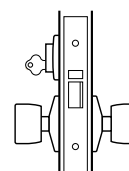

Passage Latch

No locking function. Non-handed. Plainlatch only.

3574

Outside: Opened by handle.
Inside: Opened by handle.

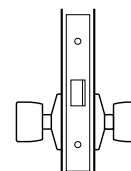

Privacy Latch

Emergency button and turnknob Reversible.

Right hand	3574ETR
Left hand	3574ETL

Outside: Opened by handle except when handle is made inoperative by emergency turnknob from outside or turnknob from inside. Emergency turnknob locks or unlocks both handles.
Inside: Opened by handle except when handle is made inoperative by emergency turnknob from outside or turnknob from inside. Emergency turnknob locks or unlocks both handles.

Antilockout: Closing the door or operation of inside handle will "kick-off" the locking feature, allowing the outside handle to become operative.

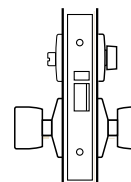

Glass Door Locking Latch

Double cylinder. Reversible.

Right hand	3574XZR
Left hand	3574XZL

Outside: Opened by key at all times. Opened by handle except when handle is made inoperative by key from inside. Key retracts latchbolt.
Inside: Opened by handle except when handle is made inoperative by key from inside. Key locks or unlocks both handles.

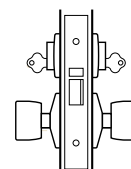

3570 Series Cylinder Mortice Locks

3577 Dual Entry Deadlatch

Designed to enable emergency services to enter specific areas by second cylinder without giving access to all locksets in the building and the ability to lockout keys with restricted access at certain times.

Features & Specifications

Furniture

Select from Lockwood 1800, 2800 or Artefact Series II ranges.

Keying

Can be keyed alike, master keyed, grand master keyed, maison keyed or construction keyed in Lockwood security keying systems.

Standard Finishes

Chrome Plate	CP
Satin Chrome	SC
Polished Brass	PB

Other finishes on application.



Dual Entry Deadlatch

Two cylinders outside. Handle inside. Reversible.

Right hand	3577X-R
Left hand	3577X-L

Outside: Opened by key, cylinders are keyed to differ.
Inside: Opened by handle at all times.

Dual Entry/Key Lockout Deadlatch

Two cylinders outside. Handle inside. Reversible.

Right hand	3577Z-R
Left hand	3577Z-L

Outside: Opened by bottom key. Top key locks and unlock bottom key.
Inside: Opened by handle at all times.

Dual Entry/Key Lockout Latching Latch

Two cylinders outside. Handle inside. Reversible.

Right hand	3577M-R
Left hand	3577M-L

Outside: Opened by bottom key when made operative by top key. Top key locks or unlocks bottom key and retracts latch.
Inside: Opened by handle at all times.

1300 LOCK UP (1300 562 587)
lockweb.com.au

Dimensions

	STD Backset	Extended backset	
Dimension A	60	89	127
Dimension B	84	113	151

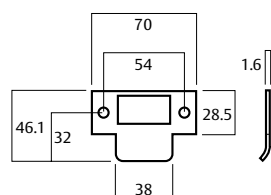
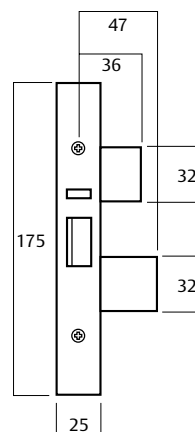
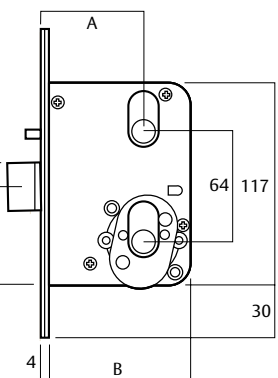
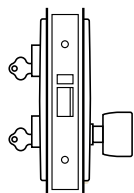
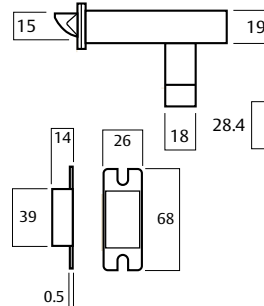
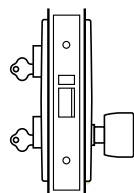

3578 Hold Back Deadlatches

A deadlatching lockset for applications where latch hold back is required such as high use doors and toilet doors.

Features & Specifications

Bolt

Deadlatch

Furniture

Compatible with all Lockwood rose and plate furniture including Brass Door Furniture, Daintree, Aquileart, Artefact Series II and Ovation series.

Keying

Can be keyed alike, master keyed, grand master keyed, maison keyed or construction keyed in Lockwood security keying systems.

Fire Rating

3578 Hold Back deadlatches are non-fire rated.

Standard Finishes

Chrome Plate	CP
Satin Chrome	SC
Polished Brass	PB

Classroom & Office Locking/Latching Latch with Hold Back

Cylinder outside. Reversible.

Right hand	3578Z-R
Left hand	3578Z-L

Outside: Opened by handle except when handle is made inoperative by key from outside. Key locks or unlocks outside handle.

Inside: Open by handle at all times.

Hold Back: Latchbolt held back when latch depressed and key rotated 360°.

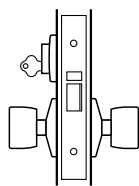

Antilockout Vestibule Set

Cylinder and turnknob. Handed

Right hand	3578WTR
Left hand	3578WTL

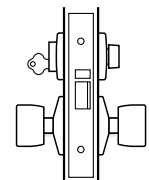

Outside: Opened by handle except when handle is made inoperative by key from outside or turnknob from inside. Key locks or unlocks outside handle.

Inside: Opened by handle at all times. Turnknob locks or unlocks outside handle.

Hold Back: Latchbolt held back when latch depressed and key or turnsnib rotated 90°.

Dimensions

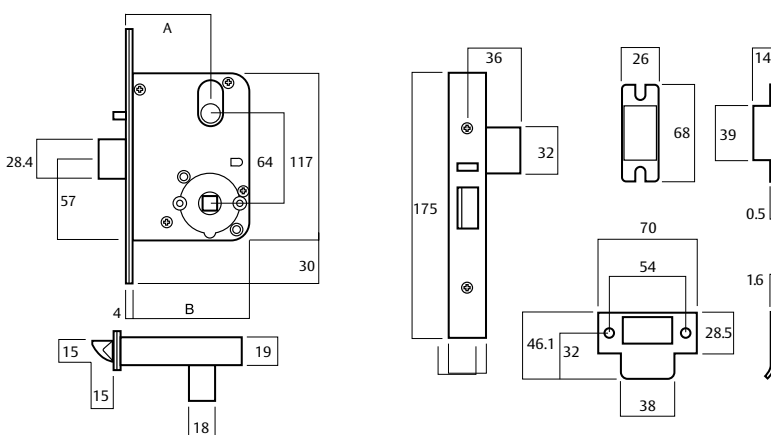

	STD Backset	Extended backset	
Dimension A	60	89	127
Dimension B	84	113	151



3570 Series Cylinder Mortice Locks

3579 Series Mortice Locks and Deadbolts SCEC Endorsed (Secure Area)

For use in high security government, institutional and commercial projects, the 3579 Series Mortice Lock has been successfully SCEC endorsed for secure area applications.

Fire Rating

The Lockwood 3579 Series Cylinder Mortice Lock has been successfully fire tested up to 4 hours on fire door assemblies in accordance with Australian Standard AS 1905.1 - 2005, Part 1: Fire-resistant doorsets.

Features & Specifications

- All handing type features of the lock including hub selection, anti-lockout screw & reversible latch are accessible without removing the plates
- 570 oval type cylinders & retaining pin can be used (cylinder must also be SCEC endorsed for secure area)
- 2 x 1.2mm Stainless steel plates fixed through the lock provide increased strength to the cylinder and latch areas of the lock
- Available with all 3570, 3571, 3572 and 3574 functions (refer to pages 4-11 and 14-15)

To achieve secure area rating, the 3579 Mortice Lock must also:

- Be fitted with a SCEC endorsed 570 oval cylinder which is also Secure Area rated, eg ABLOY PROTEC
- Be fitted with full plate furniture including Lockwood 1800 Series, 2800 Series and Artefact Series II

Furniture

Select from the Lockwood 1800, 2800 or Artefact Series II plate furniture ranges to maintain compliance with SCEC Secure Area ratings.



Functions

Available in Nightlatch, Deadbolt, Vestibule Set and Combination lock configurations - refer to relevant pages within this catalogue for further function detail.

- Nightlatch Functions - pages 4-5
- Deadbolt Functions - pages 6-7
- Vestibule Set Function - pages 8-11
- Combination Lock Functions - pages 14-15

Keying

Can be keyed alike, master keyed, grand master keyed, maison keyed or construction keyed in SCEC Secure Area Endorsed keying systems such as Abloy Protec.

Standard Finishes

Chrome Plate	CP
Satin Chrome	SC
Polished Brass	PB

3670 Securafix Series Patent Pending

Application

Where added security is required a wide range of security cylinder mortice locks are available. Suitable for heavy duty use in industrial and commercial buildings, institutions, clubs, schools, hospitals, hotels and similar buildings.

Fire Rating

The Lockwood 3670 Series Securafix Cylinder Mortice Locks have been successfully fire tested on fire door assemblies up to 4 Hours (depending on type of door) in accordance with the requirements of Australian Standard AS1905.1:2005 Part 1: Fire-resistant doorsets.

Features & Specifications

Case & Cover Plates

High purity zinc alloy material cases and stainless steel cover plates. Brass plates provided for plated finishes.

Backset

60 mm standard backset. Refer to Ordering Procedure for extended backsets.

Door Thickness

32 to 45 mm. Locksets to suit thicker doors are available on application.

Security Rating

Standard 3670 Series Cylinder Mortice Locks conform with Level S2 (Physical Security Australian Lock Standard (AS-4145.2-1993). Conformance with Level S3 (Physical Security) is available upon request.

Durability Rating

All 3670 Series Cylinder Mortice Locks conform with level D3 (Durability) Australian Lock Standard (AS-4145.2-1993).

Furniture

Lockwood 1800 and 2800 Series Securafix Furniture.

Functions

Available in Nightlatch, Deadbolt, Vestibule Set and Combination lock configurations - refer to relevant pages within this catalogue for further function detail.

- Nightlatch Functions - pages 4-5
- Deadbolt Functions - pages 6-7
- Vestibule Set Function - pages 8-11
- Combination Lock Functions - pages 14-15



Keying

Can be keyed alike, master keyed, grand master keyed, maison keyed or construction keyed in Lockwood security keying systems.

Electric Lock

Available in an electric lock version. 60 mm standard backset.

Standard Finishes

Chrome Plate	CP
Satin Chrome	SC
Polished Brass	PB

Dimensions

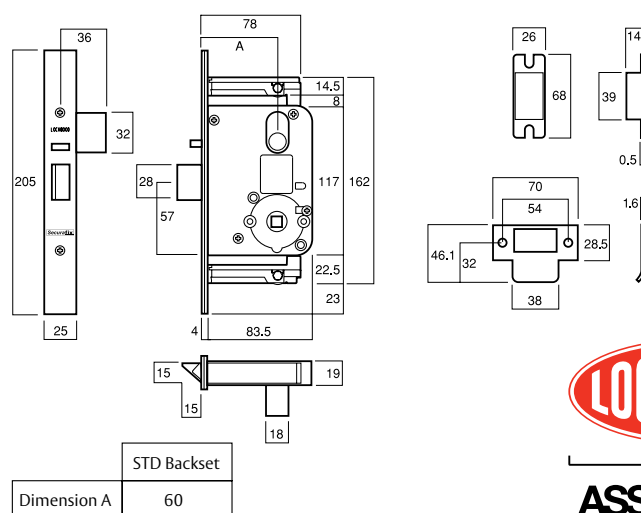

3570 Series Cylinder Mortice Locks

3570 Series Accessories

Short/Extended Lipped Strikes

Standard finishes

Chrome Plate	CP
Satin Stainless Steel	SSS
Polished Brass	PB

To order, add finish code to part number.

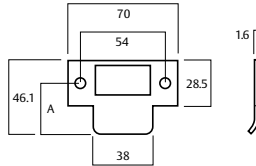

Dimension "A"

Finish	25.4mm	32mm	43.5mm	47.5mm
SSS,	SP3570-4053	SP3570-5053	SP3570-5253	SP3570-54536
CP, PB	SP3570-4153	SP3570-5153	SP3570-5353	SP3570-5653

Latching Strike

Alternative strike for use with 3573 functions to allow door to latch when bolt is projected.

Part No.

Chrome Plate	SP3573-5053CP
Satin Chrome	SP3573-5053SC
Polished Brass	SP3573-5053PB

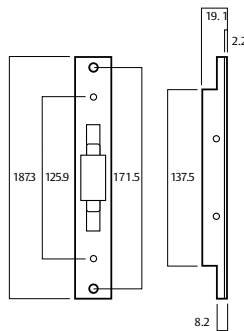

Rebate Kits

Rebate kits to suit standard 13mm rebate.

Latch Rebate Kits (3570, 3572, 3574, 3577, 3578)

Standard finishes

Chrome Plate	CP
Satin Chrome	SC
Polished Brass	PB

To order, add finish code to part number.

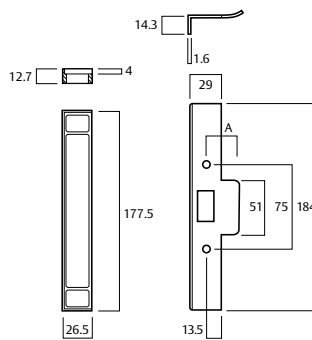

Lip Length "A"	Rebate Kit Part Number
32mm	3570-2902
46mm	3570-3902

Deadlock Rebate Kits (3571/3573)

Rebate Kit part No. 3571 - 2902

Standard finishes

Chrome Plate	CP
Satin Chrome	SC
Polished Brass	PB

To order, add finish code to part number.

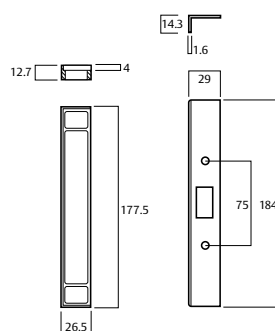

3570 Accessories

Hold Back Cylinder:

- For use with 3570 locks only;
- Special latching cylinders with levers that enable the latchbolt to be held in retracted position
- To apply Hold Back: Insert key into cylinder and retract bolt with one full turn of key. Hold bolt depressed with finger and withdraw key
- To release Hold Back: Insert key into cylinder, rotate key one full turn and withdraw key

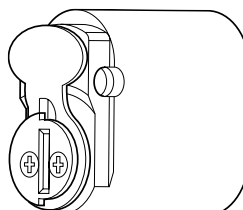

Right Hand	Part No.	Left hand	Part No.
Chrome Plate	3570-2402CP	Chrome Plate	3570-2452CP
Satin Chrome	3570-2402SC	Satin Chrome	3570-2452SC
Polished Brass	3570-2402PB	Polished Brass	3570-2452PB

Extended Cylinders:

- Extended cylinders should be considered when door thickness exceeds 50mm or when the lock is mounted off centre in the door edge.
- A range of cylinders is available to suit various door thicknesses.

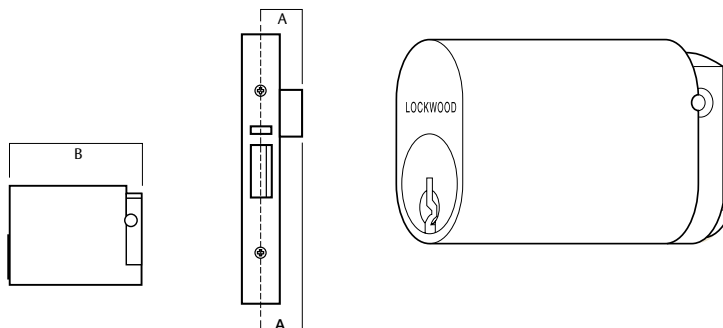

Standard Finishes

Chrome Plate	CP
Satin Chrome	SC
Polished Brass	PB

Part Number with Relevant Cam

"X" Cam	"Z" Cam	"W" Cam	"A" Cylinder Projection	"B" Cylinder Length	Door Thickness (Lock Central)
570-2/37	572-2/37	575-2/37	42	39	50 to 58
570-2/48	572-2/48	575-2/48	53	50	58 to 82
570-2/60	572-2/60	575-2/60	65	62	82 to 106
570-2/76	572-2/76	575-2/76	81	78	106 to 130
570-2/84	572-2/84	575-2/84	89	86	130 to 154
570-2/98	572-2/98	575-2/98	103	100	154 to 178



ASSA ABLOY

3570 Series Cylinder Mortice Locks

3570 Cylinder Cam & Adaptors Chart

Single Cylinder Assemblies

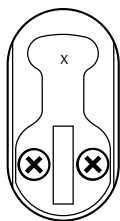

"X" CAM
570-2

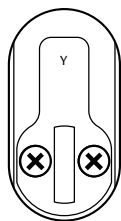

"Y" CAM
571-2

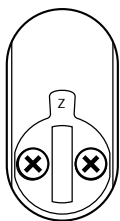

"Z" CAM
572-2

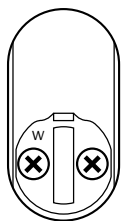

"W" CAM
575-2

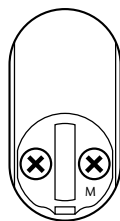

"M" CAM
575-52

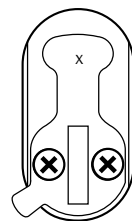

3570-6118 for
"XA" lock only
Cam included
in lock accessory

Double Cylinder Assemblies

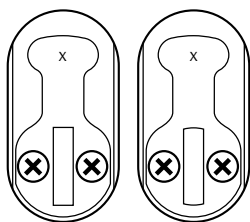

"X" CAMS
570-701

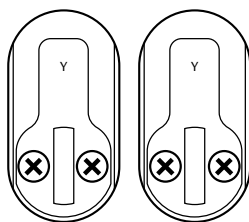

"Y" CAMS
571-701

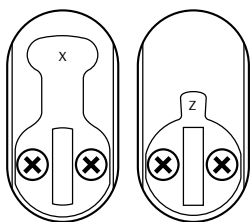

"X" CAM AND "Z" CAM
574-701

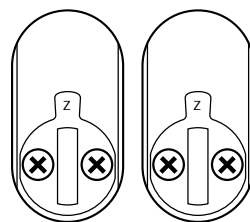

"Z" CAMS
575-701

Adaptors

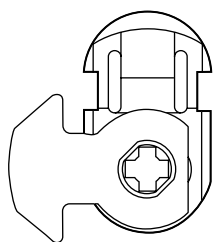

SP3570-5050

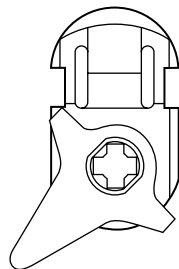

SP3571-5050

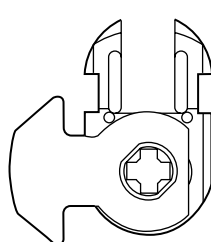

SP3570-6050

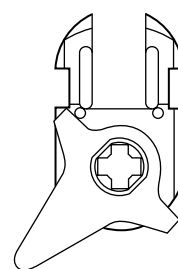

SP3571-6050

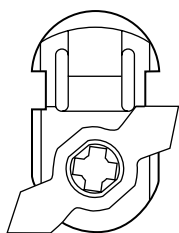

SP3572-5250

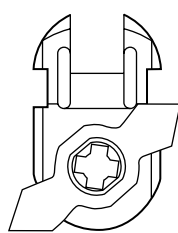

SP3572-6250

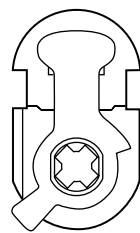

SP3572-5350
(RH)

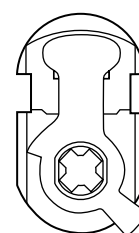

SP3572-5450
(LH)

3570 Cam/Adaptor Function Chart

	Primary Lock	Cam/Adaptor Outside	Cam/Adaptor Outside
3570	3570	-	-
3570-T	3570	-	SP3570-5050
3570X-	3570	X	-
3570XT	3570	X	SP3570-5050
3570XX	3570	X	X
3571	3571	-	-
3571DE	33571#	Y	SP3571-6150
3571-T	3571	-	SP3571-5050
3571Y-	3571	Y	-
3571WT	3571	W	SP3571-5050
3571YY	3571	Y	Y
3571PT	3571#	-	SP3571-5050
3572	3572	-	-
3572X-	3572	X	-
3572Z-	3572	Z	-
3572EA	3572*	-	SP3572-5250
3572XA	3572*	SP3570-6118	SP3572-5250
3572M-	3572	M	SP3572-5350(RH), SP3572-5450(LH)
3572WA	3572*	W	SP3572-5250
3572XT	3572	X	SP3572-5250
3572XZ	3572	X	Z
3572-Z	3572	-	Z
3572-T	3572	-	SP3572-5250
3573	3573	-	-
3573DE	3573#	Y	SP3571-6150
3573-T	3573	-	SP3571-5050
3573Y-	3573	Y	-
3573WT	3573	W	SP3571-5050
3573YY	3573	Y	Y
3573PT	3573#	-	SP3571-5050
3574WT	3573#	W	SP3572-5250
3574ZZ	3572	Z	Z
3574Z-	3572	Z	-
3574	3574	-	-
3574EA	3572*	-	SP3572-5250
3574ET	3572	-	SP3572-5250
3574ZT	3572	Z	SP3572-5050
3574XZ	3572	X	Z
3577X-	3577	X (TOP CYL) + 577-302 (BOTTOM CYL)	-
3577Z-	3577	Z (TOP CYL) + 577-302 (BOTTOM CYL)	-
3577M-	3577	M (TOP CYL) + 577-302 (BOTTOM CYL)	SP3572-5350(RH), SP3572-5450(LH)
3578	3578	-	-
3578WT	3578	W	SP3572-5250
3578Z-	3578	Z	-
3578M-	3578	M	SP3572-5350(RH), SP3572-5450(LH)

= Specially machined lockcase * = requires anti-lockout screw



ASSA ABLOY

3570 Series Cylinder Mortice Locks

Ordering Procedure

Sample Part Number 3574WTRSCAF is made up of seven elements. The description of this part number is an office locking combination latch with cylinder and turn, right handing, satin chrome, for aluminium fix. Choose your product by selecting an option from each element.

For example:

Backset	Platform	Function	Sub Function	Handing	Finish	Options	
3	57	4	WT	R	SC	AF	
Backset	Sub Functions		Handing	Finish		Options	
60mm	3	eg. Outside Inside W T	Right	R		Modric spring	M
89mm	4	Locking Cylinder with W cam	Left	L		8mm hubs	8
127mm	5	Latching Cylinder with X cam				Rounded Cover Plate	RO
Platform		Locking Cylinder with Y cam				Aluminium fix	AF
Standard (Intruder Resistant)	57	Locking Cylinder with Z cam					
SCEC Secure Area*	579	Locking Cylinder with M cam					
Securafix	67	Emergency button					
Functions		Turnbutton adaptor					
Nightlatch	0	No sub function					
Deadlock	1	Antilockout					
Vestibule lock	2						
Sliding door lock	3						
Combination lock	4						
Dual entry lock	7						
Hold back lock	8						

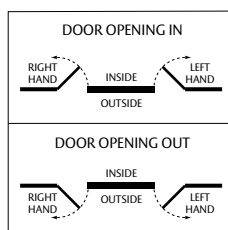

*Secure Area only available in Nightlatch, Deadlock, Vestibule and Combination configuration. Must be used in conjunction with SCEC Secure Area rated cylinder (eg Abloy Protec) and furniture (eg Lockwood 1800 series)

Code

- Backset:** Nominate backset as required, for example 3 = 60mm backset.
- Function:** Select function, for example 574 = Combination Lock.
- Sub Function:** Determine sub function requirements for both exterior and interior. For example:
Exterior – Locking function required – specify W (cylinder).
Interior – turnknob function required – specify T (turnbutton adaptor).
- Handing:** If applicable refer to door handing chart to determine left or right hand, for example R.
- Finish:** Select appropriate finish, eg SC. Other finishes available on application.
- Options:** Where additional options are needed, specify as required, for example AF = Aluminium Fix.

Specification Service

For all Architectural hardware specification assistance refer to your local ASSA ABLOY Sales Office.

A fully comprehensive, obligation free, Architectural Door Hardware specification can be prepared by Architectural Hardware Representatives.

Quality Endorsed Company

SAI Global operates a program which assesses the quality procedures and capabilities of an organisation in terms of the requirements of specific Australian and International Standards for Quality Systems. Following assessment by



SAI Global, ASSA ABLOY Australia Pty Limited, 235 Huntingdale Rd, Oakleigh VIC 3166 has been granted a certificate of registration as a quality endorsed company complying with the requirements of AS 3902/ISO 9001 – Quality Systems for Production and Installation.

Disclaimer

Whilst every effort has been made to ensure that the information contained in this catalogue is accurate at the time of publication, ASSA ABLOY recommends that you consult ASSA ABLOY or its agents prior to placing an order to ascertain current information on specific products, as ASSA ABLOY reserves the right to make changes without notice. ASSA ABLOY will not be liable for any injury, loss or damage whatsoever, arising from any errors or omissions in the information contained in the catalogue or arising from the use or application of the information contained herein. This catalogue does not constitute an offer for the sale of any particular product.

Lockwood Guarantee and Care & Maintenance

Please go to lockweb.com.au for details on Lockwood Guarantee and product care & maintenance.

ASSA ABLOY is the global leader in door opening solutions, dedicated to satisfying end-user needs for security, safety and convenience



ASSA ABLOY



Lockwood is the leading brand in the Australian locking industry. With an established reputation for high quality products, this iconic brand provides a wide range of locking solutions to residential housing, commercial building and industrial application markets. Lockwood is supported by an extensive distribution and after-sales support network. Our customers include retailers, architects, trade and industrial personnel, locksmiths and security dealers.

ASSA ABLOY

ASSA ABLOY is the global leader in door opening solutions, dedicated to satisfying end-user needs for security, safety and convenience.

ASSA ABLOY is represented in all major regions, in both mature and emerging markets, with leading positions in Australia, Europe and North America.

As the world's leading lock group, ASSA ABLOY offers a more complete product range of door opening solutions than any other company in the market.

Australia
1300 LOCK UP (1300 562 587)
lockweb.com.au

New Zealand
Telephone +64 9415 7888
assaabloy.co.nz

ASSA ABLOY Australia Pty Limited
235 Huntingdale Road,
Oakleigh Victoria, 3166
Australia

info.au@assaabloy.com
assaabloy.com.au

ASSA ABLOY New Zealand Ltd.
6 Armstrong Road
Albany, North Shore City, 0632
New Zealand

info.nz@assaabloy.com
assaabloy.co.nz

