

## 3FT ALBANY ASSEMBLY INSTRUCTIONS

Thank you for purchasing from The Oak Bed Store. As an independent family run company, customers such as yourself really make a big difference and we sincerely appreciate it.

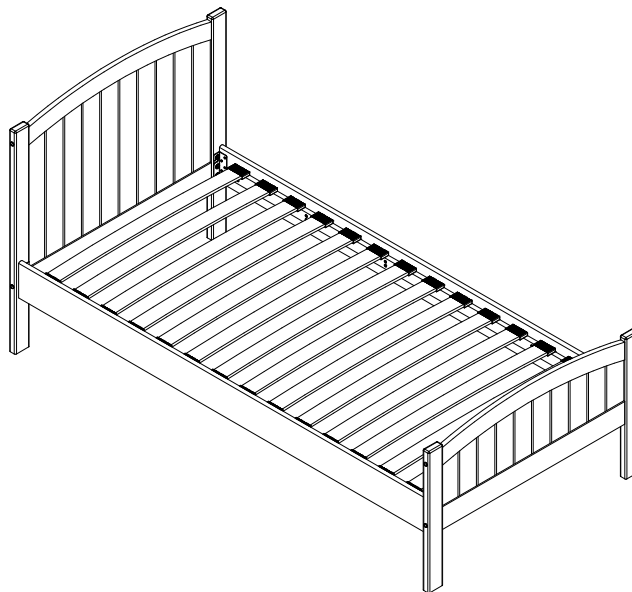

We hope you are delighted with your purchase, however if you have any further queries or concerns, please don't hesitate to contact us by;







- . Email at [help@theoakbedstore.co.uk](mailto:help@theoakbedstore.co.uk)
- . Telephone on 02392 984885
- . Live Chat via our website





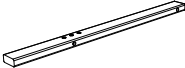

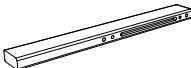
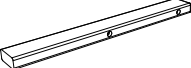
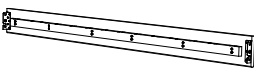
**Please read the instructions carefully before assembling or use to ensure a safe and satisfactory operation of this product.**

**Please note:**

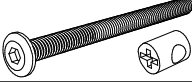
1. This product takes approximately 60 minutes to assemble with 2 people.
2. This product is heavy, it should be assembled as near as possible to the point of use.
3. Please do not drag the bed frame, always lift and reposition with 2 people to avoid personal injury as well as damage to the product.
4. Please do not discard any of the packaging until you have checked that you have all the parts and the pack of fittings.
5. DO NOT use any power tools as this may damage the frame and will invalidate any claim.
6. Periodically check all screws & fixings to ensure they are secure.
7. Please do not jump on this bed frame.
8. The fittings pack contains small parts, which should be kept away from children.

In the unlikely event that this product has missing or damaged parts, please call 02392 984885 to obtain replacements.

PART LIST				
PART	DESCRIPTION		BOX	QTY
1	Headboard Frame		1/3	1
2	HB Left Wooden Post		2/3	1
3	HB Right Wooden Post		2/3	1
4	Footboard Frame		1/3	1
5	FB Left Wooden Post		2/3	1
6	FB Right Wooden Post		2/3	1
7	Side Rail - Left & Right		3/3	2
8	Wood Slat		3/3	14

HARDWARE LIST (Found in box 3)				
PART	DESCRIPTION		BOX	QTY
A	M8 x 25mm JCBC Bolt		3/3	12
B	M6 x 90mm JCBC Bolt + Barrel Nut		3/3	8
C	M8 x 30mm Wood Dowel		3/3	8
D	Wood Button		3/3	8
E	Single End Plastic Cap		3/3	28
F	M6 Allen Key		3/3	1
G	M8 Allen Key		3/3	1

**Step 1:** Attach the headboard frame (1) to the left (2) and right (3) wooden post. Please secure using hardware B,C,F and D.

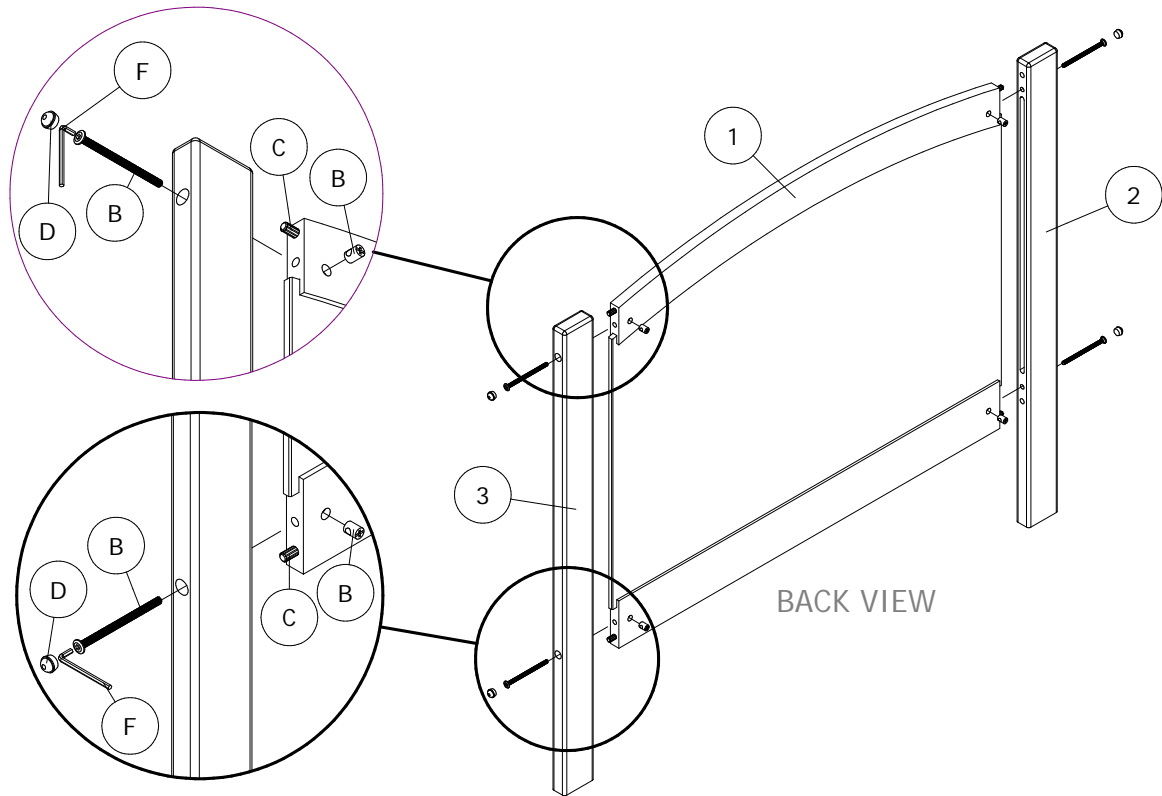

**Step 2:** Attach the footboard frame (4) to the left (5) and right (6) wooden post. Please secure using hardware B,C,F and D.

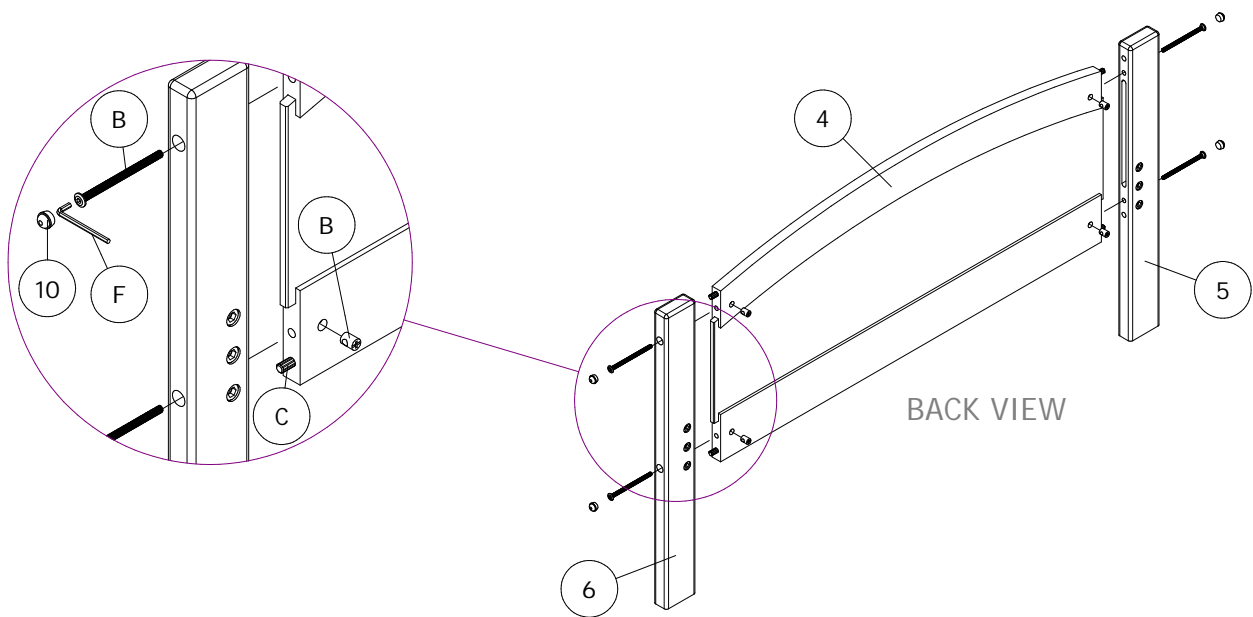

**Step 3:** Attach the side rail (7) to the headboard (1) and footboard (4) using bolt (A) and allen key (G) as shown ensuring the pre-drilled holes on the side rail are facing up.

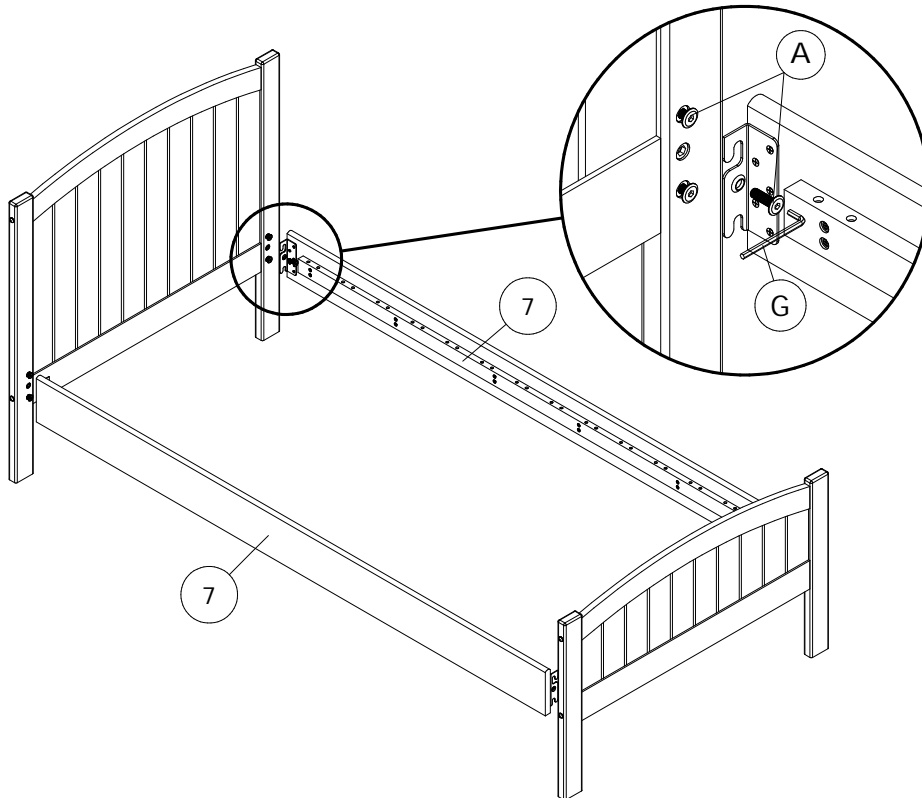

**Step 4:** Fix the Plastic Cap (E) onto the Sprung Slat (8) and insert into the pre-drilled holes on the Side Rails, please note you may need to press firmly into place.

