

Dulap

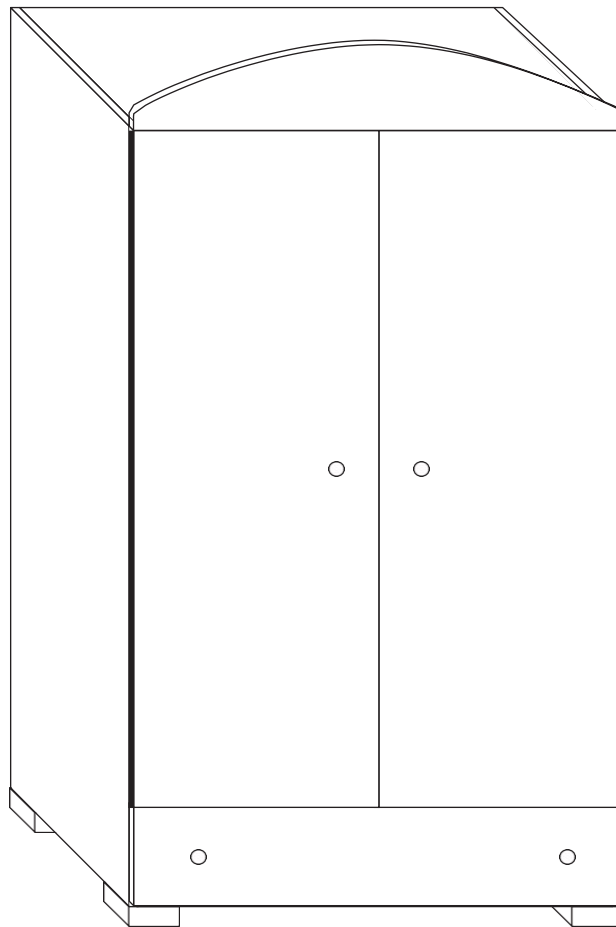

**IMPORTANT: CITIȚI CU ATENȚIE ȘI PĂSTRAȚI
PENTRU UTILIZARE ULTERIOARĂ**

***IMPORTANT: READ CAREFULLY
AND RETAIN THIS SHEET FOR FURTHER USE***

Instrucțiuni de asamblare

INSTRUCȚIUNI ȘI PRECAUȚII DE UTILIZARE

- Nu vă agățați de ușile dulapului, nu agățați obiecte grele de ele și nici nu exercitați o presiune necorespunzătoare asupra lor în special atunci când sunt deschise.
- Nu stați cu picioarele pe dulap sau pe rafturile, sertarele sau ușile sale.
- Nu încărcați rafturile cu mai mult de 25 kg fiecare și sertarele cu mai mult de 4 kg fiecare.
- Evitați repararea componentelor dulapului dacă operațiunea nu este efectuată de o persoană expertă; pentru orice eventualitate contactați direct comerciantul sau producătorul.
- Evitați ca suprafețele, în special cele orizontale, să rămână în contact cu apa sau alte lichide, chiar și pentru perioade scurte de timp.
- Nu vă apropiați cu flacără deschisă. Preferabil, nu expuneți la lumina directă a soarelui.
- Nu expuneți la surse directe de căldură (încălzitoare electrice sau încălzitoare pe gaz etc.).
- Nu suspendați dulapul pe perete.
- Verificați periodic că toată feroneria dulapului este bine strânsă.
- După scoaterea din uz, dulapul sau componentele sale nu trebuie să fie aruncate în mediul înconjurător, ci transferate în sistemele publice de eliminare.

CARE OVER USE INSTRUCTIONS

- *Do not hang yourself on wardrobe's doors, do not hang anything heavy and do not press improperly on wardrobe's doors especially when they are open.*
- *Do not stand on the wardrobe and neither on its shelves, drawer or doors.*
- *Do not fill wardrobe's shelf with more than 25 kg each and do not fill wardrobe's drawer with more than 4 kg.*
- *Do not try to fix any of wardrobe's elements up if you are not professionally skilled to do it, for any reason please contact your shop or the producer directly.*
- *Do not let especially horizontal surfaces to be wet with water or other liquids even for a short period.*
- *Do not approach the wardrobe with fire flames. If possible do not expose the wardrobe to direct sun light.*
- *Do not expose the wardrobe to heat sources (gas or electric heaters).*
- *Do not hang the wardrobe on the wall.*
- *Do a periodically control on the tightening of all wardrobe's hardware.*
- *At the end of its use do not scatter the various components of the wardrobe in the environment, but bring it to a public waste disposal.*

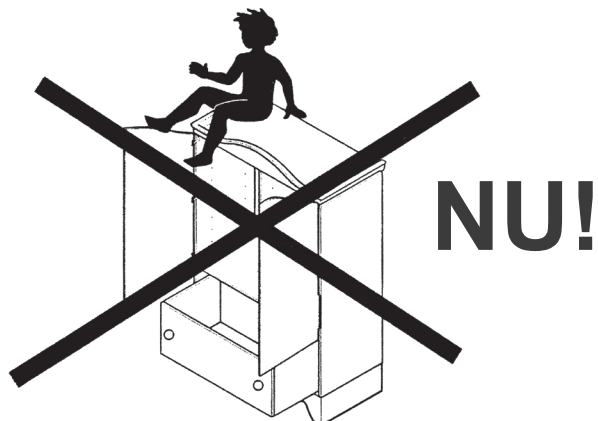

Listă componente - Parts list

Componente dulap Wardrobe parts

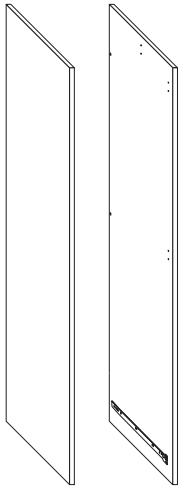

1xA1 + 1xA2

Panouri laterale stânga+dreapta
Left+right side panels

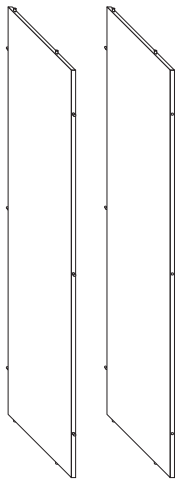

1xB1 + 1xB2

Panouri spate stânga+dreapta
Left+right back panels



1xC

Capac
Top panel

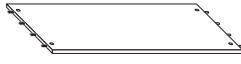

1xD

Panou central
Medium panel



1xE

Fund
Bottom panel



1xF

Șină față
Front rail



1xH

Uși
Doors



1xQ
Picioare
Feet



1xR

Șină agățat haine
Clothes hanging rail

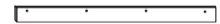

1xO

Șină față
Front rail



1xJ

Cornișă
Top frontal panel

Componente sertar Drawer parts



1xL

Panou față
Front panel



1xM

Panou spate
Back panel



1xN1

Panou stânga
Left panel



1xN2

Panou dreapta
Right panel

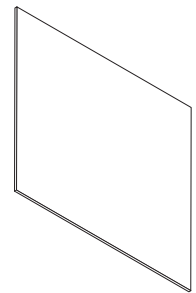

1xP

Fund
Bottom panel

Feronerie Hardware parts

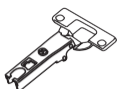

6xa



6xb



24xc
15mm



12xd

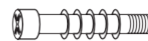

12xe
36mm

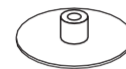

12xf



4xg



2xh



4xi
20mm



4xj



4xk



4xm



1xn
Adeziv



12xf



4xq

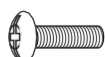

4xr
20mm



8xt
50mm



4xv
25mm



2xw
30mm

Unelte necesare Tools needed



Pasul
1

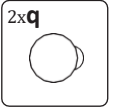
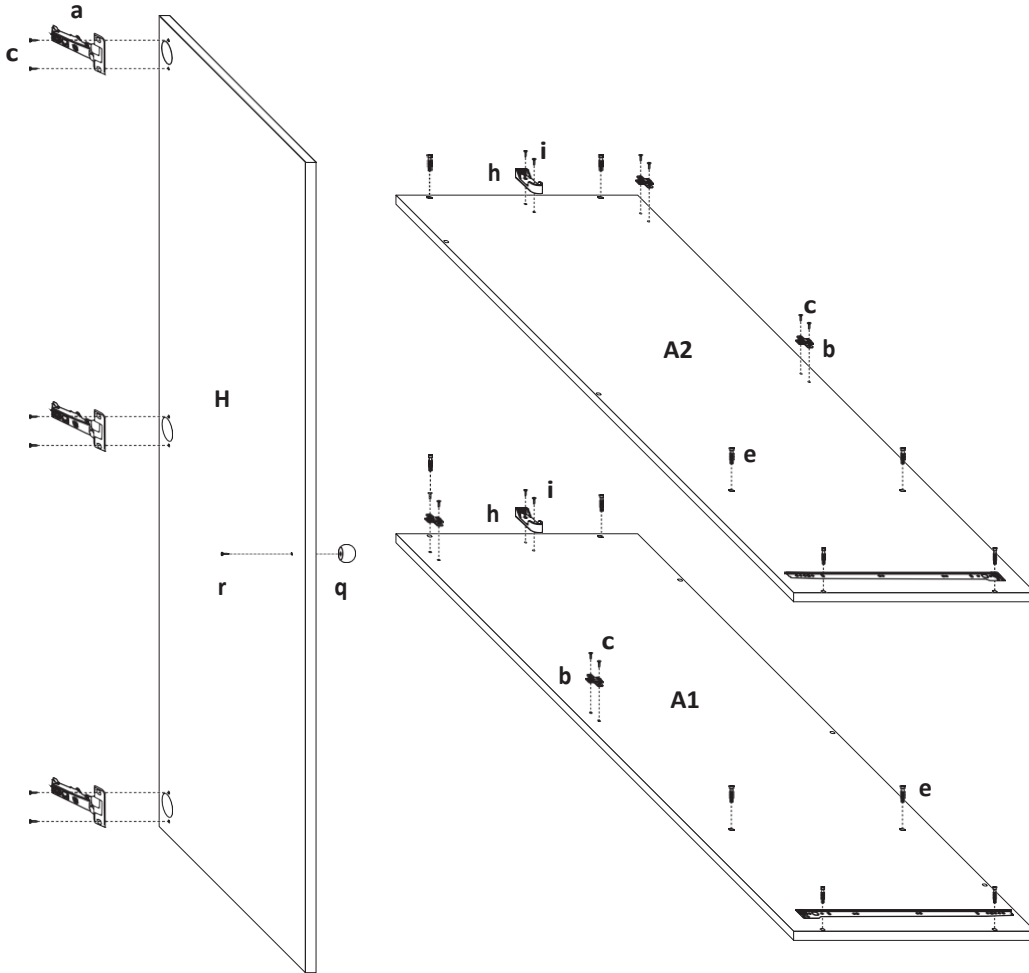

Pasul
2

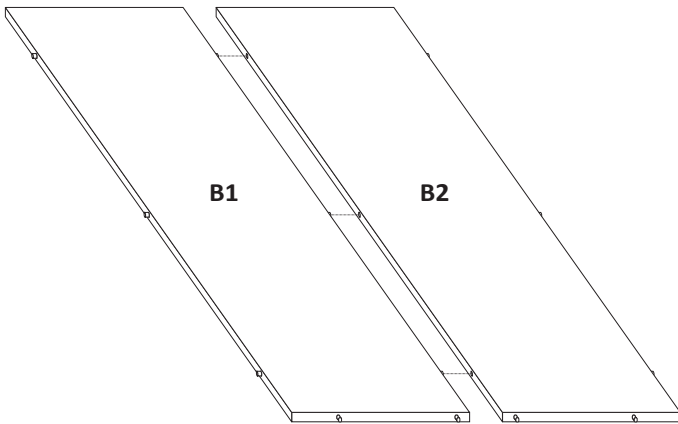

Pasul
3

Capac **c**
Top **c**

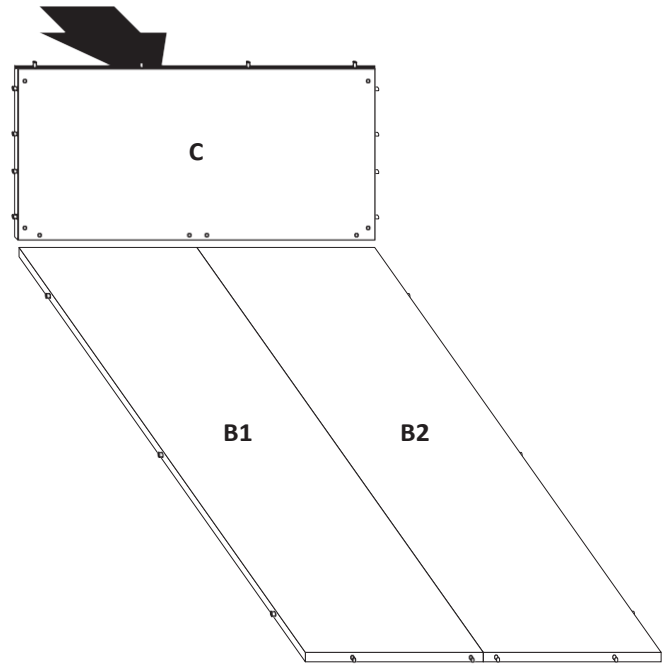

Pasul
4

8x**t**



8x**m**

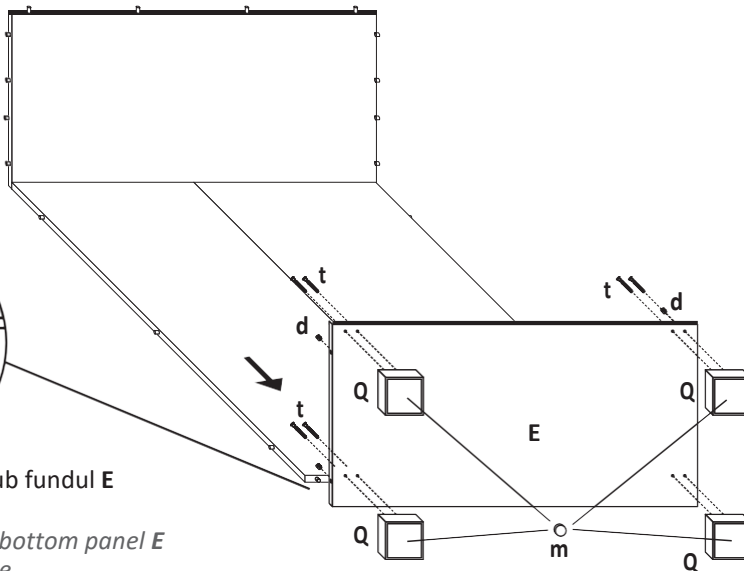
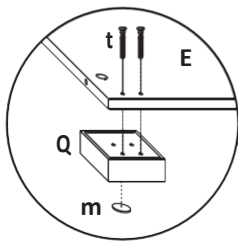

Montați cele patru picioare **Q** sub fundul **E** înainte de a asambla cadrul.
*Apply the four feet **Q** below the bottom panel **E** before the assembly of the frame.*

Pasul
5

4x

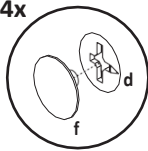

4x**d**



4x**e**



4x**f**

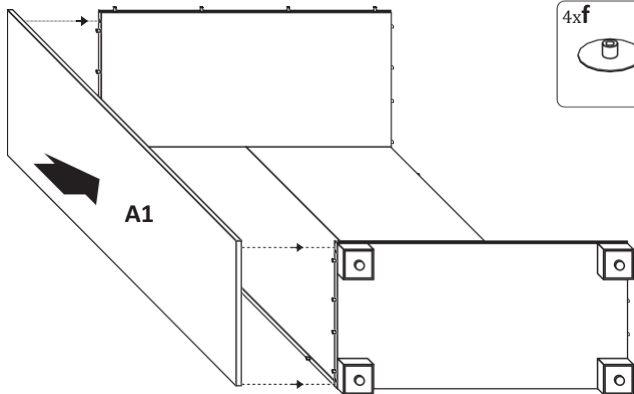

Pasul
6

8x**d**



8x**e**



8x**f**

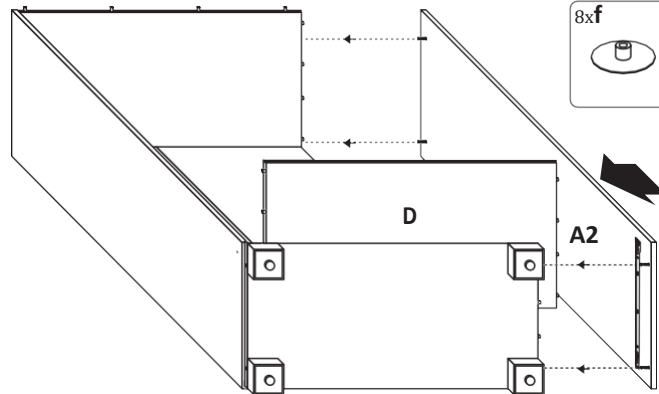

Pasul
7

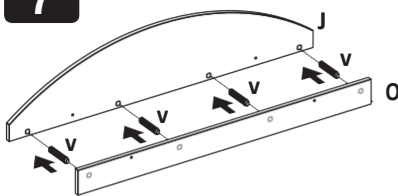

1° montați știfturile **v**

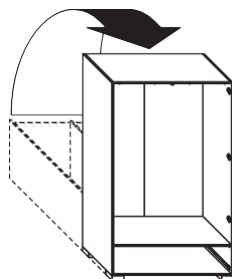

3° rabatați dulapul

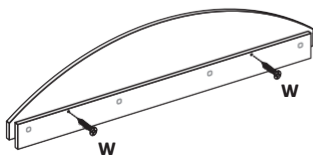

2° înșurubați șuruburile **w**

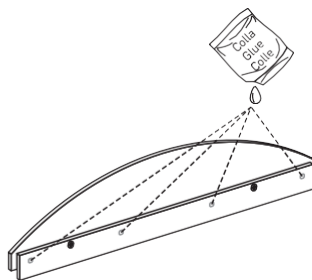

4° puneți adeziv în găuri

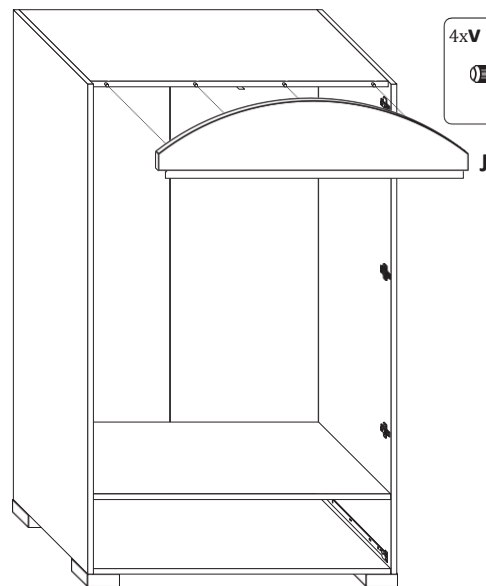

5° montați cornișa asamblată anterior

4x**v**



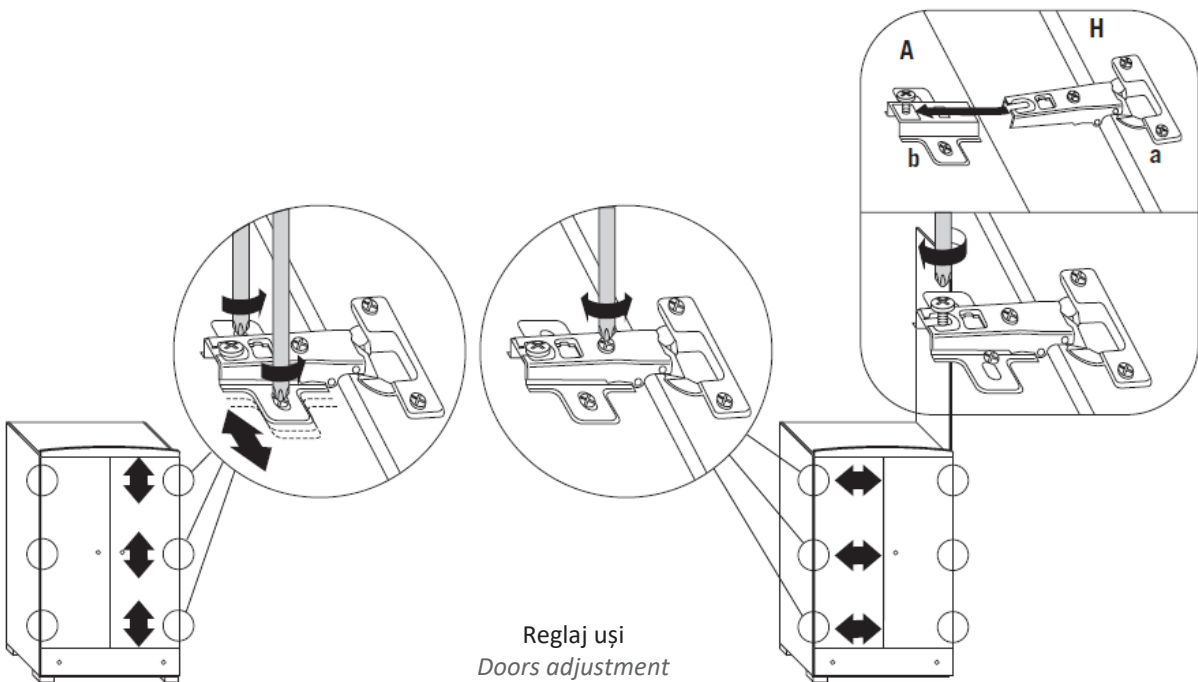
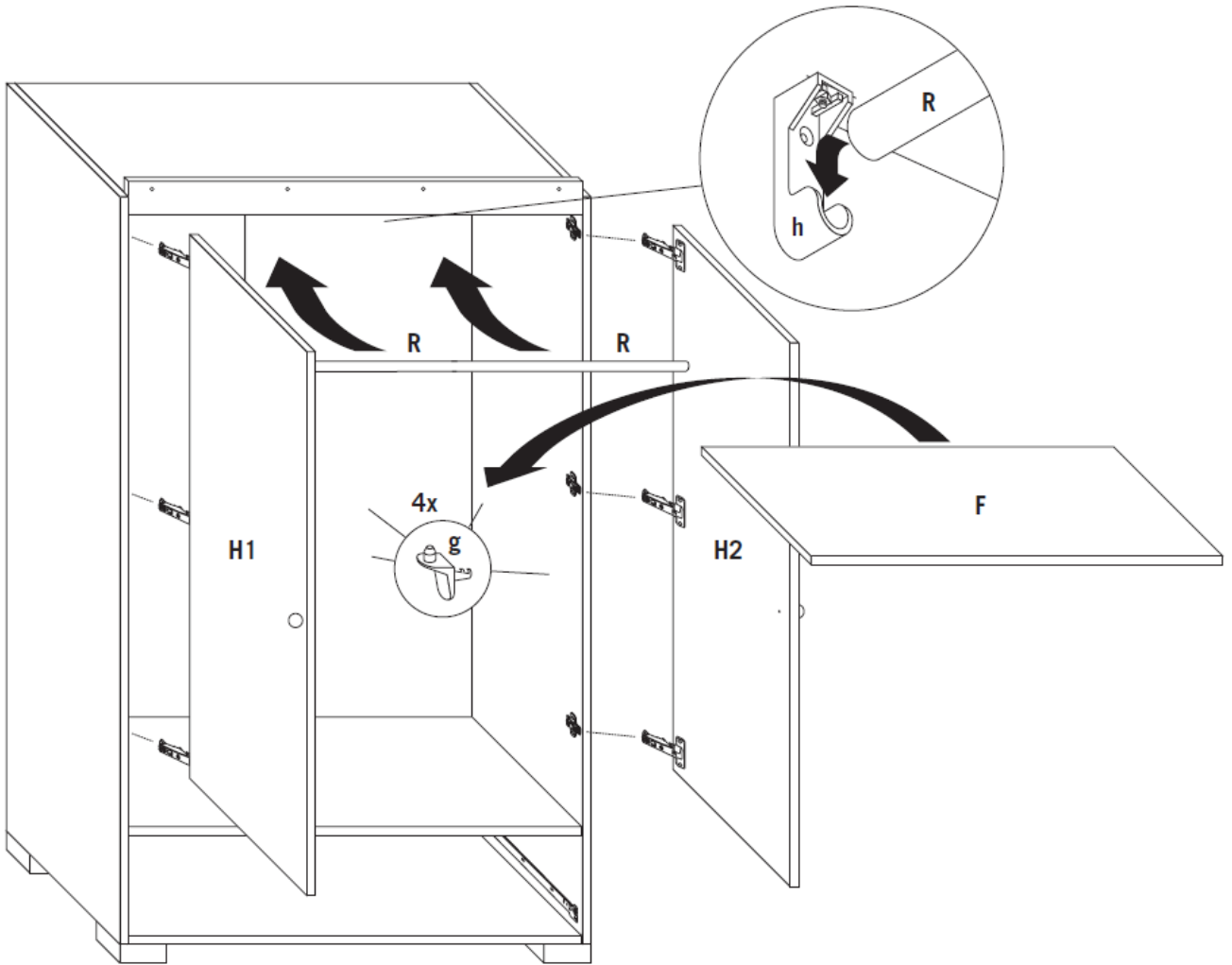

Reglaj uši
Doors adjustment

Pasul
10

Asamblare sertar
Drawer assembly

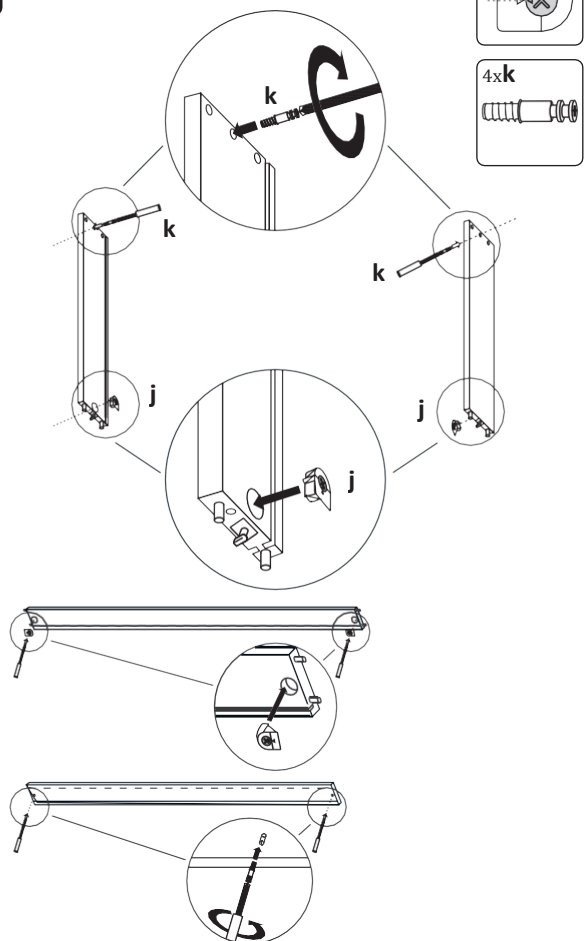

Pasul
11

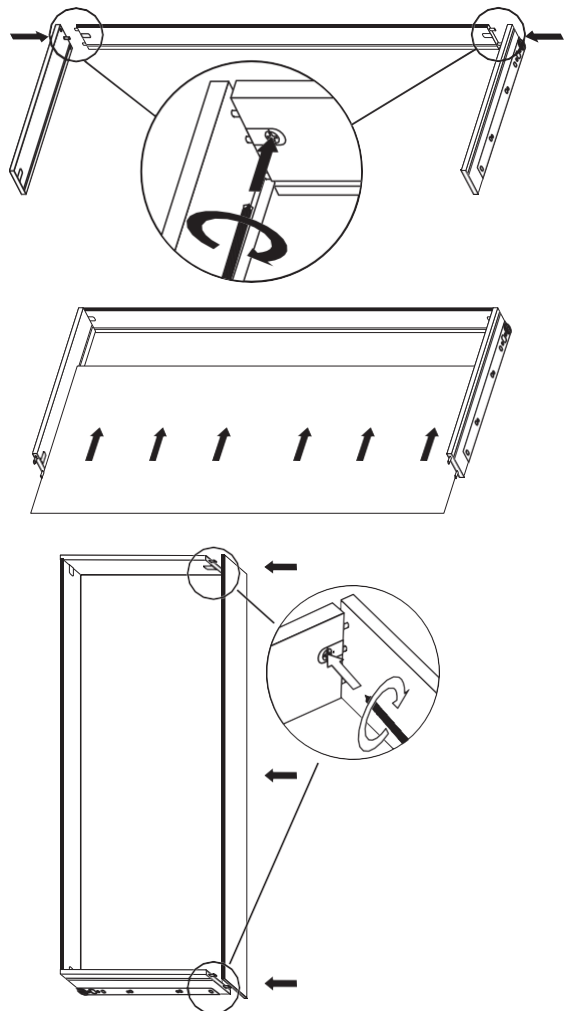

Pasul
12

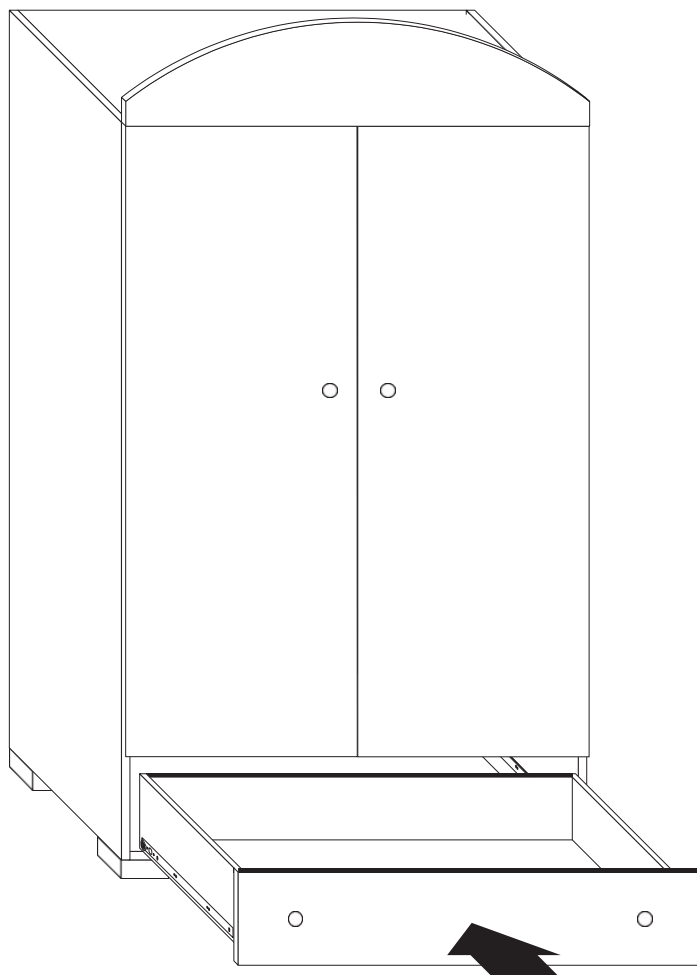

Descriere listă piese - Parts list description

Piesă <i>Part</i>	Cantitate <i>Quantity</i>	Descriere <i>Description</i>	Materiale componente <i>Parts composition</i>
A1+A2	1+1	Panouri laterale stânga + dreapta <i>Left + right side panels</i>	PAL melaminat <i>Melamminic particleboard</i>
B1+B2	1+1	Panouri spate stânga + dreapta <i>Left + right back panels</i>	PAL melaminat <i>Melamminic particleboard</i>
C	1	Capac <i>Top panel</i>	PAL melaminat <i>Melamminic particleboard</i>
D	1	Panou central <i>Medium panel</i>	PAL melaminat <i>Melamminic particleboard</i>
E	1	Fund <i>Bottom panel</i>	PAL melaminat <i>Melamminic particleboard</i>
F	1	Rafturi <i>Shelves</i>	PAL melaminat <i>Melamminic particleboard</i>
H	2	Uși <i>Doors</i>	MDF acoperit / PAL melaminat <i>Coated MDF / Melamminic particleboard</i>
J	1	Cornișă <i>Top frontal</i>	PAL melaminat <i>Melamminic particleboard</i>
L	1	Panou față sertar <i>Drawer front panel</i>	MDF acoperit / PAL melaminat <i>Coated MDF / Melamminic particleboard</i>
M	1	Panou spate sertar <i>Drawer back panel</i>	PAL acoperit <i>Coated particleboard</i>
N1+N2	1+1	Panou stânga + dreapta sertar <i>Drawer left + right panel</i>	PAL acoperit <i>Coated particleboard</i>
O	1	Șină față <i>Front rail</i>	PAL melaminat <i>Melamminic particleboard</i>
P	1	Fund sertar <i>Drawer bottom panel</i>	MDF <i>MDF</i>
Q	4	Picioare <i>Feet</i>	Plastic ABS / Fag masiv <i>ABS plastic / Solid beechwood</i>
R	1	Șină agățat haine <i>Clothes hanging rails</i>	Metal <i>Metal</i>
a	6	Balamale ușă <i>Doors hinges</i>	Metal <i>Metal</i>
b	6	Suporturi balama <i>Hinges supports</i>	Metal <i>Metal</i>
c	24	Șuruburi pentru balamale și suporturi <i>Screws for hinges and supports</i>	Metal <i>Metal</i>
d	12	Excentrici <i>Eccentrics</i>	Metal <i>Metal</i>
e	12	Tije <i>Stay bolts</i>	Metal <i>Metal</i>
f	12	Capace pentru excentrici <i>Caps for eccentrics</i>	Plastic <i>Plastic</i>
g	4	Suporturi raft <i>Shelf supports</i>	Metal <i>Metal</i>
h	2	Suporturi șină agățat <i>Hanging rail supports</i>	Plastic <i>Plastic</i>
i	4	Șuruburi pentru suporturi șină agățat <i>Screws for hanging rail supports</i>	Metal <i>Metal</i>
J	4	Excentrici pentru sertar <i>Eccentrics for drawer</i>	Plastic / Metal <i>Plastic / Metal</i>
k	4	Tije pentru sertar <i>Stay bolts for drawer</i>	Metal <i>Metal</i>
m	4	Pâslă adezivă <i>Adhesive pads</i>	Țesătură <i>Fabric</i>
n	1	Plic de adeziv <i>Glue bag</i>	Adeziv vinilic <i>Vinylic glue</i>
p	1	Cheie hexagonală <i>Allen wrench</i>	Metal <i>Metal</i>
q	4	Butoane <i>Handles</i>	Plastic ABS / Fag masiv <i>ABS plastic / Solid beechwood</i>
r	4	Șuruburi pentru butoane <i>Screws for handles</i>	Metal <i>Metal</i>
t	8	Șuruburi pentru picioare <i>Screws for feet</i>	Metal <i>Metal</i>
v	4	Dibluri din lemn pentru cornișă <i>Wood pins for top frontal</i>	Fag masiv <i>Solid beechwood</i>
w	2	Șuruburi pentru fixare cornișă <i>Screws for Top Frontal</i>	Fag masiv <i>Solid beechwood</i>