

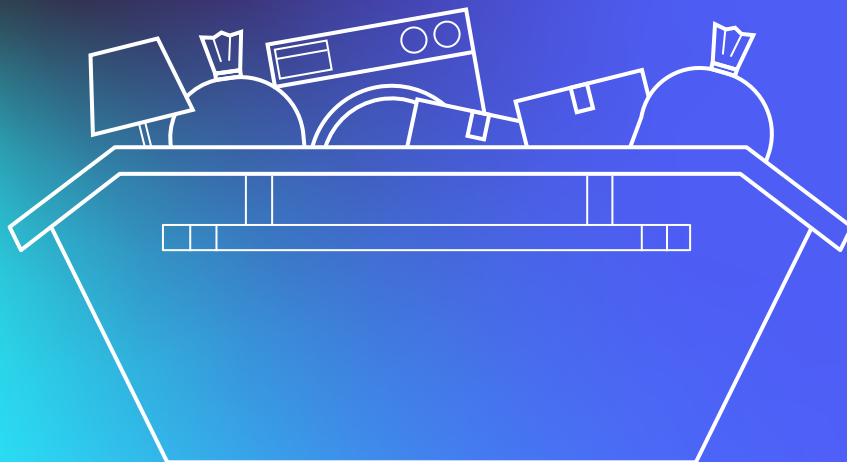

ama
skip hire

01 **The complete guide to skip hire**

You have the questions
and we have the answers.



02 The handy guide to skip hire

The world of skip hire can sometimes be a confusing one. With so many rules and regulations surrounding the industry and an endless stream of skip hire companies vying for your business, how can you know what the best options for you are?

Well, to make matters a little easier and to help you through the process of skip hire and waste management, we at AMA Skips have put together this handy guide to all things skip.

What we will cover:

- what size skip do I need?
- what can I put in my skip?
- who can hire a skip?
- what permits and licences do I need?
- how to keep your skip safe
- can other people use your skip?
- what else does AMA offer?

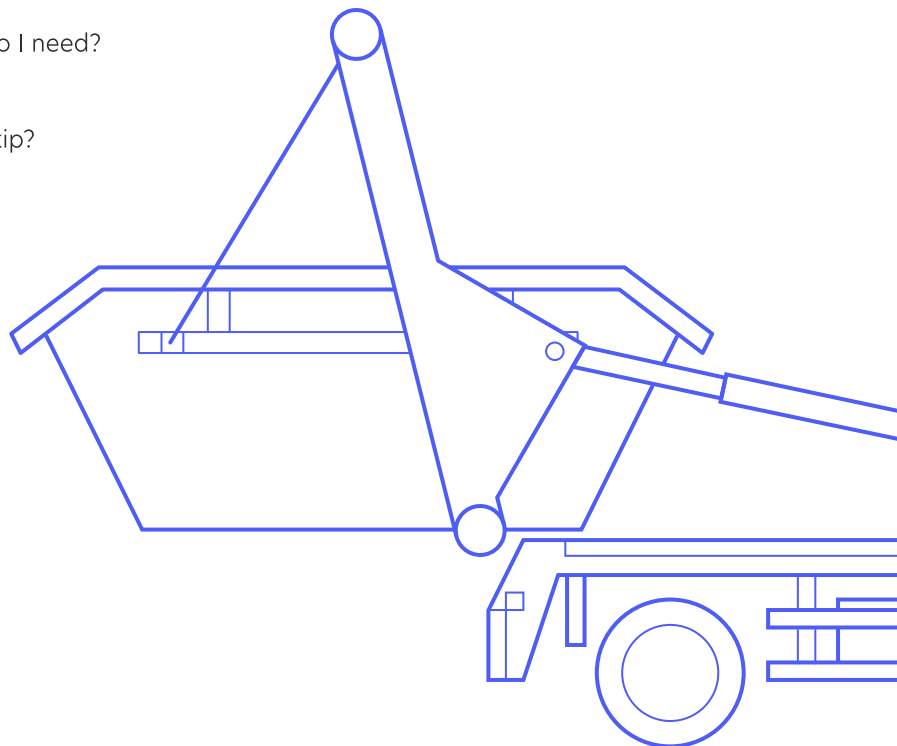

Need help?

Call us on 0330 660 0825
or visit amaskiphire.co.uk

03 What skip size do I need?

There are lots of things to consider when choosing the right size skip. Such as do I have enough room on my property for any size skip to be placed? If there is no room for the skip to be placed on private property then it will have to go on the road. This means two things firstly you will have to pay an additional permit charge (as discussed later) and secondly the biggest skip you can have is an 8 yard.

What size skip you need depends on how much waste you will have. Whilst bigger skips cost more money it is sometimes best to be safe, as one big skip is much cheaper than two smaller skips. For help in choosing the right size for you have a look at our handy graphic on the next page.

What sized skip you might need obviously depends on how much work you are doing, from a 4-yard skip for some garden work or tidying out a room in your house through to 12-yard skips for your larger projects at home or work. For a guide to what size you might want, have a look at our handy graphic on the next page.

At AMA we are able to provide skips ranging from 2 cubic yards all the way up to giant 40-yard roll-on offs skips used in the construction industry. Just get in touch with us to discuss your needs and to see what we can offer you.

Need help?

Call us on 0330 660 0825
or visit amaskiphire.co.uk

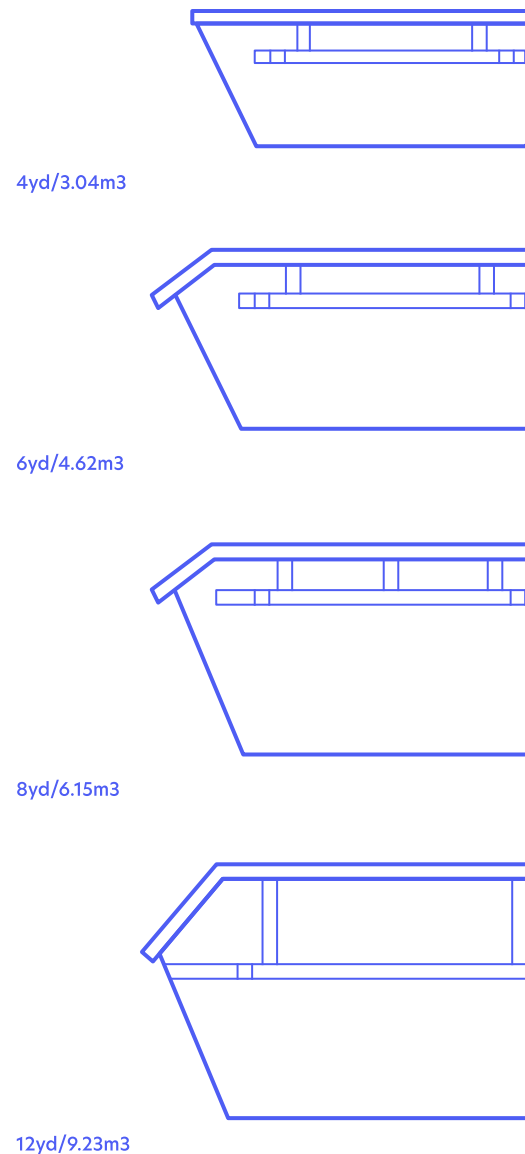

04

4yard

Ideal for a small clearout, bathroom or kitchen refit.

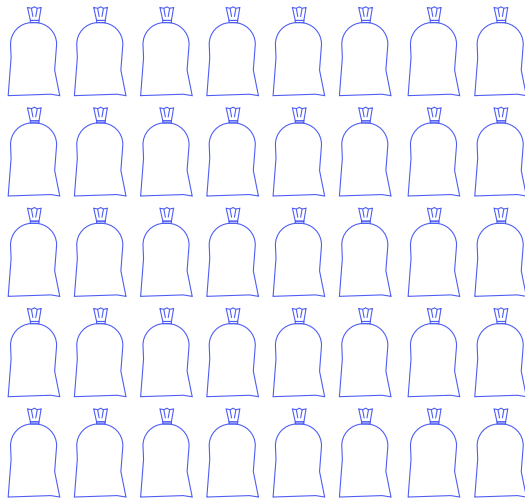

30-40 Bin Bags



6yard

Perfect for soil and rubble only.

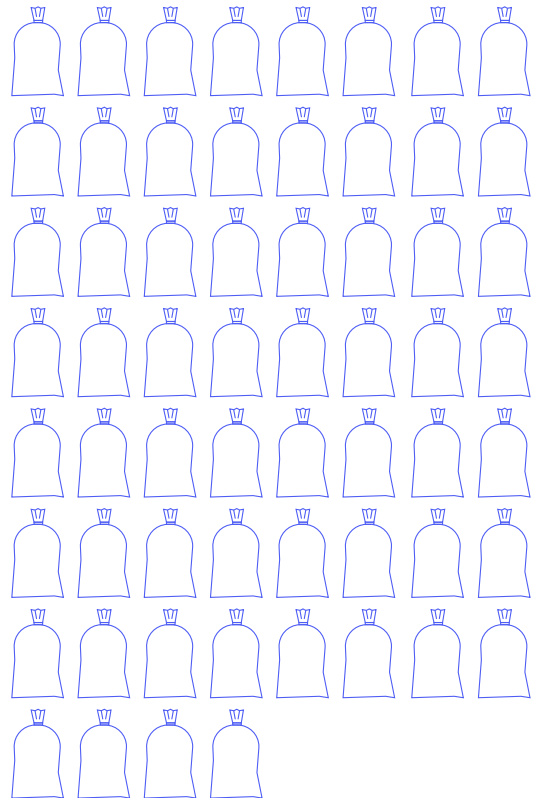

50-60 Bin Bags



Need help?

Call us on 0330 660 0825
or visit amaskiphire.co.uk

05

8yard

Our most popular skip for full house or garage clearance.

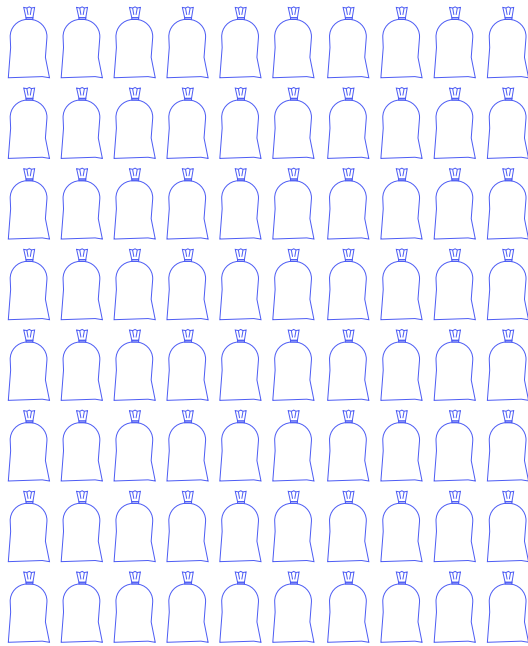

70-80 Bin Bags

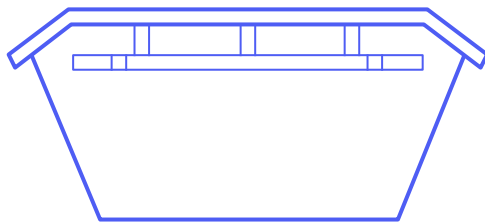

12yard

Light waste only, big house and garden clearance.

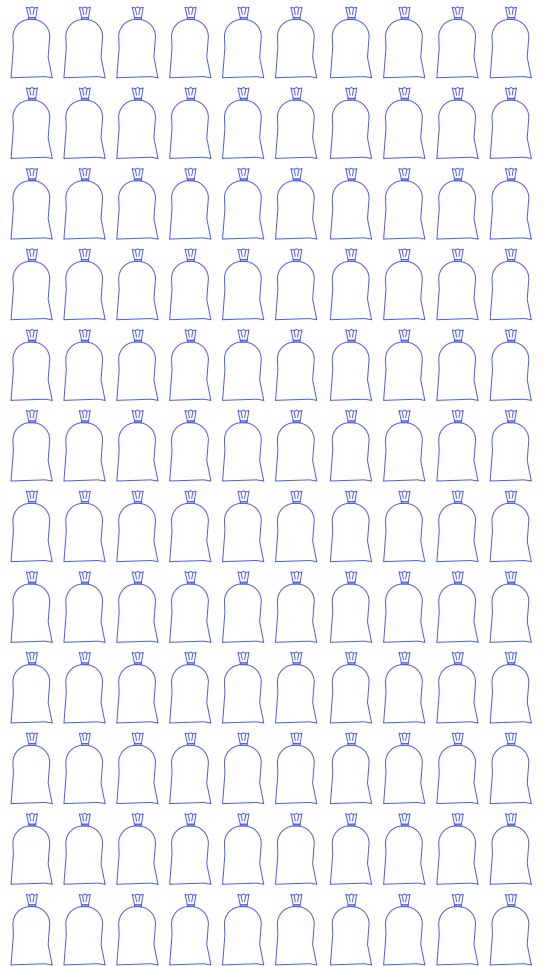

100-120 Bin Bags

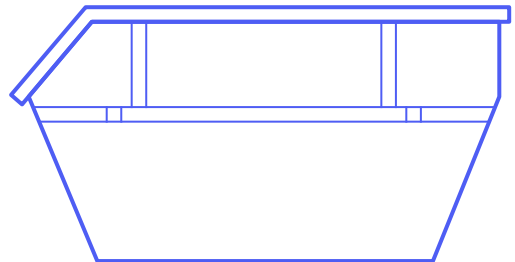

Need help?

Call us on 0330 660 0825
or visit amaskiphire.co.uk

06 What can I put in my skip?

Something which everyone needs to be aware of is what you can actually put in the skip.

Many people will assume that you can just throw anything you like into a skip, and perhaps in years gone by that was true. Due to various environmental laws implemented over the years and the practicalities of modern recycling, there are now many things that you cannot dispose of this way. A general rule of thumb is that you can't dispose of anything in a skip that might be potentially toxic and harmful, or that couldn't be recycled.

The list of items we can't accept includes:

- Fridges/freezers
- Paints/Solvents/Aerosols
- Asbestos
- Tyres
- Plasterboard
- Mattresses
- Clinical/ medical waste
- Batteries
- Florescent tubes
- TVs/Electronics/ WEEE Equipment
- Oil
- Astroturf

Most of the banned items are included on our list but, if you are ever in doubt, it's best to check with us first. Toxic waste especially could mean that your skip company refuses to take your waste and would potentially land you in trouble with local authorities.

Need help?

Call us on 0330 660 0825
or visit amaskiphire.co.uk

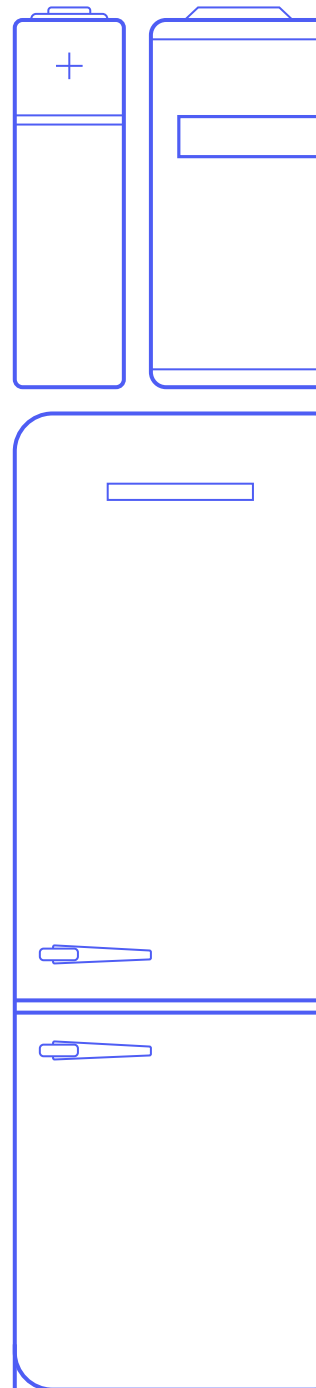

07 Who can hire a skip?

Quite simply, anyone!

From individuals looking to clear out their garden, families renovating a house, to small builders working locally to major construction firms working across the UK or even event organisers looking for large scale waste management we have a skip for you. We serve homeowners, along with commercial and industrial sectors.

Not only do we offer a skip to suit any task, but also, at AMA, we can deliver one to anywhere in the UK that you need. With over 1,000 depots nationwide, our skip delivery service covers the whole country, providing next day delivery of any sized skip, or any other service, that you need.

Whether you live in a flat in London or a manor house in the countryside, we can get a skip to you at short notice, find the perfect place to keep it and get you set up and ready for work.

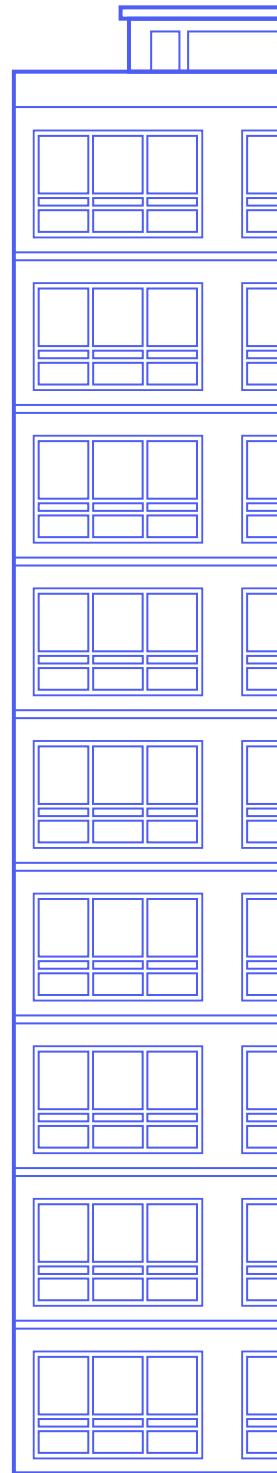

Need help?

Call us on 0330 660 0825
or visit amaskiphire.co.uk

08 What permits and licences do I need?

If you don't have a driveway, garden or private space for the skip to go on leaving a hired skip on the road may be your only option. For anyone who plans to keep a skip anywhere that isn't their land, such as public roads, pavements and pathways, permission is needed from the owner or local authority.

Most councils will allow skip hire companies to apply for permits on your behalf, making the task lots easier for you and cutting down on paperwork, though some still require private registration. If this is the case, you will need to make sure that permits are arranged before your skip arrives, and they can take a few days to process.

The majority of skip permits, whether self-arranged or not, will put some restrictions on how and where you can keep your skip. Please be aware all skips placed on a public highway need to have lights and cones. We will supply where possible and they can also be hired from many builders merchants and hire centres.

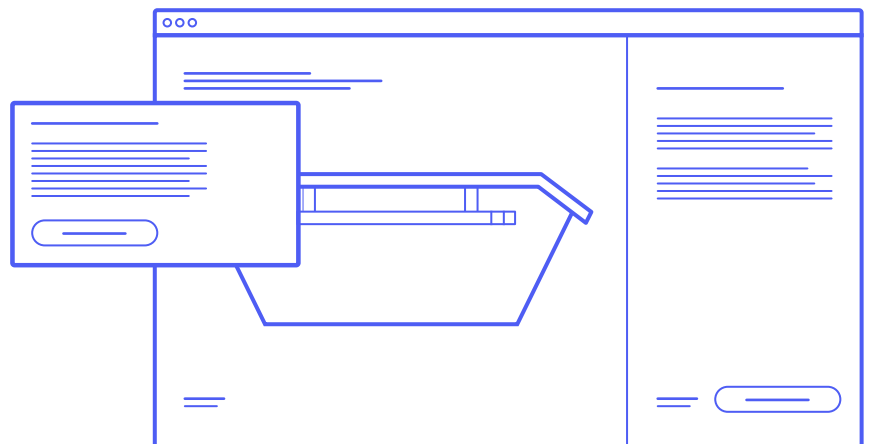

Need help?

Call us on 0330 660 0825
or visit amaskiphire.co.uk

09

Most often these rules include:

- Skips shouldn't completely block pavements and the entrance or exit to any building or property
- Utility access points, such as drains and manhole covers shouldn't be covered by a skip
- Traffic laws mean that skips can't be placed within 15m of any junction, so as not to obscure vision for motorists
- If your skip is placed across yellow lines or is in a pay-and-display bay you might need to arrange a suspension of parking laws

Even if you arrange a permit yourself, skip companies will be able to advise you on the best place to have your skip and move it for you into the safest location. Our friendly team are always on hand to advise if you need to arrange the permit yourself.

Please allow 7 days to obtain a permit. Once in place permits are only valid for 14 days.

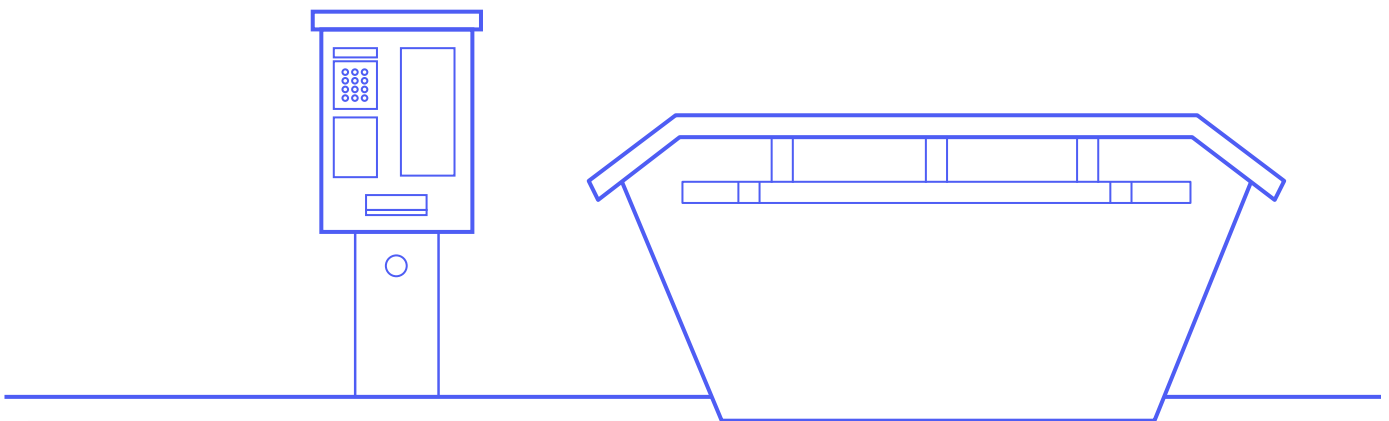

Need help?

Call us on 0330 660 0825
or visit amaskiphire.co.uk

10 How to keep your skip safe and secure

In addition to the rules imposed by having a skip licence, there are certain things that you will be required to do to make sure that your skip is kept safe and isn't a danger to motorists or passers-by.

These include:

- The contact name and phone number of the skip hire company should always be displayed clearly on the side of any skip
- Reflective markings should be used around the edges of the skip, especially if it is placed on the road
- If it is actually in the road, traffic cones should be used to guide traffic around it

Although fulfilling safety regulations should be arranged by your skip hire company, you risk a £1,000 fine if they are broken - so it's always worth checking them yourself when you receive your skip. Many local councils enforce their own restrictions too, so it is wise to consult local authorities first if you aren't sure on the rules.

Need help?

Call us on 0330 660 0825
or visit amaskiphire.co.uk

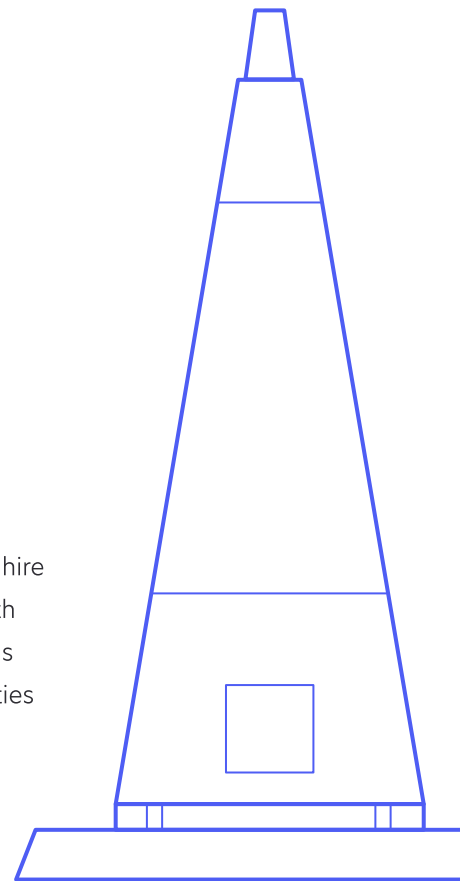

11

Can other people use your skip?

In the eyes of the law, whoever hires a skip, whether it's placed on public or private land, is responsible for all of the waste in it. If anything is thrown into your skip without your knowledge, such as hazardous waste, or if the skip becomes over full, it can pose a danger to the public, be refused collection and land you hefty fines from local authorities. Equally, if someone takes waste out of your skip and doesn't dispose of it properly, just fly tips it nearby, the fines will land on your doorstep.

There were more than 700,000 incidents of fly tipping in the UK last year, mostly consisting of domestic waste, which cost the economy and estimated £36.4million. Whilst other people can use your skip if you choose to let them, there are risks involved for you.

To prevent any potential fines, to stop people rummaging through your waste and avoid illegal rubbish ending up in your skip, using a cover is advised. Many open top skips can be fitted with covers overnight to prevent access, whilst some skip companies will offer closed skips with lockable lids to provide a more secure option.

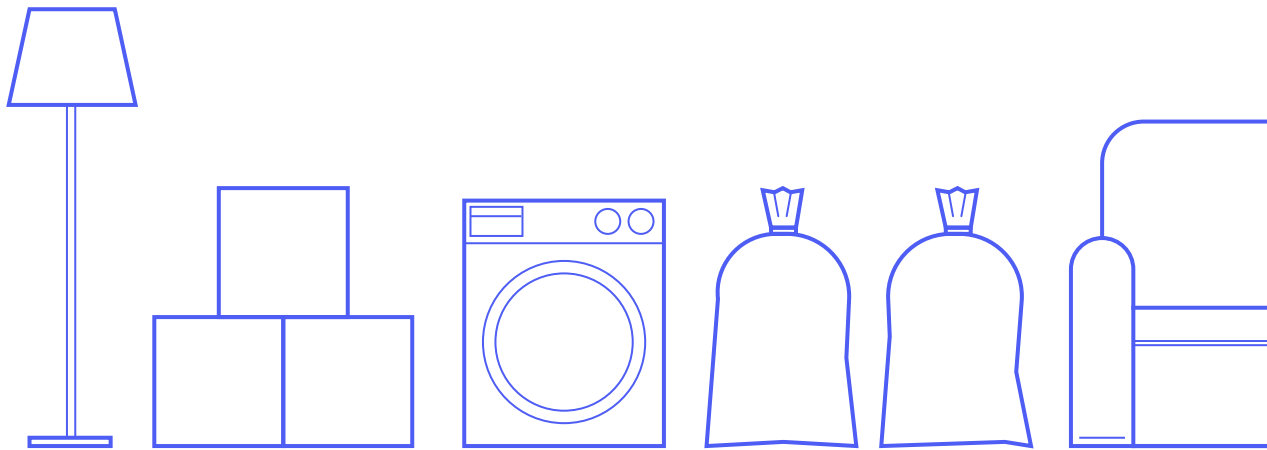

Need help?

Call us on 0330 660 0825
or visit amaskiphire.co.uk

12 What else does AMA offer?

Far from just offering skips of all shapes and sizes, here at AMA we provide a massive range of services and products for all sorts of waste management.

From portable toilets for festivals and parties to aggregates for landscaping and driveways, storage containers for on-site equipment through to hazardous waste disposal; AMA can solve all of your waste problems. We even provide containers for use as mobile office space and can provide our man-in-a-van service - clearing a site for you so that you can get on with the real hard work.

By getting in touch with us over the phone and explaining your needs, we can create a full package of waste management services to help keep your job or event running smoothly; making sure that all your needs are catered for and all the laws and regulations are followed.

Need help?

Call us on 0330 660 0825
or visit amaskiphire.co.uk



ama
skip hire

13 **Thank you.**

If you have any questions
our friendly staff will be
happy to answer them.

Call us on 0330 660 0825
Or visit amaskiphire.co.uk