

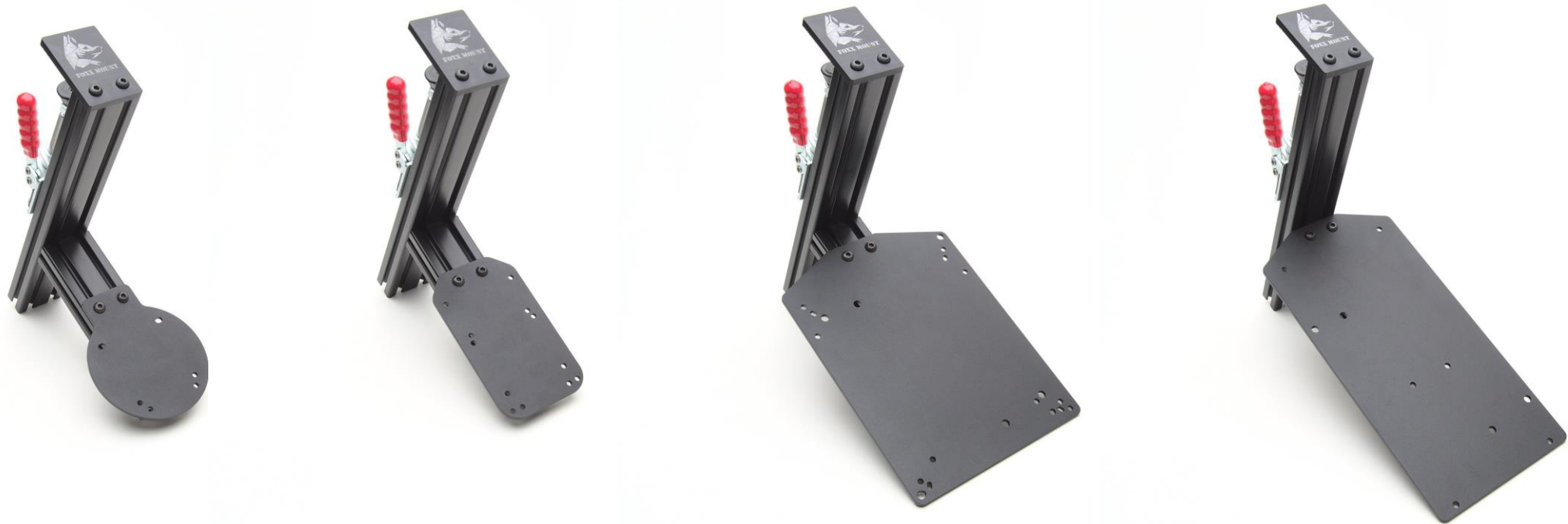

ASSEMBLING YOUR DESK MOUNT



Updated February 2021

What's in the Box

#	Description
A	Vertical Assembly: one per mounted device
B	Horizontal Beam: one per mounted device
C	Throttle Plate: plates: C, D, or E
D	Stick Plate: plates A, B, C, or D
E	Mounting Hardware: one per mounted device. Includes: <ul style="list-style-type: none"> • 2x Anchor Fasteners • 1x End Cap with Push Pins • 2x 1/4-20 Slide Nuts • 2x 1/4-20 Plate Mounting Screws • Fasteners for mounting device to the plate
F	5/32" Ball End Allen Wrench: one in every mount order

Note, this guide shows an example setup with a Virpil WarBRD Stick and MT50CM2 Throttle. The Assembly process is the same or very similar for all other mount types. Scroll to the end of the guide for images showing which holes to use for a particular device on a particular plate

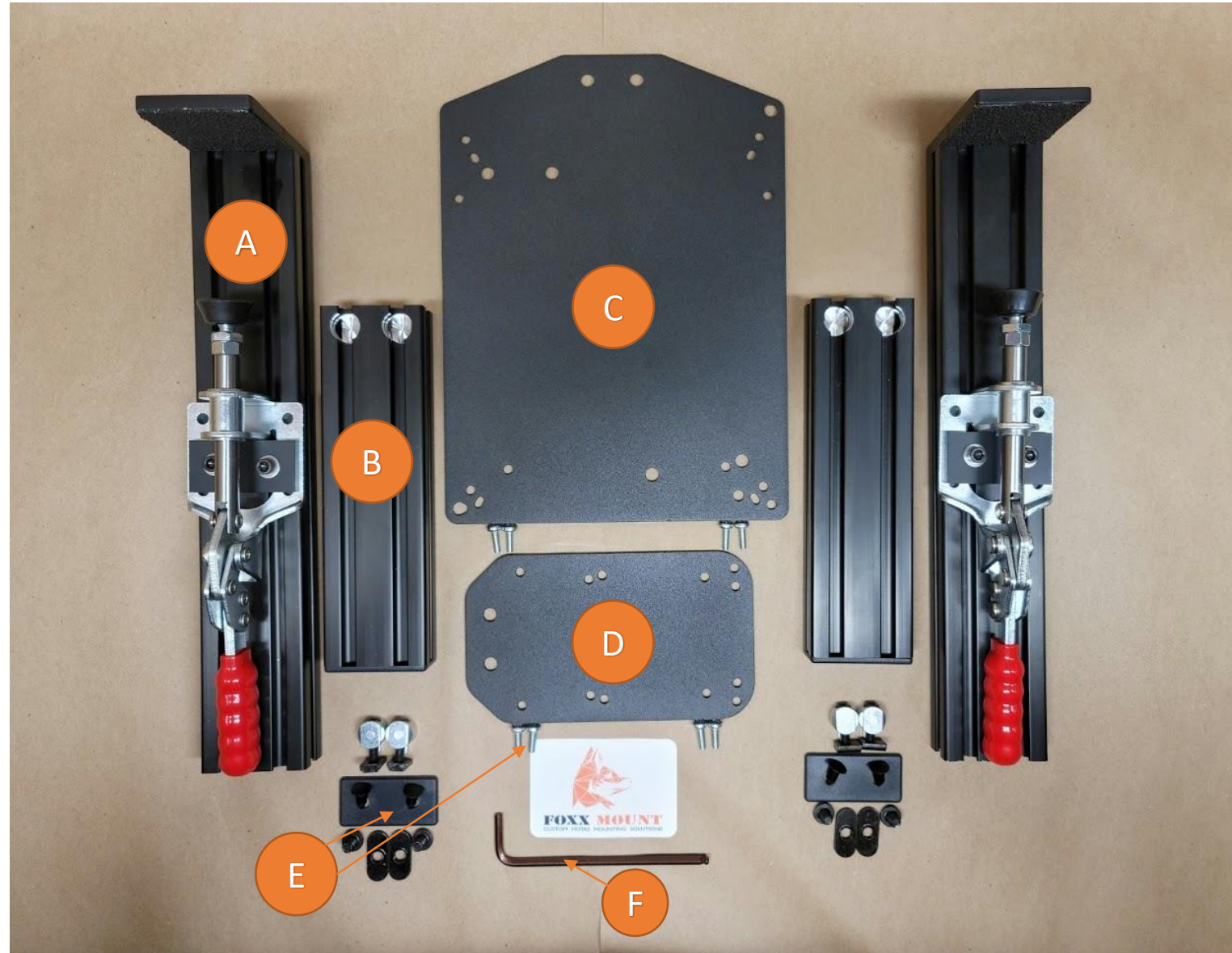

The Vertical Assembly:

Rotate the Toggle Clamp Lever to toggle between the unlocked and locked positions



For small adjustments in clamping distance, rotate the leveling foot, and secure with the locking nut

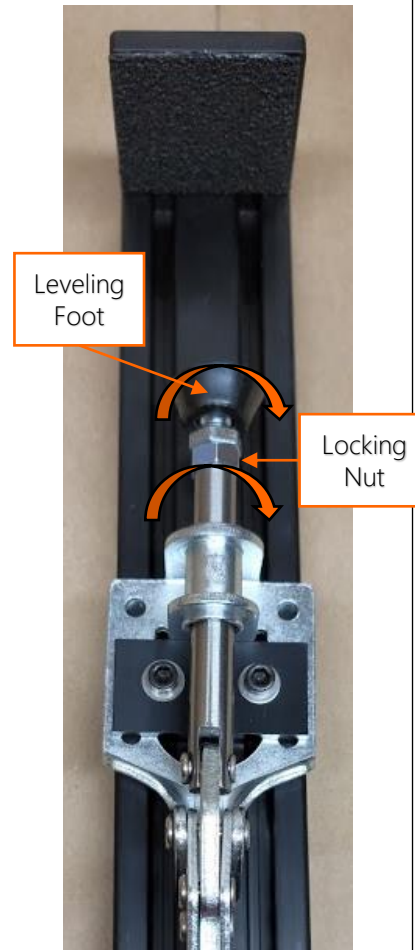

For larger adjustments, use the included Hex Key to loosen the two screws holding the Toggle Clamp, and shift up and down as needed. It should only take a turn or so to loosen. Tighten firmly when done.

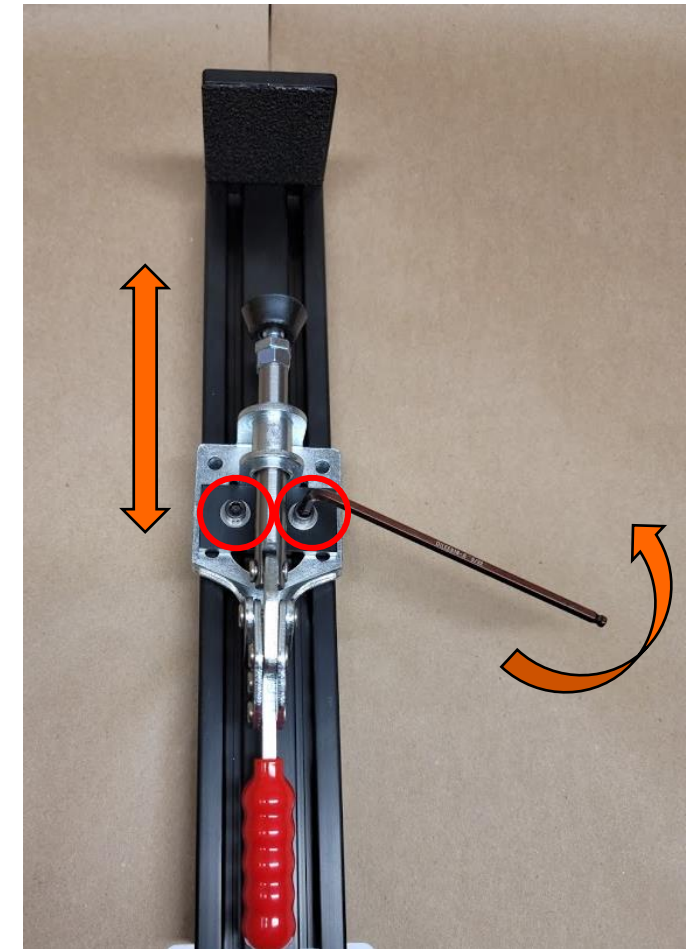

The Vertical Assembly:

Test fit the Vertical Assembly on your desk. Adjust the clamp as necessary to make a firm and secure hold. A tip for this is to screw the leveling foot fully into the shaft, flip the clamp in the upward position, loosen the two screws securing the clamp, then slide it up to touch your desk. Next, tighten the two screws holding the clamp fully tight. Then unscrew the leveling foot a few turns so that it makes a firm hold on your desk. You may need to toggle the clamp a to unscrew, then latch again. Repeat this process for both vertical assemblies.

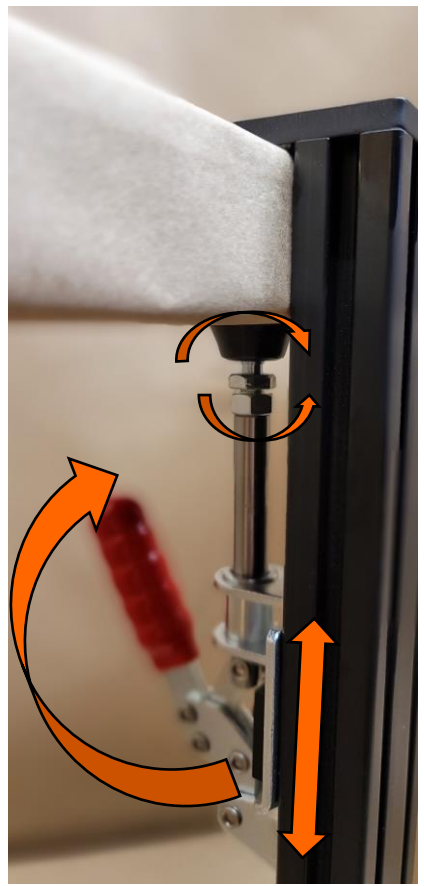

CAUTION

THIS CLAMP CAN EXERT HUNDREDS OF POUNDS OF FORCE. BE CAREFUL NOT TO OVERTIGHTEN THE CLAMP OR YOU MIGHT CAUSE DAMAGE TO YOUR DESK.

KEEP FINGERS, LIMBS, AND ELECTRICAL CORDS AWAY FROM THE LEVELING FOOT WHEN TOGGING THE CLAMP.

The Horizontal Assembly- Stick

* Horizontal beams are available in any length, 7" and 10" are standard

Each mount has a Horizontal Assembly. The assembly consists of the appropriate stick or throttle plate, a 7"* horizontal beam, 2x(1/4-20 x 3/8" bolts), 2x(1/4-20 slide nuts), as well as 2 anchor assemblies used to connect the Horizontal and Vertical Assembly

To attach the stick-plate to the horizontal beam: put the 1/4-20 x 3/8" bolts through the two topmost holes and screw the slide nuts on loosely. Slide the nuts into the channels opposite the counterbores, flip the assembly over and tighten the bolts to lock the plate at your desired location.

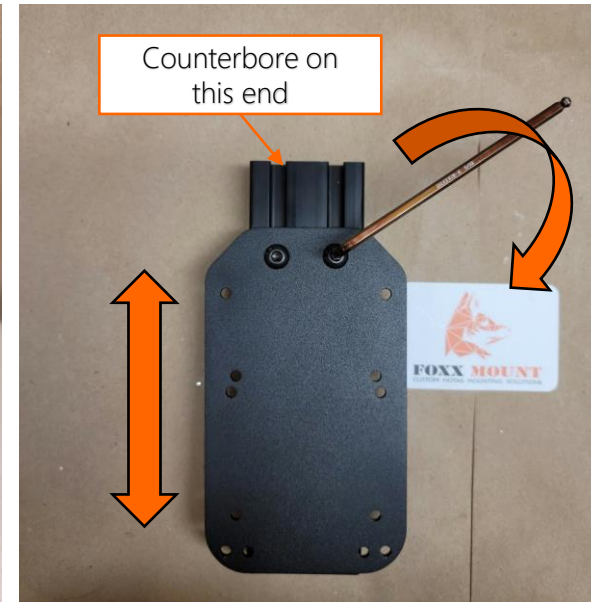

The Horizontal Assembly- Throttle

* Horizontal beams are available in any length, 7" and 10" are standard

Each mount has a Horizontal Assembly. The assembly consists of the appropriate stick or throttle plate, a 7"* horizontal beam, 2x(1/4-20 x 3/8" bolts), 2x(1/4-20 slide nuts), as well as 2 anchor assemblies used to connect the Horizontal and Vertical Assembly

To attach the throttle-plate to the horizontal beam, repeat the process for the stick-plate: put the 1/4-20 x 3/8" bolts through the two top-most holes and screw the slide nuts on loosely. Slide the nuts into the channels opposite the counterbores, flip the assembly over and tighten the bolts to lock the plate at your desired location.



Mounting the Horizontal Assembly to the Vertical Assembly

Mount the vertical assembly to your desk, then hold the stick assembly at the height you desire. Remember this location or mark it with a piece of tape. Being exact isn't important, it's just to get you in the ballpark for future adjustment. Once you have the height in mind, set the stick assembly aside, and mount the vertical assembly upside down on your desk.



Take an Anchor Assembly and loosen the nut on it such that only a few threads are engaged. Then slide it into the left slot as shown.

Repeat for the right Slot.



Mounting the Horizontal Assembly to the Vertical Assembly

Position the Stick Horizontal Assembly below the two anchors, then slide it upwards, and guide the anchors into the pockets in the rail as shown. Raise to approximately the desired height

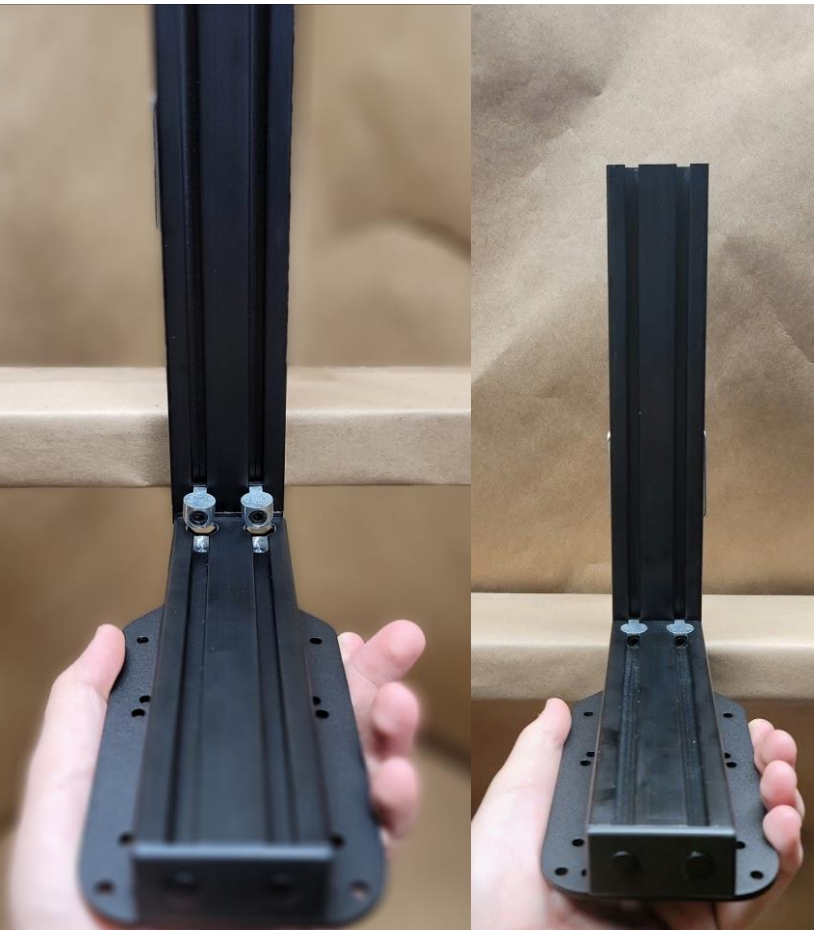

Use the Ball End of the included 5/32" Hex Key to snug up the two anchor bolts. Then use the short end for more leverage to snug them down extra tight. Take care to ensure that the horizontal beam is rotated level when tightening.

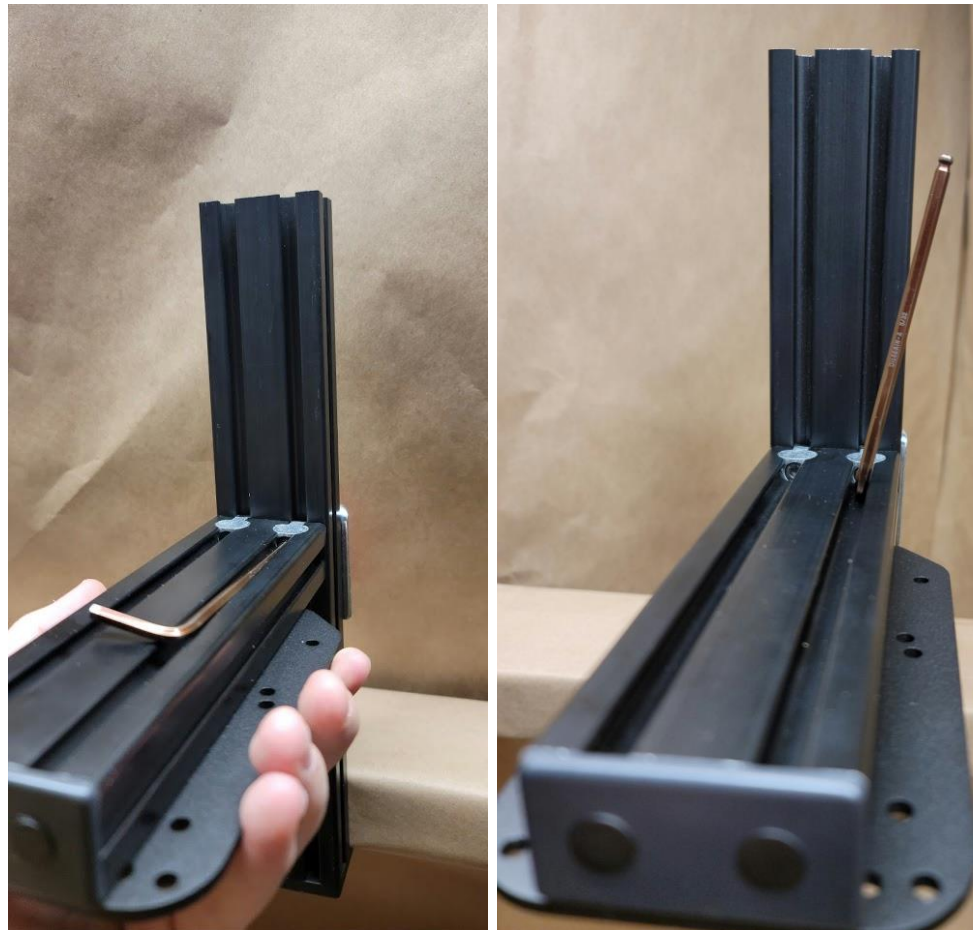

Afterwards you can install the push in fasteners.

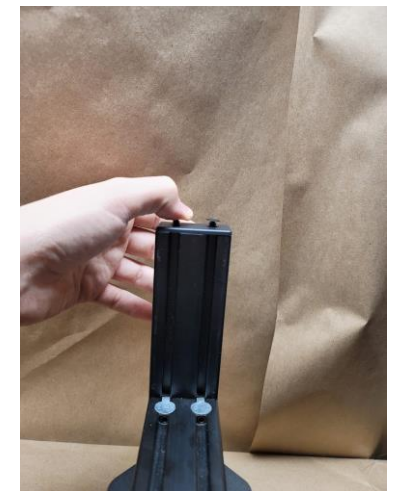

Mounting the Stick to the Assembly

Use the included mounting hardware to attach the stick to the plate, you may need a Phillip's head screwdriver depending on your stick. Once done, rotate the mount right side up and give it a feel. Adjust the height, and horizontal position as needed for optimal comfort.

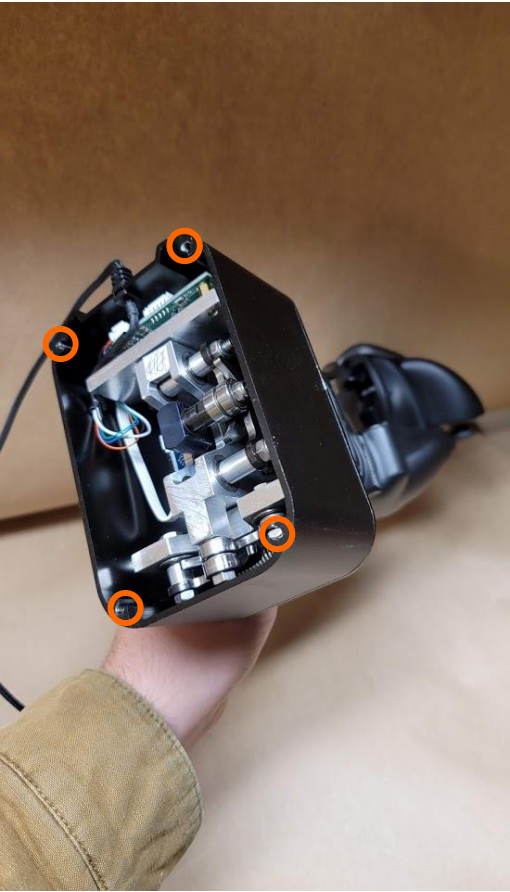

Mounting the Throttle to the Assembly

Mount the Throttle assembly to the Vertical assembly in the same way as the Stick assembly

Use the included mounting hardware to attach the throttle to the plate, you may need a Phillip's head screwdriver depending on your throttle. Once done, rotate the mount right side up and give it a feel. Adjust the height, and horizontal position as needed for optimal comfort.

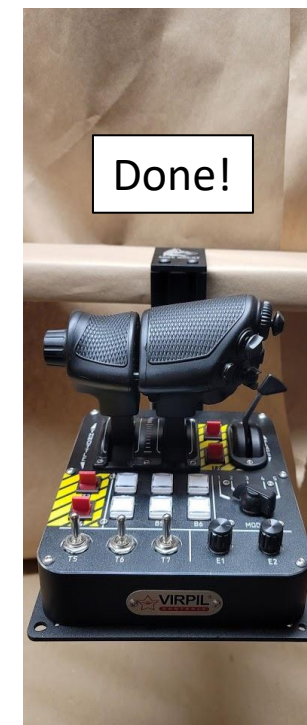

Which holes to use to mount the device to
the plate?

See the following Slides

Supported Devices	Fastener Kit
Realsimulator FSSB R3	Common M4
Thrustmaster Warthog Stick ⁽¹⁾	Common M4
VKB Gunfighter	Common M4

Fastener Kit: Common M4

- A** 1/4-20 x 3/8" Button Head Cap Screw (Qty 2)
- B** 1/4-20 Economy Slide Nut (Qty 2)
- C** M4-0.7 x 12mm Button Head Phillips Screw (Qty 4)

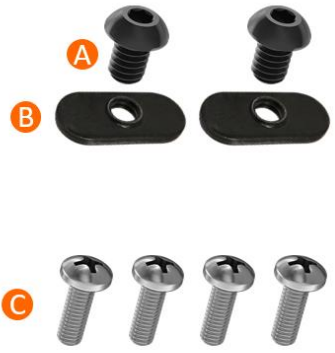

Common Plate A

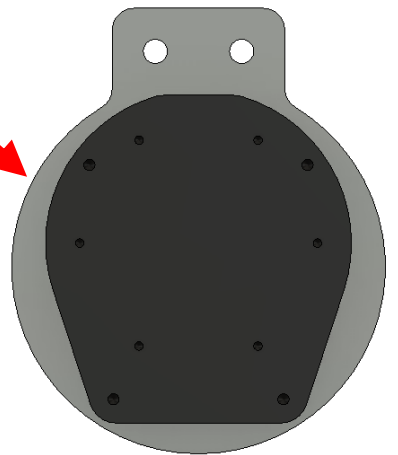
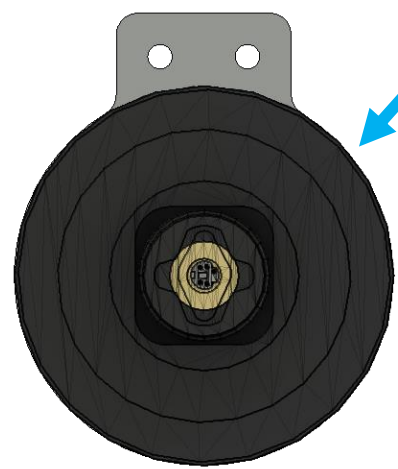
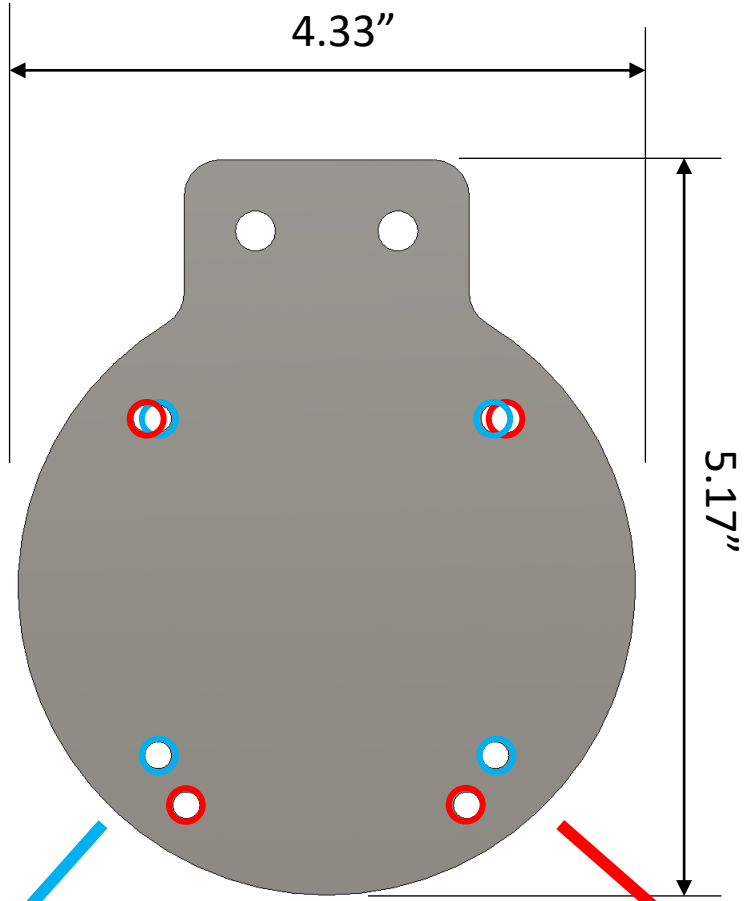

- Remove the bottom plate from the Thrustmaster Warthog Stick.
- Align the stick base with the mounting plate on your desk mount, and insert screws [A] into the holes using a Philips head screwdriver. Tighten securely.
- The same procedure is used for the FSSB R3

Plate A

Thrustmaster Warthog Stick [Plate A] or FSSB R3 [Plate A]

Fastener Kit: Common M4

- A** 1/4-20 x 3/8" Button Head Cap Screw (Qty 2)
- B** 1/4-20 Economy Slide Nut (Qty 2)
- C** M4-0.7 x 12mm Button Head Phillips Screw (Qty 4)

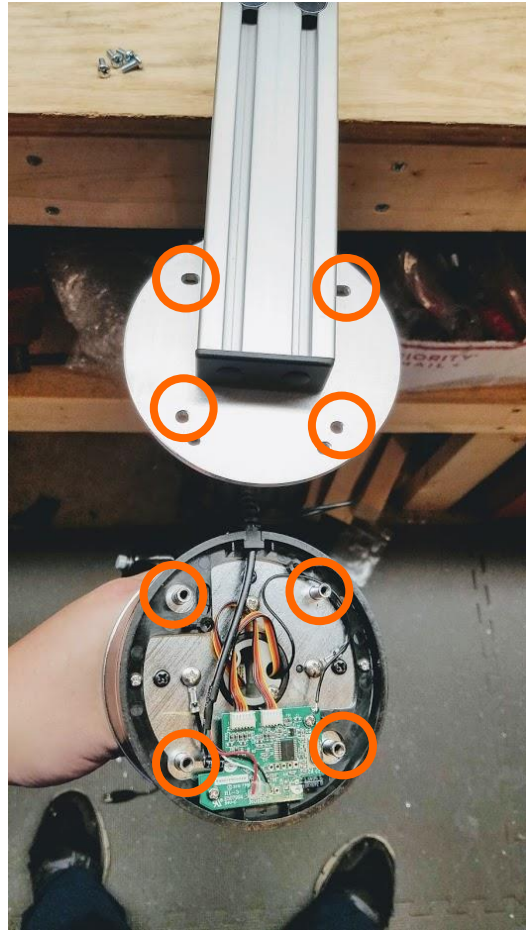

Supported Devices	Fastener Kit
Realsimulator FSSB R3	Common M4
Thrustmaster Warthog Stick ⁽¹⁾	Common M4
VKB Gunfighter	Common M4
Virpil Stick (T50/T50CM2/WarBRD)	Common M4

1) Warthog Base will overhang the sides slightly

Fastener Kit: Common M4

- A** 1/4-20 x 3/8" Button Head Cap Screw (Qty 2)
- B** 1/4-20 Economy Slide Nut (Qty 2)
- C** M4-0.7 x 12mm Button Head Phillips Screw (Qty 4)



Common Plate B

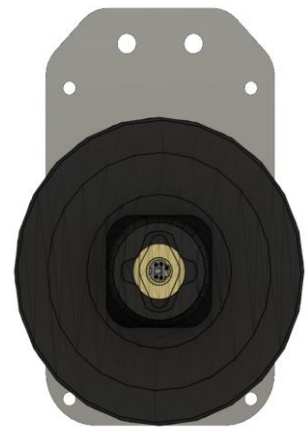
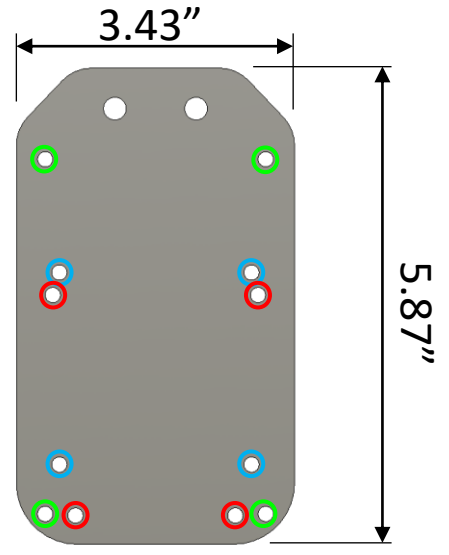

Warthog Base
or FSSB R3

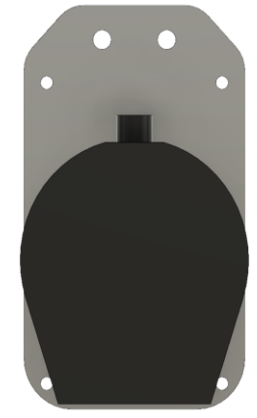

Gunfighter Base



WARBRD/T50/T50CM2 Base

Common Plate C

Supported Devices	Fastener Kit
CH Stick or Throttle ⁽²⁾	Velcro Strips
Logitech X52/X52 Pro Stick or Throttle	Logitech X52
Logitech X55/X56 Stick or Throttle	Logitech X55/X56
Thrustmaster Cougar Stick ⁽¹⁾	Common M4
Thrustmaster Cougar Throttle	Cougar Throttle
Thrustmaster T.Flight Hotas X Stick or Throttle ⁽²⁾	Velcro Strips
Thrustmaster T16000M	T16000M
Thrustmaster TWCS	T16000M
Virpil MT50CM2/CM3 Throttle ⁽¹⁾	Common M4
VKB Gladiator	Common #10

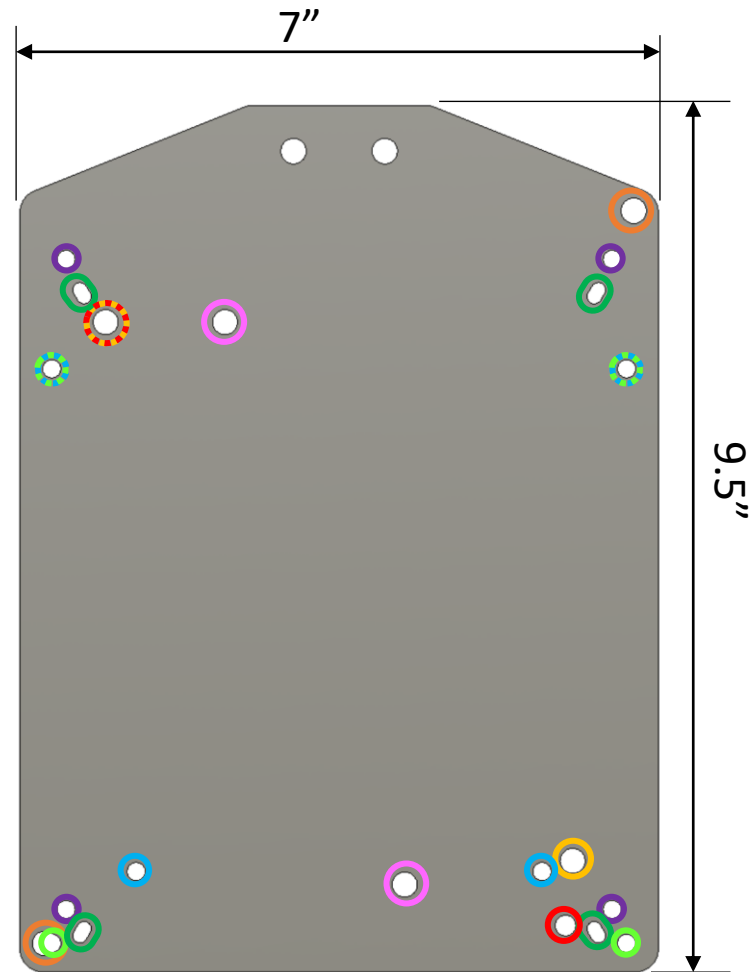

- 1) Remove bottom cover and secure to the mount plate using the threaded holes that held the cover. You will only use the 4 corners.
- 2) Attaches using provided Velcro Strips on request

Plate C
Logitech X52/X52 Pro Stick or Throttle



Fastener Kit: Logitech X52

- A** 1/4-20 x 3/8" Button Head Cap Screw (Qty 2)
- B** 1/4-20 Economy Slide Nut (Qty 2)
- C** #6-32 x 2.5" Button Head Phillips Screw (Qty 4)
- D** #6 Washer (Qty 2)
- E** #6 Nut (Qty 2)

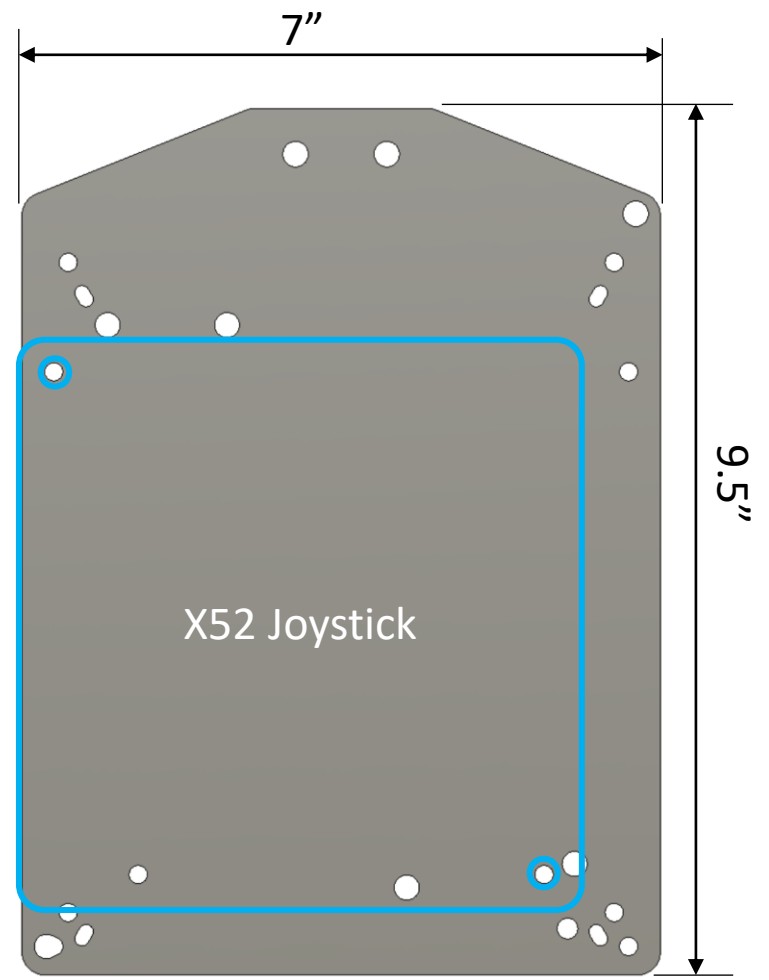
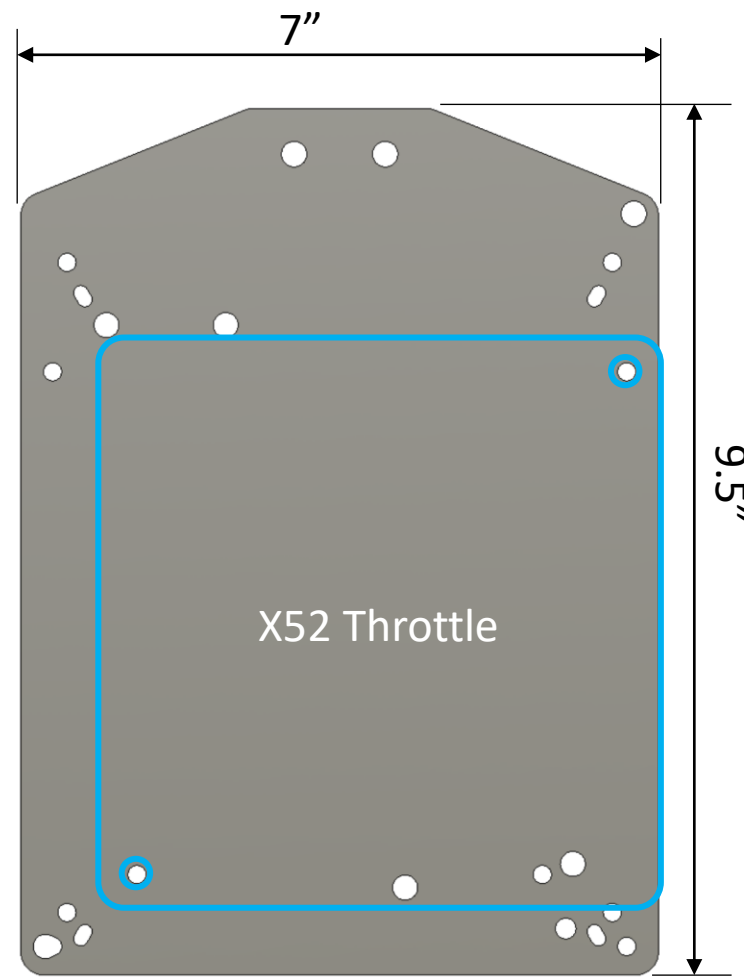
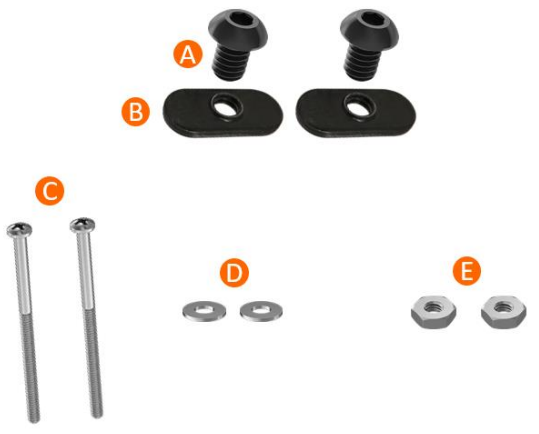

Plate C
Logitech X55/56 Stick or Throttle



Fastener Kit: Logitech X55/56

- A** 1/4-20 x 3/8" Button Head Cap Screw (Qty 2)
- B** 1/4-20 Economy Slide Nut (Qty 2)
- C** 1/4-20 x 2.5" Button Head Phillips Screw (Qty 4)
- D** 1/4-20 Washer (Qty 2)
- E** 1/4-20 Nut (Qty 2)

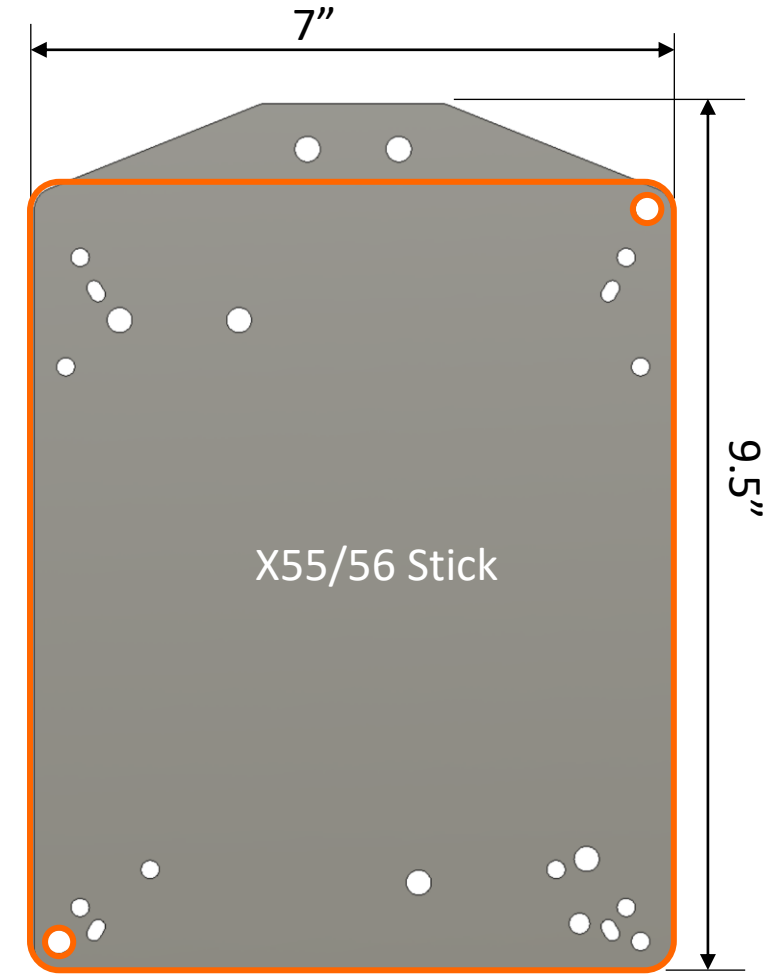
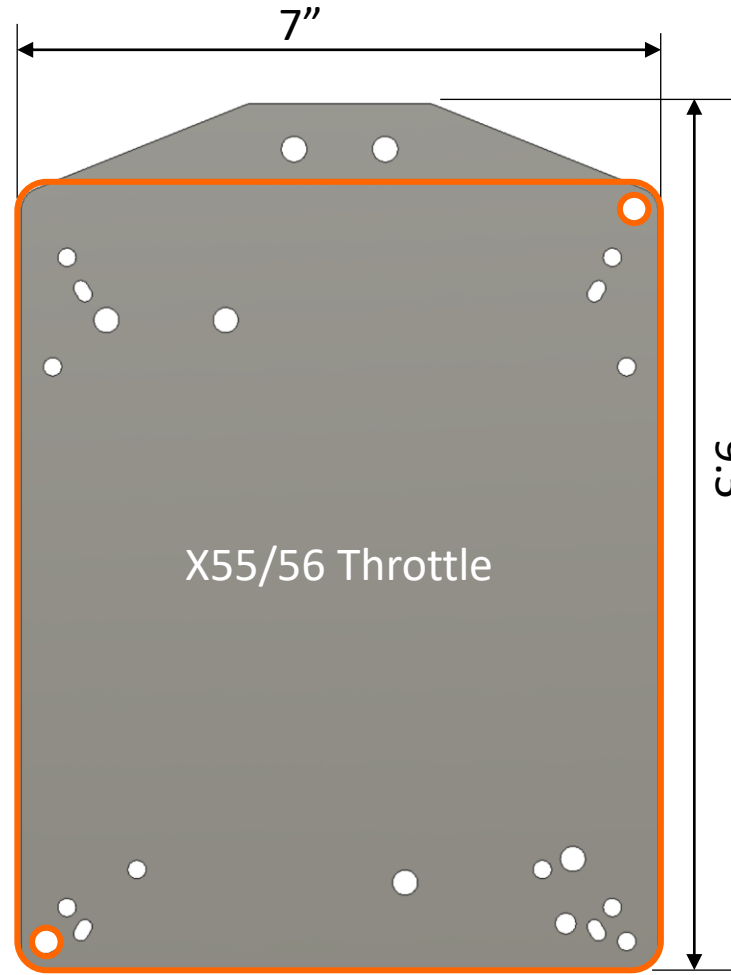
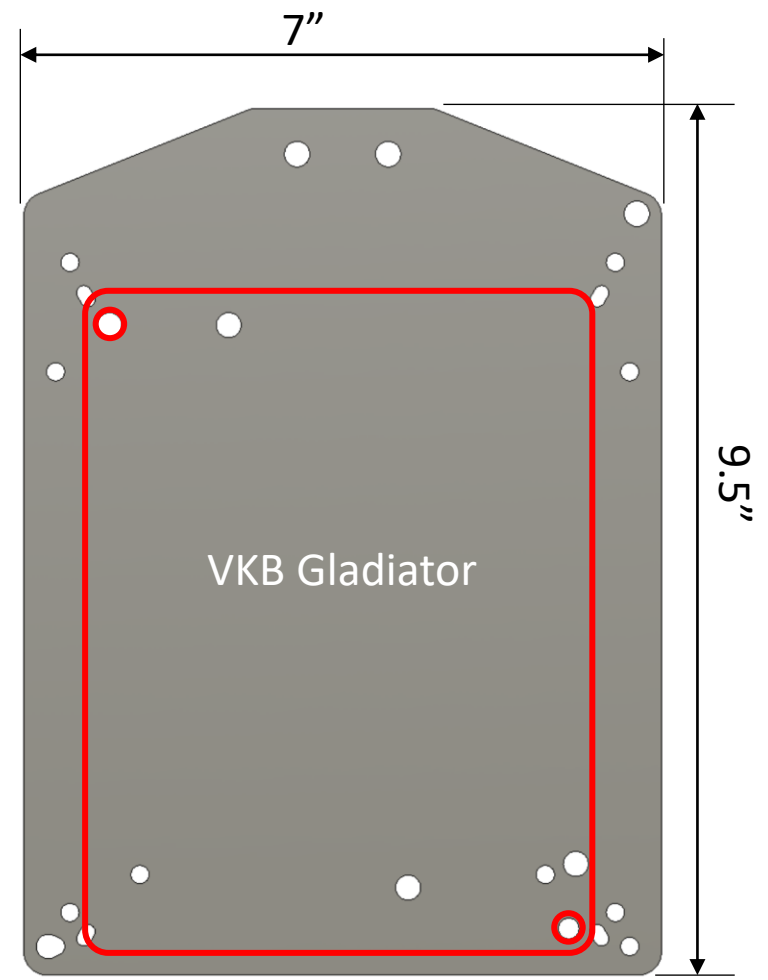

Plate C VKB Gladiator



Note, you will only use **two** of the four screws to secure the Gladiator Base to the plate



Fastener Kit: Common #10

- A** 1/4-20 x 3/8" Button Head Cap Screw (Qty 2)
- B** 1/4-20 Economy Slide Nut (Qty 2)
- C** #10-32 x 5/8" Socket Head Cap Screw (Qty 4)
- D** #10-32 Nut (Qty 4)

The fastener kit components are shown in two rows. The top row contains two button head cap screws (A) and two economy slide nuts (B). The bottom row contains four socket head cap screws (C) and four nuts (D).

Common Plate D

Supported Devices	Fastener Kit
CH Stick or Throttle	Velcro Strips
Thrustmaster T16000M	T16000M
Thrustmaster TWCS	T16000M
Thrustmaster Warthog Throttle	Common #10
Virpil MT50/MT50CM Throttle	Common #10
Virpil MT50CM2/CM3 Throttle ⁽¹⁾	Common #10

1) Attaches using 2 of the holes on the underside of the MT50CM2/3. This is meant for forward compatibility when upgrading. If you're buying a mount specifically for the CM2/3, I would suggest a Plate C or Plate E instead as it's a better fit.

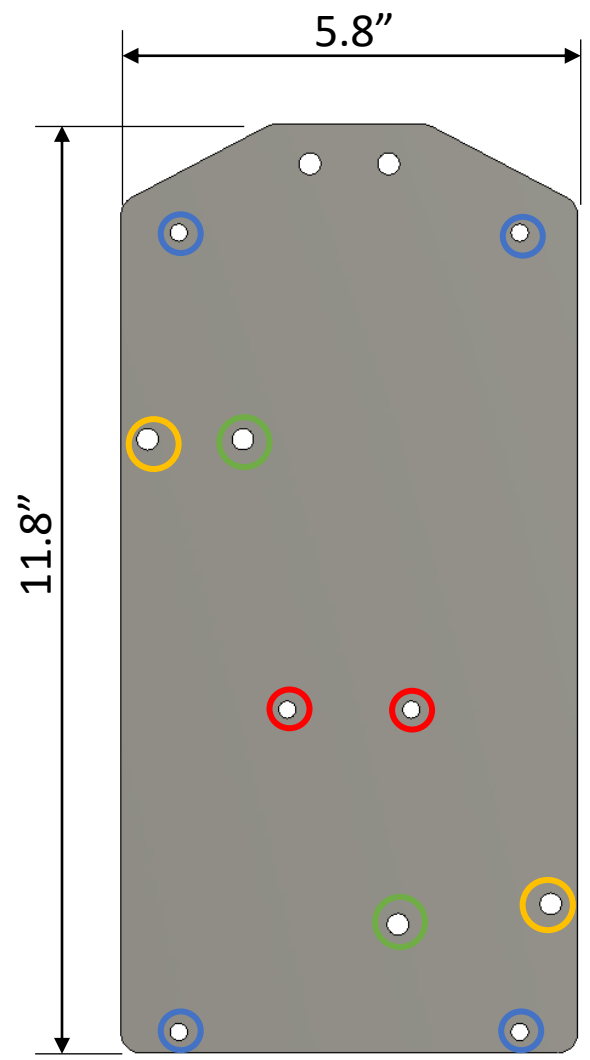
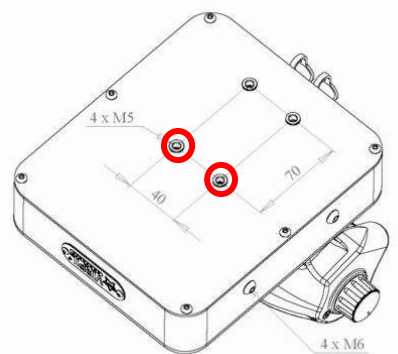
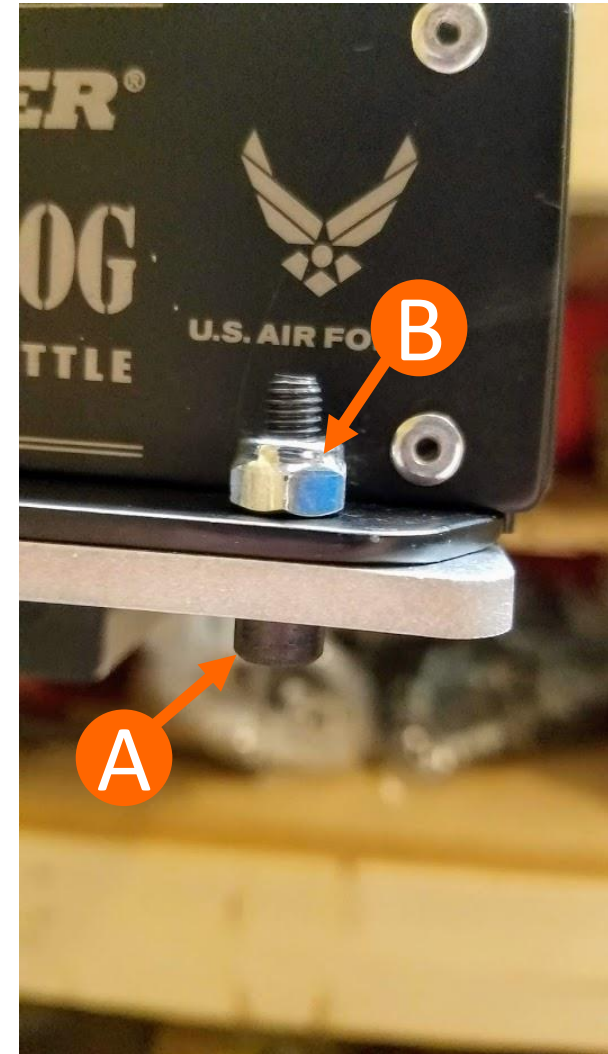

Plate D

Thrustmaster Warthog Throttle [Plate D] or Virpil MT50 Throttle (Original/CM) [Plate D]

- Place the throttle onto the mounting plate, and align the holes on the flanges of the throttle, front and back, with the holes on the plate.
- Insert screws [A] through the holes and tighten with nuts [B]. The screws use the same hex key that comes with the desk mount. The nuts you can hold by hand, or use an adjustable wrench.
- The same process can be used on an older full size Virpil Throttle (Original or CM)



Fastener Kit: Common #10

- A** #10-32 x 5/8" Socket Head Cap Screw (Qty 4)
- B** #10-32 Nut (Qty 4)
- C** 1/4-20 x 3/8" Button Head Cap Screw (Qty 2)
- D** 1/4-20 Economy Slide Nut (Qty 2)

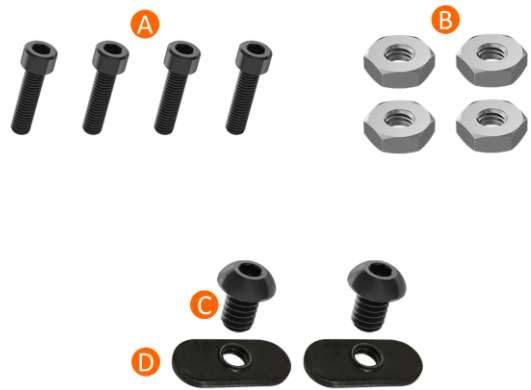

Common Plate E

Supported Devices:

- Virpil MT50/MT50CM
- Virpil MT50CM2/CM3





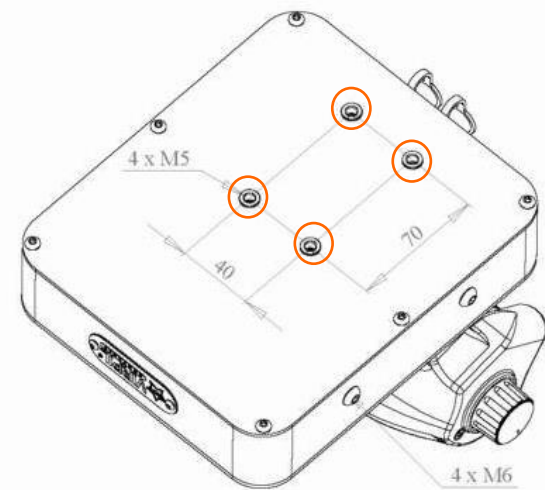
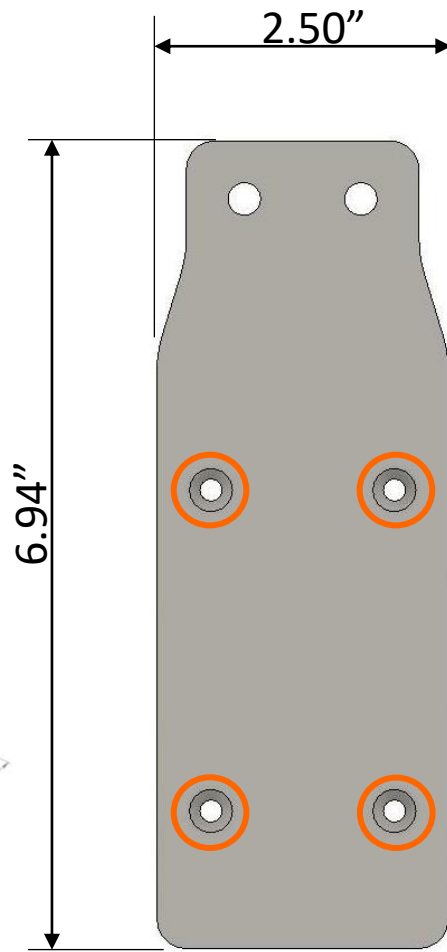
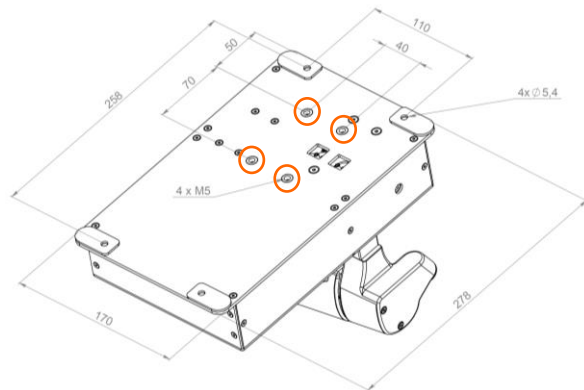

Fastener Kit: Plate E

- A** 1/4-20 x 1/2" Button Head Cap Screw (Qty 2)
- B** 1/4-20 Economy Slide Nut (Qty 2)
- C** M5x0.8 x 14mm Flat Head Screw (Qty 4)



Foxx Mount - Common Plate Cross-Compatibility Matrix

Device	Foxx Mount Plate Type				
	Plate A	Plate B	Plate C	Plate D	Plate E
					
CH Stick or Throttle			With Velcro	With Velcro	
Logitech X52/X52 Pro Stick or Throttle			X		
Logitech X55/56 Stick or Throttle			X		
Realsimulator FSSB R3	X	X			
Thrustmaster Cougar Stick			X		
Thrustmaster Cougar Throttle			X		
Thrustmaster T.Flight Hotas X Stick or Throttle			With Velcro		
Thrustmaster T16000M			X	X	
Thrustmaster TWCS			X	X	
Thrustmaster Warthog Stick	X	X *			
Thrustmaster Warthog Throttle				X	
Virpil MT50 Throttle (Original/CM)				X	X
Virpil MT50CM2/CM3 Throttle			X	X	X
Virpil Stick (T50/T50CM2/WarBRD)		X			
VKB Gladiator			X		
VKB Gunfighter	X	X			