

zappi

eco-smart EV charge point



operation & installation manual

MODELS:

ZAPPI-32A1P1T05

ZAPPI-32A1P1T08

ZAPPI-32A1P2T05

ZAPPI-32A1P2T08

myenergi.uk

Rev 1.2 October 2017

Contents

Introduction.....	4
Safety.....	4
Overview.....	5
Operation.....	7
Controls & Indicators.....	7
Display.....	8
Status Screens.....	10
Charging Modes.....	11
Manual Boost.....	12
Smart Boost.....	13
Boost Timer.....	14
Lock Function.....	15
Menus.....	16
Main Menu.....	16
Advanced Menu.....	17
Configuration.....	19
Advanced Settings.....	19
Linking Devices.....	20
Installation.....	22
Mounting.....	22
Wiring.....	23
Supply Connection.....	25
Sensor Installation.....	26
eSense Input (economy tariff).....	29
Fitting the Cover.....	30
Setup.....	31
Troubleshooting.....	32
Faults.....	33
Warranty.....	34
Technical Specifications.....	35



Introduction

Thank you for choosing **zappi**. Of course, we think you have made an excellent choice and are sure you will be very happy with the features, benefits and quality of this **myenergi** product.





These instructions will help you to familiarise yourself with the **zappi**, by reading the instructions, you will be sure to get the maximum benefit from this 'eco-smart' device.

Safety

The device has been manufactured in accordance with the state of the art and the recognised safety standards. However, incorrect operation or misuse may result in:

-  Injury or death to the operator or third parties
-  Damage to the device and other property of the operator
-  Inefficient operation of the device

All persons involved in commissioning, maintaining and servicing the device must:

-  Be suitably qualified
-  Have knowledge of and experience in dealing with electrical installations
-  Read and follow these operating instructions carefully
-  Always disconnect the device from the supply before removing the cover

The device is not to be used by persons (including children) with reduced physical, sensory or mental capabilities, or lack of experience and knowledge, unless they have been given supervision or instruction concerning use of the device by a person responsible for their safety.

Disposal

In accordance with European Directive 2002/96/EC on waste electrical and electronic equipment and its implementation in national law, used electrical devices must be collected separately and recycled in an environmentally responsible manner. Ensure that you return your used device to your dealer or obtain information regarding a local, authorised collection and disposal system. Failure to comply with this EU Directive may result in a negative impact on the environment.

Copyright

Copyright of these operating instructions remains with the manufacturer. Text and images correspond to the technical level at the time of going to press. We reserve the right to make changes. The content of the operating instructions shall not give rise to any claims on the part of the purchaser. We are grateful for any suggestions for improvement and notices of errors in the operating instructions.

Overview

Microgeneration systems such as Solar PV and small wind turbines are at their most efficient when the generated energy is consumed on-site rather than exporting it to the grid. This is what we call 'self-consumption'.

zappi is a Mode 3 charging station, compatible with all electric vehicles that comply with SAE J1772, EN62196 and EN61851 plug-in electric vehicle standards.

zappi works like any regular charging point but has special eco charging modes which will benefit homeowners with grid-tied microgeneration systems, like wind or solar generation. Two special ECO charging modes automatically adjust charging current in response to on-site generation and household power consumption. In FAST charge mode, **zappi** operates like an ordinary EV charging.

A grid current sensor (supplied) simply clips around the incoming supply cable. This sensor is used to monitor excess power and when using the special ECO charge modes, **zappi** automatically adjusts the charge rate in response to available surplus.

Feature Set

- Available with Type 1 or Type 2 connector
- 3 charging modes: ECO, ECO+ & FAST
- Optimises microgeneration self-consumption
- Works with solar PV or wind turbine systems
- Economy tariff sense input
- Programmable timer function
- Charge and event logging
- Remote control and monitoring add-on option
- Pin-code lock function
- Tap operated display backlight
- Built-in RCD protection
- Integral cable holster
- Supplied with clip-on grid current sensor

Overview Diagram

The diagram over the page, shows the **zappi** as part of a complete energy management system. Other **myenergi** products are shown and how they integrate with the grid connection and the microgeneration system.

Overview Diagram

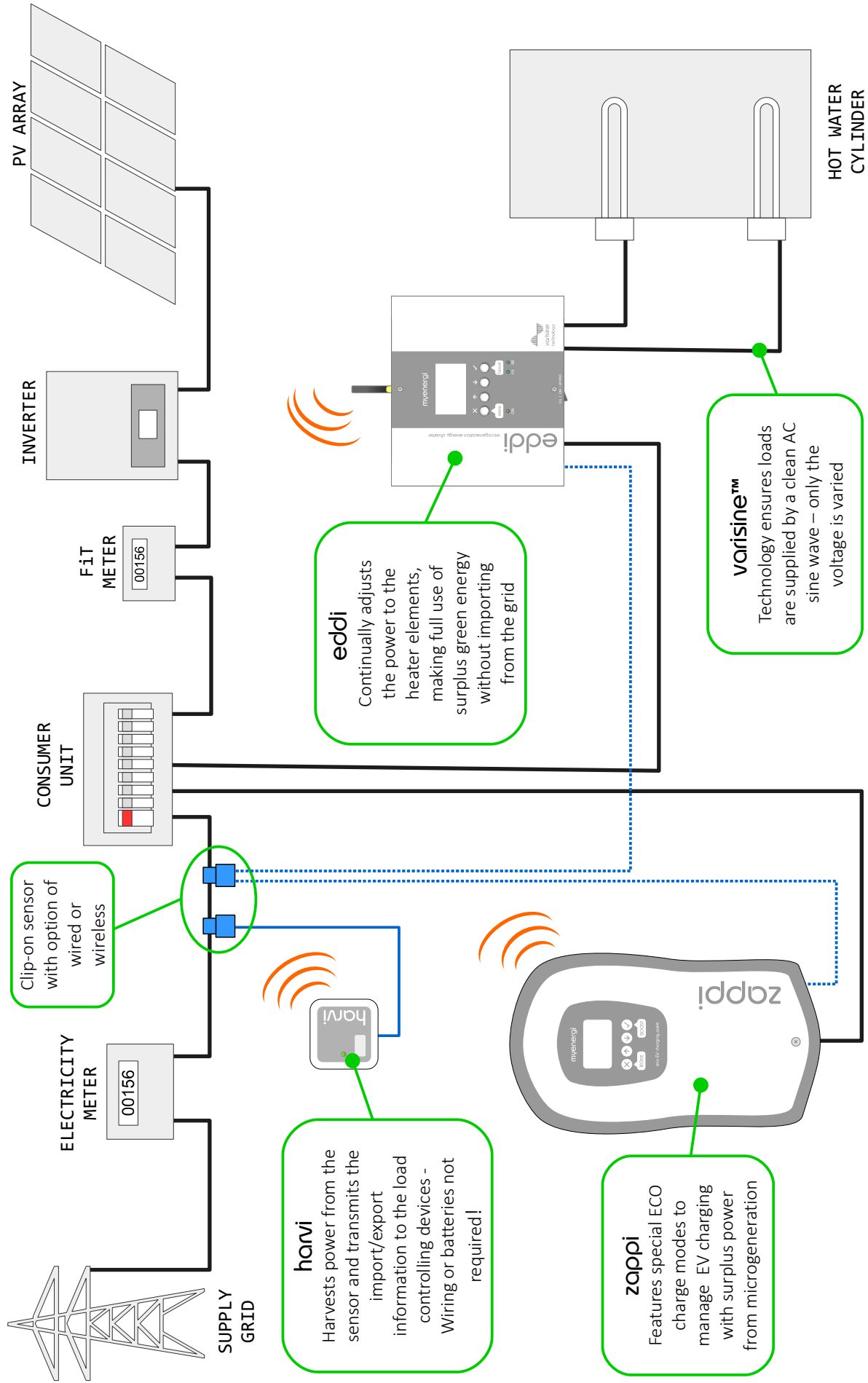

Operation

Controls & Indicators

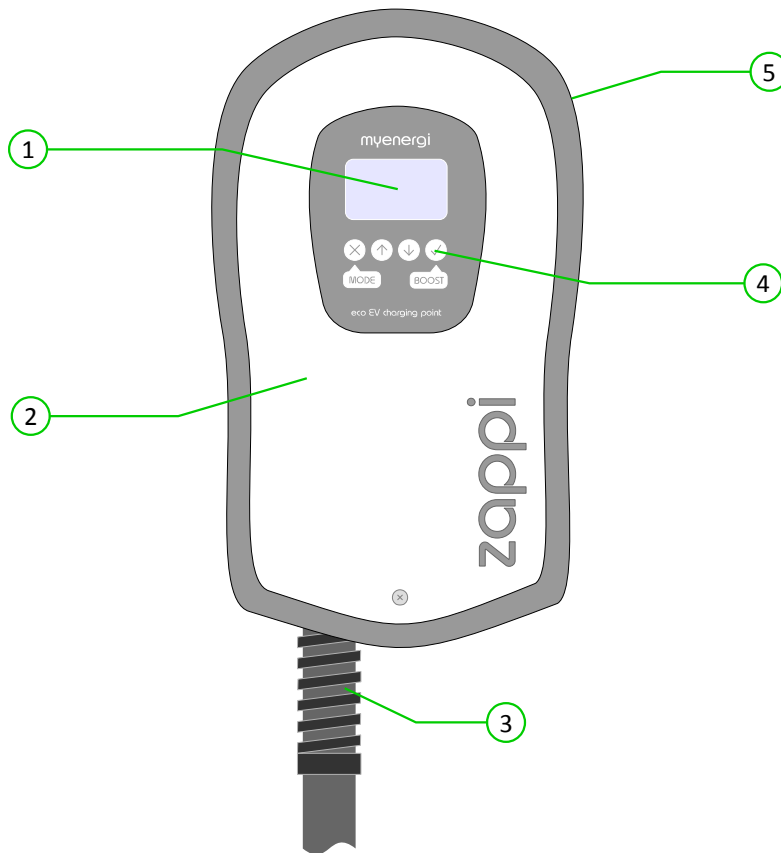





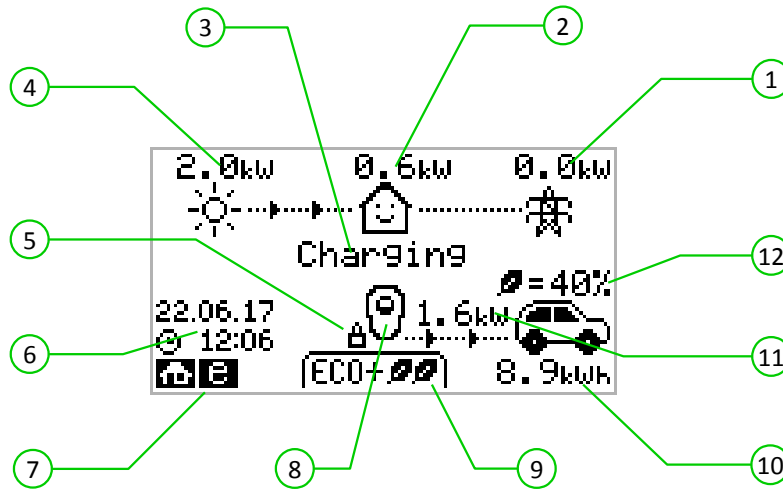





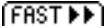



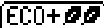



1	Display	Graphical LCD display with LED backlight
2	Front Cover	The white front cover hides the enclosure screws
3	Tethered Charging Cable	The charging cable is 5m or 8m and is fitted with Type 1 or Type 2 plug
4	Control Buttons	Four tactile buttons used to navigate the menus and alter settings: <ul style="list-style-type: none"> ⊗ Change charging Mode Exit current menu ↑ Enter Menu Move up a menu item Increase value ↓ Enter Menu Move down a menu item Decrease value ✓ Boost Select item Confirm value and move to next setting
5	Integrated Cable Holder	When not in use, the charging cable should be wrapped around the unit

Display



<p>1 Import / Export Power</p>	<p>The power being either imported or exported from or to the grid (kW). The direction of the arrows indicate if the property is currently importing power (left) or exporting power (right)</p> <p>The size of arrows is proportion to the level of power. When the property is neither importing or exporting power, the figure will be 0.0kW and there will no animated arrows. The property is then said to be 'in balance'</p>
<p>2 House Load Power</p>	<p>The power that the property is currently using in kW</p> <p>It does not include any surplus power being sent to the heater(s)</p> <p><i>Note: This is displayed only when the Generation Sensor is installed (either connected to CT2 input or a harvi device)</i></p>
<p>3 Status Text</p>	<p>The current status is displayed here (see <i>Status Screens</i> page 10)</p>
<p>4 Generation Power</p>	<p>The power being generated at this time in kW</p> <p><i>Note: This is displayed only when the Generation Sensor is installed (either connected to CT2 input or a harvi device)</i></p>
<p>5 Lock Icon</p>	<p>Operation lock is active</p>
<p>6 Date & Time</p>	<p>The current date and time</p>
<p>7 Mode Icons</p>	<p>These icons indicate that the import limiting is active (house) or the e-Sense input is live (e)</p>
<p>8 zappi Icon</p>	<p>This zappi unit. If there are wavy lines above the icon, the unit is thermally limiting (the output power will be temporarily reduced)</p>
<p>9 Charge Mode</p>	<p>Shows the selected Charging Mode; FAST, ECO or ECO+ (see <i>Charging Modes</i> page 11)</p>
<p>10 Charge Delivered to EV</p>	<p>The accumulated charge energy that has been sent to EV in this charge session</p>
<p>11 Current Charging Power</p>	<p>When the EV is charging, arrows will show here along with the charging power in kW</p>
<p>12 Green Level of last charge</p>	<p>This is percentage of 'Green' energy for the last charge session, this is shown at the end of a charge or when the EV is unplugged</p>

Display Icons Key

	House Consumption – Not Importing		Charge Mode = FAST
	House Consumption – Importing		Charge Mode = ECO
	Solar Generation Power		Charge Mode = ECO+
	Wind Generation Power		zappi Device – Normal
	Grid Power – Import / Export		zappi Device – Too Warm (output limited)
	Power Flow Direction – Small Amount		Import Power Limiting Active
	Power Flow Direction – Medium Amount		Economy Tariff Electricity Available
	Power Flow Direction – Large Amount		Current Charging Power
	Waiting For Surplus Power		Energy sent to EV for this charging
			Warning – refer to text on screen

Status Screens

EV Disconnected



The EV is not connected to zappi

In this example the last charging session delivered **20.8kWh** of energy to the EV and **80%** of that energy came from the solar panels.

Waiting for Surplus...

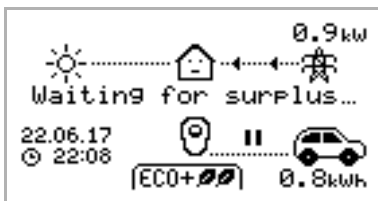

zappi is waiting for sufficient surplus power from the microgeneration system. This screen will be shown in ECO+ mode as it's only in this mode that charging will stop if there is not enough surplus power.

The house in the centre is straight-faced as grid electricity is being used by the house (**0.9kW** is this example).

Waiting for EV...



zappi is waiting for the EV to respond; the EV is not ready to accept charge.

Paused...

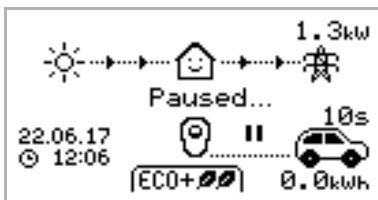

zappi is paused for a few seconds in order to limit the start/stop frequency during ECO+ mode charging.

The **Start/Stop Delay** can be changed in the **Charge Settings/ECO+ Settings** menu option.

Charging

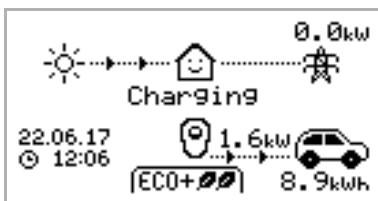

The EV is charging.

In this example the car is charging in ECO+ mode at **1.6kW**, there is no import or export from the grid (**0.0kW**) and the EV battery has charged by **8.9kWh** since the car started.

Charge Complete

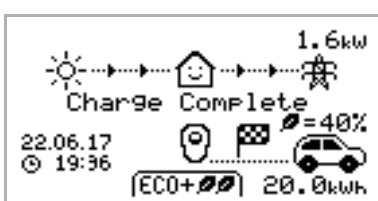

The EV is fully charged.

The charge energy used during the last charge is displayed at the bottom right (**20.0kWh** in this case) and the 'green contribution' is also shown (**40%** in this example).

Charging Modes

zappi has three different charging modes which can be selected simply by pressing the  button when the main screen is showing. The charge mode can be changed before or during a charge.



Regardless of the charge mode used, all of the surplus electricity is used but zappi's special **eco** charge modes, limit the amount of grid electric used. Below is explanation of each of the three charging modes.

FAST

Charges at the fastest rate.



Fast Mode will charge the EV at the fastest rate and will import grid electricity if there is insufficient surplus generated power.

The actual charge rate is dependant on the EV's onboard charger and the grid supply voltage. Typically, vehicles have either a 3.3kW or 6.6kW charger. The actual power can be a little different if the grid supply voltage is not exactly 230V.

zappi will deliver up to 7kW provided the supply connection is suitably rated.

ECO

Adjusts the charge rate to limit the use of grid electricity.



The charge rate is continuously adjusted, in response to changes in generation or power consumption elsewhere in the home, thereby minimising the use of grid power.

Charging will continue until the vehicle is fully charged, using available surplus power.

However, if at any time, the available surplus power falls below 1.4kW, the shortfall will be drawn from the grid.

Note: The EV charging standard does not support charging below 1.4kW.

ECO+

Adjusts the charge rate to limit the use of grid electricity and will pause the charge if there is too much grid electricity being used.

The charge rate is continuously adjusted, in response to changes in generation or power consumption elsewhere in the home, thereby minimising the use of grid power.

Charging will pause if there is too much imported power, continuing only when there is enough surplus power available.



The surplus power threshold at which the charge will start or stop can be set in the **ECO+ Settings** option, which is found in the **Charge Settings** menu.

It is possible to charge the EV using only surplus renewable power, providing there is sufficient surplus power to do so. To do this, set the **Min Green Level** to **100%**.

The **Min Green Level** is the minimum level for the contribution of green energy at the end of the charge. The actual green contribution for the charge, is displayed when the charge is complete or the EV is disconnected. For example: With **Min Green Level** set to **50%**, charging will be paused if 700W of power is being imported from the grid and will resume charging when there is 700W of power being exported.

Note: The EV charging standard does not support charging below 1.4kW.

Manual Boost

The Manual Boost function can only be used when charging in ECO or ECO+ mode. When boosting, the charge rate is set to maximum (just like FAST mode), until a set amount of energy has been stored in the EV's battery. After which, zappi will revert back to ECO or ECO+ mode.

This function is useful if you arrive home with an almost flat battery and would like to charge the vehicle immediately to ensure there is enough charge for a short trip if needed.

The amount of energy (kWh s) the boost uses can be changed in the **Charge Settings/Boost** menu.

When in ECO or ECO+ mode, each press of the  button will cycle through the boost options as illustrated below:

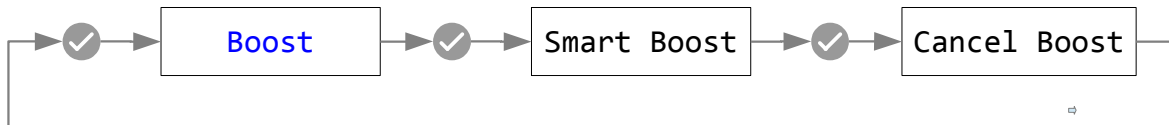

Activating Boost

1. When charging in ECO or ECO+ mode, press  until **BOOST** is shown.
2. The boost will start after a couple of seconds and the display will show the remaining boost energy.

The boost duration can be altered (when a boost is not in progress) in the **Charge Settings/Manual Boost** menu option.

Cancelling Boost

The boost can be cancelled by pressing  until **Cancel Boost** is shown.

Smart Boost

The Smart Boost function will charge the EV with a minimum kWh figure by a set time. Smart Boost is available only in ECO and ECO+ modes.

When in ECO or ECO+ mode, each press of the  button will cycle through the boost options as illustrated below:

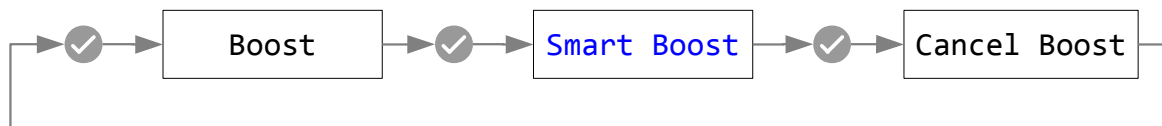

Example: It's a sunny Sunday and you wish to ensure there is enough charge in the EV to get to work in the morning (e.g. 15kWh), but in the meantime, you want to use the surplus energy from the PV system to charge the car, so you choose to use ECO+ mode. At sunset there was only 10kWh of charge accumulated. However, because you activated **Smart Boost**, and set the time you needed to leave for work, zappi automatically boosted the charge in the night to top up the battery to the required 15kWh by 7am.

Activating Smart Boost

1. When charging in ECO or ECO+ mode, press  until **SMART BOOST** is shown.

2. The **SMART BOOST** icon will show including the set energy amount in kWh s and the target time, (17kWh s and 7am respectively, in this example screen shot).

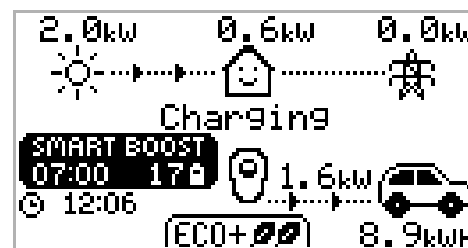

3. zappi will then test the EV for a few seconds, to determine the maximum charge rate.

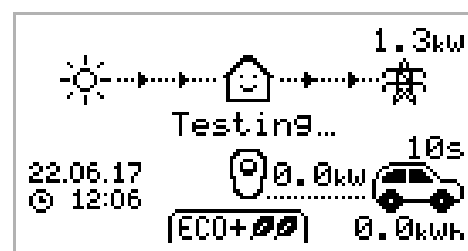

4. The boost will start at the latest possible time to achieve the set energy amount, if the current charge session has already accumulated enough energy, the boost will not be required and so will not operate.

The required energy and target time can be altered only when Smart Boost is not active. These settings are in the **Charge Settings/Smart Boost** menu option.

Boost Timer

When using ECO or ECO+ charge modes, **zappi** can be programmed to 'boost' the current charge at certain times. When boosting, the charge rate is set to maximum (just like FAST mode), regardless of the amount of available surplus power. This means that power may be drawn from the mains grid supply during boost times.

There are four editable time slots which can be set to operate for certain days of the week.

Setting the duration to **0h00** will make the boost inactive.

Programming Boost Times

1. From the main screen, press **↑** or **↓** to enter **Main Menu**
2. Select **Boost Timer** from within the **Charge Settings** menu. The **BOOST TIMER** screen is then shown.
3. The boost can now be edited: Use **↑** or **↓** buttons to highlight the time slot you wish to change. The screen below shows the start hour being edited:
4. Alter the start hour with the **↑** or **↓** buttons and then press **✓** to move to minutes.
5. Edit the duration in the same way and then press **✓** again to edit the days of the week you want the boost to be active for; each day of the week and by toggled on/off with **↑** or **↓** buttons, press **✓** to go to the next day. Pressing **✓** on the last day (Sunday) will confirm the boost time slot and whole line will be highlighted again.
6. Press **✕** to exit the **BOOST TIMER** screen.

Start	Dur	Days
07:30	1h30	MTWTF--
08:00	0h15	MTWTF--
12:00	0h00	-----SS
17:00	0h00	-----SS

Start	Dur	Days
07:30	1h30	MTWTF--
08:00	0h15	MTWTF--
12:00	0h00	-----SS
17:00	0h00	-----SS

Economy Tariff Boosting

Boosting only when economy rate electricity is available can be achieved in one of three ways:

1. By setting the boost timer to coincide with the economy tariff times. This option should be used only if the electricity meter is a dual-rate meter (modern meters usually are).
2. Boost only at set times if economy rate electric is available.
3. Automatically boost whenever the economy tariff rate electricity is available, regardless of boost times.

Options 2 and 3 are available only when using the eSense input.

For option 1, the **eSense Input** in the **Advanced** menu should be set to **Boost Timer Enable**.

With the **Boost Timer Enable** function set, the **BOOST TIMER** screen will include an extra column (see screenshot). The **e** can be toggled on/off, if **e** is present, the boost will activate only when the boost times are valid and the economy rate tariff is available.

Start	Dur	Days
e 07:30	1h30	MTWTF--
- 08:00	0h15	MTWTF--
- 12:00	0h00	-----SS
- 17:00	0h00	-----SS

Alternatively the eSense input can be used to active the boost whenever the economy tariff rate electricity is available, regardless of boost times (option 2). To do this, the **eSense Input** option in the **Advanced** menu should be set to **Boost**. When using this option, the Boost Timer is not needed.

Boost Time Conflicts

If one or more boost times conflict, the boost will follow the latest time or longest duration.

Lock Function

zappi can be locked from unauthorised operation. The Lock Function requires a pin number to be entered before the unit can be operated. The lock can be set to be active only when the EV is plugged in or only when unplugged, it can also be set to be always active.

The settings for the Lock Function can be found in the **Other Settings/Lock Function** menu option.

Lock Function Setting	Description
EV plugged	The Lock Function is active when the EV is plugged in, preventing tampering with the charge session or changing any settings
EV unplugged	The Lock Function is active when the EV is disconnected, preventing unauthorised charging
Timeout	The time before the Lock Function automatically reactivates after being unlocked
Lock Code	This is the current lock code and is five digits from (1 to 4), it can be changed here
Auto Hide	If set, this will hide the main display of the zappi to keep the power readings private

Menus

Main Menu

Main Menu Options		Description	
Charge Log...	Today...		
	Yesterday...		
	Week...		
	Month...		
	Year...		
	Total...		
Event Log...	Today...		
	Yesterday...		
	Week...		
	Custom Date...		
Readings...	READINGS 1/3	Status:	Current status of the unit
		Exporting: Importing:	Power being imported or exported, from or to the grid respectively
		Charge Power:	Power level in Watts being supplied to the EV
		Pilot (PWM):	Control Pilot PWM
		Charge Current:	AC current supplied to the EV
		Unit Temp:	Internal temperature of the zappi unit
	READINGS 2/3	Voltage:	Supply voltage to the unit
		Voltage Max:	Maximum supply voltage since switch-on
		Voltage Min:	Minimum supply voltage since switch-on
		Frequency:	Grid frequency
		Exporting: Importing:	Power being imported or exported, from or to the grid respectively
	READINGS 3/3	Grid Current:	AC current at grid connection point, including reactive currents
		Exporting: Importing:	Power being imported or exported, from or to the grid respectively
		Generation:	Power from the generator (if available)
		Consumption:	Power consumed by the house (if available)
		Diverting:	Total diverted power (inc. all devices)
		Charge Power:	Current power being supplied to the EV
		Charge Energy: Charge Time:	Energy supplied to EV during current charge session Duration of current charge session
Information...	INFORMATION 1/2	Status:	Status of the unit
		Serial No:	Serial number of the unit
		Firmware:	Firmware version installed in the unit
		Assembled:	Factory assembly date
		Cal Date:	Calibration changed date
		Power Fail:	Time and date of last supply failure
	INFORMATION 2/2	Grid Sensor:	Grid current sensor source
		Signal Quality:	RF signal reception quality
		Last Fault:	Last recorded fault code
		Fault Date:	Date and time of last recorded fault code

Main Menu Options		Description		
	INFORMATION 3/3	Network ID:	Network information for this device when linked to other devices using RF network (Only shows if connected to other devices)	
		Device Address:		
		Master Address:		
		Channel:		
		EUI:		
Linked Devices Info...		Status information from all linked devices See <i>Linking Devices</i> page 20 for details		
Charge Settings...	ECO+ Settings...	Min Green Level:	ECO+ charge mode settings. See <i>Charging Modes</i> page 11	
		Start/Stop Delay:		
	Manual Boost...		Manual Boost settings. See <i>Manual Boost</i> page 12	
	Smart Boost...		Smart Boost settings. See <i>Smart Boost</i> page 13	
Boost Timer...		Programmable boost times. See <i>Boost Timer</i> page 14		
Other Settings...	Time & Date...	Time:	Set current time in 24 hour format	
		Date:	Set date in Format (see below)	
		Format:	Sets the date format	
		Auto DST:	Automatic Daylight Saving Time adjustment	
		DST Zone:	Set zone for Daylight Saving Time	
	Display & Sound...	Language...		Set language for the main screen and menus
		Icons...	Generation:	Generation icon can be sun or wind
			Monitoring:	If the is on generation on-site then generation monitoring can be switched off
		Backlight...		Set the duration the display backlight remains on after a button press
	Contrast...		Set the display contrast	
	Set Buzzer:		Switches ON or OFF the buzzer for button presses and mode changes	
	Lock Function...	EV plugged:		Lock is active only when EV is plugged in
		EV unplugged:		Lock is active only when EV is unplugged
		Timeout:		Length of time for the lock to reactive after unlocking
		Lock Code:		The lock code can be changed here
		Auto Hide:		Hide the main screen when zappi is locked
	Advanced...		Advanced menu and settings (passcode protected) Default passcode: 0 0 0 0	

Advanced Menu

Advanced Menu Options		Description
Supply Grid...	Use Phase:	Set the supply phase to use for this device – see <i>Advanced Settings</i> page 19 for more information
	Supply Current:	Set the available supply current to 16A or 32A – see <i>Advanced Settings</i> page 19 for more information
	Export Margin:	Minimum level of export power which is maintained when zappi is diverting surplus power – see <i>Advanced Settings</i> page 19 for more information
	Grid Limit:	Maximum grid import power limit. When charging, the charge power is reduced to keep import below this level. This also applies when boosting – see <i>Advanced Settings</i> page 19 for more information
Linked Devices...	Devices...	Other myenergi devices can be wirelessly linked to zappi , this shows connected devices and their priorities. Settings for some devices are made here -

Advanced Menu Options		Description
		See <i>Linking Devices</i> (page 20)
	Pairing Mode...	Puts this zappi in pairing mode so it can be linked to another device - See <i>Linking Devices</i> (page 20)
	Add Device...	Add a myenergi device to the 'network'. See <i>Linking Devices</i> (page 20)
	Channel... RF Channel:	Sets the radio frequency channel number used when linking other devices - See <i>Linking Devices</i> (page 20)
	Reset Settings...	Clear all linked device settings. See <i>Linking Devices</i> (page 20)
CT Inputs...	CT 1:	Set the function of CT1 input Note: This must be set to 'Disabled' if the Grid Sensor is connected to Harvi
	CT 2:	Set the function of CT2 input
eSense Input...	Disabled	eSense input is disabled
	Boost	If the eSense input is live, zappi will boost the charge – see <i>eSense Input</i> page 19
	Boost Timer Enable	zappi will boost the charge if eSense is live AND the boost timer is set to operate at that time. see <i>Economy Tariff Boosting</i> page 14
Compatibility...	PF Responsive:	zappi will adapt to EV's with poor power factor (e.g. Renault Zoe).
	Min PWM:	Control Pilot PWM minimum limit
	Power Factor:	When PF Responsive is ON, the measured power factor must be better than this set value to enable lower charging current set by Min PWM
	End Charge Delay:	Charge Complete status is delayed by this time to allow access to the vehicle without starting a new charge session
	Infinite PWM:	Keeps zappi ready to restart charge after charge is complete – this is needed on some EV's when the user wants to preheat the vehicle in morning
Menu Passcode...		The code required to access the Advanced menu
Factory Reset...	Erase Config	Restore the configuration to factory default
	Erase Data	Clear all data from memory
	Erase ALL	Restore configuration to factory default and erase all data
	Confirm	Confirm restore options and re-boot device

Configuration

Advanced Settings

Supply Grid - Phase

The **Phase** setting is only used on 3-phase systems.

It should be set to match the phase number that the **zappi** is wired to so that the power measurements are correct and that the **zappi** responds to the correct phase when using the **harvi** wireless sensor.

An alternative setting is **ALL**, this tells the **zappi** to consider export power as available surplus irrespective of which phase the export power is actually on. This setting should be used only if you are sure the electricity meter is measuring the combined net power across the three phases.

Supply Grid – Export Margin

This sets a minimum level of export power which is maintained when **zappi** is charging in ECO or ECO+ modes.

Normally **Export Margin** would be set to **0W** (zero Watts) and all of the available surplus will be used to charge the vehicle, however, it is may be desired to have a minimum export level at all times.

Supply Grid – Grid Limit

Ordinarily the Grid Limit would be set to **OFF**, in some cases however, limiting of the grid import level can be an advantage.

For example a property may have a grid supply limit of only 12kW. 10kW is being consumed by other appliances and the user wants to charge the EV in FAST mode at 7kW. In this case, the total consumption (17kW) would exceed the maximum allowed import (12kW). However, with a **Grid Limit** setting of **12kW**, **zappi** would limit the charging power (to 5kW in this case) and therefore the maximum allowed import power will not be exceeded.

CT Inputs

The CT1 and CT2 inputs are configured depending on the connected sensors. See *Sensor Installation* page 26 for more information regarding the CT sensors.

CT1	Description
Disabled	CT1 is not connected this setting is used if the Grid Sensor is wired to a harvi device or if the zappi is acting a a slave unit
Grid	CT1 input is wired to the Grid Sensor
CT2	Description
Disabled	CT2 is not connected
Generation	CT2 input is wired to a Generation Sensor (generation power will be shown on the main screen)
Storage	CT2 is monitoring a storage system, e.g. battery or another energy diverter

eSense Input

The eSense input can be configured to automatically activate a Boost during ECO or ECO+ charging, whenever economy tariff electricity is available. The eSense input must be wired to a circuit which is live during the economy tariff times for this to function. See *eSense Input (economy tariff)* page 29 for wiring details.

eSense Setting	Description
Disabled	eSense input is ignored
Boost	If the eSense input is live, zappi will boost the charge
Boost Timer Enable	zappi will boost the charge if eSense is live AND the boost timer is set to operate at that time. see <i>Economy Tariff Boosting</i> page 14

Linking Devices

Up to six **myenergi** devices can be wirelessly linked to together. By linking more devices, you can use more of your own energy or have more control and visibility. Devices available now or soon to be available are:

zappi – An eco-smart electric vehicle charge point that can use surplus power to charge the car.

harvi – A self-powered wireless sensor that can be used along with **myenergi** load controlling devices such as **zappi** and **eddi** and is able to report the grid or generation power information to the other devices wirelessly, this can greatly simplify installation.

hub – The link between your **myenergi** devices and the internet, allowing remote monitoring and control.

Adding Devices

Adding a device is simple, it involves putting one device in **Pairing Mode** and selecting **Add Device** on another unit.

1. Navigate to the **Linked Devices** menu by selecting **Settings**, then **Advanced** and then **Linked Devices**
2. The device you want to add needs to be in Pairing Mode. This is done by either pressing the pair button or by selecting **Pair Mode** on the screen (depending on the actual device)
3. On the already installed load controlling device such as the **zappi** or **eddi**, select **Add Device** in the **Linked Devices** menu which is found the **Advanced Settings** menu
4. You will now see the **ADD DEVICE** screen and **zappi** will be searching for other devices which are on the same channel and are in Pairing Mode. Any devices found are listed along with their unique serial numbers
5. Select the device you want to add by highlighting the appropriate device using the **↑** and **↓** buttons and then pressing **✓**. The device will then be added and the screen will return to the previous menu

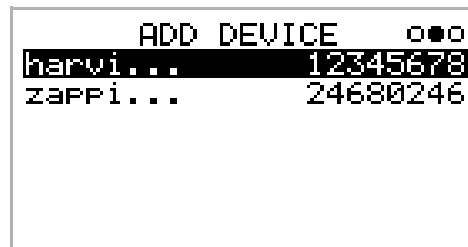
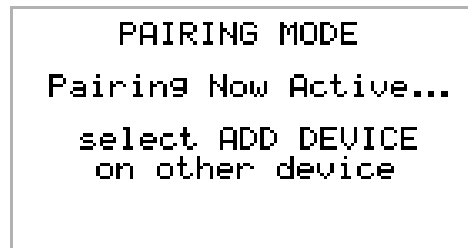

Channels

On rare occasions it is possible that there are other appliances operating on the same frequency which could cause interference. If it is not possible to link devices or the connection seems poor, changing the RF Channel may help. To do this make sure all devices are removed from the network by selecting **Reset Settings** in the **Linked Devices** menu and then select a different channel with the **Channel** menu option. Be sure to change the channel on the other devices before attempting to link them.

Removing Devices

A device can be removed by selecting it from the **Devices** menu and then selecting **Remove Device**.

Device Settings

Most device types have settings which can only be changed via the **Linked Devices** menu. For example, **zappi** and **eddi** have a settings for priority and **harvi** has settings to configure its CT inputs (see *Device Priorities* page 21).

The device settings are accessed through the **Linked Devices** menu; select **Devices** then select the appropriate device and press **✓** to bring up the devices' settings screen. Refer to the relevant devices' instruction document for more information regarding the actual device settings.

Device Priorities

The priority of each, load controlling linked device, can be set from any device with a display. This enables control of how the surplus energy is shared between them. The example below shows one **eddi** device, two **zappi** devices and one **harvi** on the same 'network'.

Serial	Device Name	Serial Number	Priority	Status
1	eddi...	12345670	~	
2	ZAPPI...	87654321		
2	zappi...	76543210		
	harvi...	24680246		?

All linked devices (1) are listed in the **DEVICES** screen, the device shown in CAPITAL letters is the device currently being viewed. The serial number of each device is shown on the right (2)

The priority is shown on the left of each load controlling device (3) with 1 being the highest priority. If two or more devices have equal priority, the available surplus (for that priority level) is shared equally between them.

The ~ symbol (4) indicates which device is the 'master' device which has the Grid Sensor connected to it.

If the ? symbol (5) is shown along side a device, it indicates that communication has been lost from the device.

Linked Devices Information

The current status of all linked devices, can be viewed together in the **LINKED DEVICES INFO** screen which can be found from the **Main Menu**.

Serial	Device Name	Priority	Power Output	Status
1	eddi		3070W	~
2	ZAPPI		4321W	⬆
2	zappi		1320W	⬆
3	eddi		170W	×
	hub			?

This screen lists all the linked devices (1) and the priority setting for each device (3) The current device is shown in CAPITAL letters. To the right of each device is the real-time output power level (2) The right side of the screen has symbols to show the status of each device (4) Refer to the table below for the meaning each symbol.

- Master device – the controlling device in the linked system
- Boost – the device is currently boosting
- Max – the device is at maximum output power
- Min – the device is at minimum controllable output power
- No Load – the device is not able to use surplus power as there is no load
- Communication problem – there is no response from the device

Installation Mounting

1. Remove the white front plate by unscrewing the M3 screw at the bottom and sliding it upwards before lifting it away.
2. Unscrew the 12 M4 screws now exposed and lift off the enclosure cover.
3. Offer the unit up to the wall and mark the holes for drilling. If fixing to a timber stud wall, you can use the two central vertically aligned fixing points (1) to screw the enclosure directly into the timber. The two additional mounting points (2) can be also be used if desired.

The supply cable entry can be via the rear grommet (3) or by drilling the enclosure at the bottom right (4) and using a suitable cable gland.

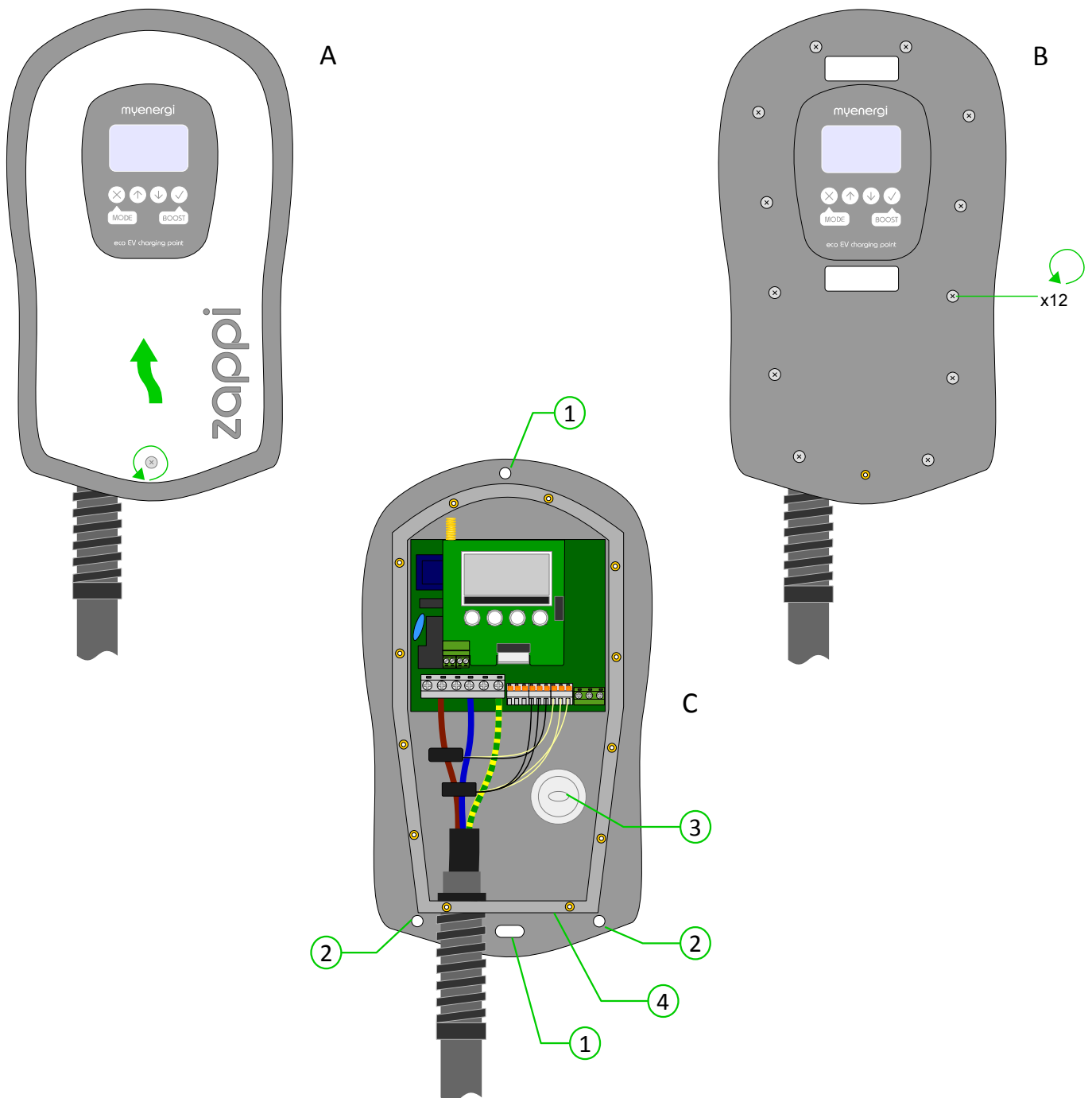

Wiring

Warnings

- ⚠️ **WARNING!** An electric shock can be fatal; electrical connection work may only be carried out by a competent person
- ⚠️ The earth conductor must be correctly installed and reliably connected
- ⚠️ This device must be equipped with an over-current protection device of maximum 40 Amps (B40)

Strip Length

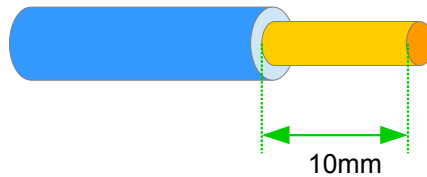

Overview Diagram

The diagram on the following page gives an overview of the basic wiring with respect to the grid supply and the microgeneration system.

Supply

The **zappi** device should be connected to a single-phase 230V or 240V nominal AC supply. The supply should be from a dedicated 32A or 40A circuit breaker.

Earthing

The unit must be earthed in accordance with local regulations, e.g. It may be a requirement to install an Earthing rod if the supply is PME.

Cable Entry

There is a grommet in the rear of the unit for through-wall cable installation. If however, the supply and/or sensors cables are surfaced mounted, there is space at the bottom right-side of the enclosure to drill holes for the cables. It is essential that correctly sized cable glands with a minimum IP65 rating are used.

Wiring Overview Diagram

The diagram on the following page gives an overview of the wiring required for a standard installation of the **zappi**.

Wiring Overview Diagram

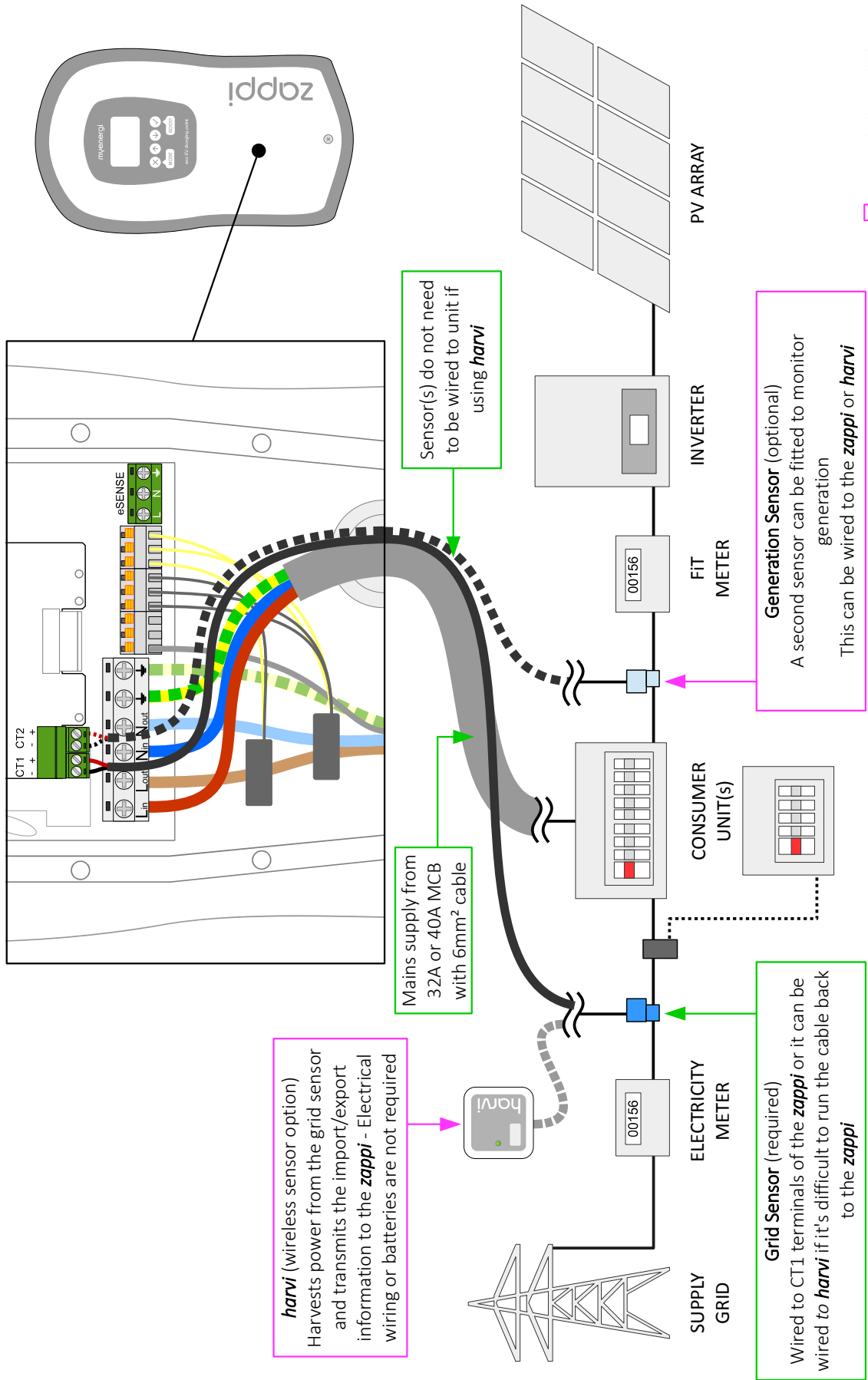

Supply Connection

The **zappi** device should be connected to a single-phase 230V or 240V nominal AC supply. The supply should be from a dedicated 32A or 40A circuit breaker.

zappi features an integral 30mA Type-A RCD, therefore an RCD protected supply is not required unless local regulations state otherwise.

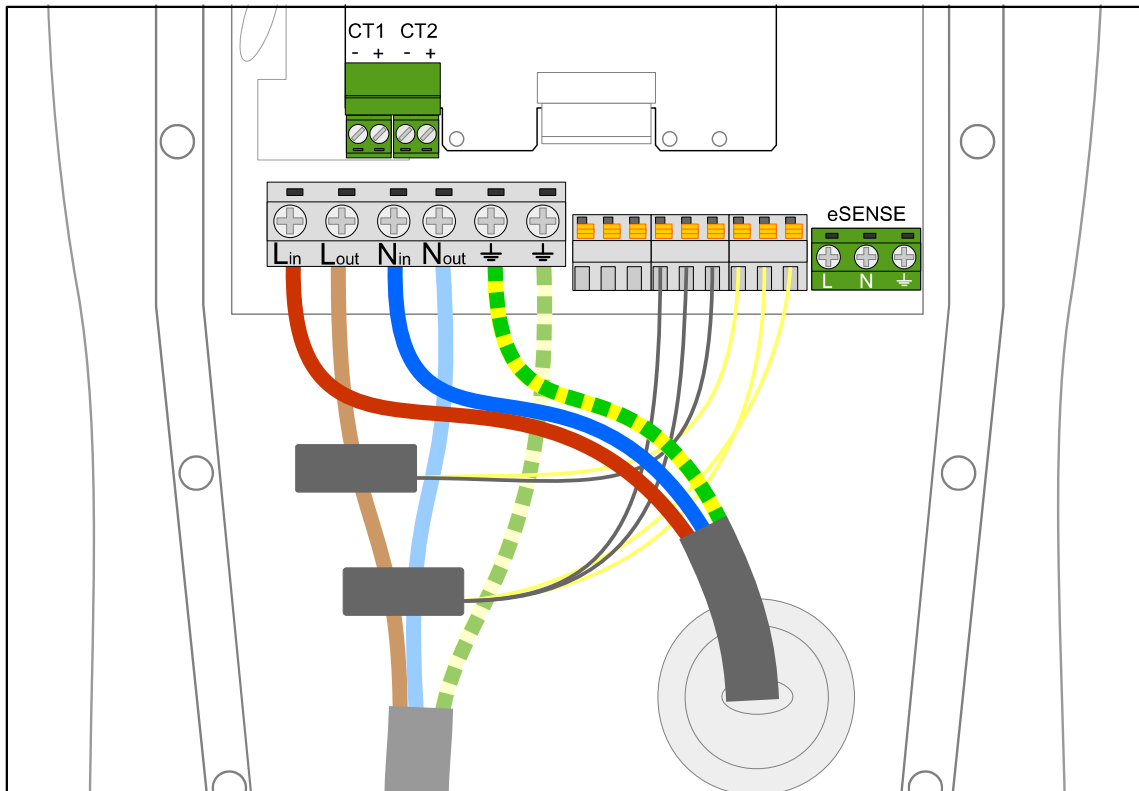

Sensor Installation

Grid Sensor Installation

The grid sensor (supplied) needs to be clipped around either the Live or Neutral meter tail of the electricity supply meter. If using the Neutral conductor, reverse the direction on the sensor.

The positioning of the sensor is crucial, take note of the following when deciding where best to install the sensor:

- ✓ Can be connected to either the **zappi** (wired sensor) or **harvi** (wireless sensor)
- ✓ ALL of the import and exported power must be 'seen' by the sensor – be sure to install it upstream of ANY junction box or 'Henley Block' (it can be fitted inside the consumer unit)
- ✓ The arrow on the bottom of the sensor must be pointing towards the consumer unit
- ✓ Ensure the sensor is fully closed and clicks shut
- ✓ Wire to the **CT1** connector of the **zappi**; black [-] and red [+]

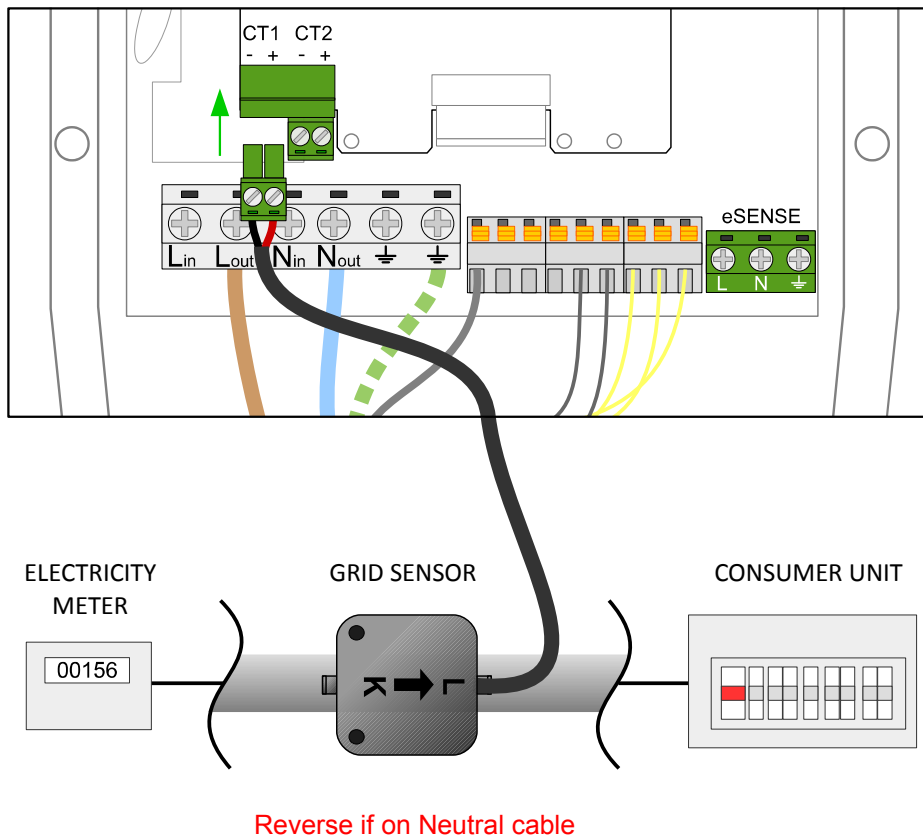

Extending the sensor cable

If there is a need to extend the sensor cable, twisted-pair cable like CAT5 or telephone cable must be used. DO NOT use mains cable, bell wire or speaker cable. It is important to use only twisted-pair cable to maintain signal integrity. The cable can be extended up to 100m.

Three-Phase Systems

If the supply is three-phase, the **zappi** device and its Grid Sensor must be on the same phase.

It is possible to net the export power across phases if using the **harvi** with three Grid Sensors. This allows the **zappi** to use surplus power from any phase and not just the phase which the **zappi** is installed on. However, you must be sure that the electricity is metered in such a way as to allow this.

Voltage Optimisers

If there is a voltage optimiser (VO) installed at the site, the sensor and the **zappi** must both be on the same side of the VO; either the incoming grid supply or the optimised supply.

Battery Storage Systems

Where there is an AC-side battery storage system, there can be a conflict as both the storage system and the **zappi** are effectively competing to consume the surplus energy. Whilst this is not necessarily an issue, the results can be somewhat unpredictable. To prevent this unpredictable behaviour, it is necessary to install an additional sensor to monitor the generation or the battery system, this will give control as to which device has priority.

This additional sensor should be wired to CT2 terminals of the **zappi** or a **harvi** device if wireless is required. And it should be clipped around the Live cable from the battery inverter. (See page 28) . During the setup process it will be necessary to change the setting for **CT2**; refer to *CT Inputs* on page 19 for details of the available settings.

The table below shows the sensor positioning and **CT2 Input** setting required to for the priorities to function as required.

Priority	Display	Sensor Positioning (CT2)	CT2 Input Setting
Battery Storage System	Generation Power is displayed above the generation icon on the main screen	Live cable to generation inverter (PV or Wind), with the arrow (L) pointing towards consumer unit. The sensor needs to 'see' all of the generation on site for this to function correctly	Generation
EV Charging	No addition information of the display	Live cable on AC battery system, with the arrow (L) pointing towards consumer unit	Storage

Third-Party Diverters

If there is a third-party energy diverter on site, it may be desirable for **zappi** to take priority over the diverter. This can usually be achieved by installing an additional sensor connected to the CT2 input. The sensor should be clipped onto the supply cable to the diverter with the arrow pointing towards it. The **CT2 Input** setting should be set to **Storage**.

Wireless Sensor Installation (optional accessory)

In some cases it can be difficult or impractical to install a wired sensor. For example it may be the case that the **zappi** unit needs to be connected to a sub-board, rather than main consumer unit and two consumer units are in different buildings.

The solution to is to install **harvi** – a clever little device that enables the **zappi** and **eddi** products to be installed without using a wired sensors for measuring the grid and or generation power; instead the sensor is connected to **harvi**. No power source is needed for **harvi** – the energy from the sensor is harvested and used to transmit the measurement signal to the **zappi** or **eddi**. This means batteries or electrical wiring are eliminated!

Up to 3 sensors may be used with **harvi** so one device can be used with Grid and Generation Sensors, it also supports 3-phase systems if three sensors are connected.

Refer to the **harvi** installation guide for details on installing and configuring **harvi** for your system.

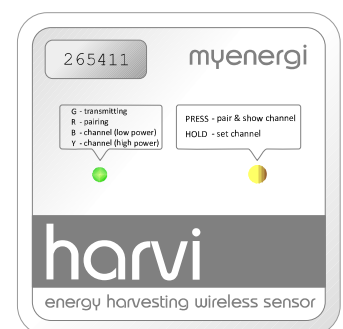

Generation Sensor Installation (optional accessory)

There is an option to add an additional sensor (available separately) for monitoring the generation. When this sensor is installed the main screen will detail the generated power and the total power consumption of the all the other appliances in the property.

The positioning of the sensor is crucial, take note of the following when deciding where best to install the sensor:

- ✓ Can be connected to either the **zappi** (wired sensor) or **harvi** (wireless sensor)
- ✓ The arrow on the bottom of the sensor must be pointing towards the consumer unit
- ✓ Ensure the sensor is fully closed and clicks shut
- ✓ Wire to the CT2 connector of the **zappi**; black [-] and red [+]

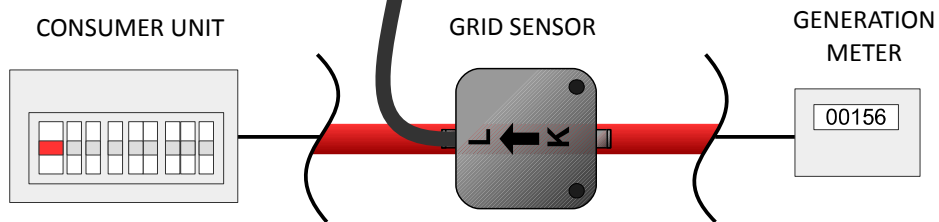
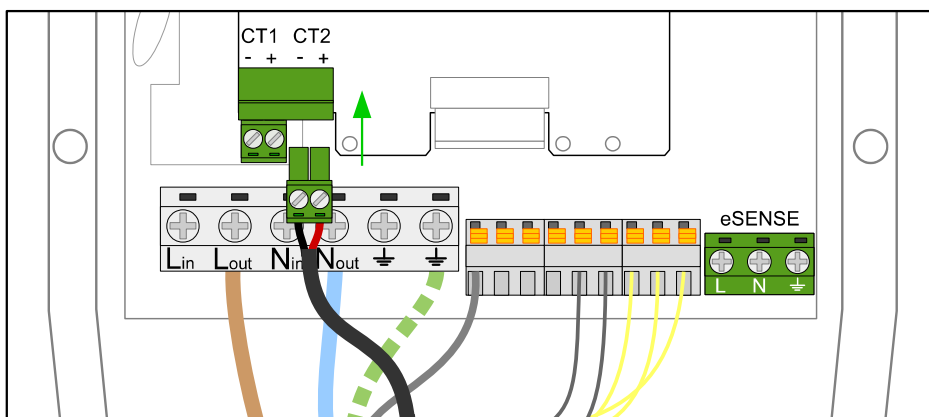

Reverse if on Neutral cable

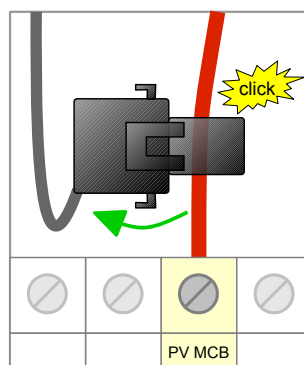

eSense Input (economy tariff)

zappi has an input which can be used to sense the availability of economy tariff electricity, this can be used to automatically boost the charge when in ECO or ECO+ charging modes.

The eSENSE input is electrically isolated and effectively draws no current so the cable size is not important. An AC voltage between 100V and 260V across the L and N terminals of the eSENSE input cause the economy tariff symbol **E** to be shown on the main screen. The eSENSE Earth terminal is not required to be connected.

See *eSense Input* on page 19 for details of how to configure the eSENSE input.

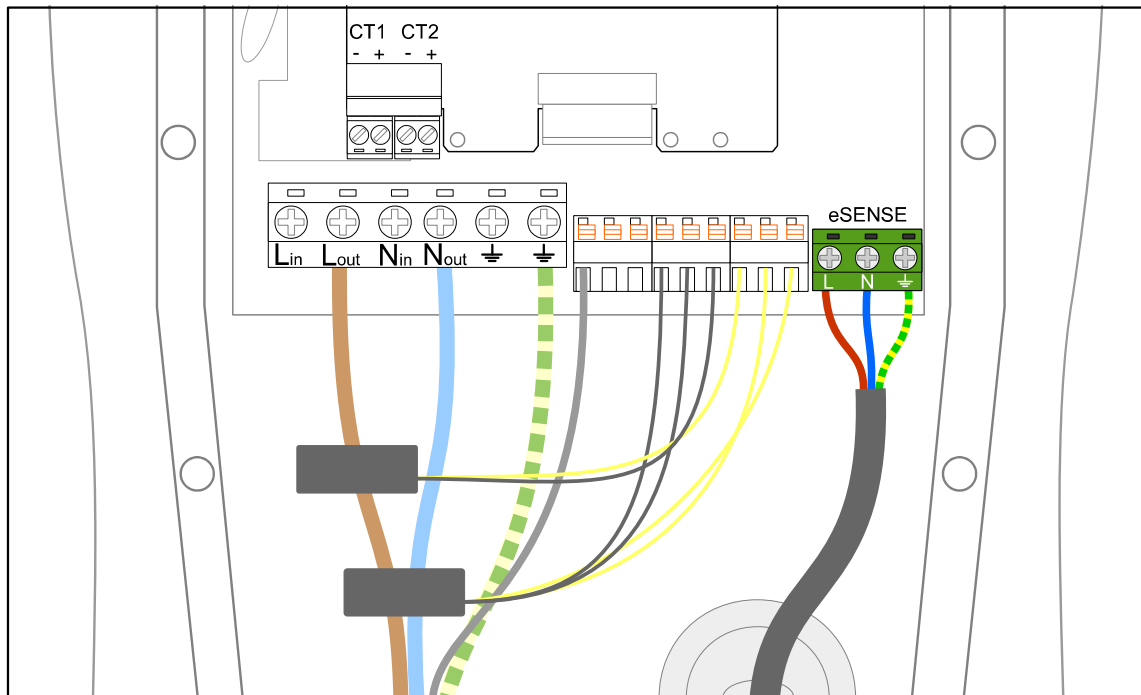

Fitting the Cover

1. Refit the cover and secure with ALL twelve of the M4 screws. It is best to screw these by going around in sequence shown without skipping any holes.
2. Slot the white cover down onto the unit and secure with the M3 screw at bottom.

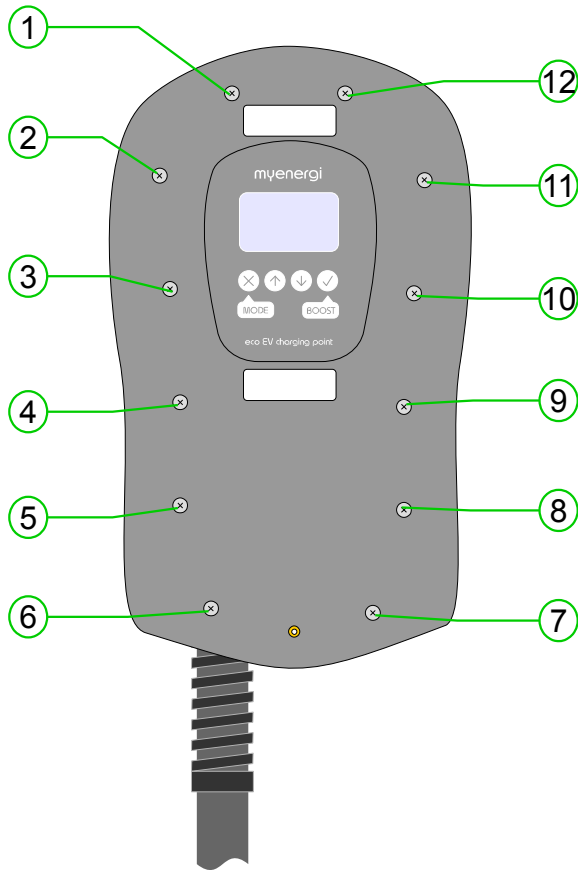

Setup

Switching On

After completing and checking the wiring of the supply, the sensor(s), switch on the **zappi** via the circuit breaker.

zappi will start-up and the main screen will be presented after a few seconds.

If **zappi** has been installed alongside another **zappi** unit or another **myenergi** device, refer to *Linking Devices* (page 20) for guidance on pairing devices. Also refer to the instruction documentation for the other devices.

Testing

Before leaving site, it is wise to perform a few checks to ensure that the sensors have been correctly installed and are functional.

1. Check that the time and date are correct and displayed at the bottom left of the main screen. If they are not present or are incorrect, set the correct time and date in the **Other Settings/Time & Date** menu option.
2. Check that the EV will charge in FAST mode.
3. Check the Grid Power reading at the top right of the main screen is showing sensible readings and the direction of power flow is as expected.
4. With the EV plugged in, switch to ECO mode charging and check that the charge power is at minimum (about **1.4kW**) OR that it is 'tracking' the surplus power (i.e. the Grid Power reading is **0.0kW**)
5. If a Generation Sensor has been installed, check that the generated power is shown at the top left of the main screen.



If the generation reading is missing, the most likely cause is the **CT2** input is not enabled – see *CT Inputs* on page 19. Or, if the Grid Sensor is instead wired to a **harvi** ensure the device settings are correct – see *Device Settings* on page 20.

Troubleshooting

Symptom	Cause	Solution
Display is blank	<ul style="list-style-type: none">- There is no power to the unit	<ul style="list-style-type: none">- Check for correct supply voltage at the supply screw terminals (220 - 260V AC)
In ECO+ mode, the charge does not start, the display is always showing Waiting for Surplus and the export power is 0W	<ul style="list-style-type: none">- Grid Sensor incorrectly installed- Faulty Grid Sensor- No signal from harvi (if used)	<ul style="list-style-type: none">- Check the grid sensor is connected to CT1 terminals of the zappi or harvi- Check the Grid Sensor is installed on the correct cable (see <i>Grid Sensor Installation</i> page 26)- Check resistance of the sensor - it should be around 200 Ω when not connected (remove the sensor from the cable before testing resistance)- If using harvi, check that the CT input has been set to Grid in the harvi settings (under Devices in the zappi menu)
In ECO+ mode, the charge does not start, the display is always showing Waiting for Surplus , yet the export power is showing correctly	<ul style="list-style-type: none">- Export Margin set too high	<ul style="list-style-type: none">- Check Export Margin setting (default is 0W)
Generation power is always 0.0kW	<ul style="list-style-type: none">- Generation sensor not installed	<ul style="list-style-type: none">- Install generation sensor and connect to CT2 input- Alternatively, the Generation and House consumption figures can be hidden on the main screen by setting CT2 Input in the Advanced Settings menu to OFF

Faults

If any of the following fault messages are displayed, follow the action described. However, if the problem persists, stop using zappi and call your installer or your local technical support.

Displayed Message	Description	Action
Ground Fault!	The internal Earth leakage protection has tripped	Unplug from the EV and press and hold the  button to reset the unit
Over Current!	The EV is drawing too much current – the output is switched off	Unplug from the EV and press and hold the  button to reset the unit
Overheating!	The zappi unit is too hot – the output is switched off	Unplug from the EV and press and hold the  button to reset the unit Allow the unit to cool down before attempting to charge again

Warranty

Subject to the provisions described below, this product is protected for three (3) years from the date of purchase against defects in material and workmanship.

Prior to returning any defective product to myenergi, the end customer must report the faulty product to **myenergi** by either emailing **myenergi** at support@myenergi.uk or calling **myenergi** on 01472 398182. If **myenergi** agrees that the product should be returned, it will issue a Return Merchandise Authorisation (RMA) number, the RMA must be clearly marked on the packaging of the product to be returned. **myenergi** may arrange collection at its discretion, otherwise the customer should return the product at their own cost.

Should the product fail to perform as described within the relevant warranted period as set out above, it will be repaired or replaced with the same or functionally equivalent product by **myenergi**, at its discretion, free of charge provided the end customer: (1) returns the failed product to **myenergi** with shipping charge prepaid, and (2) provides **myenergi** with proof of the original date of purchase. Returned or replacement products will be returned to the end customer with shipping charges prepaid.

Replacement products may be refurbished or contain refurbished materials. If **myenergi**, by its sole determination, is unable to repair or replace the defective product, it will refund the depreciated purchase price of the product.

The warranty does not apply if, in the judgement of **myenergi**, the product fails due to damage from shipment, handling, storage, incorrect installation, accident, inappropriate use or cleaning of the product, relocation of the product after its first installation, abuse, misuse, or if it has been used or maintained in a manner not conforming to product manual instructions, has been modified in any way, or has had any serial number or other identification markings removed or defaced.

Repair by anyone other than **myenergi** or an approved agent will void this warranty.

All defective products should be returned to **myenergi** with shipping charges prepaid, unless **myenergi** have arranged collection at its own cost.

Nothing in this agreement will affect the end customer's statutory rights or limit or exclude **myenergi's** liability for (1) death or personal injury caused by its negligence, or the negligence of its employees, agents or subcontractors (as applicable), (2) fraud or fraudulent misrepresentation; (3) defective products under the Consumer Protection Act 1987; or (4) any matter in respect of which it would be unlawful for **myenergi** to exclude or restrict liability.

The maximum liability of **myenergi** under this warranty is limited to the purchase price of the product covered by the warranty.

myenergi only supply products for resale for domestic and private use. **myenergi** accept no liability for any commercial, business or re-sale purpose by the end customer, and **myenergi** accept no liability to the end customer for any loss of profit, loss of business, business interruption, or loss of business opportunity.

Technical Specifications

Performance

Mounting Location	Indoor or Outdoor (permanent mounting)
Charging Mode	Mode 3 (IEC 61851-1 compliant communication protocol)
Display	Graphical backlit LCD
Charging Current	6A to 32A (variable)
Grid Import Power Limiting	2kW to 24kW (optional setting to limit power drawn from the grid)
Charging Profile	3 charging modes: ECO, ECO+ and FAST
Connector Type	Type 1 or Type 2 tethered cable, 5m or 8m
Compliance	LVD 2014/35/EU, EMC 2014/30/EU, EN 61851-1 & 22, EN 62196, CE Certified

Electrical Specifications

Rated Power	7kW
Rated Supply Voltage	230V AC Single Phase (+/- 10%)
Supply Frequency	50Hz
Rated Current	32A max
Standby Power Consumption	1W
Earth Leakage Protection	Integral 30mA RCD (Type A)
Thermal Protection	Output current thermally limited if unit temperature is > 85°C
Over-current Protection	>35A for 1 second
Economy Tariff Sense Input	230V AC sensing (2.5kV isolated)
Wireless Interface	868 MHz (proprietary protocol) for wireless sensor and remote monitoring options
Grid Current Sensor	100A max. primary current, 16mm max. cable diameter
Supply Cable Entry	Rear or bottom option

Mechanical Specifications

Enclosure Dimensions	362 x 220 x 78mm
Cord Length	5m or 8m
Protection Degree	IP65 (weatherproof)
Enclosure Material	ABS 6 & 3mm (UL 94 flame retardant) colours: white RAL 9016 and grey RAL 9006
Operating Temperature	-30°C to +50°C
Fixing Points	In-line vertical mounting holes

Model Variants

MODEL	Connector Type	Cable Length
ZAPPI-32A1P1T05	Type 1 (J1772)	5m
ZAPPI-32A1P1T08	Type 1 (J1772)	8m
ZAPPI-32A1P2T05	Type 2 (EN62196)	5m
ZAPPI-32A1P2T08	Type 2 (EN62196)	8m

Designed to permit installations compliant with IET Wiring Regulations BS7671:2008+A3 2015 and the Electricity Safety, Quality, and Continuity Regulations 2002 and BS 8300:2009+A1:2010.

myenergi.uk

Designed and manufactured in the UK by
MyEnergi Ltd, Church View Business Park, Binbrook, Market Rasen, LN8 6BY
+44 (0)1472 398182