

# **LITESLATE**

## FIXING GUIDE

**BRITMET**  
L I G H T W E I G H T R O O F I N G

Kingfisher House, Unit 17 Overthorpe Road, Banbury, Oxon, OX16 4SX  
Tel: 01295 250998, Email: [sales@britmet.co.uk](mailto:sales@britmet.co.uk) , [www.britmet.co.uk](http://www.britmet.co.uk)

## – Product Information –

### **No Special Tools Required**

- Hand fastened (hammered) or fastened with a pneumatic nail gun.
- Sharp utility blade or a standard circular saw.
- Tape measure, pry bar, tin snips.
- Chalk line with blue chalk (do not use red chalk).

### **Storing the Product**

For proper installation, the slates need to be stored on the original pallet on a flat surface. Proper storage of the product at the job site is important. The slates are cambered to ensure that maximum pressure is transferred to the leading edge of the slate during installation. **Do not double stack pallets.**

**Conditions:** Perform work when existing and forecasted weather permits. Work should be performed in a safe and professional manner and when ambient weather conditions are within the limits established by Britmet Tileform Ltd.

**Storage:** LiteSlate should not be stored on roof decks in such a manner as to over-stress and/or damage the deck and supporting structure.

**Cold Weather Installation:** LiteSlate should be stored in original packaging in a storage facility where the temperature meets or exceeds 6°C. Use protective coverage over all pallets while being temporarily stored on-site. LiteSlate must be conditioned at a temperature no lower than 6°C for twenty-four (24) hours prior to use. LiteSlate may be installed at temperatures as low as 0°C but must be hand fastened, the use of a pneumatic gun below 6°C will result in cracking and webbing in the fastened area. Be sure to follow the manufacturer's installation requirements for all underlay or membrane and any other applications. Comply with any and all local building regulations. Note of Caution: The slates can be slippery under certain conditions and job site safety procedures should be enforced.

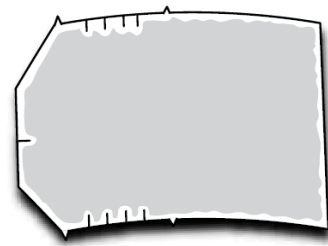

### **Product Description**

LiteSlate are manufactured from a recyclable blend of limestone and polypropylene, and are made from multiple natural patterns. The slate measures 442mm in height and 300mm in width. The ridge cap measures 155mm by 442mm.

- Warranty – 40-year.
- Weight (slate) – Nominal 570g.
- Weight (ridge cap) – Nominal 580g.
- Ridge – 5.5 per linear metre.
- Hip – 5.5 to 6.5 per linear metre (depending on gauge)
- Packaging – Pallet: 1600 slates (1000kg), Bundle: 22 slates (12.6kg).
- Batten Size – 50mm x 25mm treated battens (minimum).
- Thickness of roofing board – 18mm OSB.
- Fixing – Large-headed galvanised 30mm x 2.5mm steel nails (using hammer or nail-gun). Aluminium or copper nails may also be used, but driving them through the slate may cause bending. Longer 76mm nail required for fixing ridges and hips.
- Cutting – Fine-toothed handsaw, jigsaw, circular saw, or sharp utility blade.
- Minimum pitch – 14° (Board & Batten)
- Maximum pitch – 90°.
- No sorting required.

LiteSlate Markings

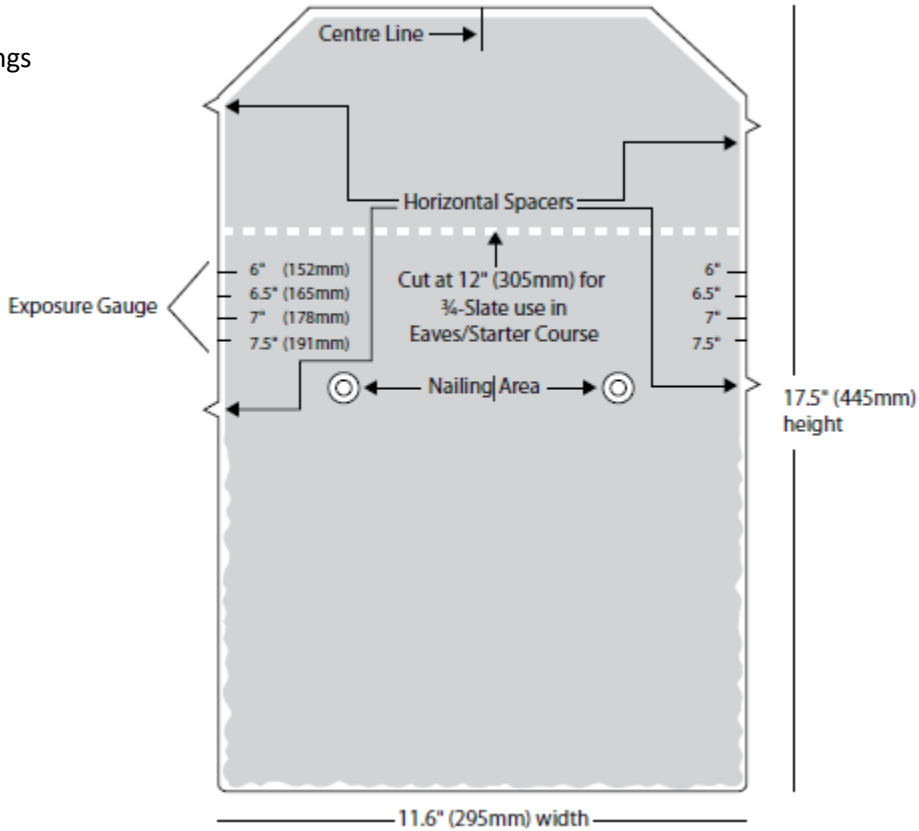

**Pitch, Gauge, and Coverage**

**Roof Pitch**

<u>Roof Pitch</u>	<u>Gauge</u>	<u>Slates per m<sup>2</sup></u>
14 to 25 degrees (fully boarded or felt & battens)	152mm	22
25 to 27.5 degrees (fully boarded or felt & battens)	165mm	20
27.5 to 30 degrees (fully boarded or felt & battens)	178mm	19
above 30 degrees (fully boarded or felt & battens)	190mm	18

Please contact our technical department for advice when installing in high exposure area's

**Hip and Ridge Dimensions**

- Length: .....442mm
- Height: .....155mm
- Exposure: ..... 152mm to 191mm
- Pre-formed Pitch: .....Universal

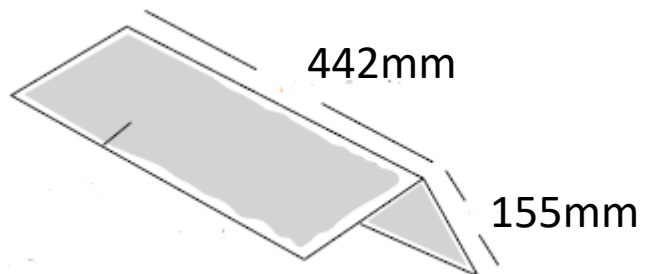

## **Recycling**

LiteSlate is 100% recyclable.

## **Fastener Recommendations**

Slates should be applied using two (2) galvanised/stainless steel or copper fasteners with a minimum 10mm diameter head and minimum length of 30mm. Corrosion resistant fasteners are always recommended, especially in coastal areas.

The length of the Hip & Ridge fastener should be a minimum length of 50mm over the slates and 76mm over ridge vent.

**Note:** Caution should always be used to ensure against over/under penetration of the fastener. **Do not over-drive the fastener.** The fastener head should be contacting the slate within the centre of the nailing target circle.

All slates will be attached with two fasteners, as per these instructions.

Improper fastening can compromise the roof system and voids the manufacturers' warranty.

## **Roof Decking Materials**

- Minimum of 18mm plywood decking, solid wood decking, or oriented strand board (OSB).

### Roof Venting:

**Ridge:** Felt underlay / Boarding to be cut back, allowing a 12.5mm air gap on either side of the centre line of the ridge. If necessary cut the top course of LiteSlate to suit roof dimension to allow for 12.5mm air gap.

Fix LiteSlate ridge ventilator on top of the top course of Slate and overlay LiteSlate ridge and fix in accordance to manufactures instructions.

**Eave:** Fix LiteSlate eave vents, 10mm or 25mm on top of fascia board, 10mm vent for 15° roof pitch and 25mm vent for roof pitches less than 15°. Eave vent to be in line with top of battens, fit lay board or tilting fillet at eave if appropriate, to ensure any moisture on under drains into gutter.

## – Installation Guidelines –

### Spacing Between the Slates

5mm spacer tabs are provided on every slate to aid in maintaining consistent spacing. The spacers will allow for any movement of the roof deck and expansion/contraction of the slate.

### Laying Out ½ Slates or Cut Slates

When beginning or finishing with a cut piece of slate, the cut edge should be installed inward. The manufactured edge should be installed to the outside edge of the roof. This is to maintain an acceptable roof appearance along the gable edge of the roof.

The centre mark of the slate can be used as a guide to cut ½-slates. This can also be used as a guide to keep courses straight and to assist in maintaining the proper 5mm spacing when aligning with intermittent vertical chalk lines.

**DO NOT install slates smaller than 100mm**

### Preparation

Inspect all areas of the roof surface to be covered.

1. The surface area must be uniformly flat, smooth, sound, clean and free of irregularities.
2. Examine roof boarding to verify that boarding joints are correct.
3. Verify that substrate is sloped for drainage and completely anchored to sound framing. Any foreign particles shall be cleaned from interlocking areas to ensure proper seating and to prevent moisture intrusion and cold bridging. Proper provisions must be made for flashings and roof penetrations.
4. Product handling and storage on a flat surface is very important. LiteSlate has a cambered design to ensure that the maximum pressure is transferred to the leading edge of the roof slate during the installation process. Do not double stack pallets.

### Hip Roof Layout

1. Initial starting points may be from left side, right side or centre of the area to be installed. 5mm spacer tabs are provided on every roof slate.
2. A full slate can be cut into ¾ size to create an eaves or starter slate for the starter course.

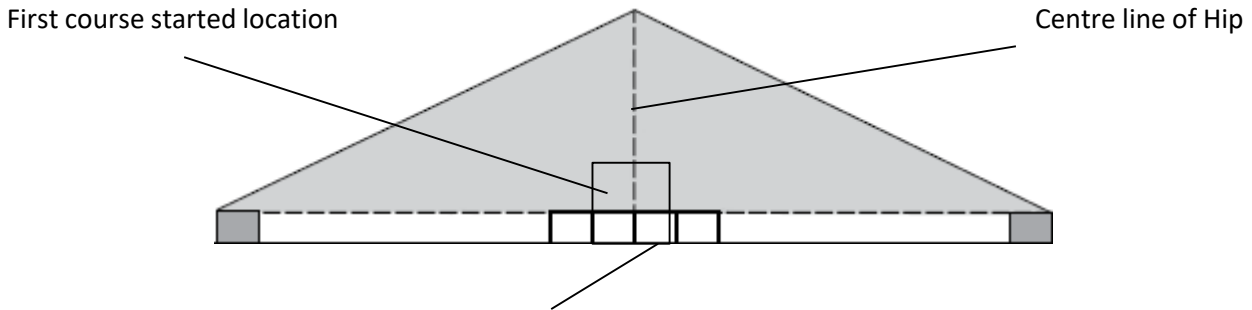

Start  $\frac{3}{4}$  Slate from left/right of the centre line of the hip, ensure 50mm (max) into gutter and spacing to suit 5mm taps. Using the full Slate, begin the first full course, align centre of Slate directly over  $\frac{3}{4}$  Slate to form a broken bond lap.

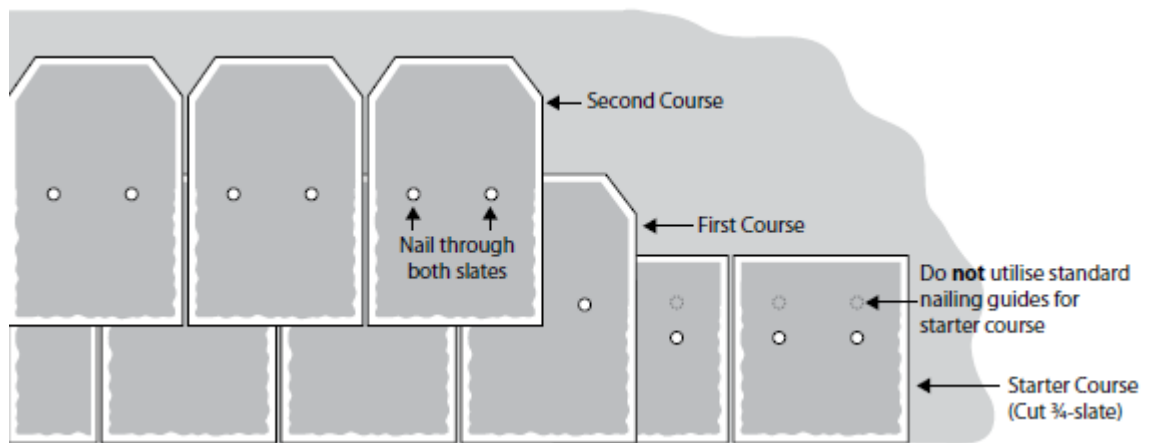

After installing the underlay or membrane and before installing the LiteSlate, clean the surface of debris and dirt. Foreign particles shall be cleaned and removed from interlocking areas to ensure proper seating of the product and to prevent moisture intrusion and cold bridging. All roof penetrations shall be properly flashed and secured into position with deck and underlay or membrane fasteners properly driven and not protruding prior to installing LiteSlate roofing products.

- a) Full slates can be cut into  $\frac{3}{4}$ , approximately 305mm, to be used on the starter course, and at the ridge if necessary.
- b) These eaves or starter slates will be used as the first row at the eave of the roof.
- c) To create the broken bond from course-to-course, use the centre mark provided on each slate and cut the slate lengthwise. This ensures that the nail holes are covered with the next course of slates and no through-joints are exposed to the deck.
- d) Strike the chalk lines horizontally, at the exposure level desired, to ensure that the slates are installed straight and uniform. Vertical chalk lines will help maintain consistency in the key-ways.
- e) Spacer tabs are provided on each slate to ensure consistent spacing between slates.
- f) There shall be no through-joints from the roof surface to the underlay or membrane.

Each slate shall be fastened with a minimum of two galvanised roofing fasteners. The fasteners must be a minimum of 30mm long and 3mm in diameter with a 10mm diameter head.

g) It is required that the fasteners be placed within the two nailing targets on each slate. Flatten slate then fasten. Fastener must penetrate at least 18mm.

h) Caution should be taken where the underside of the roof board is exposed to view, such as in an overhanging eave, where the nails should be long enough to penetrate the roof boarding but not so long that they may be driven through the boarding.

Continue the second course with a full standard slate set back from the course below, the finished edge facing the gable edge. Align the full roof slate between the centreline locators from the lower course. Next, adjust the roof slate up or down to align the desired exposure lines with the top edge of the lower course. (See diagram at right, and roof pitch table information on page 4 for which exposure line to use.)

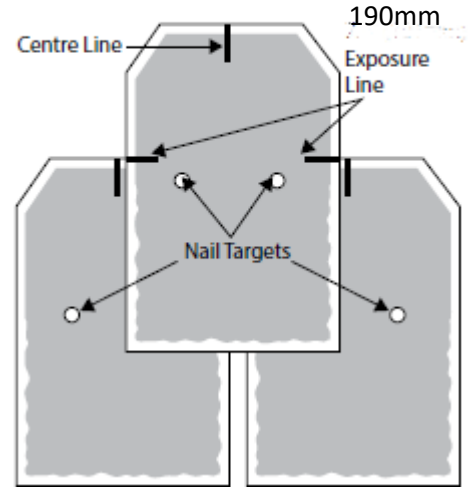

**Felt and Batten Roof**

The first course and eaves (starter) course should oversail the fascia by at least 38mm, so the first course batten should be placed approximately 190mm centrally from the start of the roof (see diagram). A second batten should then be placed directly under the first course batten to accommodate the eaves or starter course (made from a cut ¾-slate).

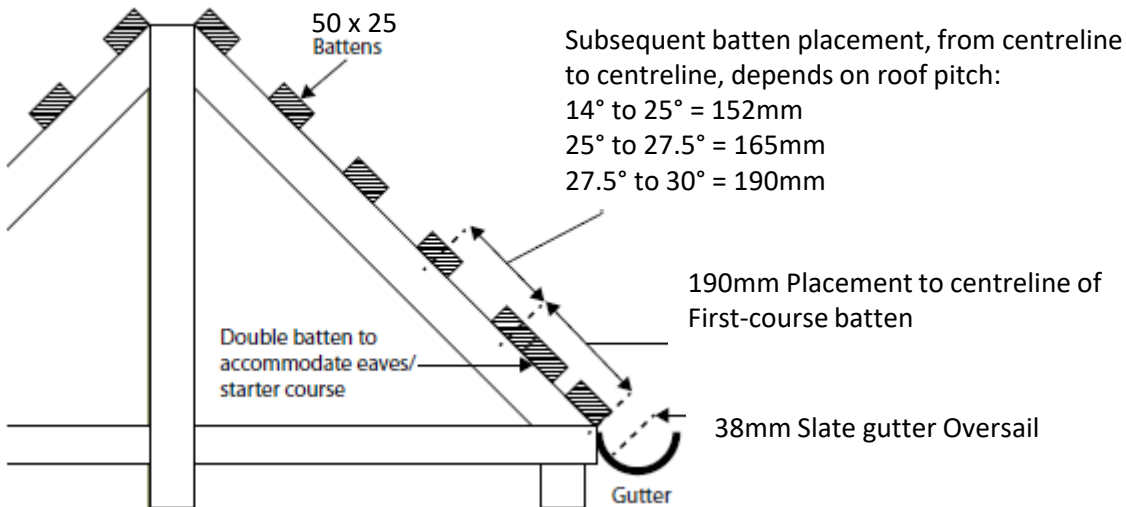

The distance from the first course batten to the second course batten, and beyond, is dependent on the roof pitch and subsequent exposure gauge settings. Please see the diagram of the LiteSlate, and the Pitch, Gauge, and Coverage table on page 4. The diagram above also shows an approximate guide to subsequent batten placement.

The position of the top battens should then be established to ensure that the top course of slates will be covered by the ridge cap. Fix eaves, or starter course using a ¾-cut slate which can be easily cut to size from a full slate using a fine-toothed hand/circular saw or a sharp utility blade. As stated earlier, the first course and eaves (starter) course should oversail the fascia by at least 38mm. This ensures water disperses into the centre of the gutter. This must be taken into account when calculating the gauge and positioning the battens.

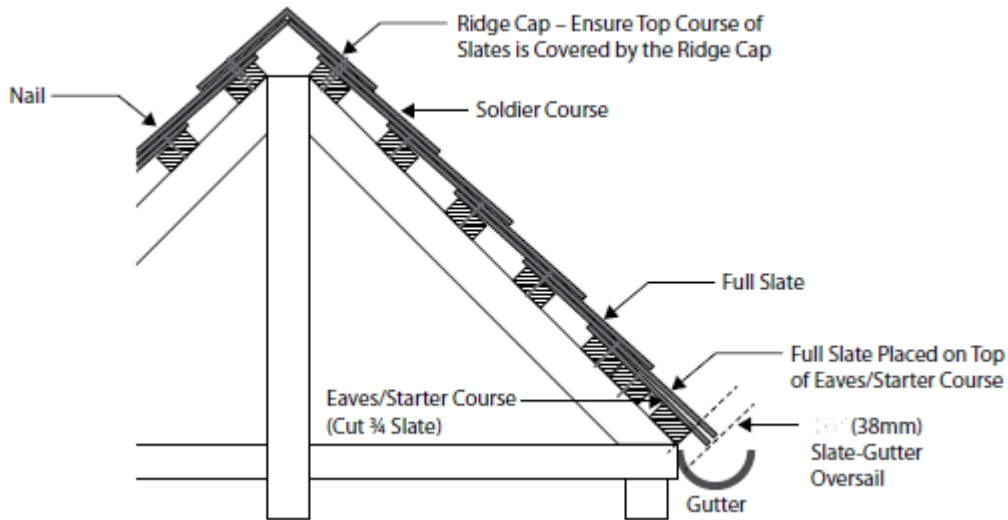

The required gauge and number of courses can then be calculated. The first course should sit on top of an eaves course. Double batten as shown in the diagram to accommodate the eaves slates.

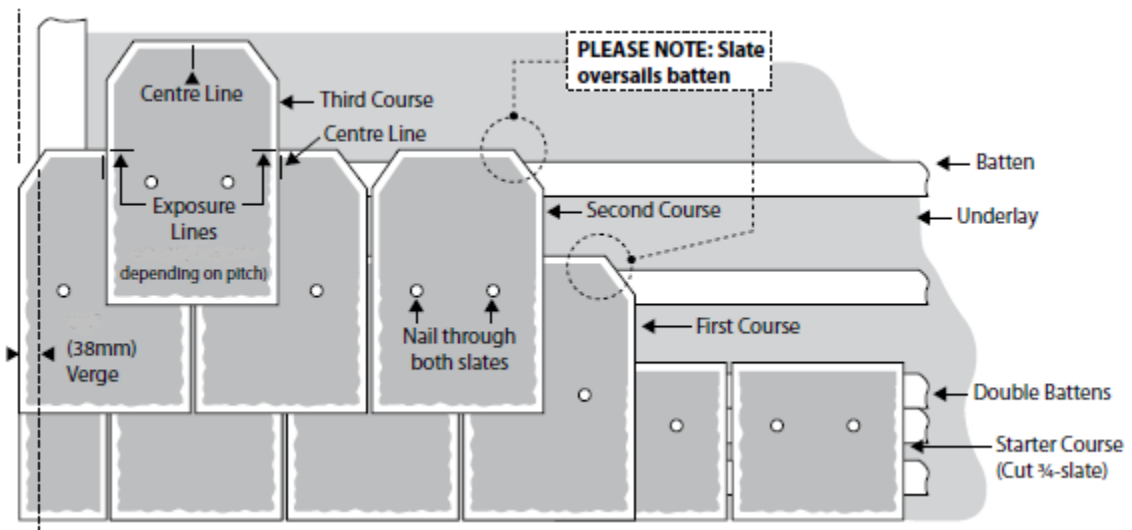

Verge slates should oversail the brickwork/barge board by 38mm, and may need to be cut to size at either end.



Lay the first course of full slates over the eaves course and fix to the second batten. Ensure that the first course and eaves course are laid "broken bond" so that the joints do not line up and the weatherproofing integrity is maintained.

Lay subsequent courses "broken bond" as illustrated. It will be necessary to cut to start and finish every other course.

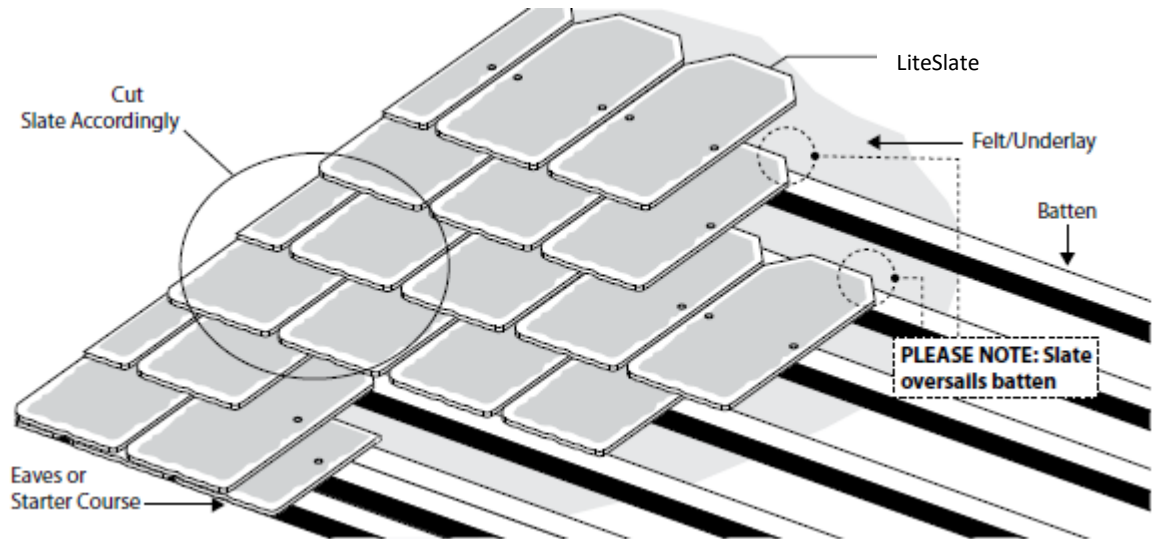

### Ridge Cap Finishing

Easy Ridge Caps should be finished by cutting a standard LiteSlate at the end of the ridge into a triangle or diamond shape of the right size to cover the end gap. The resulting material should then be nailed in place into the end-battens and/or truss. The material can be sealed by using a good quality silicon sealant. Alternatively, the material can be joined to the Ridge Cap by using a strong epoxy glue (adhering to the manufacturers instructions). Nail heads should be disguised with coloured sealant/paint.

### Standard Ridge Cap End Piece

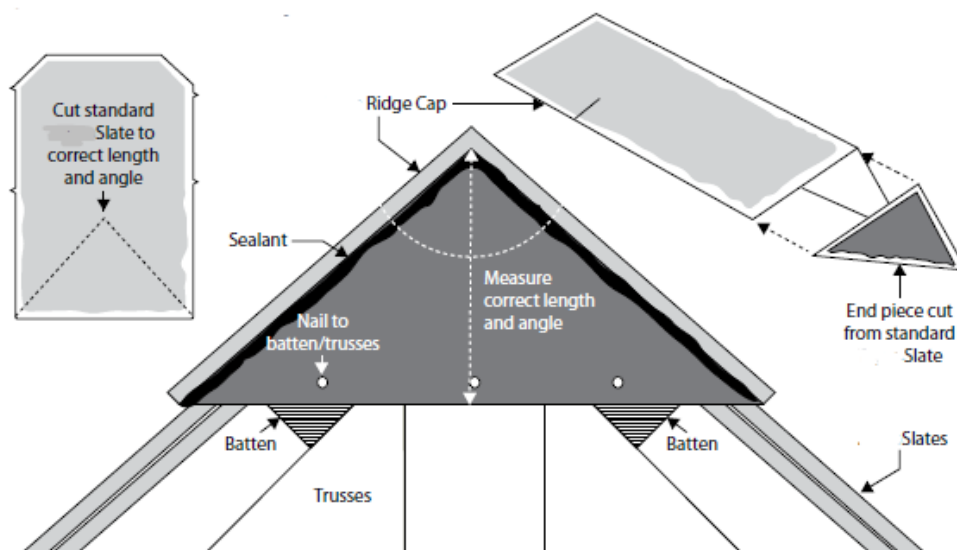

The same principle for finishing Easy Ridge Caps can be applied to an angular finish roof by measuring the roof angle and cutting a Easy Ridge Cap to suit. A similar measurement can be applied to a standard LiteSlate to cut the right size and angle to cover the end hole in the Ridge Cap. Note that with an angular finish the material may have to be joined by using a strong epoxy glue (adhering to the manufacturer's instructions), unless there is enough batten/truss material to nail to.

### Angled Ridge Cap End Piece

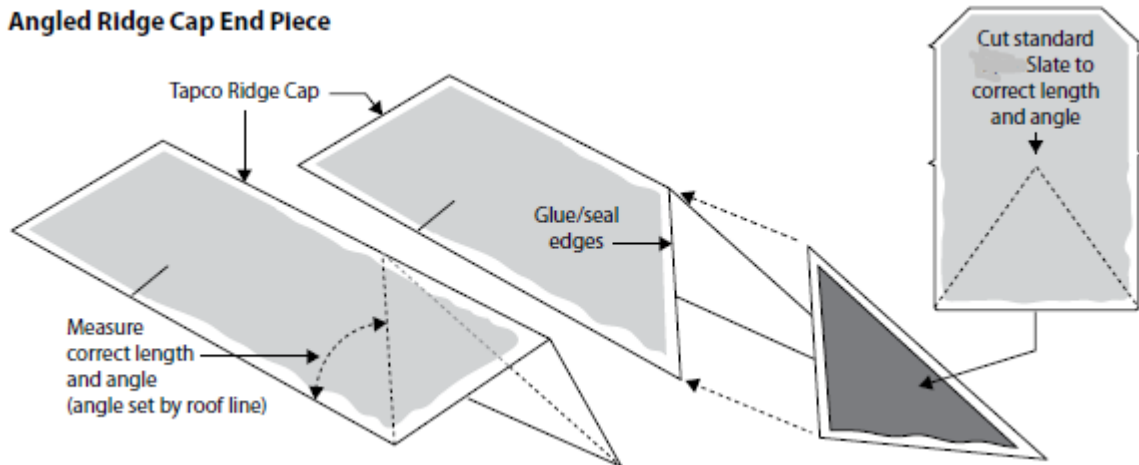

## Valley

### Open Valley Design

1. Install valley board 12mm fixed into 50 x 50mm support batten in-between rafters.
2. Fasten a layer of Breather membrane along the full length of valley board.
3. Lay GRP valley as per manufacture instructions.
4. Lay Breather membrane as per the normal manner.
5. Fix LiteSlate, cut to suit.

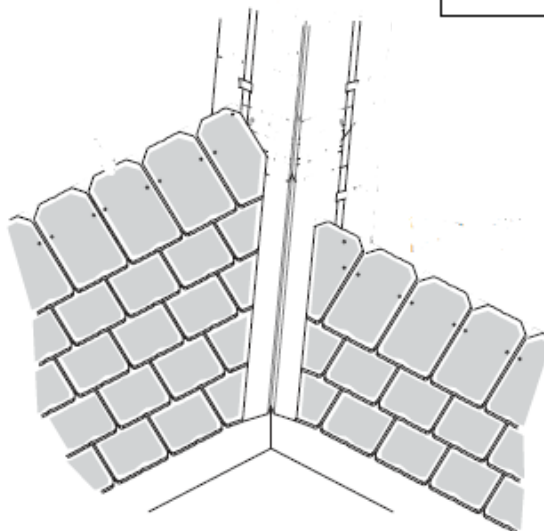
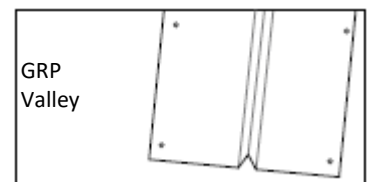

**Step Flashings**

Step flashings are used over or under the roof coverings and are turned up on the vertical surface. Step flashings should extend under the uppermost row of the roof slate the full depth of the roof slate or at least 102mm over the roof slate immediately below the metal. The vertical leg of the metal should be turned up a minimum of 102mm and extend 102mm on the roof slate with a 19mm hem. Flashings should have a minimum length of 229mm and must overlap a minimum of 51mm.

**Step Flashing**

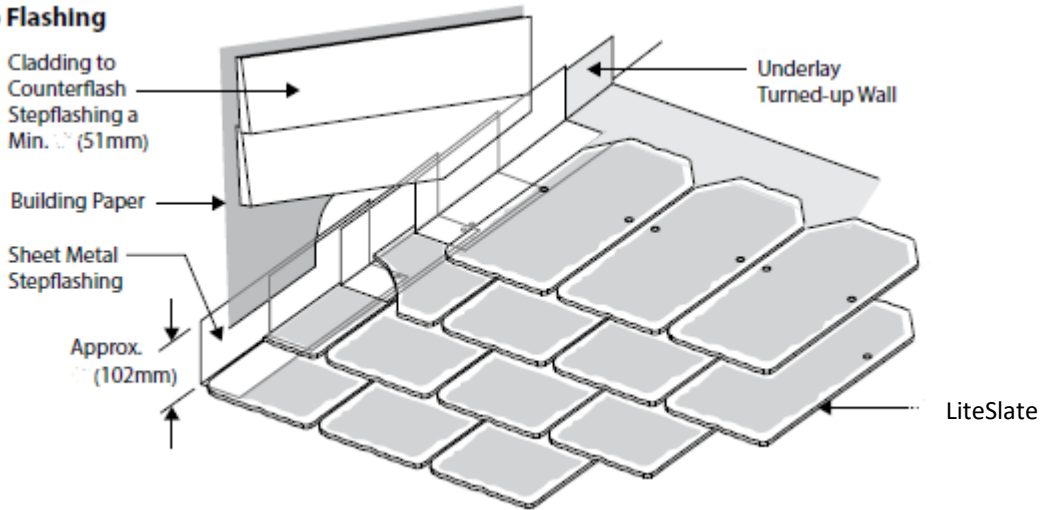

**Apron (Roof to Wall) Flashing**

Lead apron flashing is used when a roof terminates to a wall causing a course to be cut and face nailed. It is installed over the slates and behind siding or counter/cap flashing or dressed into brickwork/stonework, etc.

**Apron Flashing**

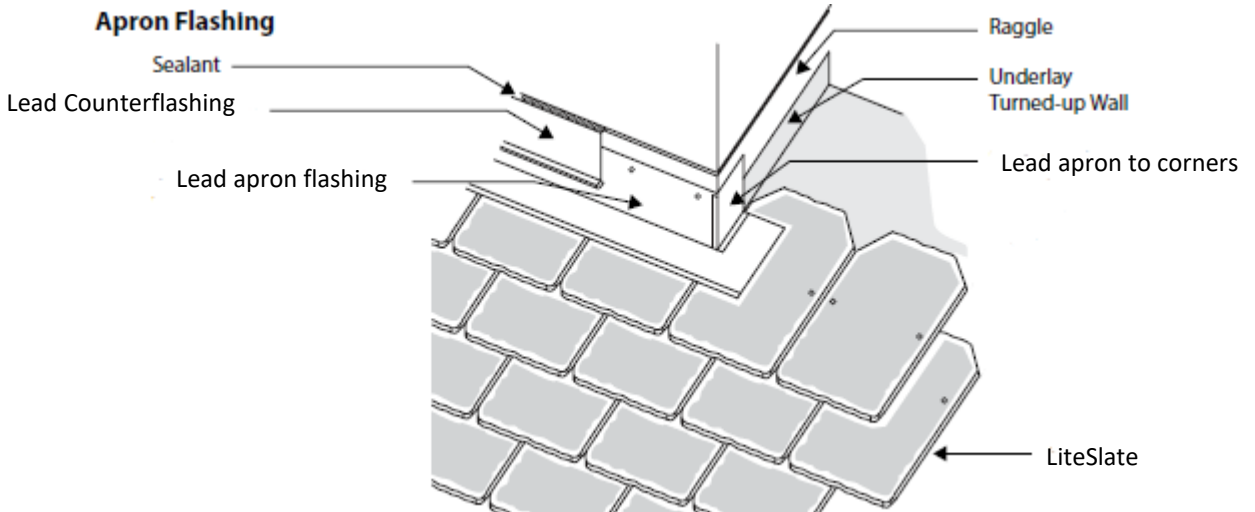

### Counter Flashing

1. Cut a minimum 25mm deep recess into the masonry material.
2. Custom bend the counter flashing to fit into the recess.
3. Start by installing lowest piece first and work upwards for proper water runoff.
4. Fasten the counter using lead anchors.

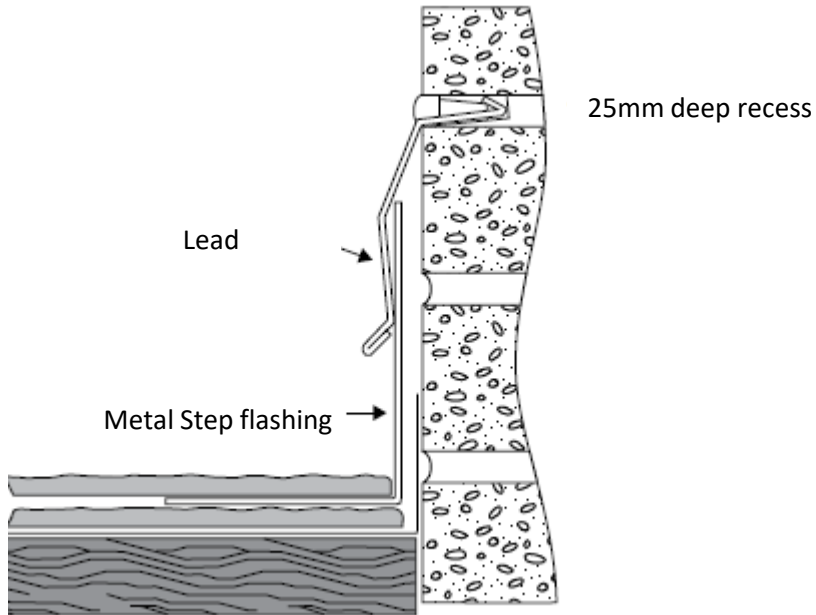

### Vent Flashings

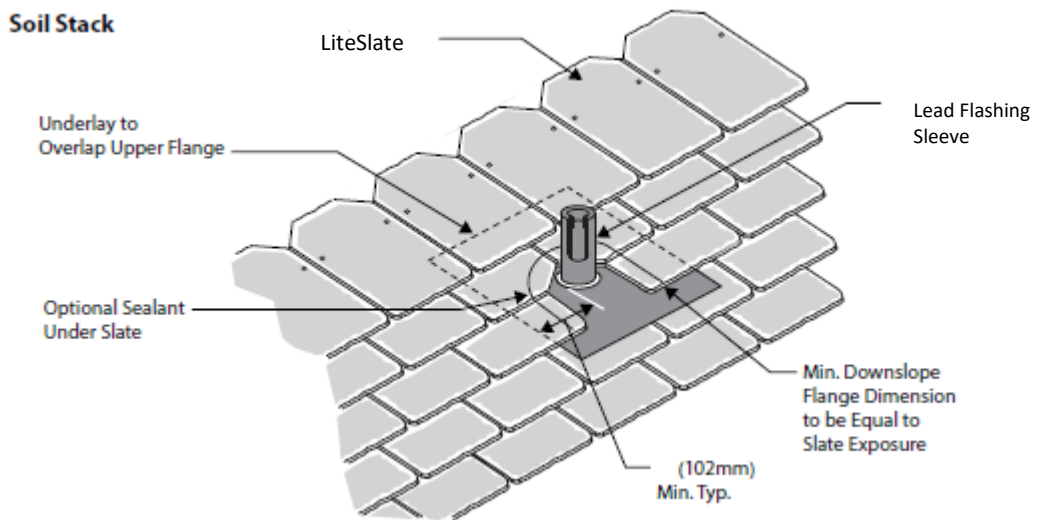

## Pitch changes

LiteSlate can be installed onto roofs with two pitches, using a lead flashing.

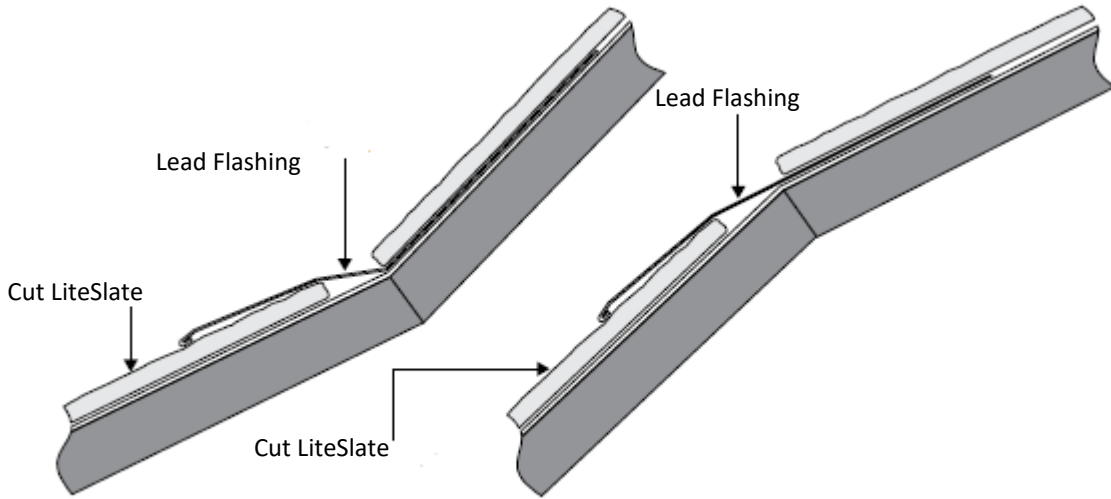

## Hip & Ridge Detail on a Boarded Roof

When pre-formed hip & ridge slates are used, place nail at fastener guide targets. Fasten hip slates with 2 nails (one on each side). Maintain a (152mm) exposure.

1. Hip & Ridge Slate installation requires the slate to be nailed or screwed in place.

a) Chalk a straight line by placing one piece of hip at the eave and one near the peak, hold the chalk line at the edge of the slate on the top and bottom pieces.

b) Cover heads of fasteners with an adhesive sealant compatible with the roof slate in any case of exposure.

c) Preformed Ridge Slates require 152mm exposure and require 50mm length fasteners 76mm when using easy vent ridge).

d) Fastener deck penetration must be a minimum of 19mm.

e) Ridge end closure can be effected by cutting a triangular section from a slate and nailing to the ridge batten, or in the case of a boarded roof, to a timber fillet.

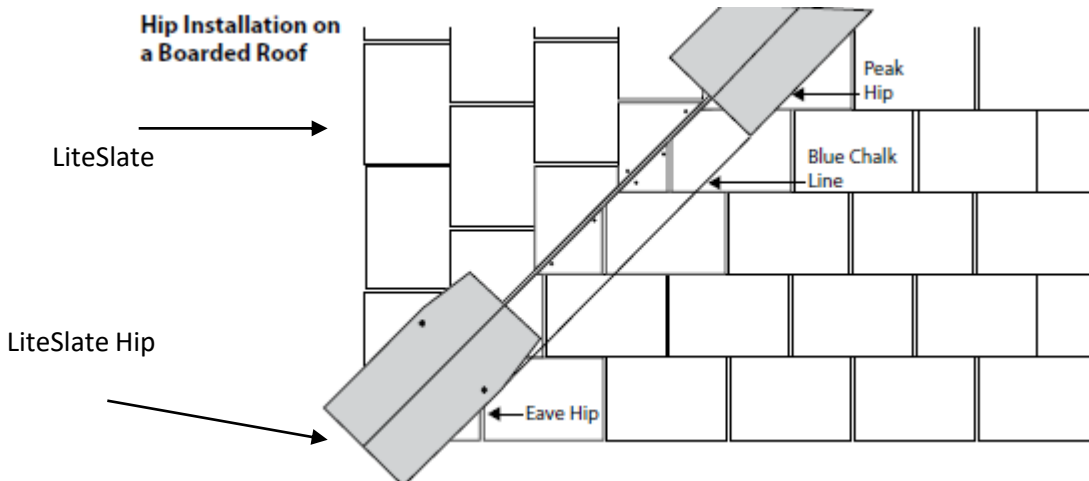

**Hip & Ridge Detail on a Felt & Batten Roof**

Felt & batten roofs need the addition of extra tiling battens to secure the hip tiles.

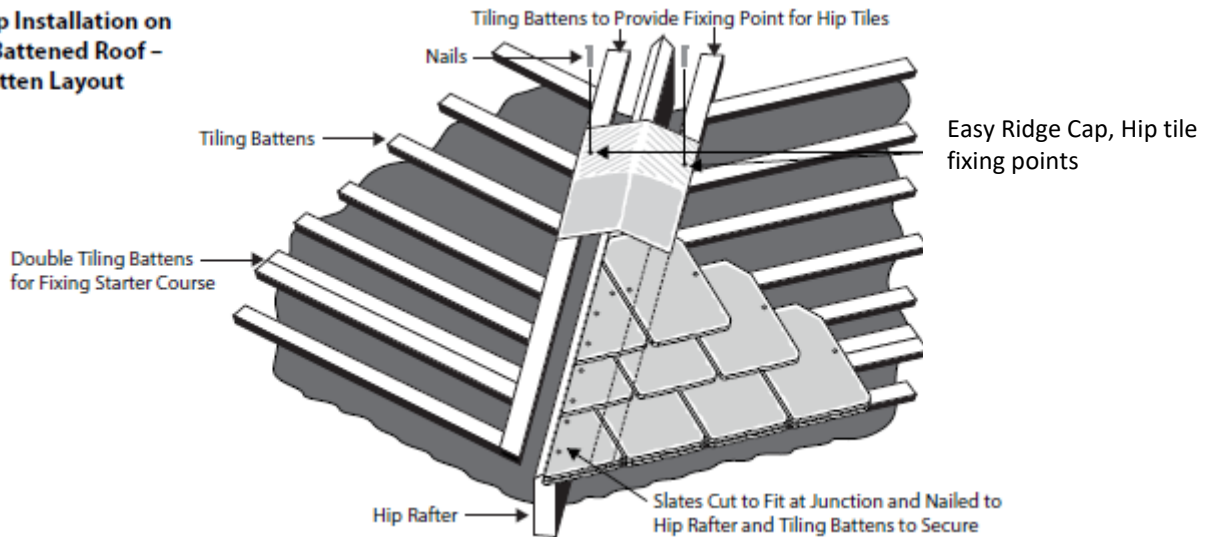
**Hip Installation on a Battened Roof – Batten Layout**

1. Cover the length of the hip with 600mm underlay from eave to ridge, overlapping the standard underlay on either side of the hip.
2. Position a hip tile in situ and mark the nailing points at the top and bottom of the hip.
3. Using these marks, secure a length of tiling batten either side of the hip to provide a fixing point for the hip tiles.
4. The slating battens should be fitted flush to these hip battens.
5. Cut slates to fit at junction.
6. Affix hip tiles using a minimum of 50mm nails or screws.
7. Finish at the eaves with a cut hip tile. Fill end with a shaped piece of standard LiteSlate.

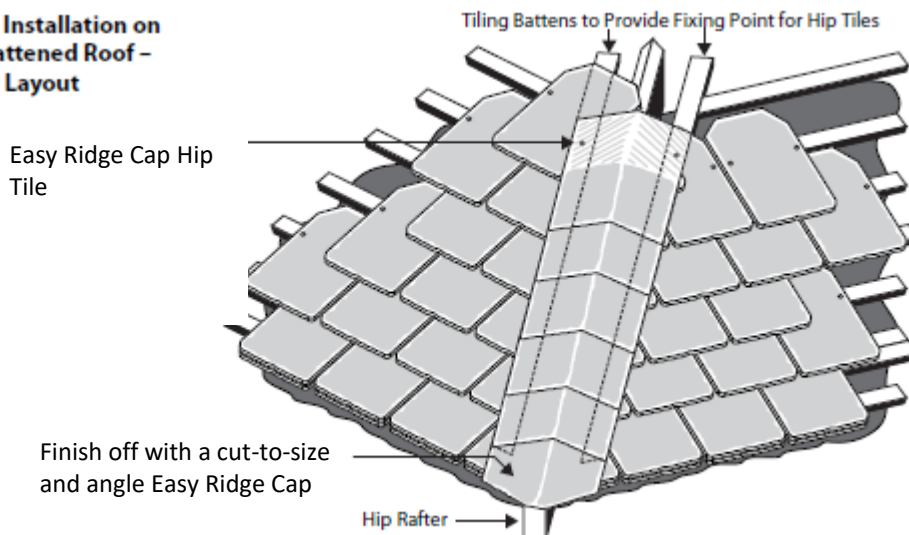
**Hip Installation on a Battened Roof – Tile Layout**

**Ridge-to-Hip Intersection**

When a ridge tile meets hip tiles, it is necessary to weatherproof this intersection. A lead saddle should be fitted to cover the intersection between the ridge tile and the mitred hip tiles. LiteSlate hip tiles cut easily without splintering or cracking to effect a tidy mitred joint.

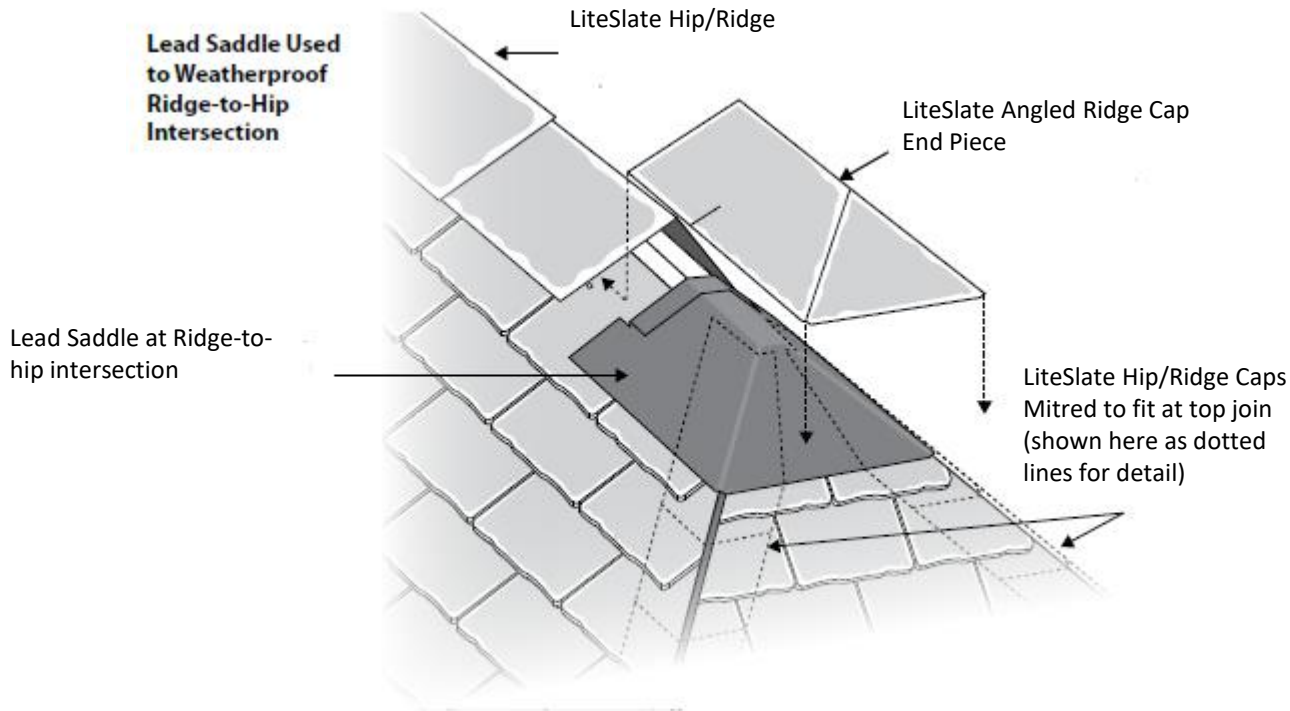



## – Special Instructions –

### Installation onto a Fully Boarded Roof on Pitches of 14° up to 22.5°

From time to time, certain roofing applications require installation of the slates at a lower roof pitch, (transition roofs, porch roofs, etc.), utilising a fully boarded roof, thus requiring changes to the moisture intrusion protection as it relates to the underlay and slate exposure. For fully boarded roof decks having slopes of 14 degrees up to 22.5 degrees, a proprietary breather membrane which conforms to DIN EN 20811 Water Column should be used. Slate exposure must be at 152mm in order for the Easy warranty to remain in effect. The Deck should be a minimum 18mm OSB. Easy recommendations do not supersede local building regulation requirements, which should always be followed.

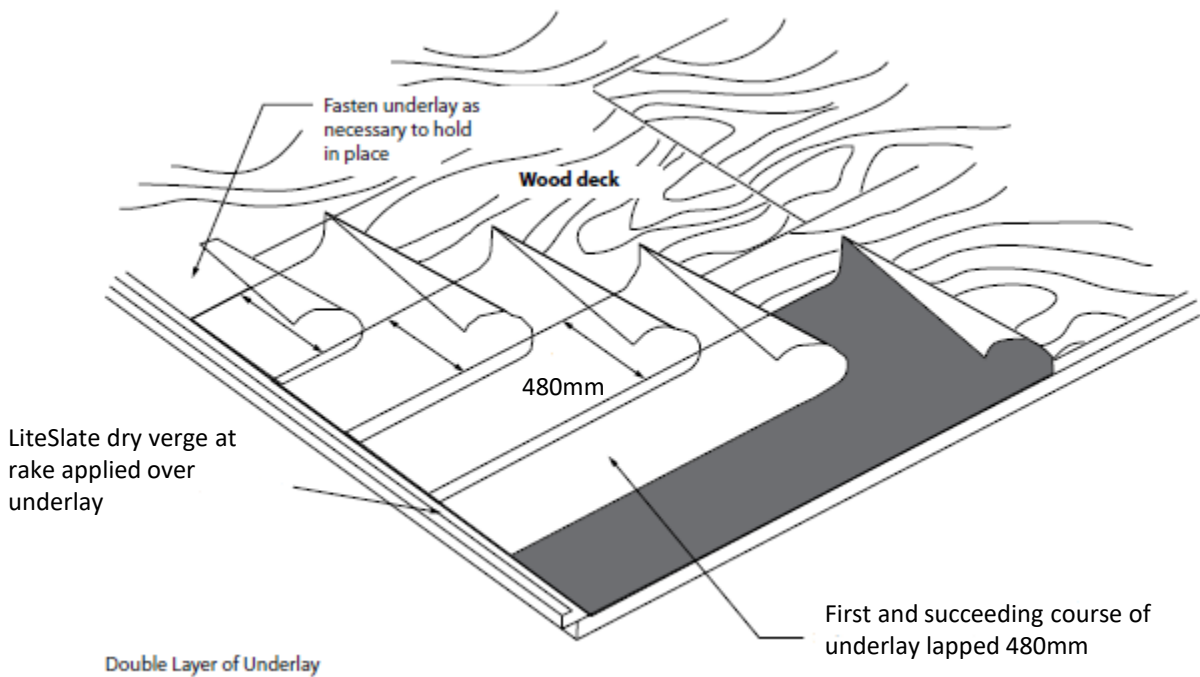



### Installation in Exceptionally High Wind Areas

There are certain areas, particularly on west-facing coasts and exposed islands, where wind speeds can exceed this level, and in order to reduce the risk of uplift, the following installation instructions should be followed:

1. LiteSlates should be fixed directly to a solid substrate, such as sarking board, OSB or weather-grade ply.
2. The maximum overlap – slates set at the 152mm gauge – should be used.
3. Standard copper roofing rivets should be installed: a hole is drilled in the overlapping or top slate, and a rivet is slid up between the gap in the two bottom slates (see diagram below). The rivet should be put in a position where it can be inserted through the hole and bent over. After a length of time the rivets will naturally blend in with the slate.

