

February 2015

Uniclass

L522:P4

CI/SfB (47) Nh2



Technical Drawings & Installers Guides

For Panel and Eave to Ridge Tile Systems

Lightweight Steel Roofing

BTL **BRITMET TILEFORM LIMITED**

INSTALLERS GUIDE FOR PANELS

1 REQUIREMENTS

PANELS

PROFILE 49

VILLATILE

SLATE 2000

ULTRALITE

PLAIN TILE

SOFT SOLED SAFETY SHOES

RULER

Pencil

TIN SNIPS

ROUND HEADED CLAW HAMMER

COLOUR NAILS

Bender

Guillotine

PLEASE NOTE: A UNDERLAY MUST BE USED

2 ADDITIONAL ACCESSORIES AVAILABLE

VENTED TOP ROW

ANGLE RIDGE/HIP FLASHING

B - RIDGE FLASHING

MONO RIDGE FLASHING

BARGE BOARD FLASHING

EAVES APRON FLASHING

SIDE WALL FLASHING

FLAT SHEET

COVER FLASHING

RIDGE VENT

VENTED TILE / SLATE

GRP VALLEY FLASHING

RIDGE BARREL & END CAP

3 FIXING THE FIRST BATTEN

TO SUIT THE ROOF PITCH AND THE TYPE OF GUTTER AND PRODUCT

MAX 328mm

ALLOW APPROX. 40mm INTO GUTTER

FIT FASCIA TO HEIGHT OF BATTENS, UNLESS EAVES VENTILATION IS BEING FITTED

NOTE: FOR VENTILATED EAVES, SEE PAGE 9

4 FIXING BATTENS FROM THE BOTTOM OF RAFTER, UP

BATTEN GAUGE:	0.45MM THICKNESS	OR	0.9MM THICKNESS
SLATE 2000:	369mm		367mm
PROFILE 49:	365mm		363mm
ULTRALITE:	370mm		368mm
PLAIN TILE:	160mm		158mm
VILLATILE:	365mm		363mm

LOWER FACE TO LOWER FACE

5

**NAIL TIMBER BARGE
BATTEN TO THE TOP OF
THE HORIZONTAL
BATTEN**

BARGE
BATTEN
SIZE 25mm - 38mm



6

**LAY THE PANELS
STARTING FROM THE
FIRST BATTEN BELOW
THE RIDGE**

FOR BEST APPEARANCE, LAY LAPS AWAY FROM
PRINCIPAL LINE OF SIGHT

TILES CAN BE LAID FROM LEFT TO RIGHT OR
RIGHT TO LEFT

SLATE 2000: PANELS MUST BE LAID FROM RIGHT TO LEFT

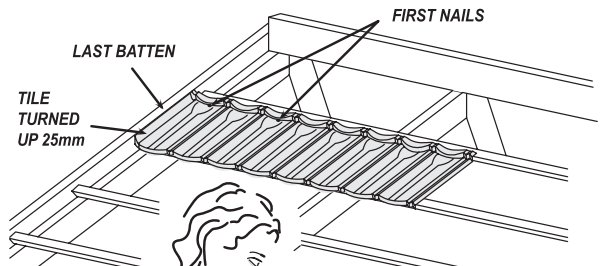

TILE
TURNED
UP 25mm

LAST BATTEN

FIRST NAILS

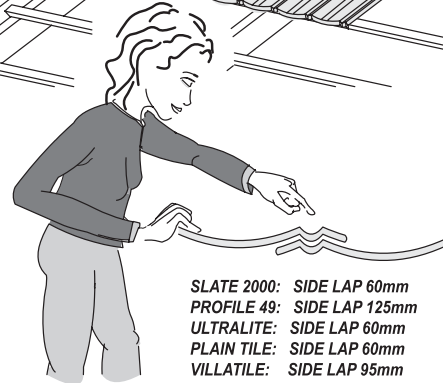

SLATE 2000: SIDE LAP 60mm
PROFILE 49: SIDE LAP 125mm
ULTRALITE: SIDE LAP 60mm
PLAIN TILE: SIDE LAP 60mm
VILLATILE: SIDE LAP 95mm

7

**WHEN WALKING ON THE
ROOF, PLACE FEET IN
THE PANS OF THE
PANELS WHERE THE
BATTENS ARE SITUATED.**

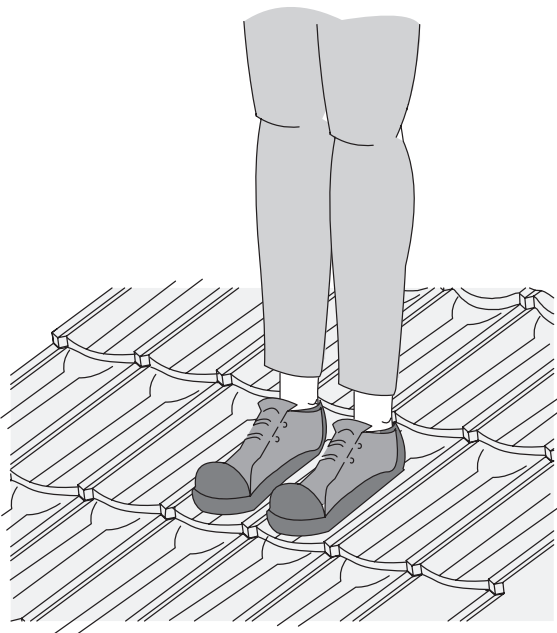

8

**ONCE YOU HAVE LAID
SEVERAL COURSES**

(LAYING THEM ONE UNDER THE OTHER...)

START NAILING THEM INTO PLACE - 4 PER TILE



NAIL PANELS THROUGH NOSE
REMEMBER: LEAVE BOTTOM COURSE LOOSE
UNTIL MORE PANELS HAVE BEEN LAID
Note: For 0.9mm Panels Tek Screws Can Be Used

9

NAIL THE EAVES COURSE THROUGH HIGH POINT OF PAN - 4 PER TILE

EITHER INTO THE TOP OF THE EAVES BATTEN OR FASCIA BOARD



AFTER COMPLETION OF THE ROOF, COVER THESE NAIL HEADS WITH THE TOUCH UP KIT.

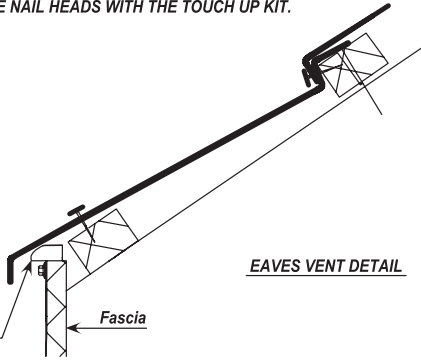

EAVES VENT DETAIL

Over Fascia Vent
10mm or 25mm

Fascia

ENSURE VENT IS AT THE SAME HEIGHT AS THE BATTEN (i.e. adjust height of fascia accordingly)

10

RIDGE COURSE - B - RIDGE

IF LESS THAN A FULL PANEL IS REQUIRED, MEASURE AND BEND IT TO SUIT. ALLOW 25mm - 38mm TURN UP AND NAIL TO RIDGE BOARD.

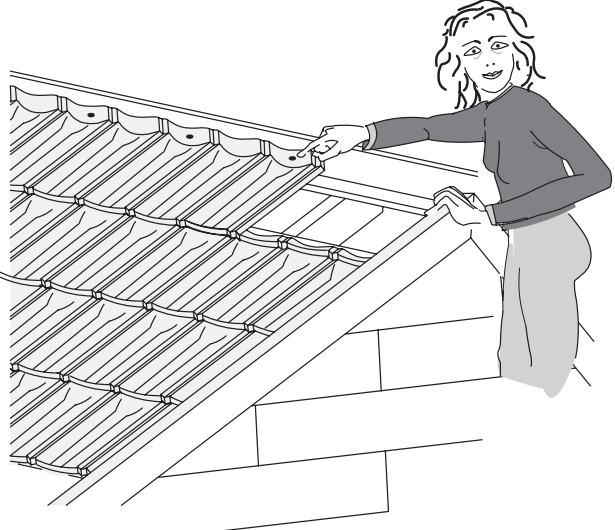

11

IF THE DISTANCE IS LESS THAN 120mm

YOU CAN USE A COVER FLASHING, ALLOWING A 25mm - 38mm MIN UP-TURN AGAINST THE RIDGE BOARD

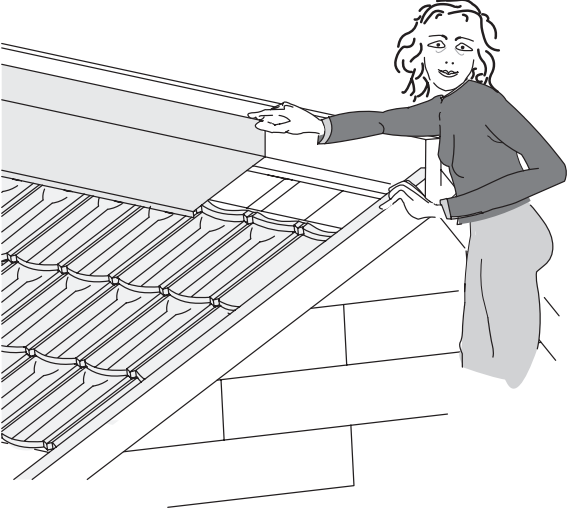

12

RIDGE COURSE - ANGLE RIDGE

FIX TWO TILE/SLATE BATTENS ON EITHER SIDE OF THE RIDGE. ADD AN ADDITIONAL TO THE REAR OF THE TWO TILE/SLATE BATTENS (50 X 25mm BATTEN TO SUIT THE ANGLE RIDGE). LAY TOP COURSE OF PANELS WITH BACK TURNED UP 25mm - 38mm

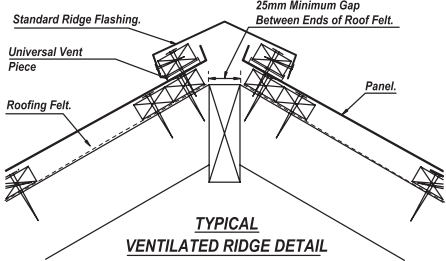

TYPICAL VENTILATED RIDGE DETAIL

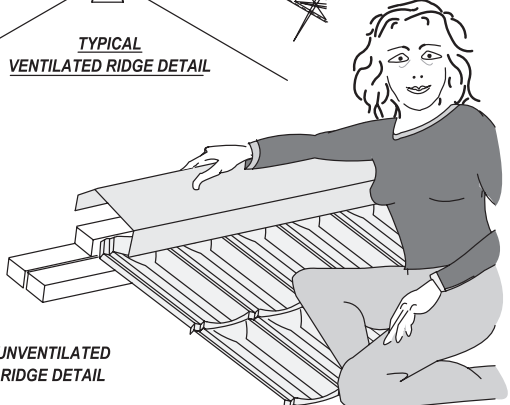

UNVENTILATED RIDGE DETAIL

**FIT THE BARGE BOARD
COVER OVER THE BARGE**

13

THE BARGE BOARDS ARE SCRIBED FOR LEFT & RIGHT HANDED USE.

THE END OF THE PANEL IS TURNED 25mm - 38mm UP AGAINST THE BARGE - 4 NAILS PER FLASHING

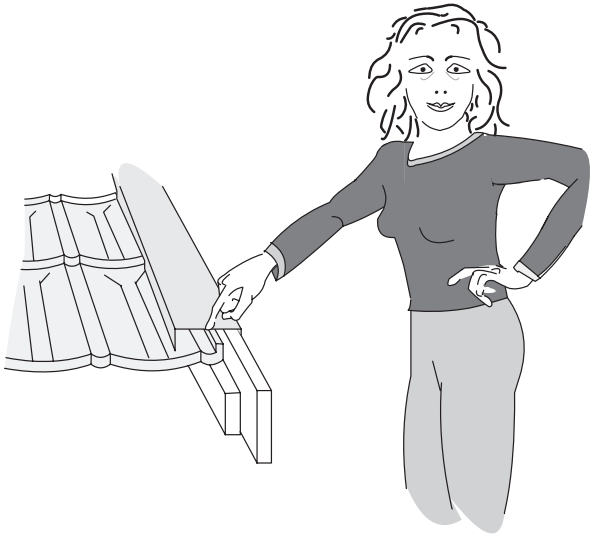

LEAD FLASHINGS

14

TURN THE PANEL UP 75mm AND COVER WITH A TRADITIONAL FLASHING. THE BACK OF THE CHIMNEY TO BE FLASHED AS PER TRADITIONAL METHOD.

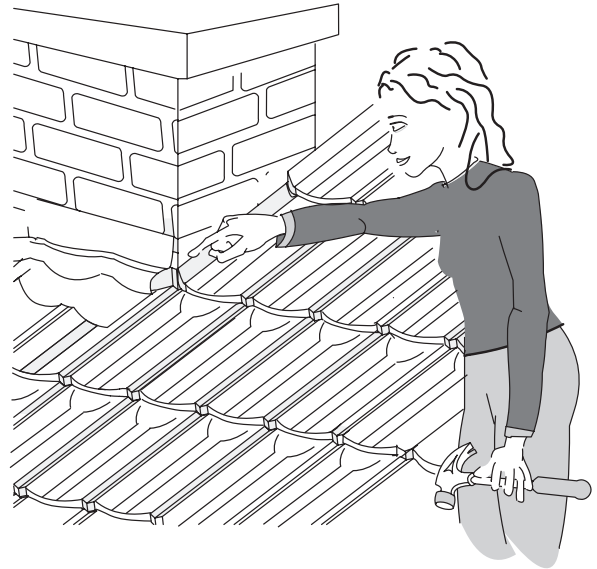

ANGLE HIP DETAIL

15

PLACE THE FIRST FULL PANEL BETWEEN 50mm AND 225mm FROM HIP BATTEN, LAYING SUBSEQUENT COURSES TO FOLLOW THE HIP LINE

TURN END OF THE PANEL UP AGAINST FRONT OF HIP BATTEN

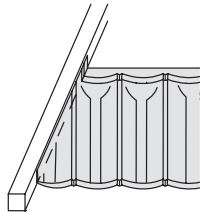

ENSURE THAT PROFILES LINE UP

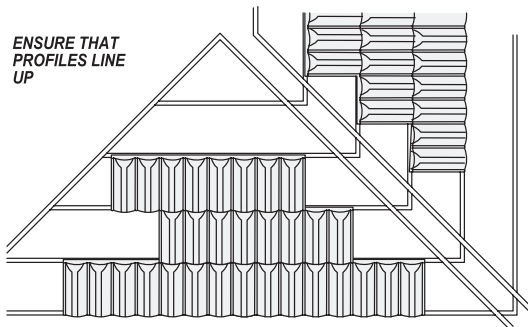

ANGLE HIP DETAIL

16

BEND UP PANEL EDGE 25mm - 38mm TO HIP BATTEN AND FIX THE HIP RIDGE IN THE SAME WAY AS THE ANGLE RIDGE

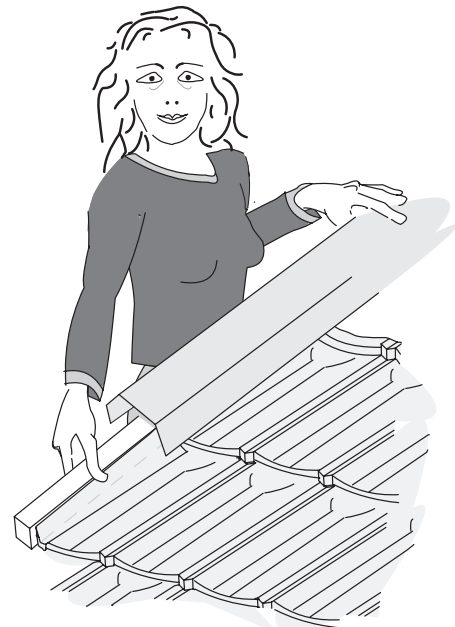

B-RIDGE END CAPS

17

NAIL THROUGH SIDES OF RIDGE AND ALLOW AN OVER HANG. CUT AND FOLD (AS SHOWN) AND NAIL THROUGH THE END

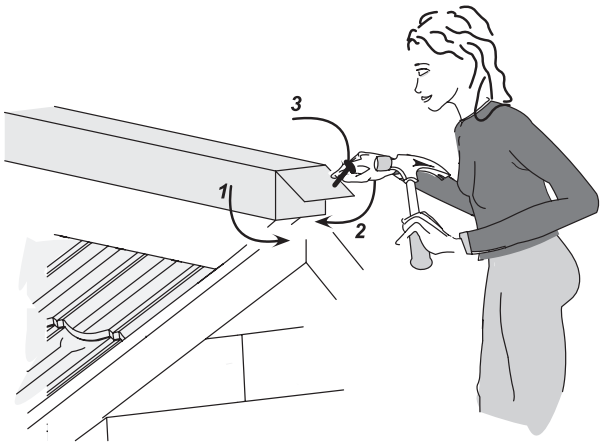

FINISHING ANGLE RIDGE ENDS

18

THE ANGLE RIDGE END CAPS ARE NAILED THROUGH THE DOWN-TURN, INTO THE BATTEN - 4 PER TILE.

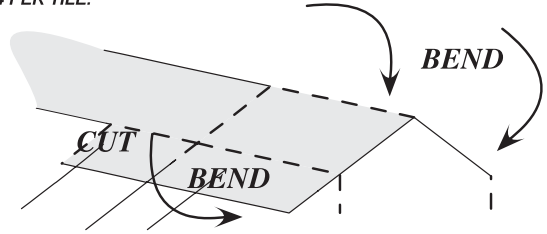

AT THE ENDS, CUT TO ALLOW SUFFICIENT DOWN TURN TO COVER THE BARGE AND FOLD AS SHOWN.

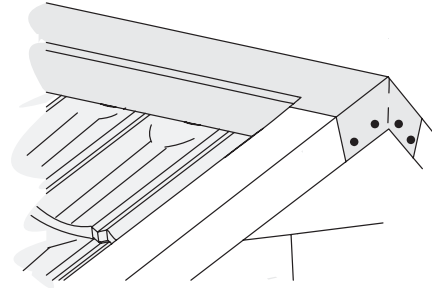

VALLEYS

19

VALLEY BOARDS TO BE LAID AT RAFTER LEVEL

CUT BATTENS TO RAKE, PROJECTING OVER VALLEY TO 65mm SHORT OF CENTRE LINE

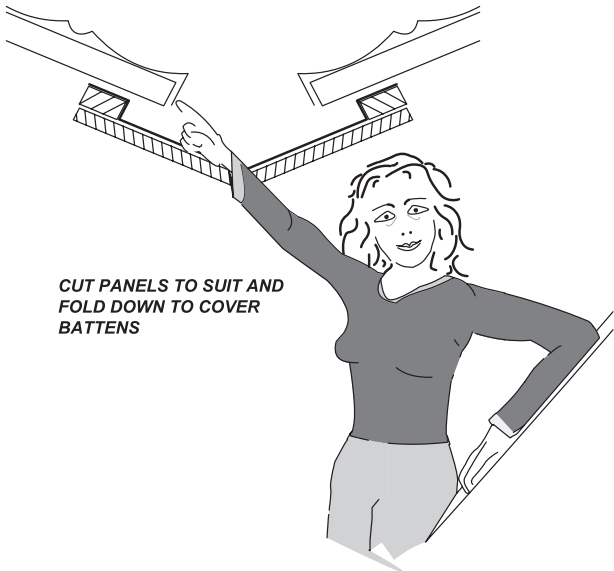

CUT PANELS TO SUIT AND FOLD DOWN TO COVER BATTENS

INDEX TO TECHNICAL DRAWINGS

TILE PANEL

PAGE	DRAWING NUMBER	DESCRIPTION
6	SK-40	Dimensional Information. (Slate 2000, Ultratile, Profile 49, Plain Tile, Villatile)
6	SK-41	Typical Fixing Detail.
7	SK-42	Batten Spacing.
7	SK-43	Standard Flashings. Angle Ridge/Hip, Barge Board, Cover and Eaves Apron.
7	SK-44	Standard Flashings. Apron, Upstand and Valley.
7	SK-45	Typical Ventilated Ridge Detail.
8	SK-46	Typical Ventilated Mono Ridge Detail.
8	SK-47	Typical Ventilated Eaves Detail.
8	SK-48	Typical Barge Detail.
8	SK-49	Typical Hip Detail.
9	SK-50	Typical GRP Valley Detail.
9	SK-51	Sunpipe/Roof Penetration Detail
9	SK-52	Typical Ventilated Ridge Detail.



The drawing is the property of Birmat (Ireland) Limited, and may not be copied without their express permission.

Product Plain Tile Ultratile Villatile Slate 2000 Profile 49	Title Dimensional Information. Horizontal Panel.	Drawn by Second Base Limited Scale N.T.S.	Date Jan 00
The drawing is the property of Birmat (Ireland) Limited, and may not be copied without their express permission.			

The drawing is the property of Birmat (Ireland) Limited, and may not be copied without their express permission.

Product Plain Tile Ultratile Villatile Slate 2000. Profile 49	Title Typical Fixing Detail All Panels to be laid broken bonded	Drawn by Second Base Limited Scale N.T.S.	Date Jan 00
The drawing is the property of Birmat (Ireland) Limited, and may not be copied without their express permission.			

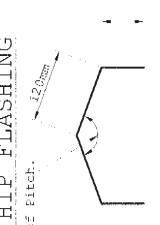
LIGHTWEIGHT TILE PANEL TECHNICAL INFORMATION

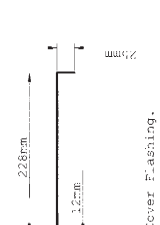
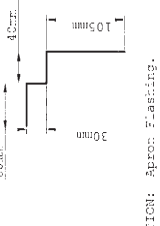
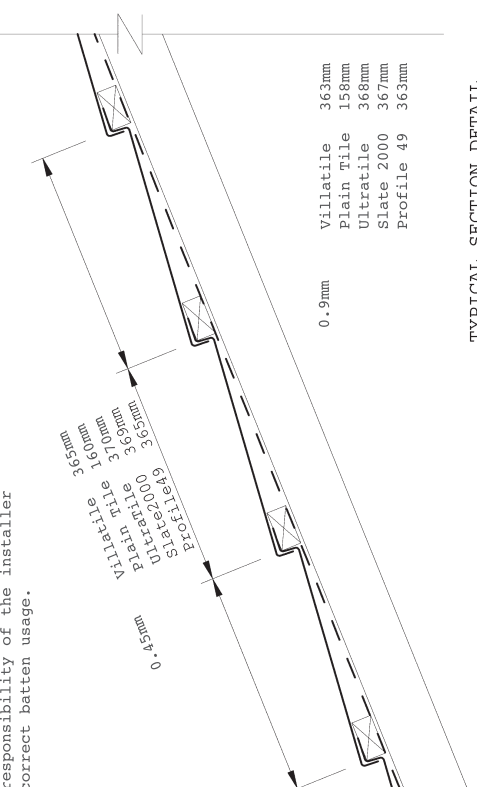
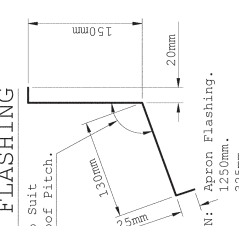
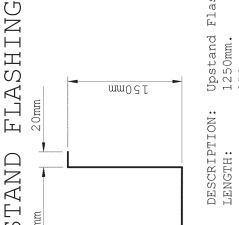
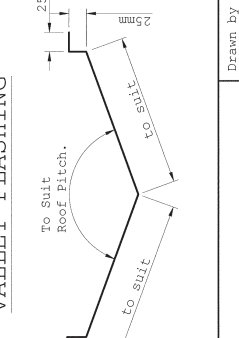
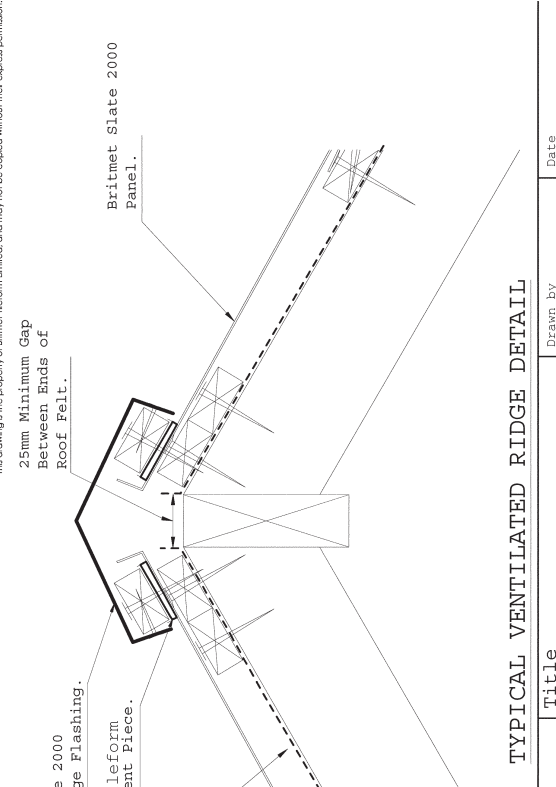
<p>P. RIDGE/HIP FLASHING To Suit Roof Pitch.</p>  <p>DESCRIPTION: Angle Ridge/Hip Flashing. LENGTH: 1250mm. GIRTH: 380mm. BENDS: 3 no.</p>	<p>BARGE BOARD FLASHING</p>  <p>DESCRIPTION: Barge Board Flashing. LENGTH: 1250mm. GIRTH: 230mm. BENDS: 3 no.</p>	<p>COVER FLASHING</p>  <p>DESCRIPTION: Cover Flashing. LENGTH: 2250mm. GIRTH: 265mm. BENDS: 2 no.</p>	<p>EAVES APRON FLASHING</p>  <p>DESCRIPTION: Apron Flashing. LENGTH: 2250mm. GIRTH: 235mm. BENDS: 3 no.</p>	<p>TYPICAL SECTION DETAIL</p>  <p>It is the responsibility of the installer to ensure correct batten usage.</p> <p>0.9mm Villatile 363mm Plain Tile 158mm Ultratile 368mm Slate 2000 367mm Profile 49 363mm</p>	<p>Product Ultratile Slate 2000 Profile 49</p> <p>Title Batten Spacing.</p> <p>Drawn by Second Base Limited</p> <p>Date Jan 00</p> <p>Scale N.T.S.</p> <p>Drawing No. SK - 42</p>	<p>Product Ultratile Slate 2000 Profile 49</p> <p>Title Standard Flashings. Angle Ridge/Hip, Barge Board, Cover and Eaves Apron.</p> <p>Drawn by Second Base Limited</p> <p>Date Jan 00</p> <p>Scale N.T.S.</p> <p>Drawing No. SK - 43</p>	<p>Product Ultratile Slate 2000 Profile 49</p> <p>Title Plain Tile Villatile</p> <p>Drawn by Second Base Limited</p> <p>Date Jan 00</p> <p>Scale N.T.S.</p> <p>Drawing No. SK - 44</p>	<p>APRON FLASHING To Suit Roof Pitch.</p>  <p>DESCRIPTION: Apron Flashing. LENGTH: 1250mm. GIRTH: 325mm. BENDS: 3 no.</p>	<p>SIDEWALL/UPSTAND FLASHING</p>  <p>DESCRIPTION: Upstand Flashing. LENGTH: 1250mm. GIRTH: 350mm. BENDS: 3 no.</p>	<p>VALLEY FLASHING</p>  <p>DESCRIPTION: Valley Flashing LENGTH: 1250mm. GIRTH: 500mm. BENDS: 5 no.</p> <p>Product Ultratile Slate 2000 Profile 49</p> <p>Title Standard Flashings. Apron, Upstand and Valley.</p> <p>Drawn by Second Base Limited</p> <p>Date Jan 00</p> <p>Scale N.T.S.</p> <p>Drawing No. SK - 44</p>	<p>Product Ultratile Slate 2000 Profile 49</p> <p>Title Plain Tile Villatile</p> <p>Drawn by Second Base Limited</p> <p>Date Jan 00</p> <p>Scale N.T.S.</p> <p>Drawing No. SK - 45</p>	<p>Product Ultratile Slate 2000 Profile 49</p> <p>Title Plain Tile Villatile</p> <p>Drawn by Second Base Limited</p> <p>Date Jan 00</p> <p>Scale N.T.S.</p> <p>Drawing No. SK - 45</p>
<p>TYPICAL VENTILATED RIDGE DETAIL</p>  <p>25mm Minimum Gap Between Ends of Roof Felt.</p> <p>Britmet Slate 2000 Standard Ridge Flashing.</p> <p>Britmet Tileform Universal Vent Piece.</p> <p>Roofing Felt.</p> <p>Britmet Slate 2000 Panel.</p>												

LIGHTWEIGHT TILE PANEL TECHNICAL INFORMATION

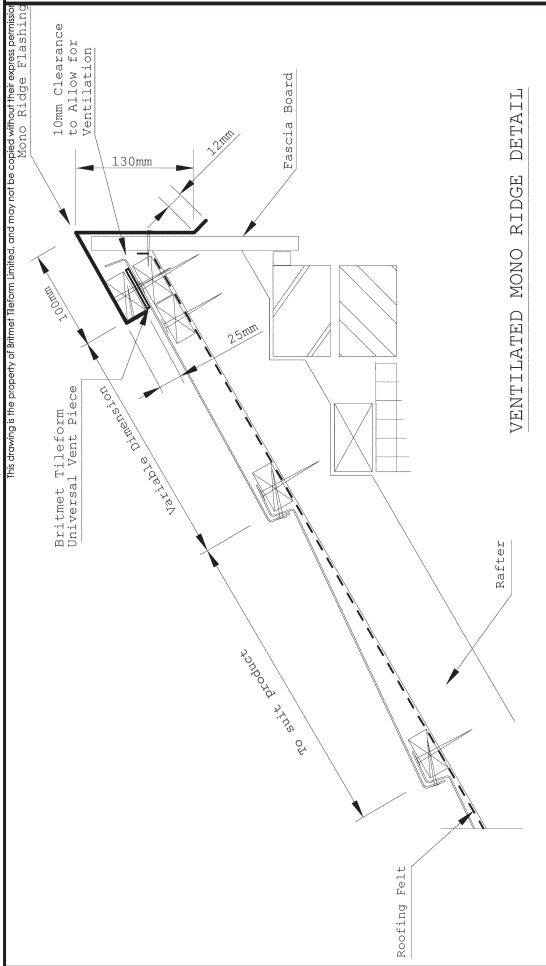

VENTILATED MONO RIDGE DETAIL

Product Ultratile Slate 2000 Profile 49	Title Typical Ventilating Mono Ridge Detail.	Drawn by Second Base Limited	Date Jan 02
		Scale N.T.S.	Drawing No. SK - 46

The drawing is the property of Britmet Tileform Limited, and may not be copied without their express permission.

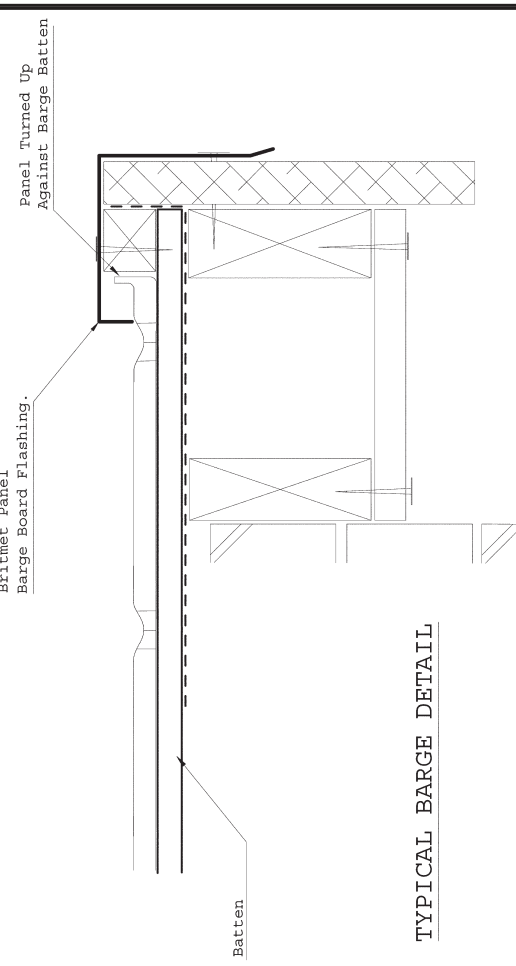

TYPICAL BARGE DETAIL

Product Ultratile Slate 2000 Profile 49	Title Typical Barge Detail.	Drawn by Second Base Limited	Date Jan 02
		Scale N.T.S.	Drawing No. SK - 48

The drawing is the property of Britmet Tileform Limited, and may not be copied without their express permission.

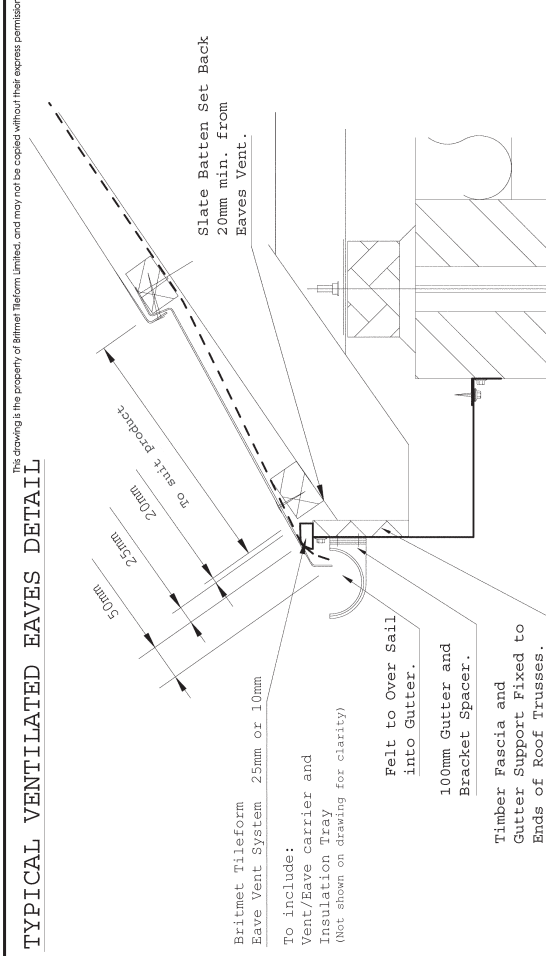

TYPICAL VENTILATED EAVES DETAIL

Product Ultratile Slate 2000 Profile 49	Title Typical Ventilating Eaves Detail.	Drawn by Second Base Limited	Date Jan 02
		Scale N.T.S.	Drawing No. SK - 47

The drawing is the property of Britmet Tileform Limited, and may not be copied without their express permission.

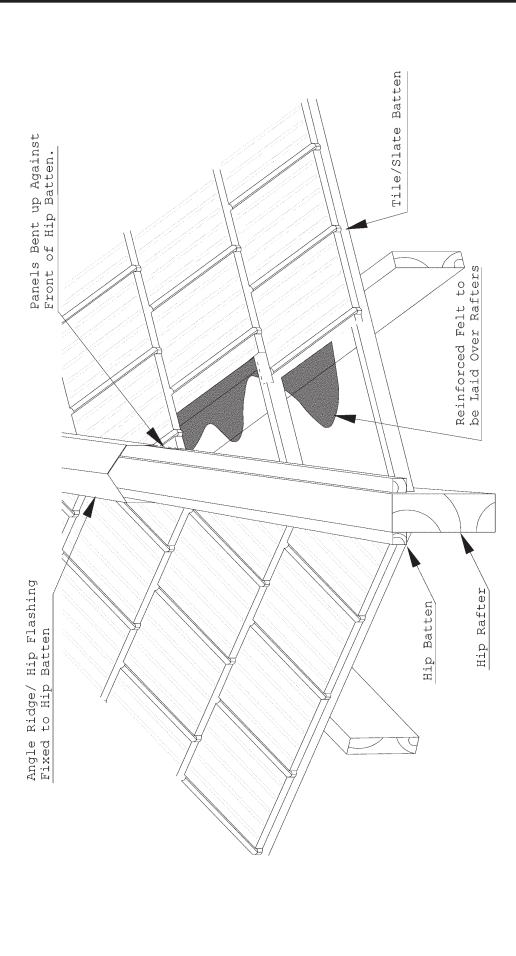

Product Ultratile Slate 2000 Profile 49	Title Typical Hip Detail.	Drawn by Second Base Limited	Date Jan 02
		Scale N.T.S.	Drawing No. SK - 49

The drawing is the property of Britmet Tileform Limited, and may not be copied without their express permission.

LIGHTWEIGHT TILE PANEL TECHNICAL INFORMATION

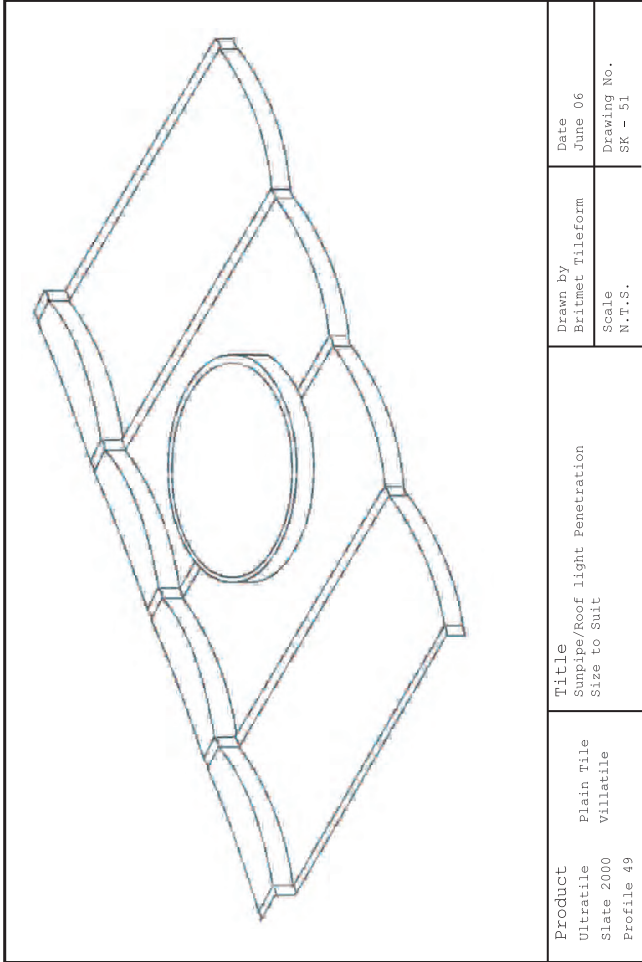

Product Ultratile Slate 2000 Profile 49	Title Plain Tile Villatille	Title Sunpipe/Roof light Penetration Size to Suit	Drawn by Britmet Tileform Scale N.T.S.	Date June 06 Drawing No. SK - 51
---	--	--	--	--

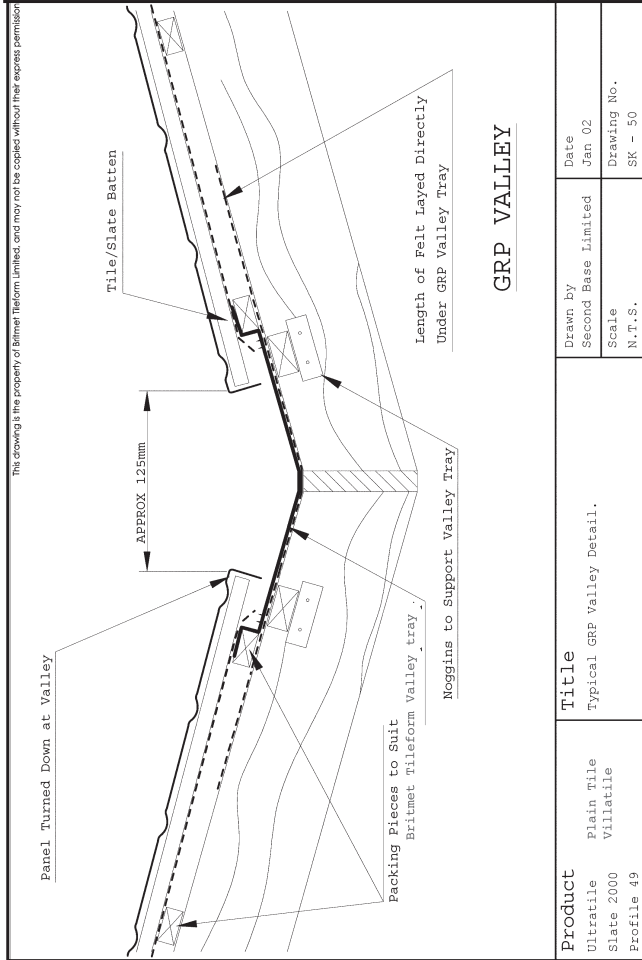

GRP VALLEY

Product Ultratile Slate 2000 Profile 49	Title Plain Tile Villatille	Title Typical GRP Valley Detail.	Drawn by Second Base Limited Scale N.T.S.	Date Jan 02 Drawing No. SK - 50
---	--	--	---	---

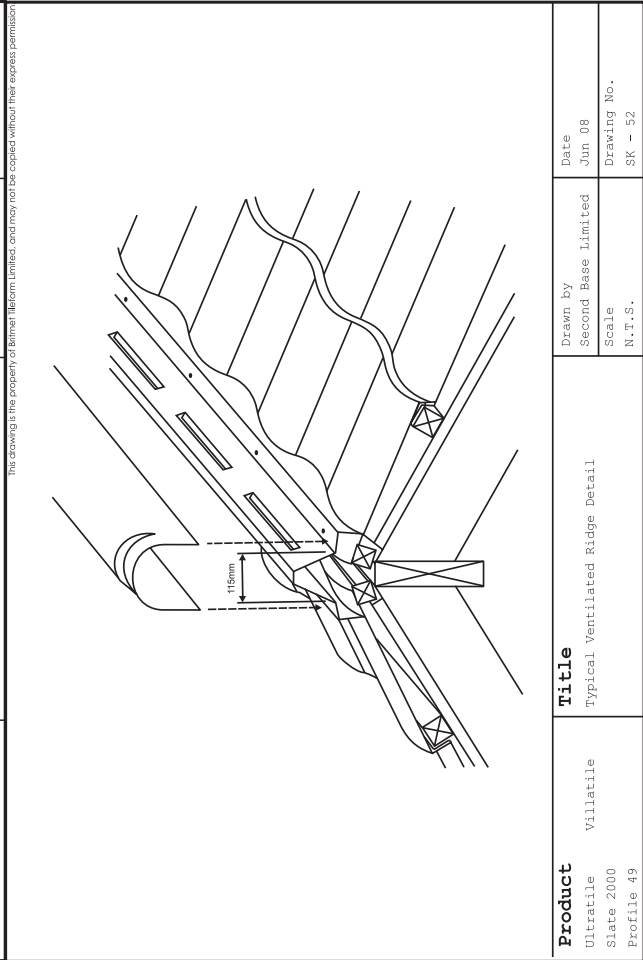

Product Ultratile Slate 2000 Profile 49	Title Villatille	Title Typical Ventilated Ridge Detail	Drawn by Second Base Limited Scale N.T.S.	Date Jun 08 Drawing No. SK - 52
---	----------------------------	---	---	---

The Britmet Tileform roofing systems have been designed and are manufactured to high industry standards. They are easy to install and will perform within the design criteria. The following brief instructions covering the main items on handling and fixing have been prepared to assist those fixing or supervising installations and should be observed. Full technical information and assistance are available on request.

The Britmet tile can be laid on roofs with a minimum pitch of 5 degrees.

HANDLING AND STORAGE

Materials should be unloaded as close as possible to the building where they are to be installed. On site, packs should be stored on a firm, dry base away from the possibility of damage.

Sheeting packs should be laid on pallets or bearers to allow ground clearance. Bearers at least 100mm x 50mm should be arranged at the same centres under each pack, which must not exceed 2 packs high and must slope sufficiently to allow any rainwater which penetrates to drain away. A tarpaulin should cover the stacks not touching the surface of the sheets, this allows for circulation of air.

To prevent damage to the coating on installation, the sheets must be lifted not dragged from the pack. Damage to the surface coating can be repaired with touch-up paint. (Supplied by Britmet Tileform Ltd.)

SHEET LENGTHS

Where sheet lengths can be accurately pre-determined, they are available in one piece from ridge to eaves to a length of 7.5 metres. Where the slope length exceeds 7.5 metres, or to suit site limitations, sheets are available in a combination of lengths and end/head lapped with mitred cut, to suit eaves to ridge measurements.

FIG 1a. BATTEN/PURLIN LAYOUT (RIDGE DETAIL)

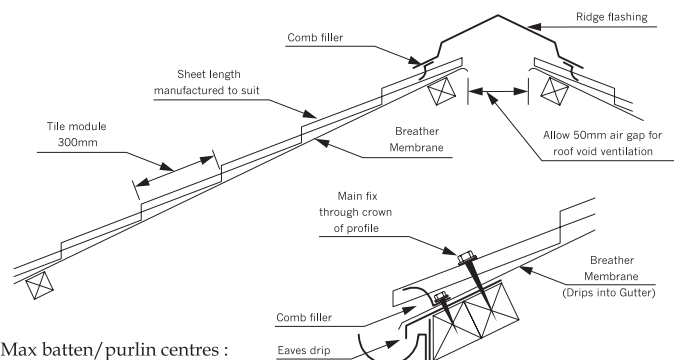

Max batten/purlin centres :

1.5 metres for 0.9mm sheets.

FIG 1b. EAVES DETAIL

EAVES DRIP FLASHING

The eaves drip flashing must be set out square to the eaves using a string line. The front edge of the drip should run to the centre line of the gutter. The front edge of the eaves drip can be used as a template for aligning the front edge of the sheet (providing the eaves drip is square to the eaves).

Note: The breather membrane should be laid over the eaves drip flush with the front edge
Note: The comb fillers should sit on top of and be fixed through the breather membrane & eaves drip into the eaves purlin. (See fig. 1b for detail)

TILE SHEET LAYING SEQUENCE

Britmet Tileform roof sheets must be laid from right to left. (see Fig.2). The first sheet must be laid square with itself and to the eaves, not the gable or abutment. However, with the exception of a hip ended roof, the tile sheets will have to be laid in reverse (i.e. back lapped) from the first uncut sheet. All side laps must be facing the same way.

□IG 2□ BYI 3□□

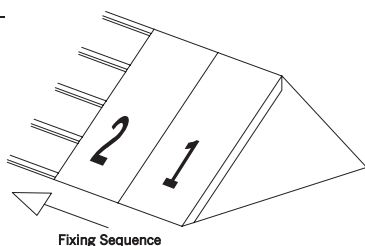

SIDE LAPS

Side lap stitching screws are used to tighten the side lap (See fig. 4 for fixing locations).

A butyl mastic bead should be laid full length along the crown of the profile of the section to be lapped.

Note: For roof pitches of 5° - 9° the butyl mastic bead must be 10mm diameter min.
For roof pitches of 10° - 90° the butyl mastic bead must be 6mm diameter min.

END/HEAD LAPS (Must be Mitred)

For a roof pitch of 5° - 9° the end lap must be a min. 300mm on the eaves sheet.
 For a roof pitch of 10° - 90° the end lap must be a min. 75mm on the eaves sheet.

CUTTING

Lay the tile sheet down on soft, clean, flat surface and mark the lines to be cut. Cutting to be carried out from the reverse side of the sheet using either a 110-volt corrugated nibbler or 110-volt jigsaw. All cut edges to be treated immediately with the touch up kit provided by Britmet Tileform Limited.

MAIN SHEET FIXINGS

All main sheet fixings must be through the crown of the profile using Tek screws supplied by Britmet Tileform Ltd. (for fixing quantities and locations see fig.4)

FIG 3. FIXING POSITIONS - SIDE LAP AND MAIN FIXING DETAIL

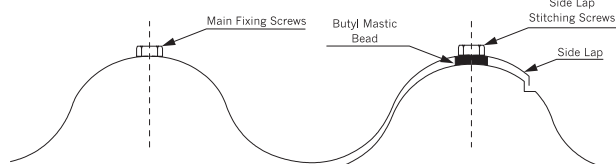

Note: For coastal areas, stainless steel fixings must be used.

FIG 4. TYPICAL FIXING LOCATIONS (CROWN FIX ONLY)

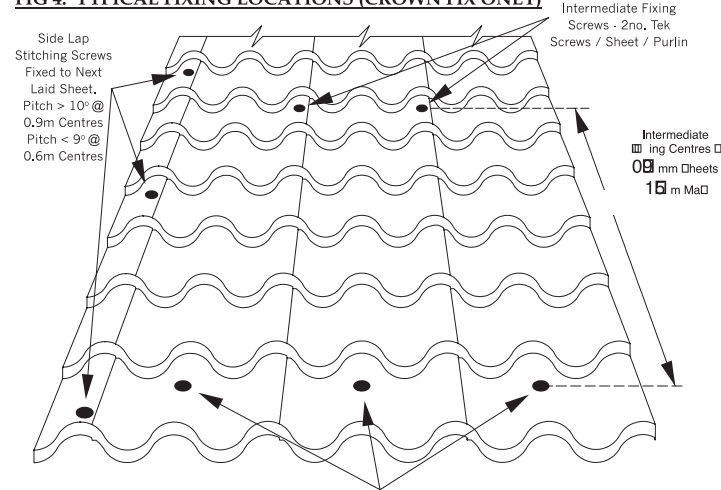

Note: The above is only a guide, fixing quantities can vary due to building exposure and regional wind loadings.

FLASHINGS

For the full range of flashings, see the Britmet Tileform technical information. Manufactured length 2m.

Note: comb fillers should be used at the ridge, hip & valley

FLASHING FIXINGS

Unless otherwise stated, all flashings are to be fixed using stitching screws (provided by Britmet Tileform Ltd). Minimum fixing requirements: 3no. fixings per side per flashing. Flashings to be jointed with a 50mm butt strap, or lapped 50mm.

ROOF SHEET PENETRATIONS

The weathering of all penetration i.e. soil and vent or similar, should be carried out with a Dektite flashing, fixed in accordance with the manufacturers instructions. Dektite flashings are available from Britmet Tileform Ltd.

ROOFLIGHTS AND CHIMNEYS

Britmet Tileform tile sheets should be cut in situ to fit neatly around the penetration. Purpose made flashings are available from Britmet Tileform Ltd.

Note: The above is a guide on how to fix the Britmet Tileform ridge to eaves tile sheets.

This fixing guide assumes that the new or existing roof structure is of sound condition and is built in accordance with the latest building code of practices.

The Britmet Tileform roofing systems have been designed and are manufactured to high industry standards. They are easy to install and will perform within the design criteria. The following brief instructions covering the main items on handling and fixing have been prepared to assist those fixing or supervising installations and should be observed. Full technical information and assistance are available on request.

The Britmet tile can be laid on roofs with a minimum pitch of 5 degrees.

HANDLING AND STORAGE

Materials should be unloaded as close as possible to the building where they are to be installed. On site, packs should be stored on a firm, dry base away from the possibility of damage.

Sheeting packs should be laid on pallets or bearers to allow ground clearance. Bearers at least 100mm x 50mm should be arranged at the same centres under each pack, which must not exceed 2 packs high and must slope sufficiently to allow any rainwater which penetrates to drain away. A tarpaulin should cover the stacks not touching the surface of the sheets, this allows for circulation of air.

To prevent damage to the coating on installation, the sheets must be lifted not dragged from the pack. Damage to the surface coating can be repaired with touch-up paint. (Supplied by Britmet Tileform Ltd.)

SHEET LENGTHS

Where sheet lengths can be accurately pre-determined, they are available in one piece from ridge to eaves to a length of 6 metres. Where the slope length exceeds 6 metres, or to suit site limitations, sheets are available in a combination of lengths and end/head lapped with mitred cut, to suit eaves to ridge measurements.

FIG 1a. BATTEN/PURLIN LAYOUT (RIDGE DETAIL)

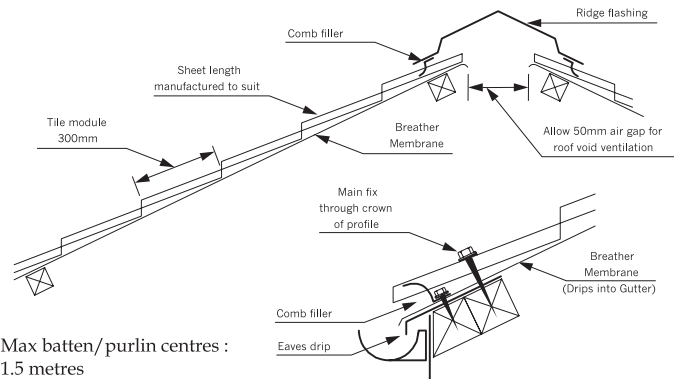

FIG 1b. EAVES DETAIL

EAVES DRIP FLASHING

The eaves drip flashing must be set out square to the eaves using a string line. The front edge of the drip should run to the centre line of the gutter. The front edge of the eaves drip can be used as a template for aligning the front edge of the sheet (providing the eaves drip is square to the eaves).

Note: The breather membrane should be laid over the eaves drip flush with the front edge
Note: The comb fillers should sit on top of and be fixed through the breather membrane & eaves drip into the eaves purlin. (See fig. 1b for detail)

TILE SHEET LAYING SEQUENCE

Britmet Tileform roof sheets must be laid from right to left. (see Fig.2). The first sheet must be laid square with itself and to the eaves, not the gable or abutment. However, with the exception of a hip ended roof, the tile sheets will have to be laid in reverse (i.e. back lapped) from the first uncut sheet. All side laps must be facing the same way.

FIG 2. LAYING SEQUENCE

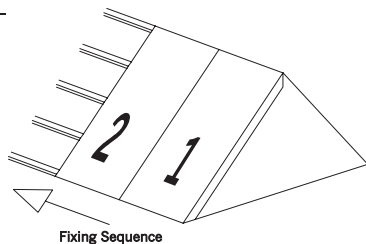

SIDE LAPS

Side lap stitching screws are used to tighten the side lap (See fig. 4 for fixing locations).

A butyl mastic bead should be laid full length along the crown of the profile of the section to be lapped.

Note: For roof pitches of 5° - 9° the butyl mastic bead must be 10mm diameter min.
For roof pitches of 10° - 90° the butyl mastic bead must be 6mm diameter min.

END/HEAD LAPS (Must be Mitred)

For a roof pitch of 5° - 9° the end lap must be a min. 300mm on the eaves sheet.
 For a roof pitch of 10° - 90° the end lap must be a min. 75mm on the eaves sheet.

CUTTING

Lay the tile sheet down on soft, clean, flat surface and mark the lines to be cut. Cutting to be carried out from the reverse side of the sheet using either a 110-volt corrugated nibbler or 110-volt jigsaw. All cut edges to be treated immediately with the touch up kit provided by Britmet Tileform Limited.

MAIN SHEET FIXINGS

All main sheet fixings must be through the crown of the profile using Tek screws supplied by Britmet Tileform Ltd. (for fixing quantities and locations see fig.4)

FIG 3. FIXING POSITIONS - SIDE LAP AND MAIN FIXING DETAIL

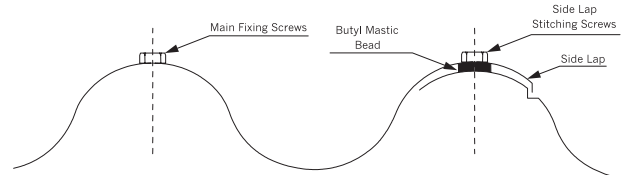

Note: For coastal areas, stainless steel fixings must be used.

FIG 4. TYPICAL FIXING LOCATIONS (CROWN FIX ONLY)

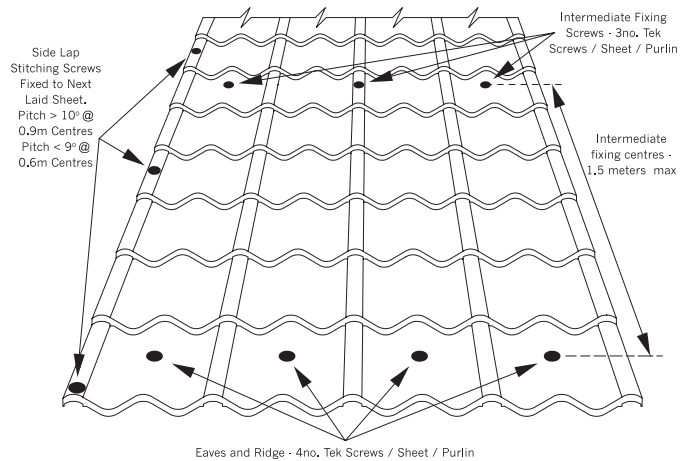

Note: The above is only a guide, fixing quantities can vary due to building exposure and regional wind loadings.

FLASHINGS

For the full range of flashings, see the Britmet Tileform technical information. Manufactured length 2m.

Note: comb fillers should be used at the ridge, hip & valley

FLASHING FIXINGS

Unless otherwise stated, all flashings are to be fixed using stitching screws (provided by Britmet Tileform Ltd).
 Minimum fixing requirements: 3no. fixings per side per flashing.
 Flashings to be jointed with a 50mm butt strap, or lapped 50mm.

ROOF SHEET PENETRATIONS

The weathering of all penetration i.e. soil and vent or similar, should be carried out with a Dektite flashing, fixed in accordance with the manufacturers instructions. Dektite flashings are available from Britmet Tileform Ltd.

ROOFLIGHTS AND CHIMNEYS

Britmet Tileform tile sheets should be cut in situ to fit neatly around the penetration. Purpose made flashings are available from Britmet Tileform Ltd.

Note: The above is a guide on how to fix the Britmet Tileform ridge to eaves tile sheets.

This fixing guide assumes that the new or existing roof structure is of sound condition and is built in accordance with the latest building code of practices.

INDEX TO TECHNICAL DRAWINGS

EAVE TO RIDGE TILE SHEET







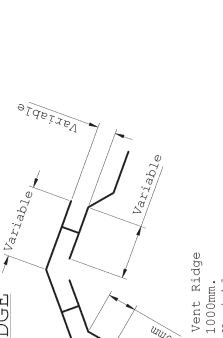

PAGE	DRAWING NUMBER	DESCRIPTION
13	SK-01	Dimensional Information. (Boldroll)
13	SK-02	Lapping Details. Side/Head Lap. (Boldroll)
13	SK-03	Dimensional Information. (Pantile 2000)
13	SK-04	Standard Flashings. Ridge/Hip, Verge/Barge, Eaves Drip and Apron.
14	SK-05	Standard Flashings. Upstand, Mono Ridge, Eaves Fascia/Soffit and Verge Fascia/Soffit.
14	SK-06	Standard Flashings. Junction, Valley and Vent Ridge.
14	SK-07	Lapping Details. Side/Head Lap. (Pantile 2000)
14	SK-08	Sheet Mitre Detail at Head Lap.
15	SK-09	Typical Ventilated Eaves Detail. Steel Substructure.
15	SK-10	Typical Ridge Detail. Steel Substructure.
15	SK-11	Typical Verge Detail. Steel Substructure.
15	SK-12	Typical Hip Detail. Steel Substructure. Cut Away Detail.
16	SK-13	Typical Valley Detail. Steel Substructure. Cut Away Detail.
16	SK-14	Typical Mono Ridge Detail. Steel Substructure.
16	SK-15	Typical Ventilated Eaves Detail. Timber Substructure.
16	SK-16	Typical Ridge Detail. Timber Substructure.
17	SK-17	Typical Verge Detail. Timber Substructure.
17	SK-18	Typical Hip Detail. Timber Substructure. Cut Away Detail.
17	SK-19	Typical Valley Detail. Timber Substructure. Cut Away Detail.
17	SK-20	Typical Mono Ridge Detail. Timber Substructure.
18	SK-21	Typical Eaves Detail. Steel Substructure. Insulation and Liner Tray.
18	SK-22	Typical Ridge Detail. Steel Substructure. Insulation and Liner Tray.
18	SK-23	Typical Hip Detail. Steel Substructure. Insulation and Liner Tray. Cut Away Detail.
18	SK-24	Typical Valley Detail. Steel Substructure. Insulation and Liner Tray. Cut Away Detail.
19	SK-25	Typical Verge Detail. Steel Substructure. Insulation and Liner Tray.
19	SK-26	Typical Mono Ridge Detail. Steel Substructure. Insulation and Liner Tray.
19	SK-27	Typical Lead Flashing Detail to Chimney. Chimney at Ridge.
19	SK-28	Typical Lead Flashing Detail to Chimney. Chimney within Roof Slope.
20	SK-29	Typical Apron Flashing Detail.
20	SK-30	Typical Upstand Flashing Detail.
20	SK-31	Typical Detail at Change in Slope.
20	SK-32	Typical Detail at Translucent Sheet. Plan and Section.
21	SK-33	Typical Aluminium Gas Vent Ridge Detail.
21	SK-34	Typical Air Vent Ridge and Soil Vent Ridge Detail.
21	SK-35	Typical Detail at a Box Gutter.
21	SK-36	Sunpipe/Roof Light Penetration Detail.

LIGHTWEIGHT EAVE TO RIDGE TILE SHEET

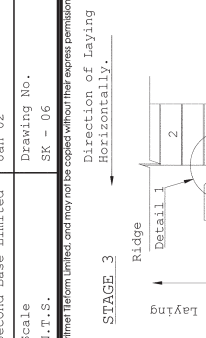
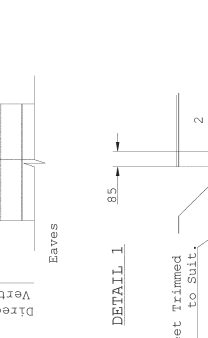
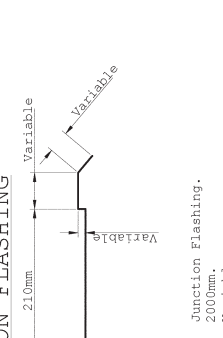
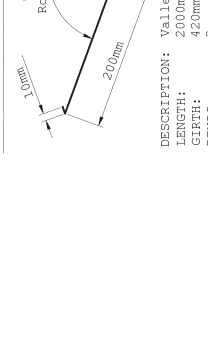
TECHNICAL INFORMATION

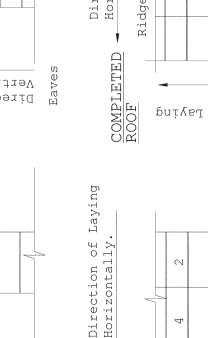
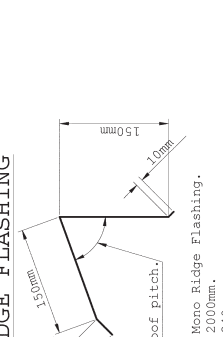
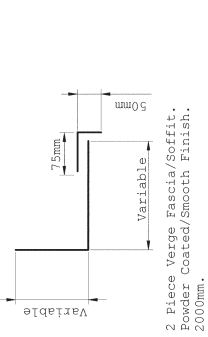
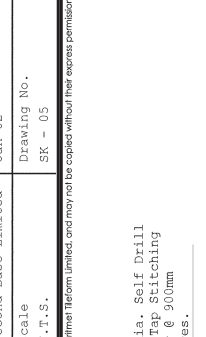
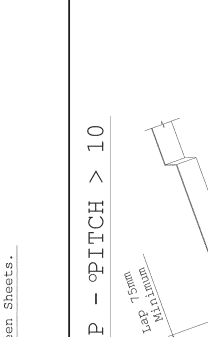
<p style="font-size: small;">This drawing is the property of Bimetal Tileform Limited, and may not be copied without their express permission.</p> <h3 style="text-align: center;">SIDE LAP</h3> <p style="font-size: small;">6mm dia. Self Drill Self Tap Screws @ 900mm Centres. 6mm Thick Mastic Seal, Along Crown, Compressed Between Sheets.</p>	<p style="font-size: small;">This drawing is the property of Bimetal Tileform Limited, and may not be copied without their express permission.</p> <h3 style="text-align: center;">HEAD LAP - PITCH < 10</h3> <p style="text-align: center;">Lap 300mm Minimum.</p> <h3 style="text-align: center;">HEAD LAP - PITCH > 10</h3> <p style="text-align: center;">Lap 75mm Minimum.</p>																
<p style="font-size: small;">This drawing is the property of Bimetal Tileform Limited, and may not be copied without their express permission.</p> <p style="text-align: center;">SECTION A-A</p> <p style="text-align: center;">SECTION B-B</p>	<p style="font-size: small;">This drawing is the property of Bimetal Tileform Limited, and may not be copied without their express permission.</p> <h3 style="text-align: center;">RIDGE/HIP FLASHING</h3> <p style="text-align: center;">To Suit Roof Pitch.</p> <p style="font-size: small;">DESCRIPTION: Ridge/Hip Flashing. LENGTH: 2000mm. GIRTH: 400mm. BENDS: 5 no. DETAIL: End Cap to Suit.</p> <h3 style="text-align: center;">VERGE/BARGE FLASHING</h3> <p style="font-size: small;">DESCRIPTION: Verge/Barge Flashing. LENGTH: 2000mm. GIRTH: 340mm. BENDS: 3 no. DETAIL: End Cap to Suit.</p>																
<p style="font-size: small;">This drawing is the property of Bimetal Tileform Limited, and may not be copied without their express permission.</p> <h3 style="text-align: center;">EAVES DRIP FLASHING</h3> <p style="font-size: small;">DESCRIPTION: Eaves Drip Flashing Sheets only. LENGTH: 2000mm. GIRTH: 140mm. BENDS: 1 no.</p>	<p style="font-size: small;">This drawing is the property of Bimetal Tileform Limited, and may not be copied without their express permission.</p> <h3 style="text-align: center;">APRON FLASHING</h3> <p style="font-size: small;">DESCRIPTION: Apron Flashing. LENGTH: 2000mm. GIRTH: 300mm. BENDS: 2 no.</p>																
<p style="font-size: small;">This drawing is the property of Bimetal Tileform Limited, and may not be copied without their express permission.</p> <table border="1" style="width: 100%; border-collapse: collapse;"> <tr> <td style="width: 25%;">Product Boldroll. Ridge to Eaves Tile-Effect Sheet.</td> <td style="width: 25%;">Title Lapping Details. Side/Head Lap.</td> <td style="width: 25%;">Drawn by Second Base Limited</td> <td style="width: 25%;">Date Jan 02</td> </tr> <tr> <td>Scale N.T.S.</td> <td>Scale N.T.S.</td> <td>Scale N.T.S.</td> <td>Drawing No. SK - 02</td> </tr> </table> <p style="text-align: center;">Lapped over supported areas only.</p>	Product Boldroll. Ridge to Eaves Tile-Effect Sheet.	Title Lapping Details. Side/Head Lap.	Drawn by Second Base Limited	Date Jan 02	Scale N.T.S.	Scale N.T.S.	Scale N.T.S.	Drawing No. SK - 02	<table border="1" style="width: 100%; border-collapse: collapse;"> <tr> <td style="width: 25%;">Product Boldroll. Ridge to Eaves Tile-Effect Sheet.</td> <td style="width: 25%;">Title Lapping Details. Side/Head Lap.</td> <td style="width: 25%;">Drawn by Second Base Limited</td> <td style="width: 25%;">Date Jan 02</td> </tr> <tr> <td>Scale N.T.S.</td> <td>Scale N.T.S.</td> <td>Scale N.T.S.</td> <td>Drawing No. SK - 02</td> </tr> </table> <p style="text-align: center;">Lapped over supported areas only.</p>	Product Boldroll. Ridge to Eaves Tile-Effect Sheet.	Title Lapping Details. Side/Head Lap.	Drawn by Second Base Limited	Date Jan 02	Scale N.T.S.	Scale N.T.S.	Scale N.T.S.	Drawing No. SK - 02
Product Boldroll. Ridge to Eaves Tile-Effect Sheet.	Title Lapping Details. Side/Head Lap.	Drawn by Second Base Limited	Date Jan 02														
Scale N.T.S.	Scale N.T.S.	Scale N.T.S.	Drawing No. SK - 02														
Product Boldroll. Ridge to Eaves Tile-Effect Sheet.	Title Lapping Details. Side/Head Lap.	Drawn by Second Base Limited	Date Jan 02														
Scale N.T.S.	Scale N.T.S.	Scale N.T.S.	Drawing No. SK - 02														
<p style="font-size: small;">This drawing is the property of Bimetal Tileform Limited, and may not be copied without their express permission.</p> <table border="1" style="width: 100%; border-collapse: collapse;"> <tr> <td style="width: 25%;">Product Boldroll. Ridge to Eaves Tile-Effect Sheet.</td> <td style="width: 25%;">Title Dimensional Information.</td> <td style="width: 25%;">Drawn by Second Base Limited</td> <td style="width: 25%;">Date Jan 02</td> </tr> <tr> <td>Scale N.T.S.</td> <td>Scale N.T.S.</td> <td>Scale N.T.S.</td> <td>Drawing No. SK - 01</td> </tr> </table> <p style="text-align: center;">Lapped over supported areas only.</p>	Product Boldroll. Ridge to Eaves Tile-Effect Sheet.	Title Dimensional Information.	Drawn by Second Base Limited	Date Jan 02	Scale N.T.S.	Scale N.T.S.	Scale N.T.S.	Drawing No. SK - 01	<table border="1" style="width: 100%; border-collapse: collapse;"> <tr> <td style="width: 25%;">Product Boldroll. Ridge to Eaves Tile-Effect Sheet.</td> <td style="width: 25%;">Title Dimensional Information.</td> <td style="width: 25%;">Drawn by Second Base Limited</td> <td style="width: 25%;">Date Jan 02</td> </tr> <tr> <td>Scale N.T.S.</td> <td>Scale N.T.S.</td> <td>Scale N.T.S.</td> <td>Drawing No. SK - 01</td> </tr> </table> <p style="text-align: center;">Lapped over supported areas only.</p>	Product Boldroll. Ridge to Eaves Tile-Effect Sheet.	Title Dimensional Information.	Drawn by Second Base Limited	Date Jan 02	Scale N.T.S.	Scale N.T.S.	Scale N.T.S.	Drawing No. SK - 01
Product Boldroll. Ridge to Eaves Tile-Effect Sheet.	Title Dimensional Information.	Drawn by Second Base Limited	Date Jan 02														
Scale N.T.S.	Scale N.T.S.	Scale N.T.S.	Drawing No. SK - 01														
Product Boldroll. Ridge to Eaves Tile-Effect Sheet.	Title Dimensional Information.	Drawn by Second Base Limited	Date Jan 02														
Scale N.T.S.	Scale N.T.S.	Scale N.T.S.	Drawing No. SK - 01														
<p style="font-size: small;">This drawing is the property of Bimetal Tileform Limited, and may not be copied without their express permission.</p> <table border="1" style="width: 100%; border-collapse: collapse;"> <tr> <td style="width: 25%;">Product Boldroll. Ridge to Eaves Tile-Effect Sheet.</td> <td style="width: 25%;">Title Dimensional Information.</td> <td style="width: 25%;">Drawn by Second Base Limited</td> <td style="width: 25%;">Date Jan 02</td> </tr> <tr> <td>Scale N.T.S.</td> <td>Scale N.T.S.</td> <td>Scale N.T.S.</td> <td>Drawing No. SK - 03</td> </tr> </table> <p style="text-align: center;">Lapped over supported areas only.</p>	Product Boldroll. Ridge to Eaves Tile-Effect Sheet.	Title Dimensional Information.	Drawn by Second Base Limited	Date Jan 02	Scale N.T.S.	Scale N.T.S.	Scale N.T.S.	Drawing No. SK - 03	<table border="1" style="width: 100%; border-collapse: collapse;"> <tr> <td style="width: 25%;">Product Boldroll. Ridge to Eaves Tile-Effect Sheet.</td> <td style="width: 25%;">Title Dimensional Information.</td> <td style="width: 25%;">Drawn by Second Base Limited</td> <td style="width: 25%;">Date Jan 02</td> </tr> <tr> <td>Scale N.T.S.</td> <td>Scale N.T.S.</td> <td>Scale N.T.S.</td> <td>Drawing No. SK - 03</td> </tr> </table> <p style="text-align: center;">Lapped over supported areas only.</p>	Product Boldroll. Ridge to Eaves Tile-Effect Sheet.	Title Dimensional Information.	Drawn by Second Base Limited	Date Jan 02	Scale N.T.S.	Scale N.T.S.	Scale N.T.S.	Drawing No. SK - 03
Product Boldroll. Ridge to Eaves Tile-Effect Sheet.	Title Dimensional Information.	Drawn by Second Base Limited	Date Jan 02														
Scale N.T.S.	Scale N.T.S.	Scale N.T.S.	Drawing No. SK - 03														
Product Boldroll. Ridge to Eaves Tile-Effect Sheet.	Title Dimensional Information.	Drawn by Second Base Limited	Date Jan 02														
Scale N.T.S.	Scale N.T.S.	Scale N.T.S.	Drawing No. SK - 03														

LIGHTWEIGHT EAVE TO RIDGE TILE SHEET TECHNICAL INFORMATION

<p>UPSTAND FLASHING</p>  <p>DESCRIPTION: Upstand Flashing. LENGTH: 2000mm. GIRTH: 350mm. BENDS: 3 no.</p>	<p>MONO RIDGE FLASHING</p>  <p>To suit roof pitch.</p> <p>DESCRIPTION: Mono Ridge Flashing. LENGTH: 2000mm. GIRTH: 340mm. BENDS: 3 no.</p>	<p>JUNCTION FLASHING</p>  <p>DESCRIPTION: Junction Flashing. LENGTH: 2000mm. GIRTH: Variable. BENDS: 4 no.</p>	<p>VENT RIDGE</p>  <p>DESCRIPTION: Vent Ridge LENGTH: 1000mm. GIRTH: Variable. BENDS: 5 no.</p>
<p>EAVES FASCIA/SOFFIT</p>  <p>DESCRIPTION: 2 Piece Eaves Fascia/Soffit. Powder Coated/Smooth Finish. LENGTH: 2000mm. GIRTH: Variable. BENDS: 2 no.</p>	<p>VERGE FASCIA/SOFFIT</p>  <p>DESCRIPTION: 2 Piece Verge Fascia/Soffit. Powder Coated/Smooth Finish. LENGTH: 2000mm. GIRTH: Variable. BENDS: 2 no.</p>	<p>VALLEY FLASHING</p>  <p>To Suit Roof Pitch.</p> <p>DESCRIPTION: Valley Flashing LENGTH: 2000mm. GIRTH: 420mm. BENDS: 3 no.</p>	<p>VALLEY FLASHING</p>  <p>To Suit Roof Pitch.</p> <p>DESCRIPTION: Valley Flashing LENGTH: 2000mm. GIRTH: 420mm. BENDS: 3 no.</p>
<p>UPSTAND FLASHING</p>  <p>DESCRIPTION: Upstand Flashing. LENGTH: 2000mm. GIRTH: 350mm. BENDS: 3 no.</p>	<p>MONO RIDGE FLASHING</p>  <p>To suit roof pitch.</p> <p>DESCRIPTION: Mono Ridge Flashing. LENGTH: 2000mm. GIRTH: 340mm. BENDS: 3 no.</p>	<p>JUNCTION FLASHING</p>  <p>DESCRIPTION: Junction Flashing. LENGTH: 2000mm. GIRTH: Variable. BENDS: 4 no.</p>	<p>VENT RIDGE</p>  <p>DESCRIPTION: Vent Ridge LENGTH: 1000mm. GIRTH: Variable. BENDS: 5 no.</p>
<p>UPSTAND FLASHING</p>  <p>DESCRIPTION: Upstand Flashing. LENGTH: 2000mm. GIRTH: 350mm. BENDS: 3 no.</p>	<p>MONO RIDGE FLASHING</p>  <p>To suit roof pitch.</p> <p>DESCRIPTION: Mono Ridge Flashing. LENGTH: 2000mm. GIRTH: 340mm. BENDS: 3 no.</p>	<p>JUNCTION FLASHING</p>  <p>DESCRIPTION: Junction Flashing. LENGTH: 2000mm. GIRTH: Variable. BENDS: 4 no.</p>	<p>VENT RIDGE</p>  <p>DESCRIPTION: Vent Ridge LENGTH: 1000mm. GIRTH: Variable. BENDS: 5 no.</p>

LIGHTWEIGHT EAVE TO RIDGE TILE SHEET TECHNICAL INFORMATION

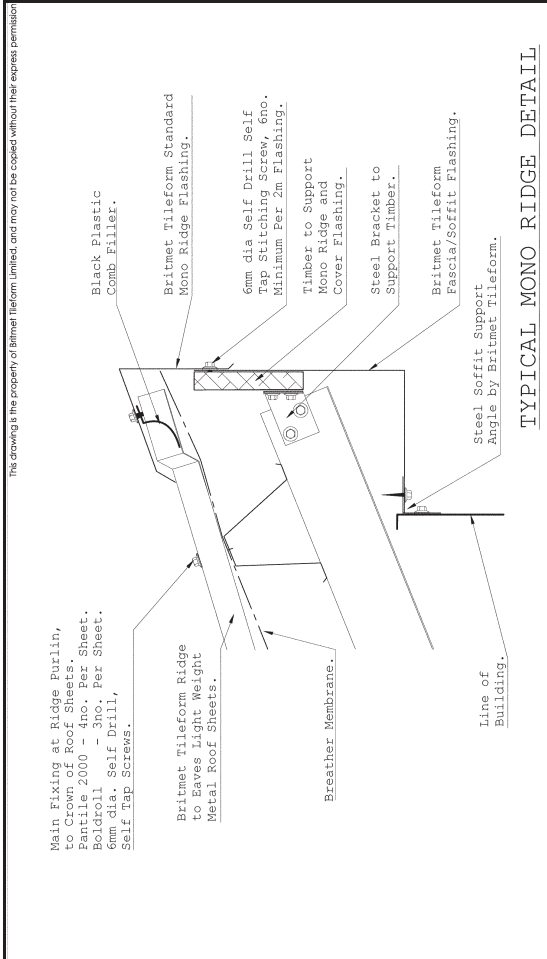

Product	Title	Drawn by	Date
Pantile 2000 / Boldroll. Ridge to Eaves Tile-Effect Sheet.	Typical Mono Ridge Detail. Steel Substructure.	Second Base Limited	Jan 02
		Scale	Drawing No.
		N.T.S.	SK - 14

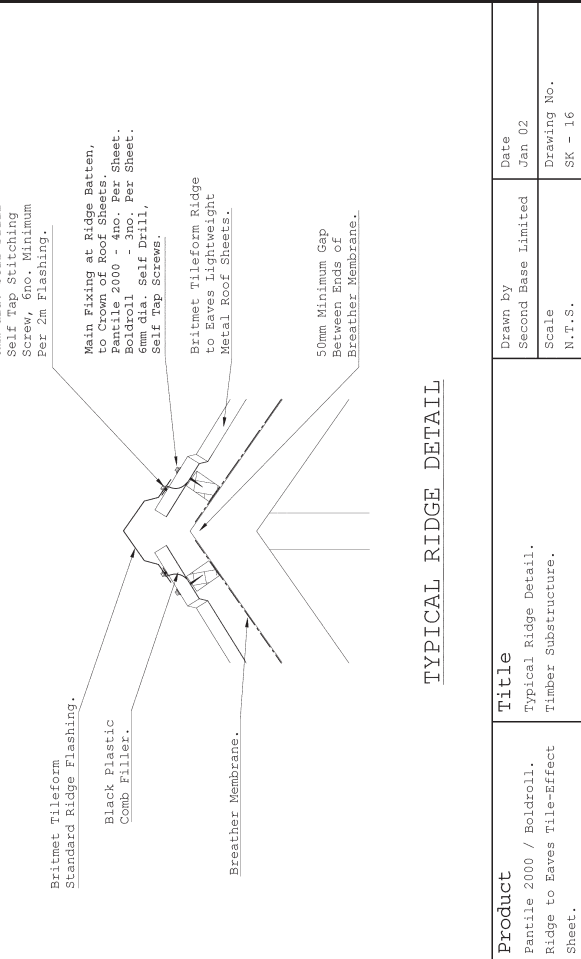

Product	Title	Drawn by	Date
Pantile 2000 / Boldroll. Ridge to Eaves Tile-Effect Sheet.	Typical Ridge Detail. Timber Substructure.	Second Base Limited	Jan 02
		Scale	Drawing No.
		N.T.S.	SK - 16

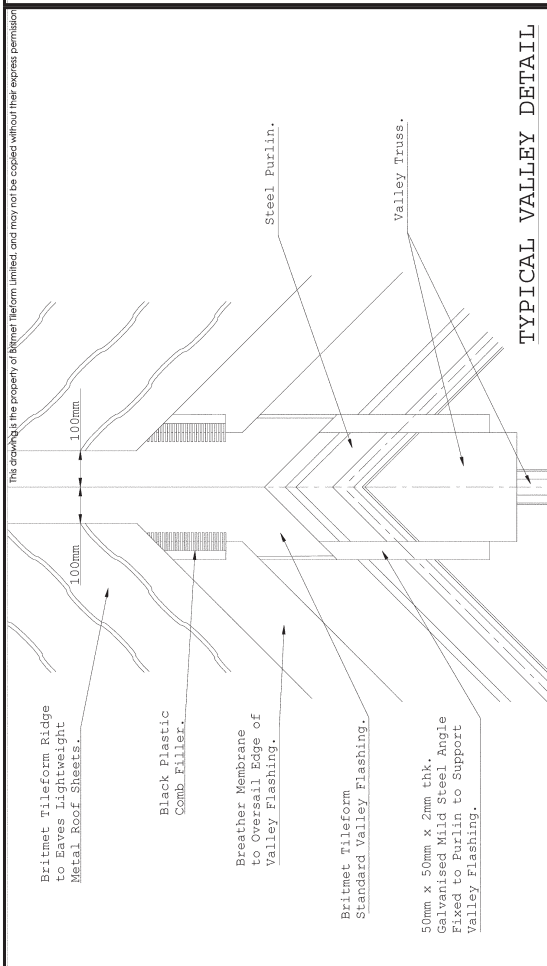

Product	Title	Drawn by	Date
Pantile 2000 / Boldroll. Ridge to Eaves Tile-Effect Sheet.	Typical Valley Detail. Steel Substructure. Cut Away Detail.	Second Base Limited	Jan 02
		Scale	Drawing No.
		N.T.S.	SK - 13

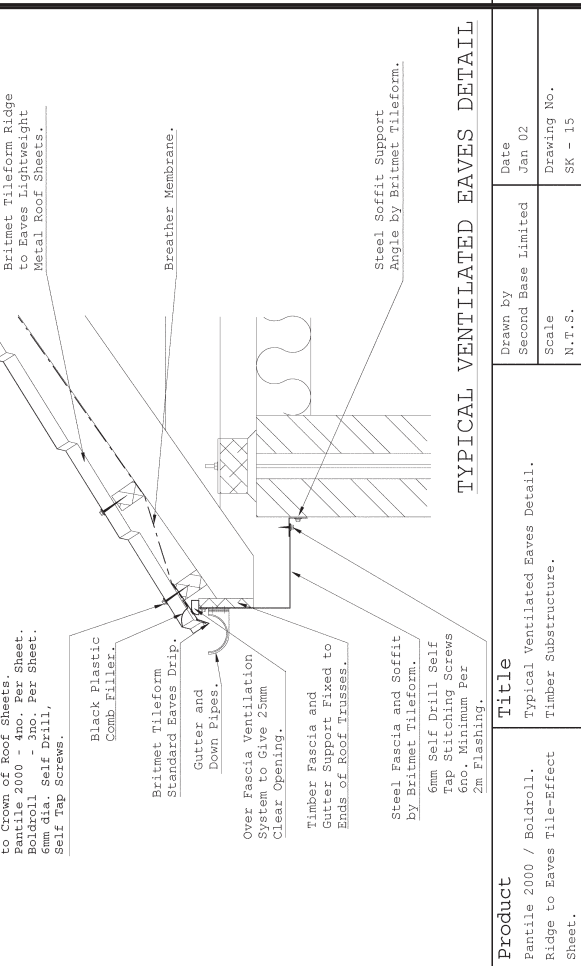

Product	Title	Drawn by	Date
Pantile 2000 / Boldroll. Ridge to Eaves Tile-Effect Sheet.	Typical Ventilated Eaves Detail. Timber Substructure.	Second Base Limited	Jan 02
		Scale	Drawing No.
		N.T.S.	SK - 15

LIGHTWEIGHT EAVE TO RIDGE TILE SHEET TECHNICAL INFORMATION

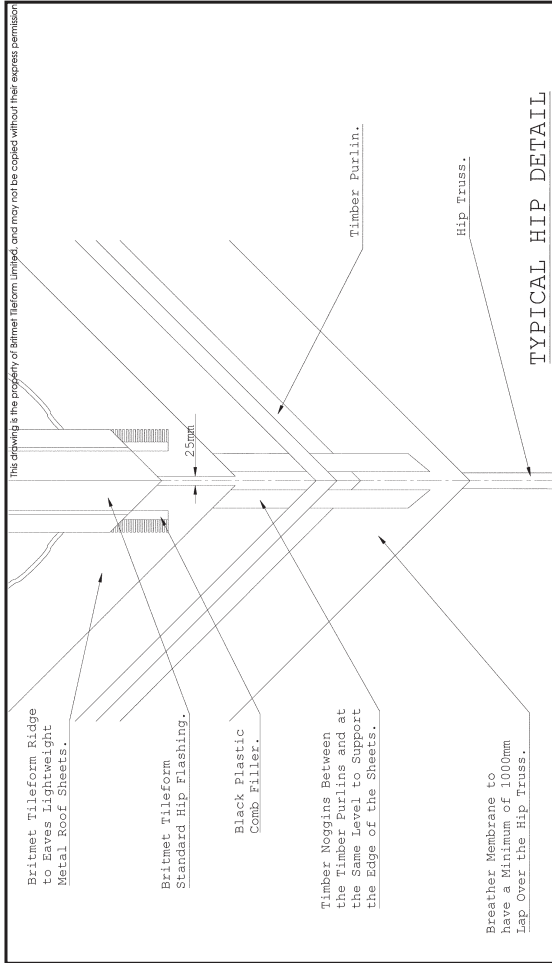

Product	Title	Drawn by	Date
Pantile 2000 / Boldroll. Ridge to Eaves Tile-Effect Sheet.	Typical Hip Detail. Timber Substructure. Cut Away Detail.	Second Base Limited	Jan 02
		Scale	Drawing No.
		N.T.S.	SK - 18

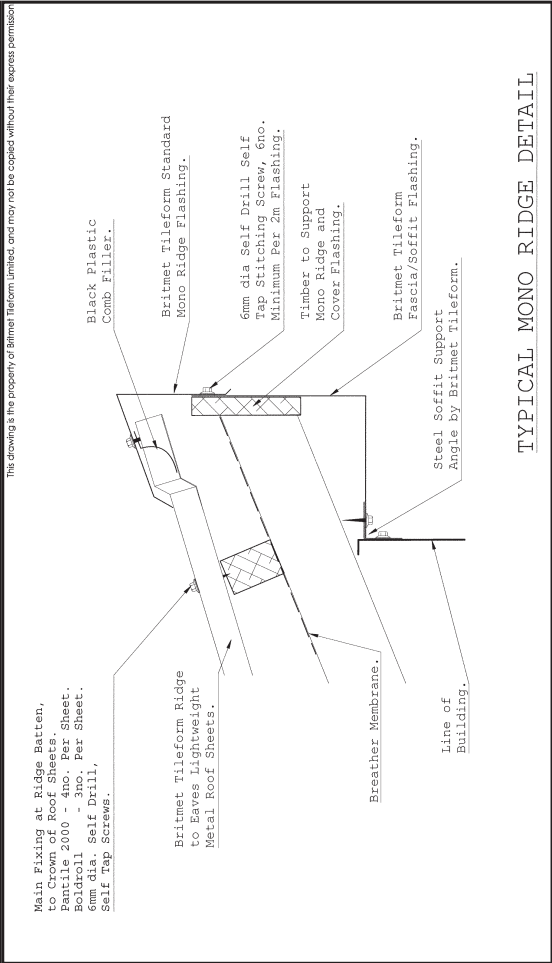

Product	Title	Drawn by	Date
Pantile 2000 / Boldroll. Ridge to Eaves Tile-Effect Sheet.	Typical Mono Ridge Detail. Timber Substructure. Cut Away Detail.	Second Base Limited	Jan 02
		Scale	Drawing No.
		N.T.S.	SK - 20

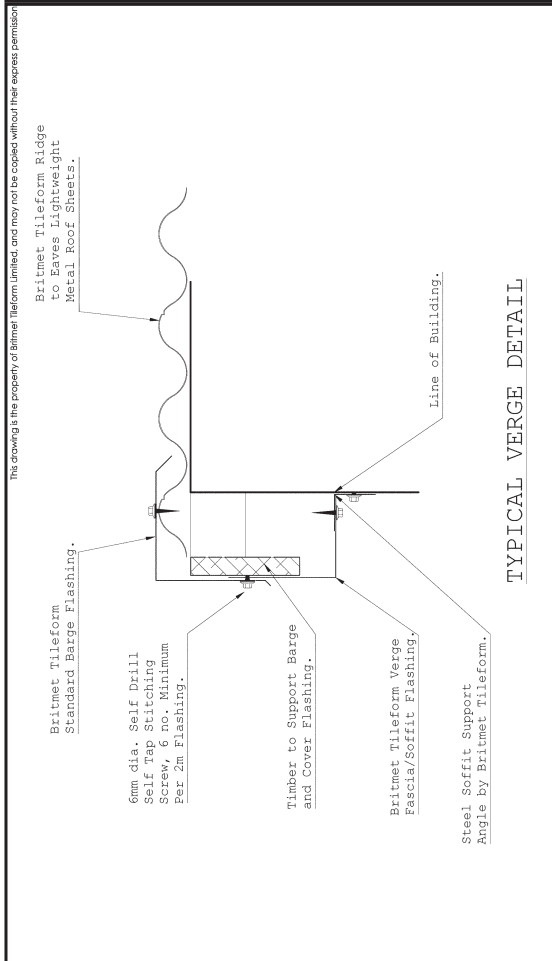

Product	Title	Drawn by	Date
Pantile 2000 / Boldroll. Ridge to Eaves Tile-Effect Sheet.	Typical Verge Detail. Timber Substructure.	Second Base Limited	Jan 02
		Scale	Drawing No.
		N.T.S.	SK - 17

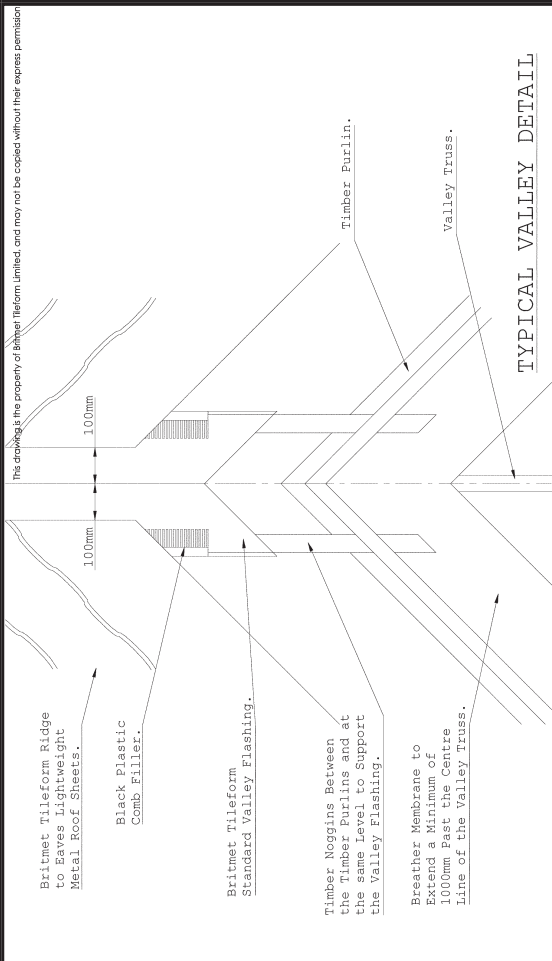

Product	Title	Drawn by	Date
Pantile 2000 / Boldroll. Ridge to Eaves Tile-Effect Sheet.	Typical Valley Detail. Timber Substructure. Cut Away Detail.	Second Base Limited	Jan 02
		Scale	Drawing No.
		N.T.S.	SK - 19

LIGHTWEIGHT EAVE TO RIDGE TILE SHEET TECHNICAL INFORMATION

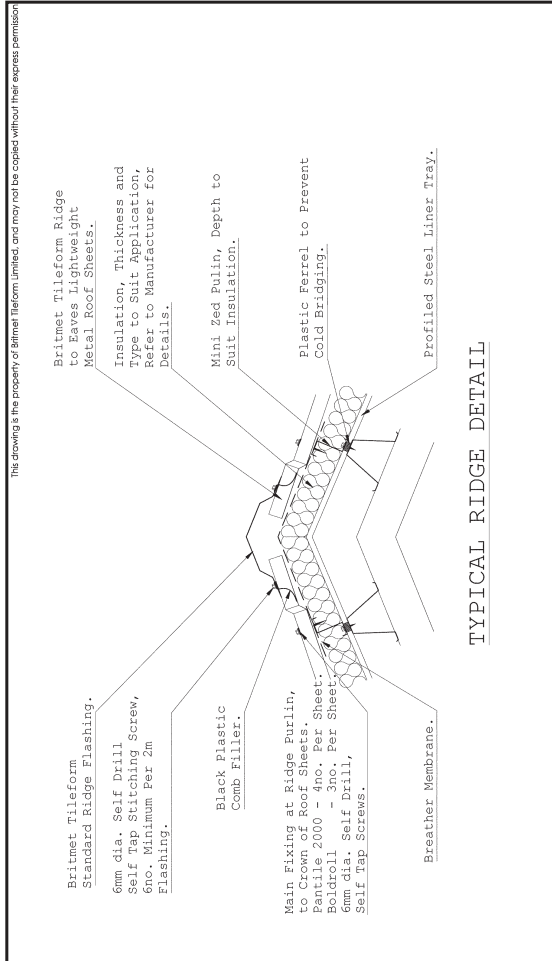

TYPICAL RIDGE DETAIL

Product Pantile 2000 / Boldroll. Ridge to Eaves Tile-Effect Sheet.	Title Typical Ridge Detail. Steel Substructure. Insulation and Liner Tray.	Drawn by Second Base Limited	Date Jan 02
		Scale N.T.S.	Drawing No. SK - 22

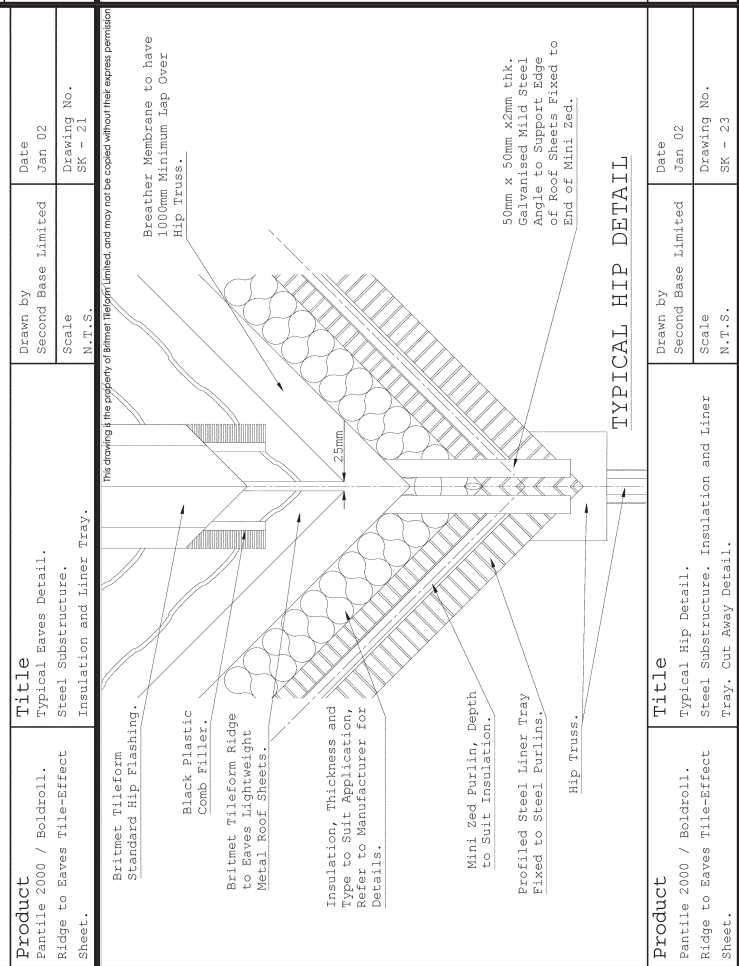

TYPICAL HIP DETAIL

Product Pantile 2000 / Boldroll. Ridge to Eaves Tile-Effect Sheet.	Title Typical Hip Detail. Steel Substructure. Insulation and Liner Tray. Cut Away Detail.	Drawn by Second Base Limited	Date Jan 02
		Scale N.T.S.	Drawing No. SK - 23

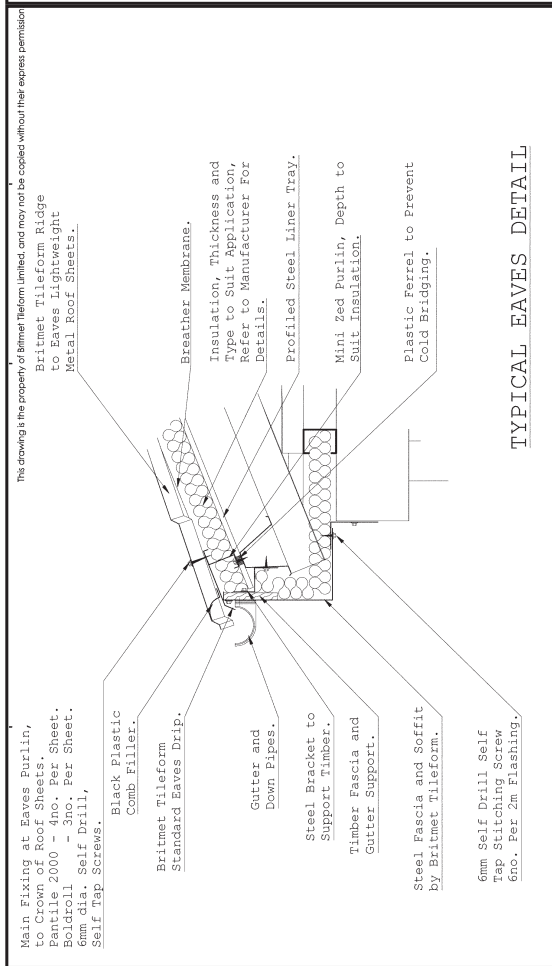

TYPICAL EAVES DETAIL

Product Pantile 2000 / Boldroll. Ridge to Eaves Tile-Effect Sheet.	Title Typical Eaves Detail. Steel Substructure. Insulation and Liner Tray.	Drawn by Second Base Limited	Date Jan 02
		Scale N.T.S.	Drawing No. SK - 21

Product Pantile 2000 / Boldroll. Ridge to Eaves Tile-Effect Sheet.	Title Typical Valley Detail. Steel Substructure. Insulation and Liner Tray. Cut Away Detail.	Drawn by Second Base Limited	Date Jan 02
		Scale N.T.S.	Drawing No. SK - 24

LIGHTWEIGHT EAVE TO RIDGE TILE SHEET TECHNICAL INFORMATION

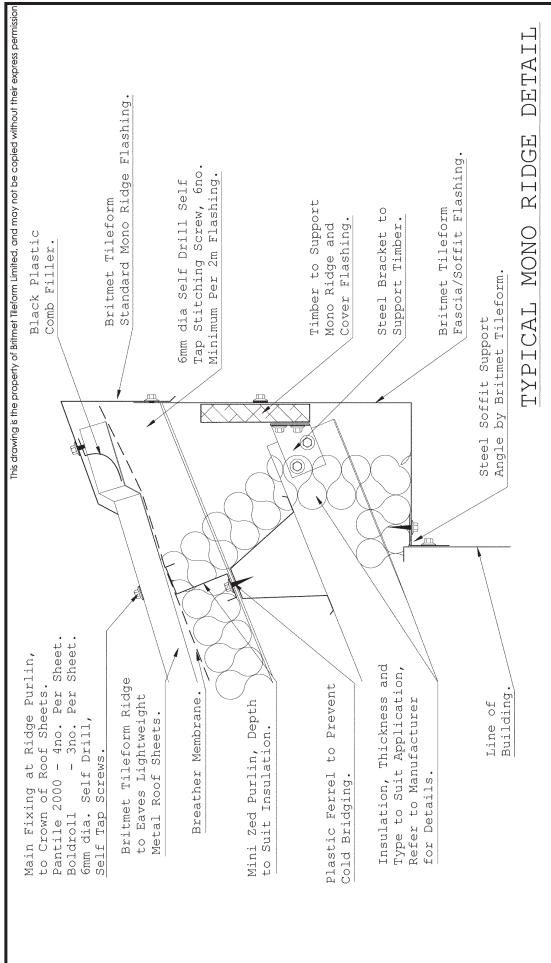

TYPICAL MONO RIDGE DETAIL	
Product Pantile 2000 / Boldroll. Ridge to Eaves Tile-Effect Sheet.	Title Typical Mono Ridge Detail. Steel Substructure. Insulation and Liner Tray.
Drawn by Second Base Limited	Date Jan 02
Scale N.T.S.	Drawing No. SK - 26

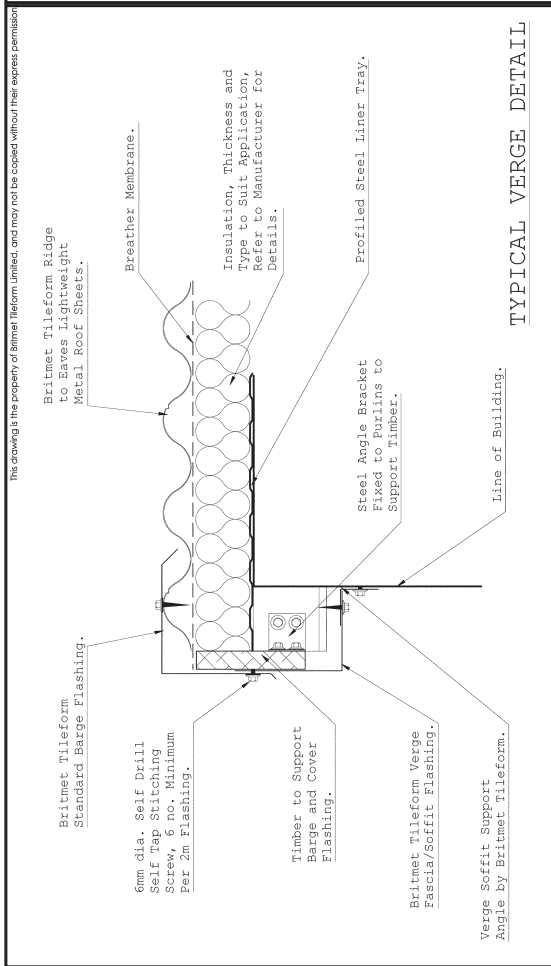
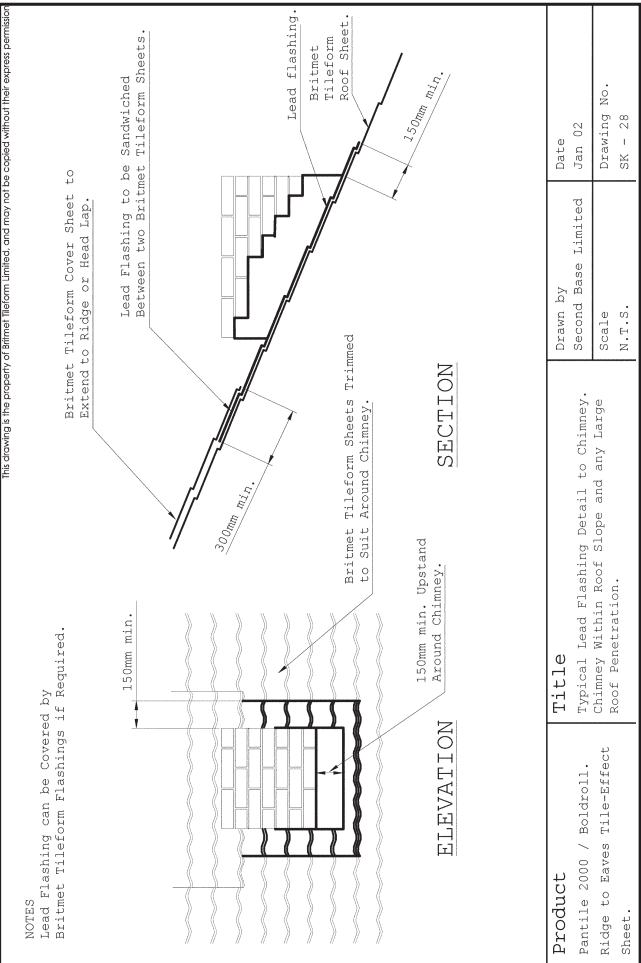

TYPICAL VERGE DETAIL	
Product Pantile 2000 / Boldroll. Ridge to Eaves Tile-Effect Sheet.	Title Typical Verge Detail. Steel Substructure. Insulation and Liner Tray.
Drawn by Second Base Limited	Date Jan 02
Scale N.T.S.	Drawing No. SK - 25

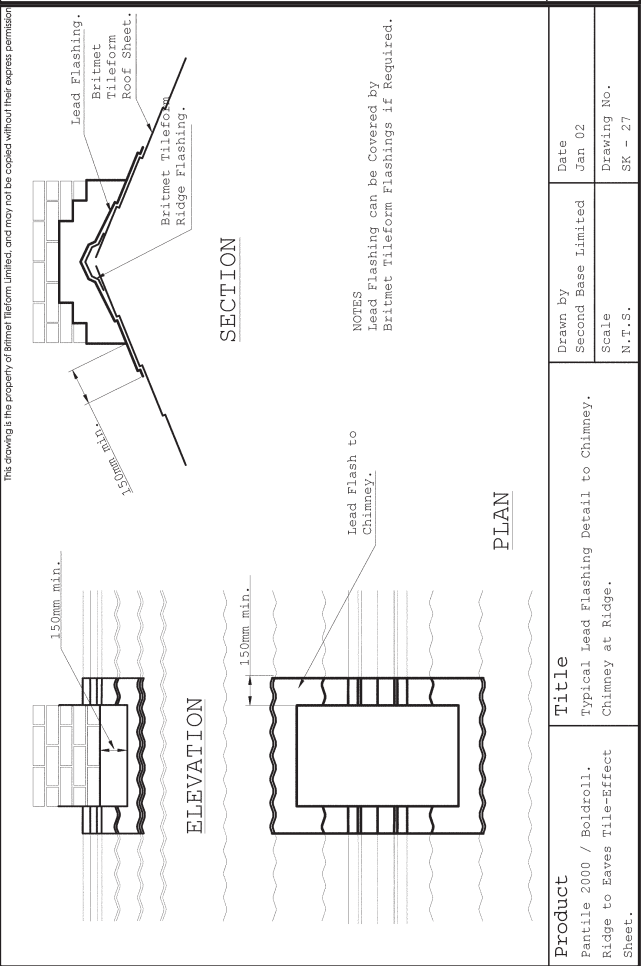

LIGHTWEIGHT EAVE TO RIDGE TILE SHEET TECHNICAL INFORMATION

The drawing is the property of Bimmet Tileform Limited, and may not be copied without their express permission.

Note
Britmet Tileform Flashings Can be Used Instead of Lead Flashings or in Conjunction with Lead Flashings Dependant on Application.

6mm dia Screw, 3no. Minimum Per 2m Flashing, Type to Suit Make Up of Wall.

Britmet Tileform Standard Upstand Flashing.

6mm dia Self Drill Self Tap Stitching Screws, 3no. Per Flashing.

25mm Deep by 3mm Wide Saw Cut to Wall, Filled With Mastic Sealant Prior to the Insertion of the Upstand Flashing.

Line of Building

Britmet Tileform Ridge to Eaves Lightweight Metal Roof Sheets.

Timber Rafter Fixed to Wall to Support Edge of Sheet.

Breather Membrane.

TYPICAL UPSTAND FLASHING DETAIL

Product Pantile 2000 / Boldroll. Ridge to Eaves Tile-Effect Sheet.	Title Typical Upstand Flashing Detail.	Drawn by Second Base Limited	Date Jan 02
		Scale N.T.S.	Drawing No. SK - 30

The drawing is the property of Bimmet Tileform Limited, and may not be copied without their express permission.

Note
Britmet Tileform Flashings Can be Used Instead of Lead Flashings or in Conjunction with Lead Flashings Dependant on Application.

6mm dia Screw, 3no. Minimum Per 2m Flashing, Type to Suit Make Up of Existing Building.

Britmet Tileform Standard Apron Flashing.

6mm dia Self Drill Self Tap Stitching Screws, 3no. Per Flashing.

25mm Deep by 3mm Wide Saw Cut to Building, Filled With Mastic Sealant Prior to the Insertion of the Apron Flashing.

Line of Building

Britmet Tileform Ridge to Eaves Lightweight Metal Roof Sheets.

Black Plastic Comb Filler.

Timber Batten Fixed to Existing Wall to Support Edge of Sheet.

Breather Membrane.

TYPICAL APRON FLASHING DETAIL

Product Pantile 2000 / Boldroll. Ridge to Eaves Tile-Effect Sheet.	Title Typical Apron Flashing Detail.	Drawn by Second Base Limited	Date Jan 02
		Scale N.T.S.	Drawing No. SK - 29

The drawing is the property of Bimmet Tileform Limited, and may not be copied without their express permission.

Note
Head Laps to be, 300mm Minimum
Ridge to Eaves Lightweight Metal Roof Sheets.
Fitch < 10 Degrees, 75mm Minimum
Fitch > 10 Degrees.

15mm dia Mastic Sealing Bead Compressed Between Tileform Roof Sheet and Translucent Sheet.

6mm dia Self Drill Self Tap Stitching Screw @ 900 mm Centres

Translucent Sheet, Showing Extent of Laps.

Right Hand Sheet.

Left Hand Sheet.

Bottom Sheet.

Top Sheet.

Ridge.

Eaves.

Side Lap.

Translucent Sheet.

PLAN

SECTION

TYPICAL UPSTAND FLASHING DETAIL

Product Pantile 2000 / Boldroll. Ridge to Eaves Tile-Effect Sheet.	Title Typical Detail at Translucent Sheet, Plan and Section.	Drawn by Second Base Limited	Date Jan 02
		Scale N.T.S.	Drawing No. SK - 32

The drawing is the property of Bimmet Tileform Limited, and may not be copied without their express permission.

Note
Main Fixing to Batten, to Crown of Roof Sheets, Pantile 2000 - 3no. Per Sheet.
Boldroll - 2no. Per Sheet.
6mm dia. Self Drill, Self Tap Screws.

Britmet Tileform Ridge to Eaves Lightweight Metal Roof Sheets.

Breather Membrane to be Continuous Over Joint.

Lead Flashing Recommended for Pitch < 15 Degrees.

Main Fixing to Batten, to Crown of Roof Sheets, Pantile 2000 - 3no. Per Sheet.
Boldroll - 2no. Per Sheet.
6mm dia. Self Drill, Self Tap Screws.

TYPICAL DETAIL AT CHANGE IN SLOPE

Product Pantile 2000 / Boldroll. Ridge to Eaves Tile-Effect Sheet.	Title Typical Detail at Change in Slope.	Drawn by Second Base Limited	Date Jan 02
		Scale N.T.S.	Drawing No. SK - 31

LIGHTWEIGHT EAVE TO RIDGE TILE SHEET TECHNICAL INFORMATION

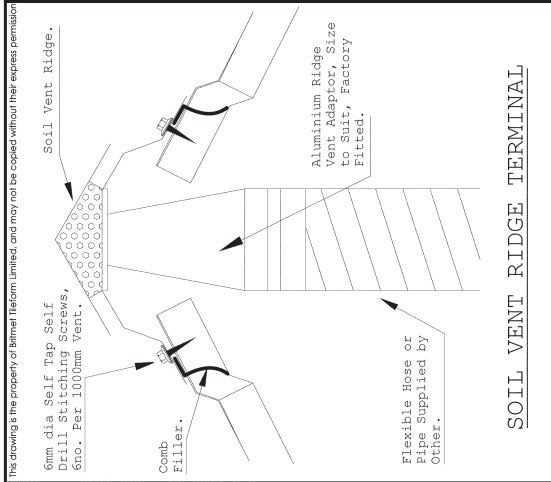

SOIL VENT RIDGE TERMINAL

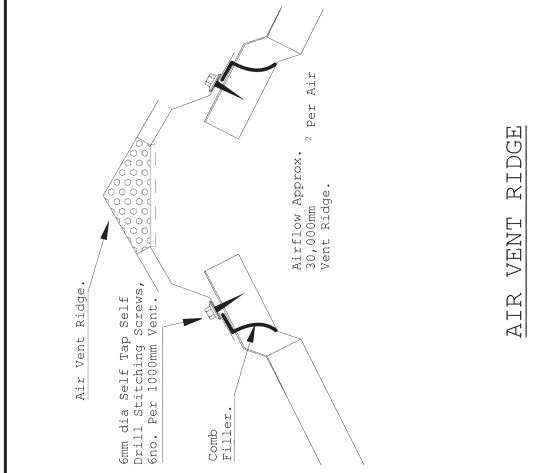

AIR VENT RIDGE

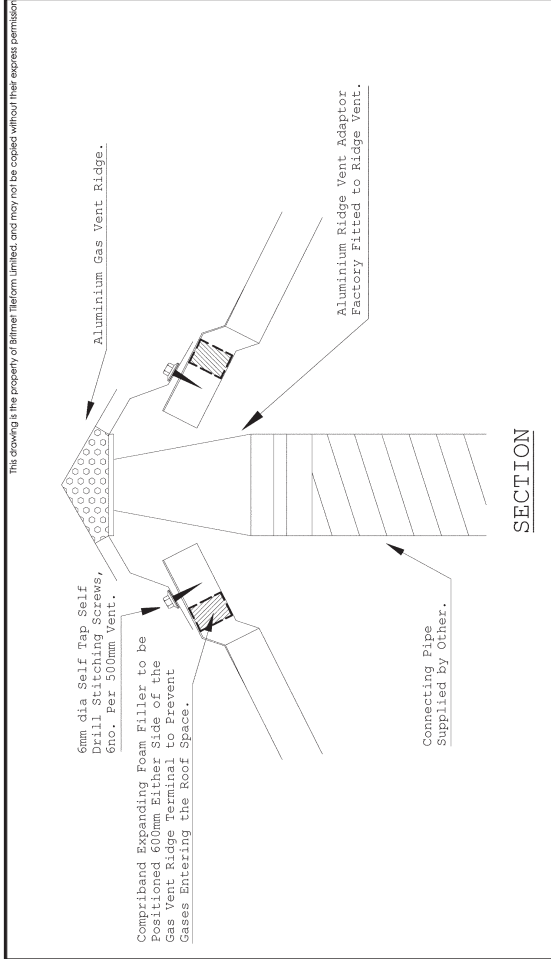

SECTION

Product Pantile 2000 / Boldroll. Ridge to Eaves Tile-Effect Sheet.	Title Typical Aluminium Gas Vent Ridge Detail.	Drawn by Second Base Limited Scale N.T.S.	Date Jan 02 Drawing No. SK - 33
Product Pantile 2000 / Boldroll. Ridge to Eaves Tile-Effect Sheet.	Title Typical Air Vent Ridge and Soil Vent Ridge Terminal Detail.	Drawn by Second Base Limited Scale N.T.S.	Date Jan 02 Drawing No. SK - 34

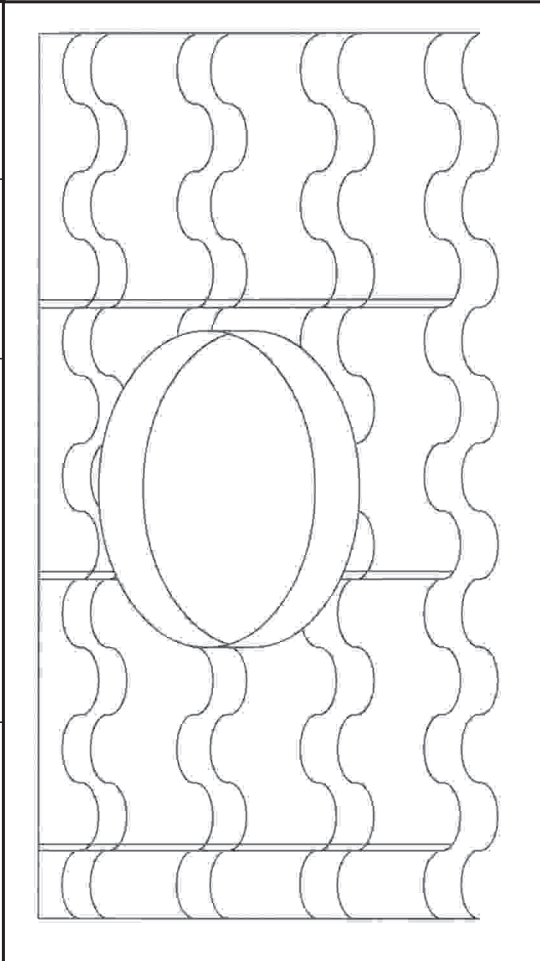

Product Pantile 2000 / Boldroll. Ridge to Eaves Tile-Effect Sheet.	Title Typical Detail at a Box Gutter.	Drawn by Second Base Limited Scale N.T.S.	Date Jan 02 Drawing No. SK - 35
Product Pantile 2000 / Boldroll. Ridge to Eaves Tile-Effect Sheet.	Title Sunpipe/Roof Light Penetration Size to Suit	Drawn by Britmet Tileform Scale N.T.S.	Date June 06 Drawing No. SK - 36

We reserve the right, at any time in our sole discretion, to: modify, suspend or discontinue these products without notice. For this reason, we encourage you to check with our technical team to confirm sizes, products, before purchase/install.

Manufacturers of light weight roofing systems

Britmet Tileform Ltd, Spital Farm Offices, Thorpe Mead, Banbury, Oxon OX16 4RZ

Tel: 01295 250998 Fax: 01295 271068

www.britmet.co.uk

email: sales@britmet.co.uk