

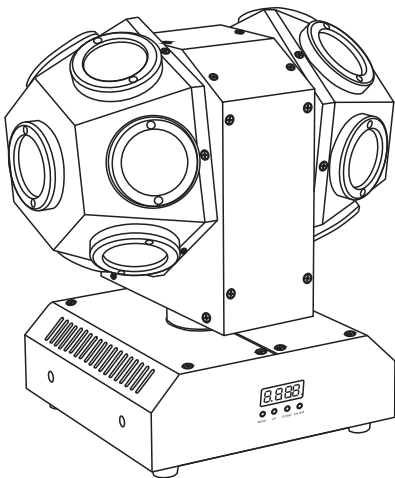

OPPSK

Double Beam LED

Moving Head Light



User Manual

At first, thank you for purchasing the device. For the sake of safety and regular operation of this projector, please read this manual carefully before using and operating it in order to avoid any personal injury or damage to the device.

@2023 OPPSK all rights reserved. Information, specifications, diagrams, images, and instructions herein are subject to change without notice. OPPSK logo and identifying product names and numbers herein are trademarks of OPPSK. Copyright protection claimed includes all forms and matters of copyrightable materials and information now allowed by statutory or judicial law or hereinafter granted. Product names used in this document may be trademarks or registered trademarks of their respective companies and are hereby acknowledged. All non-OPPSK brands and product names are trademarks or registered trademarks of their respective companies.

OPPSK and all affiliated companies hereby disclaim any and all liabilities for property, equipment, building, and electrical damages, injuries to any persons, and direct or indirect economic loss associated with the use or reliance of any information contained within this document, and/or as a result of the improper, unsafe, insufficient and negligent assembly, installation, rigging, and operation of this product.

Europe Energy Saving Notice

Energy Saving Matters(EuP 2009/125/EC)

Saving electric energy is a key to help protecting the environment. Please turn off all electrical products when they are not in use. To avoid power consumption in idle mode, disconnect all electrical equipment from power when not in use. Thank you!

Warning! To prevent or reduce the risk of electrical shock or fire, do not expose this unit to rain or moisture.

Caution! There are no user serviceable parts inside this unit. Do not attempt any repairs yourself, as doing so will void your manufacturer's warranty. In the unlikely event that your unit requires service, please contact OPPSK.

Customer Support: OPPSK provides a customer support line to provide set up help and to answer any question that may arise during your set up or initial operation. You may also contact us for any comments or suggestions. Service Hours are Monday through Saturday 9:00 a.m. to 6:00 p.m. Pacific Standard Time.

E-mail: hyt-amz-sale@outlook.com

PLEASE recycle the shipping carton when ever possible.

INTRODUCTION

Unpacking: Thank you for purchasing the moving head lights by OPPSK. Every moving head lights have been thoroughly tested and has been shipped in perfect operating condition. Carefully check the shipping carton for damage that may have occurred during shipping. If the carton appears to be damaged, carefully inspect your fixture for any damage and be sure all accessories necessary to operate the unit have arrived intact. In the event that damage has been found or parts are missing, please contact our toll free customer support number for further instructions. Do not return this unit to your dealer without first contacting customer support.

Introduction: The moving head lights are a DMX intelligent, LED fixture. This fixture can be used in a stand alone mode or connected in a primary/secondary configuration. The operating modes are as follows: Sound Active mode, Auto mode, Strobe Mode and DMX control mode, Master/Slave Mode.

What is included: 1.Moving Head Light 2.DMX Cable 3.Power Cable 4.Safety Cable 5.Bracket 6.Screws 7.Instruction Manual

Fixture Appearance & Size:

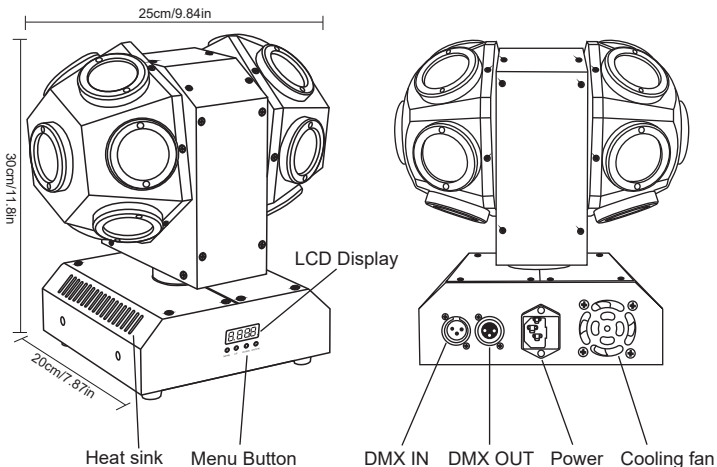

Orientation: The moving head light can be mounted in any position, however, make sure adequate ventilation is provided around the product.

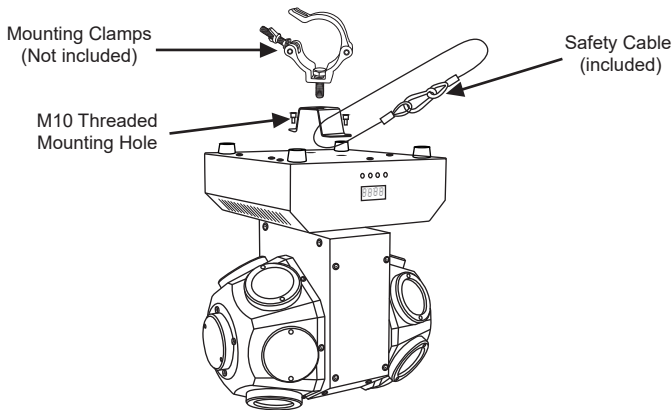

INSTALLATION

The unit should be mounted using a mounting clamp (not provided), affixing it to the mounting bracket that is provided with the unit. Always ensure that the unit is firmly fixed to avoid vibration and slippage while operating. Always ensure that the structure to which you are attaching the unit is secure. Always ensure that the structure to which you are attaching the unit is secure and is able to support a weight of 10 times the unit's weight. Also, always use a safety cable that can hold 12 times the weight of the unit when installing the fixture. The equipment must be installed by a professional, and it must be installed in a place where it is out of the reach of people's grasp.

WARRANTY REGISTRATION

The moving head light carries a 1 year limited warranty. All returned service items, whether under warranty or not, please provide a brief description of the problem also be written down on a piece of paper by yourself included in the shipping carton. If the unit is under warranty, please provide order ID of purchase. You may contact our customer support team on our customer support number and email.

SAFETY PRECAUTIONS

- To reduce the risk of electrical shock or fire, do not expose this unit to rain or moisture.
- Do not spill water or other liquids into or on to your unit.
- Do not attempt to operate this unit if the power cord has been frayed or broken.
- Do not attempt to remove or break off the ground prong from the electrical cord. This prong is used to reduce the risk of electrical shock and fire in case of an internal short.
- Disconnect from main power before making any type of connection.
- Do not remove the cover for any reason. There are no user serviceable parts inside.
- Never operate this unit with the cover removed.
- Never plug this unit in to a dimmer pack.
- Always be sure to mount this unit in an area that will allow proper ventilation.
- Do not attempt to operate this unit if it has been damaged in any way.
- This unit is intended for indoor use only. Use of this product outdoors voids all warranties.
- During long periods of non-use, disconnect the unit's main power.
- Always mount this unit in a safe and stable matter.
- Power supply cords should be routed so that they are not likely to be walked on or pinched by items placed upon or against them, paying particular attention to the point at which they exit from the unit.
- Cleaning - The fixture should be cleaned only as recommended by the manufacturer. The cleaning of internal and external optical lenses and/or mirrors must be carried out periodically to optimize light output. Clean with soft cloth using normal glass cleaning fluid. Always dry the parts carefully. Cleaning frequency depends on the environment in which the fixture operates: damp, smoky or particularly dirty surrounding can cause greater accumulation of dirt on the unit's optics.
- Heat - The appliance should be situated away from heat sources, such as radiators, heat registers, stoves, or other appliances (including amplifiers) that produce heat.
- The fixture should be serviced by qualified service personnel when:
 - A. The power supply cord or the plug has been damaged.
 - B. Objects have fallen onto, or liquid has been spilled into, the appliance.
 - C. The appliance has been exposed to rain or water.
 - D. The appliance does not appear to operate normally or exhibits a marked change in performance.

SET UP

Power Supply: The moving head light supports wide voltage, which voltage range of 100 to 240 VAC, 50/60 Hz, no need to worry about the correct power voltage, and this unit can be plugged in anywhere.

DMX-512: DMX is short for Digital Multiplex. This is a universal protocol used by most lighting and controller manufactures as a form of communication between intelligent fixtures and controllers. A DMX controller sends DMX data instructions from the controller to the fixture. DMX data is sent as serial data that travels from fixture to fixture via the DATA "IN" and DATA "OUT" XLR terminals located on all DMX fixtures.

DMX Linking: DMX is a language allowing all makes and models of different manufacturers to be linked together and operate from a single controller, as long as all fixtures and the controller are DMX compliant. To ensure proper DMX data transmission, try to use the shortest cable path possible when linking several DMX fixtures. The order in which fixtures are connected in a DMX line does not influence the DMX addressing. For example, a fixture assigned a DMX address of 1 may be placed anywhere in a DMX line: at the beginning, at the end, or anywhere in the middle. When a fixture is assigned a DMX address of 1, the DMX controller knows to send DATA assigned to address 1 to that unit, no matter where it is located in the DMX chain.

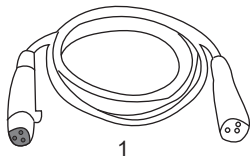

Data Cable (DMX Cable) Requirements (For DMX and Master/Slave Operation):

The moving head light can be controlled via DMX protocol. Your unit and your DMX controller require a approved DMX-512 110 Ohm Data cable (3-pin DMX signal cable equipped) for data input and data output (Picture 1). Your cables should be made with a male XLR connector at one end of the cable and a female XLR connector at the other.

SYSTEM MENU

Control Panel Operation



















Operation Instructions: After startign press A(MENU) Enter into main-menu, Press B(UP) C(DOWN) to select the submenu, and then press D(ENTER) ensure.







LCD Digital Display



MENU: function mode , such as DMX address & channel, Master-slave mode, sound activated & sensitivity adjustment.
DOWN/UP: previous or next, increase or decrease
Enter: confirm and save the selection

Digital Display Table

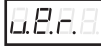
Button	Display		Description
Menu			Set DMX address code A001
			
		Select the number of channels	
			
		Set Master-slave 1/2 mode	
			
			
		Auto effect show 1-9	
	...		
			
		Sound mode 1/2	
			
		Sound Sensitivity Adjustment (weak to strong)	
			

			Display on/off
			
			Display setting
			Software version
			Reset

OPERATING INSTRUCTIONS

DMX Control:

This function allows you to use a universal DMX-512 controller to control the chases, color, speed, movement, dimmer and strobe. A DMX controller allows you to create unique programs tailored to your individual needs.

1. The product has 2 DMX Channel modes; 6 Channels, & 12 Channels. Follow the instructions of Digital Display Table to select your desired DMX channel number and to set the DMX address.
2. To control and operate your fixture in DMX mode, follow the set-up procedures of DMX channel table.
3. This will allow you to create your own programs.
4. For longer cable runs (more than a 100 feet) use a terminator on the last fixture.

DMX Connection:

Set the product in DMX mode/A001 to control with a DMX controller.

- Connect the product to a suitable power outlet
- Connect a DMX cable from the DMX output of the DMX controller to the DMX input socket on the product.

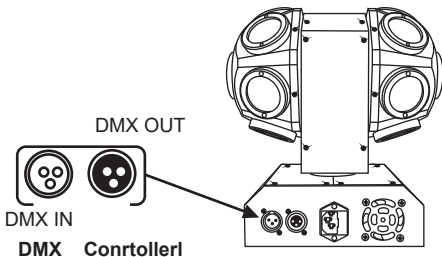

Sound Active Mode: In this mode the moving head light will react to sound, and chase through the different colors.

1. Press the MENU button until "SoUn" is displayed, press ENTER.
2. The display will show either "SoUn 1" or "SoUn 2". Press the UP or DOWN buttons to select it.
3. Press ENTER to confirm.

Master-Slave Mode: This function will allow you to link up to 50 units together and operate without a controller. In a Master-Slave set up one unit will act as the controlling unit and the others will react to the controlling units programs. Any unit can act as a Master or as a Slave.

1. For the Master unit press the MENU button until "SLnd" is displayed, and press ENTER. The display will show either "nRSt", "SL 1" or "SL 2". Press the UP or DOWN buttons to select "nRSt" and press ENTER.
2. Next set the Master to your desired operating mode.
3. For the slave units press the MENU button until "SLnd" is displayed, and Press ENTER. The display will show either "nRSt", "SL 1" or "SL 2". Press the UP or DOWN buttons to select "SL 1" or "SL 2" and press ENTER.
4. The slave units will now follow the Master unit.

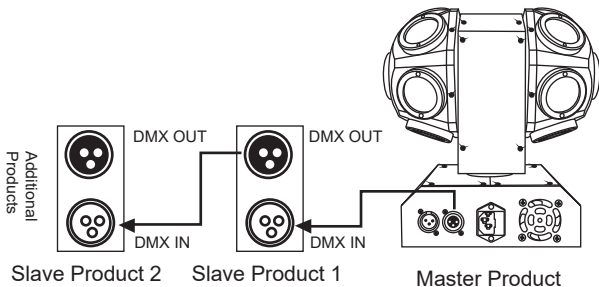

DMX Channel Table

6 Channel Mode		
Channel	Funcio	Value
1	Dimmer	000-255 0%~100%
2	Strobe	000-007 Open 008-255 Stroboscope (Speed 0- 100%)
3	Movement	000-007 No function 008-022 Movement 01 (Tilt1,2-Positive rotation) 023-037 Movement 02 (Tilt1,2-Reverse rotation) 038-052 Movement 03 (Tilt2-Reverse rotation) 053-067 Movement 04 (Tilt1,2-Positive, Reverse rotation) 068-082 Movement 05 (Tilt1,2-Positive, Reverse rotation) 083-097 Movement 06 (Tilt1-Reverse rotation) 098-112 Movement 07 (Tilt1,2-Positive rotation) 113-127 Movement 08 (Tilt2-Reverse rotation) 128-142 Movement 09 (Tilt1,2-Positive, Reverse rotation) 143-157 Movement 10 (Tilt1,2-Positive, Reverse rotation) 158-172 Movement 11 (Tilt1,2-Reverse, Positive rotation) 173-187 Movement 12 (Tilt1,2-Positive, Reverse rotation) 188-202 Movement 13 (Tilt1,2-Positive rotation) 203-217 Movement 14 (Tilt2-Reverse rotation) 218-232 Movement 15 (Tilt2-Reverse rotation) 233-247 Movement 16 (Tilt1,2-Reverse, Positive rotation) 248-255 Sound active
4	Movement Speed	000-255 Movement Speed slow to fast
5	Color Chase	000-015 No Function 015-035 chase 1 036-056 chase 2 057-076 chase 3 078-097 chase 4 098-117 chase 5 118-138 chase 6 139-159 chase 7 160-179 chase 8 180-200 chase 9 201-220 chase 10 221-241 chase 11 242-255 chase 12
6	Chase Speed	000-255 Chase Speed slow to fast

12 Channel Mode		
Channel	Funcio	Value
1	Dimmer	000-255 0%~100%
2	Strobe	000-007 Open
		008- 255 Stroboscope (Speed 0 - 100%)
3	Pan	000-255 Pan 0°~ 360°
4	Pan speed	000-255 Speed fast to slow
5	Pan Rotate	000-005 Stop
		006-126 Movement forward fast -> slow
		127-128 Stop
		129-249 Movement forward Slow > Fast
		250-255 Stop
6	Tilt1	000-255 Tilt1 0°~ 360°
7	Tilt1 Rotate	000-005 Stop
		006-126 Movement forward fast -> slow
		127-128 Stop
		129-249 Movement forward Slow > Fast
		250-255 Stop
8	Color1	000 - 007 Blackout
		008-024 R
		025-041 G
		042-057 B
		058-074 W
		075-090 R + G
		091-107 R+B
		108-123 R+W
		124- 140 G + B
		141-156 G+W
		157-173 B+W
		174-189 R +G + B
		190-206 R +G + W
		207-222 R+B+W
223-239 G+B+W		
240-255 R+G+B+W		
9	Tilt2	000- 255 Tilt2 0°~ 360°
10	Tilt2 Rotate	000-005 Stop
		006-126 Movement forward fast -> slow
		127-128 Stop

		129-249 Movement forward Slow -> Fast
		250-255 Stop
11	Color2	000-255 See Color 1 Value
12	Chase Speed	000 - 255 Chase Speed slow to fast

SPECIFICATIONS

Model:	Double Beam LED Moving Head Light
Voltage:	AC110-240V,50/60Hz
LEDs:	14pcs*10W RGBW 4IN1 CREE
Working Position:	Any safe working position
Power Draw:	150W
Weight:	14.3lb
Dimensions:	13.8x10.6x14.6 in
Beam angle:	6°
Pan Tilt movement:	x-axis: infinite tilt , Y-axis: infinite tilt
Dimmer:	0-100% linear dimming
Strobe:	Electric strobe,0.3-25 times second
Operation:	Auto,DMX512,Sound,Master/Slave
DMX Channels:	6/12-Channel DMX Mode
Warranty:	1 Year (365 Days)
Control:	DMX

Please Note: Specifications and improvements in the design of this unit and this manual are subject to change without any prior written notice.

OPPSK

Voice: +86-137-9853-9318

Email: hyt-amz-sale@outlook.com

Amazon Store: Website: www.oppsk.com