

## **INSTALLATION GUIDE: AWE C7 CORVETTE TRACK OR TOURING EXHAUST**

For up-to-date fitment information, please visit the product page on [AWE-Tuning.com](https://www.awe-tuning.com).

### **THIS GUIDE IS INTENDED FOR THE FOLLOWING PART NUMBERS:**

- 3020-42073 AWE Track Edition Axle-back Exhaust for C7 Corvette - Chrome Silver Tips
- 3020-43081 AWE Track Edition Axle-back Exhaust for C7 Corvette - Diamond Black Tips
- 3015-42133 AWE Touring Edition Axle-back Exhaust for C7 Corvette - Chrome Silver Tips
- 3015-43143 AWE Touring Edition Axle-back Exhaust for C7 Corvette - Diamond Black Tips

Welcome to the AWE family, and congratulations on your purchase of the AWE Exhaust System for the C7 Corvette.

Exquisite build quality and craftsmanship, coupled with industry leading performance, distinguish this exhaust system from all others.

\*For up to the minute fitment information, be sure to visit the AWE website. As always, AWE Performance Specialists are standing by for any questions, [right here](#).

# PARTS LIST



INSPECT ALL PARTS PRIOR TO DISASSEMBLY OF VEHICLE; CONFIRM NO PARTS ARE DAMAGED OR MISSING, PLEASE CONTACT THE PLACE OF PURCHASE IMMEDIATELY IF ANY ISSUES.

## Axle-Back Exhaust

QTY	Description	Part Number
1	C7 Corvette DS axle tube	B85
1	C7 Corvette PS axle tube	B86
2	3.00in Accu-Seal clamps	180300
4	M8-1.25 x 25mm socket head cap bolt	91292A148
4	M8-1.25 locknut	94920A500
4	4.5in exhaust tip Chrome Silver	180014
4	4.5in exhaust tip Diamond Black	180015
4	AWE Tip clamp hardware kit	3910-41010
1	Heat-reflective wrap-around sleeving	2627K33 - cut to length
1	C7 Corvette rear center plate	110032
6	Cable ties	7130K59
2	C7 valve sim bracket	110073

### Touring System Only

1	C7 Corvette DS Touring rear section	B87
1	C7 Corvette PS Touring rear section	B88

### Track System Only

1	C7 Corvette DS Track rear section	B89
1	C7 Corvette PS Track rear section	B90

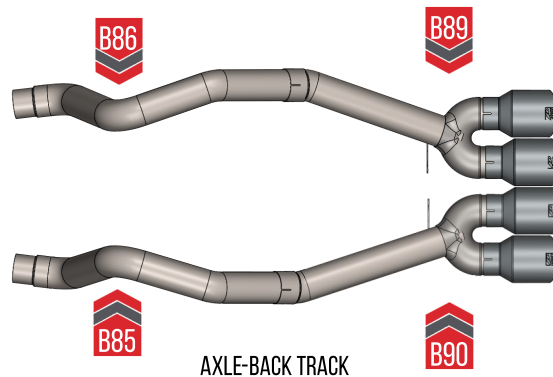
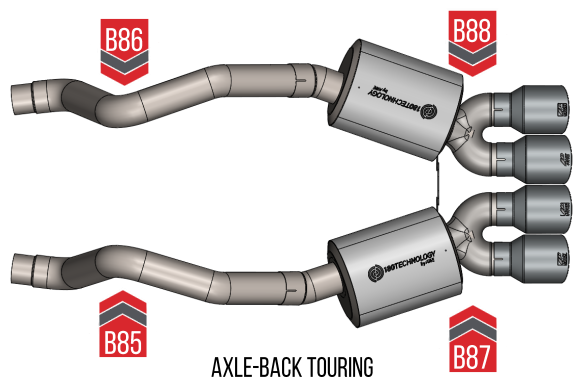



**NOTE:** Always refer to the manufacturer's service manual for precise torque specifications on all OEM fasteners.



**CAUTION:** The exhaust may be **VERY HOT** — allow adequate time for the system to cool down before disassembly. Severe burns and injury will occur if skin comes into contact with a hot exhaust system.

## STEP 1

Installation of the **AWE Axle Back** exhaust system is the reverse of the OEM exhaust removal.

Start by removing the rear bumper valance by removing the license plate, to access to the two bolts shown in **Figure 1**.



## STEP 2

Remove the two bolts above the exhaust tip outlets, shown in **Figure 2**.

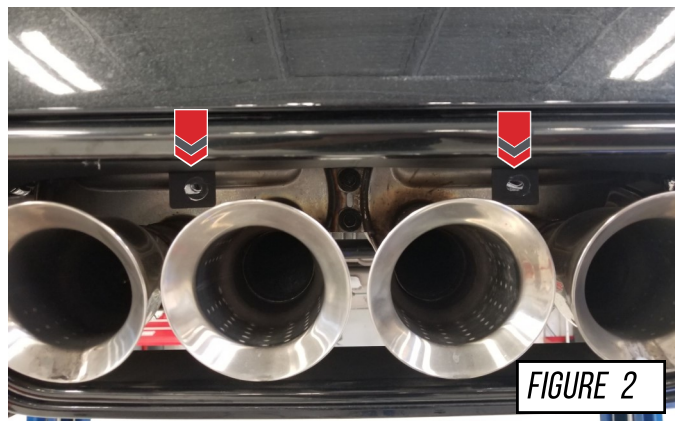

## STEP 3

Remove the 5 per side screw, shown as **(A)** 10 screws total, found along the bottom of the rear valance, leave the 1 screw per side, shown as **(B)**.



## STEP 4

Remove the driver and passenger side plastic grill inserts by pushing them out from the inside. These are held into place with 6 clips shown in **Figure 4**.



You may use painters tap to protect the paint, but is not required.



FIGURE 4

## STEP 5

Remove the two rear reflectors shown in **Figure 5-1** by pushing them out from the inside of the bumper. Each one is held in with 3 clips.



FIGURE 5-1

With the reflectors out of the way, you now have access to 4 bolts, two on each side to be removed shown in **Figure 5-2**.



FIGURE 5-2

## STEP 6

Remove the rear valance from the car, this is done by unclipping the top corners and carefully pulling the part away from the car.

## STEP 7

For **Non-NPP** exhaust skip this step.

For NPP vehicles, unplug the driver and passenger side rear valve harness wires from the valve motor, shown in **Figure 7**. This can be accomplished by disengaging the grey lock tab and squeezing the harness plug.

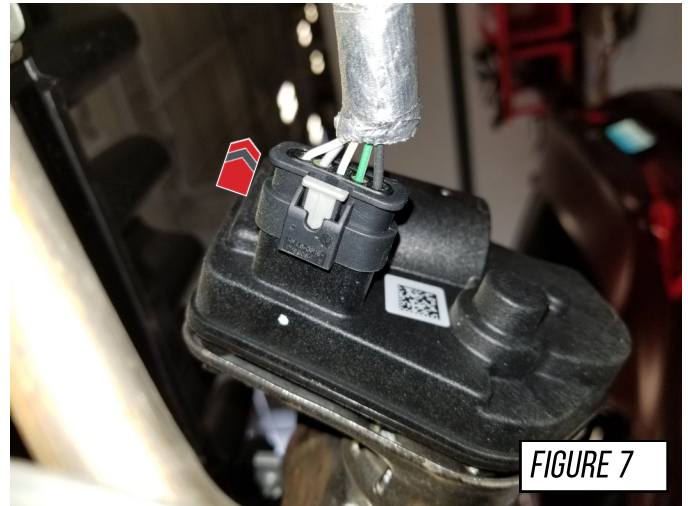

## STEP 8

Remove the two bolts holding the rear mufflers together, as shown in **Figure 8-1**.

Detach the rear muffler hanger, by removing the two bolts from each side shown in **Figure 8-2**.



Save these hanger bracket bolts as they will be used when installing the new exhaust.

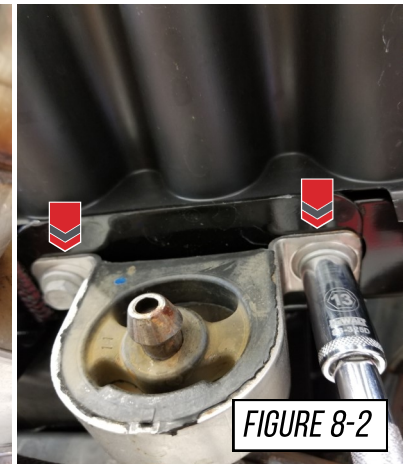

## STEP 9

For **Manual** vehicles skip this step.

**Automatic** vehicles ONLY:

To remove the driver side exhaust tube, you need to shift the vehicle into neutral. This will allow enough space around the shift linkage on the transmission for the exhaust tube to slide out, as shown in **Figure 9**.

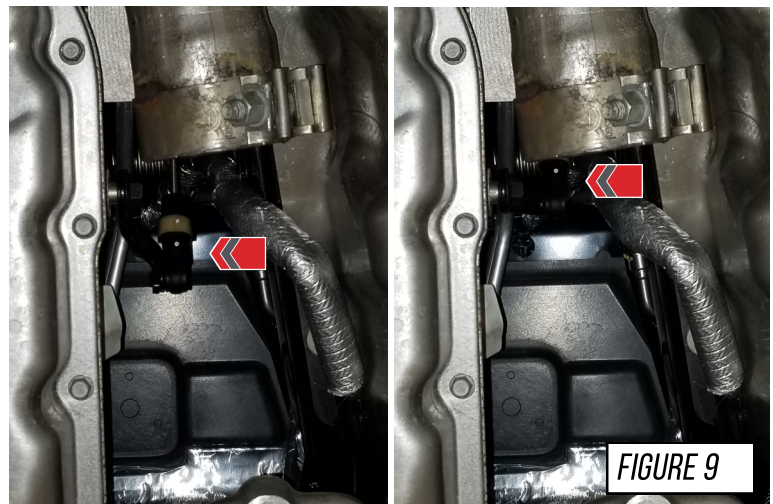

## STEP 10

Loosen the driver and passenger clamp bolts, shown in **Figure 10**. This will allow you to remove both rear sections of the exhaust.

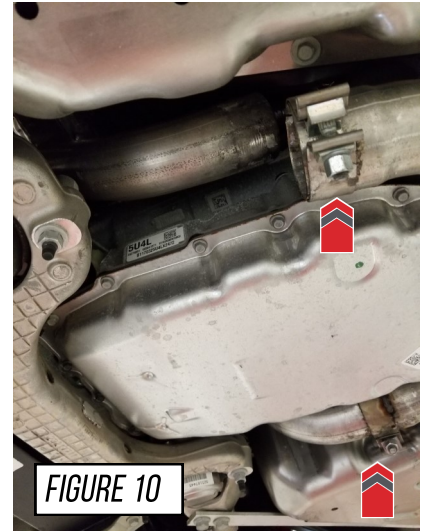

## STEP 11

Pivot the driver and passenger side exhaust tubes down from the rear of the vehicle and remove as shown in **Figure 11**.



The exhaust mount on the rear section will need to be removed and reused during the installation of your new exhaust.

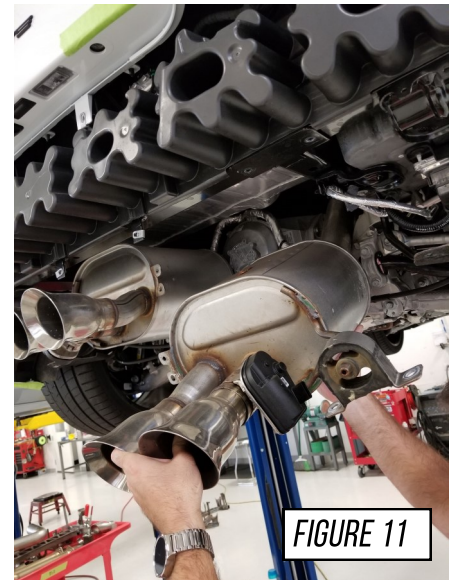

## STEP 12

**Non-NPP** vehicles skip this step.

With all components removed, secure the NPP valve harness to the chassis, with cable ties, as seen in **Figure 12**.



## STEP 13

Cut the supplied 10in section of heat wrap in half, as shown in Figure 13-1. Use the heat wrap to cover the braided sections of **DRIVER SIDE** transmission lines shown in **Figure 13-1**. With the heat shield on, use the supplied zip ties to ensure the line is secured out of the way.

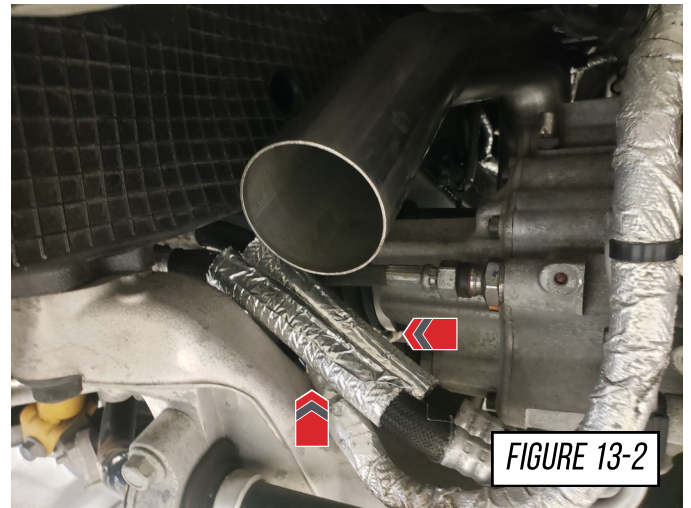
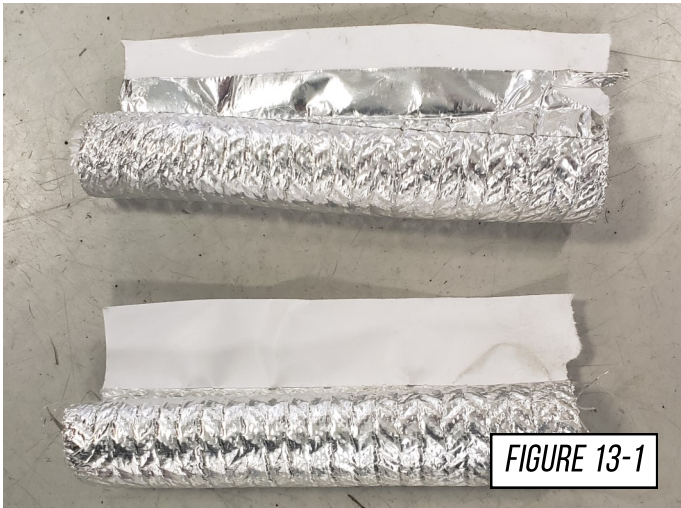

**STEP 14 IS FOR CARS WITH AFM VALVES. IF YOUR CAR DOES NOT HAVE AFM VALVES SKIP TO STEP 15.**



## STEP 14



**AFM cars REQUIRE** the AFM simulators.

Locate and remove the AFM valve motors from the OE exhaust.

**Note:** You will reuse the OE bolts, to attach the valve motor to the AWE bracket.

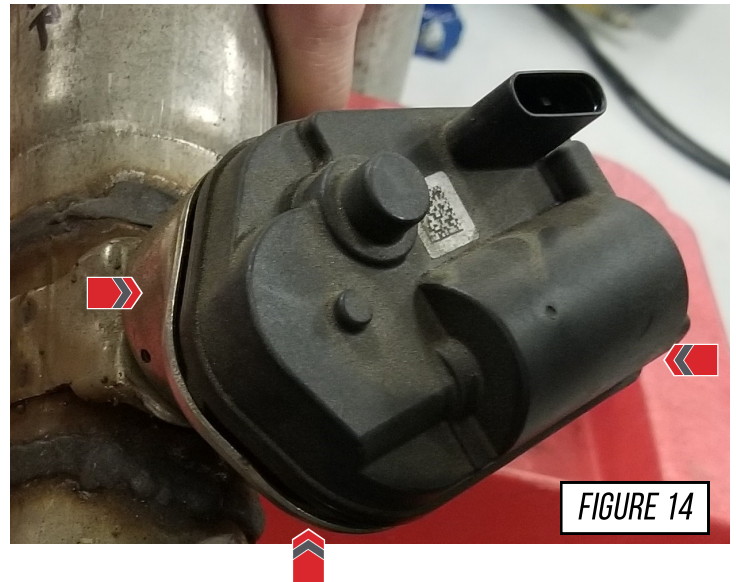

## STEP 15

You will need to flip the OE valve motor arm for proper operation.

To do this remove the 1 torx bolt in the center of the arm, as shown in by the arrow in **Figure 15-1**.

Next flip the OE valve arm over, as shown in **Figure 15-2** and reinstall the OE torx bolt.

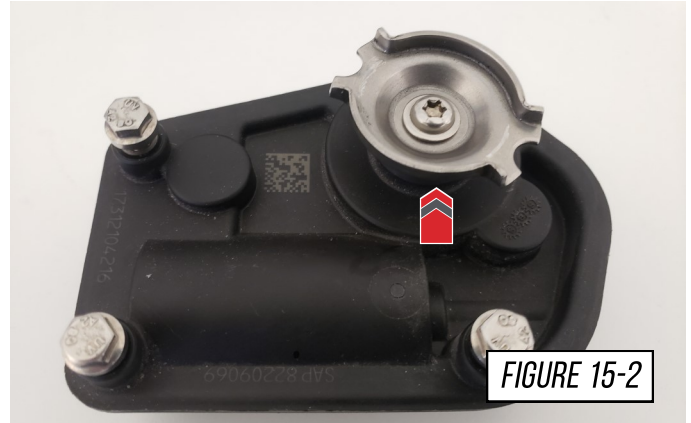
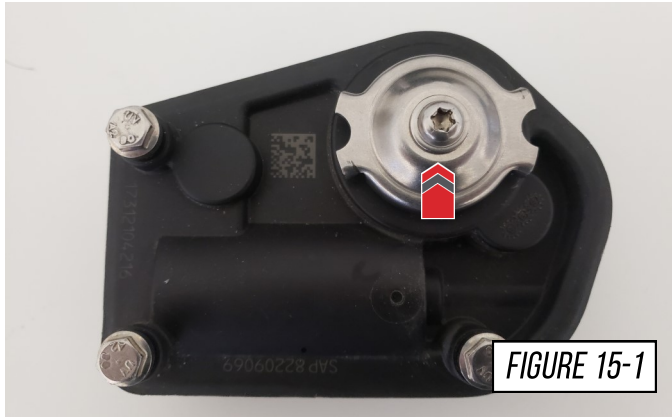

## STEP 16

Using the OE bolts removed earlier, attach your AWE C7 AFM Disabler to the OE valve motor, as shown in **Figure 16**.

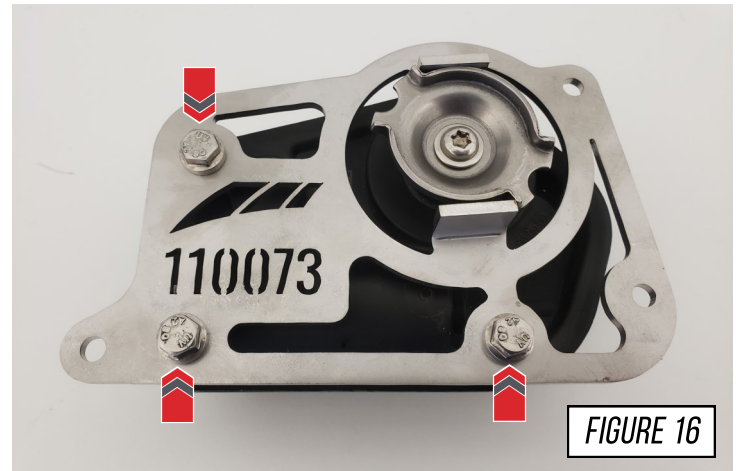

## STEP 17

Safely secure the valve disabler assembly to the vehicle using the supplied cable ties.



Make sure to mount the assembly away from any moving parts or high temperature areas.

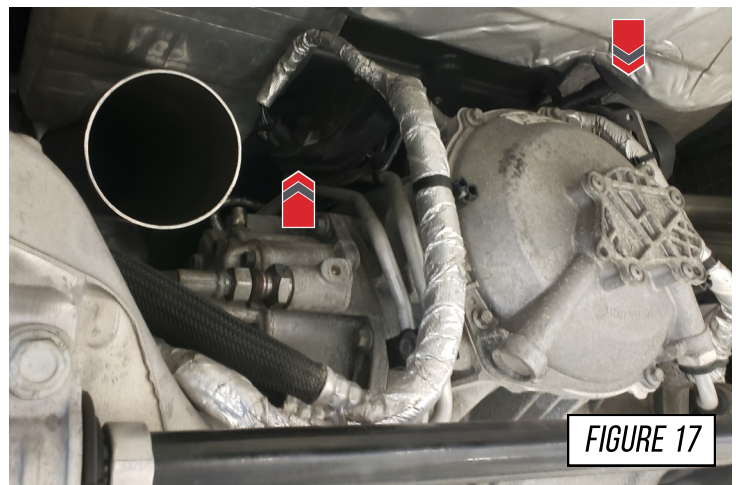



## STEP 18

Install the two over axle tubes from the rear of the vehicle (A), following the same way the OE system was removed and connecting to the X pipe (B), shown in **Figure 18**.

Ensure you install the driver and passenger tube on the correct side.

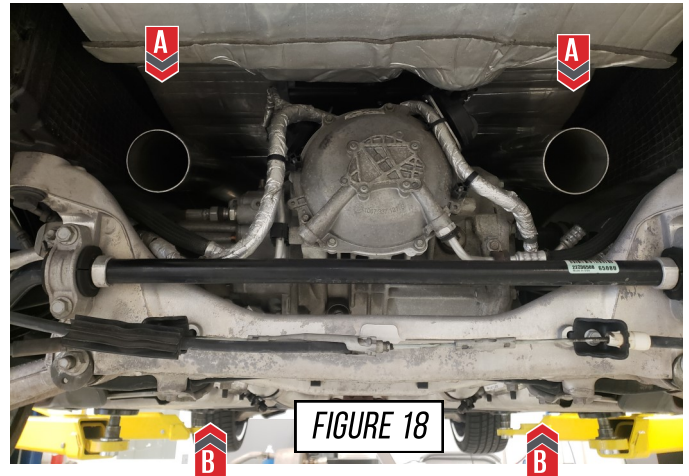

## STEP 19

Install the factory rear hangers (B) and the Accu-Seal clamps onto your AWE driver and passenger side rear sections of the exhaust (A), as seen in **Figure 19**.

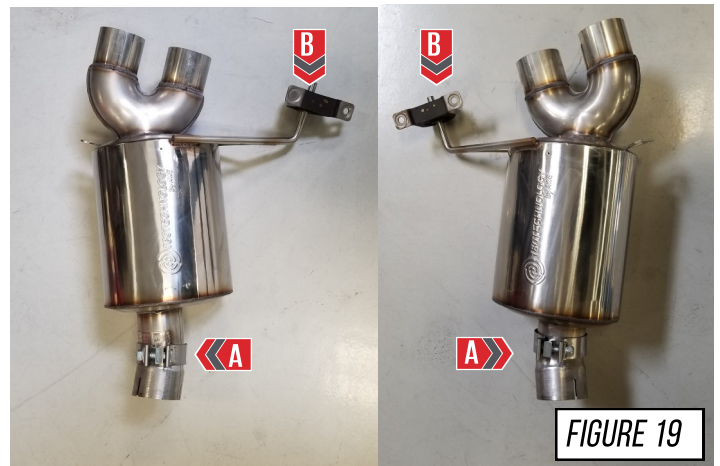

## STEP 20

It is crucial to install each section and Accu-Seal clamp correctly to prevent loose joints, exhaust leaks between the tubing connections and rattles.

**Arrow A** in **Figure 20** shows the expanded pipe and the preinstalled Accu-Seal clamp being brought up to the corresponding pipe.

**Arrow B** in **Figure 20** shows the overlapping pipe installed correctly over the corresponding pipe.

**Arrow C** in **Figure 20** shows the Accu-Seal clamp being brought to the edge of the expanded pipe.

### NOTES:



- **Do not** torque any Accu-Seal clamp until the entire exhaust has been installed and adjusted.
- Torque specification is a minimum of 60 ft/lbs

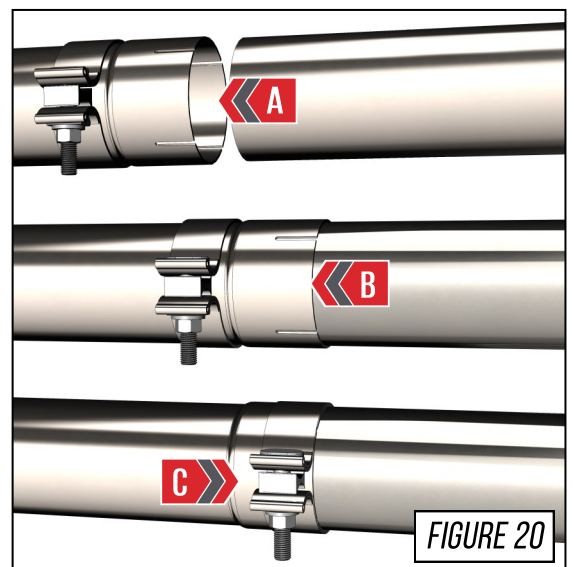

## STEP 21

Install the rear driver and passenger sections onto the over axle tube, ensure the slip joint is fully pressed together as seen in **Figure 21-1**, and **Figure 21-2**. Hand tighten the Accu-seal clamps.

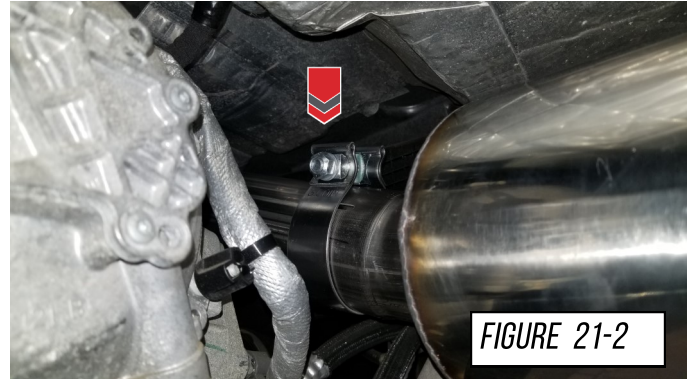
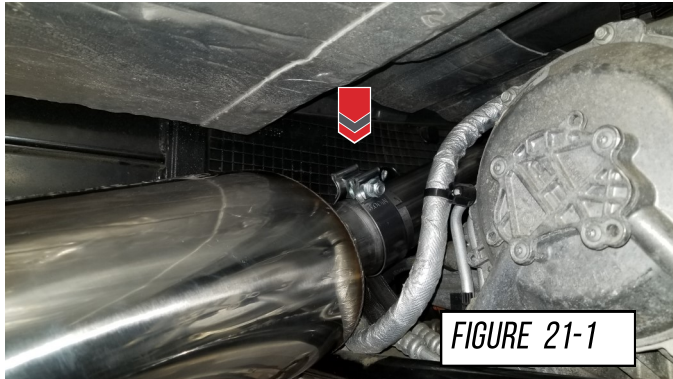

## STEP 22

With the rear sections of the exhaust in place, use the factory hardware you removed earlier to reinstall the rear hangers, as shown in **Figure 22**.

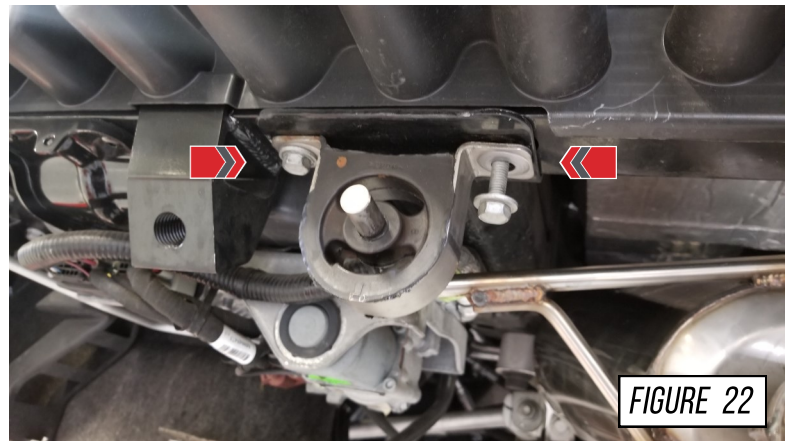

## STEP 23

With both rear sections in place as shown in **Figure 23-1**, gather the AWE exhaust plate and provided hardware to bolt together the driver and passenger side section with the plate installed towards the rear of the vehicle as shown in **Figure 23-2**.



Hand tighten all bolts first to allow for correct alignment.

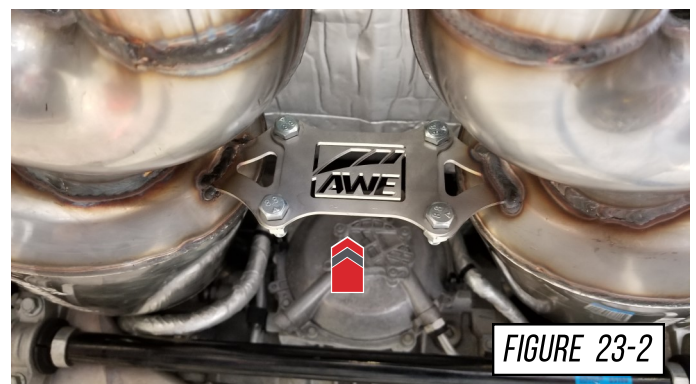
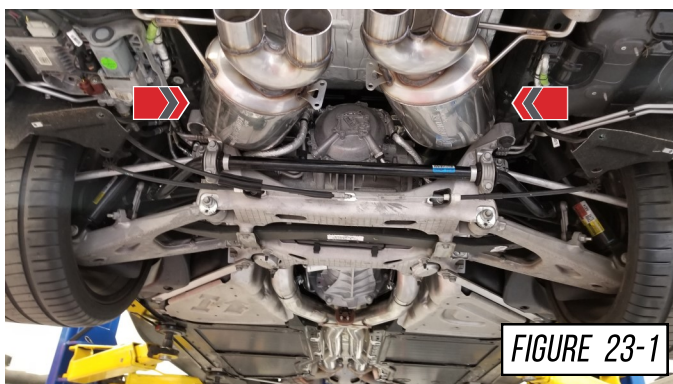

## STEP 24

As mentioned in **step 21** and **step 23**, prior to this step all joints and clamps should be snug but not fully tightened down.

Make sure to adjust the orientation of the system so that the exhaust tubes have plenty of clearance from any parts of the chassis, braces, and heat shields. Once the system is oriented correctly, tighten down the clamps as shown in **Figure 24**.



**NOTE:** To ensure your perfect fitment, take your time to adjust your system properly

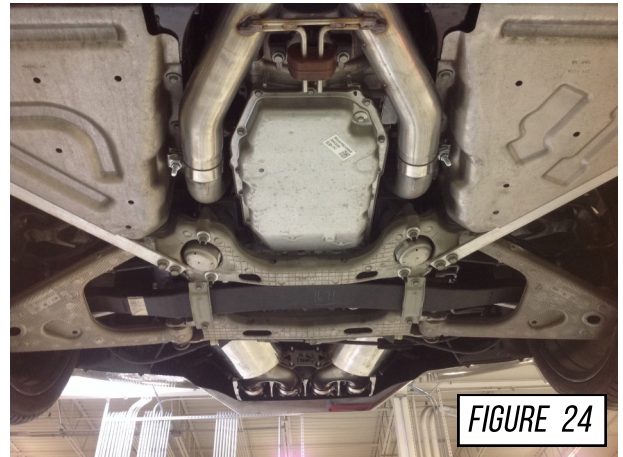

## STEP 25

Now reinstall the rear bumper sections, this process is the opposite of **step 1** through **step 6**.



Be careful not to scratch the paint on the body.

## STEP 26



Make sure to apply anti-seize on all barrel clamp bolts.

Install your four provided AWE exhaust tips, as shown in **Figure 26**. Torque bolts to 18 ft/lbs



## STEP 27

To install the exhaust tips with integrated clamps, first, attach the exhaust tip in the proper orientation onto the exhaust outlet tube.

Insert one of the carriage bolts from the hardware kit **(3910-41010)** through the tab on the exhaust tip and thread on one of the corresponding nuts.

Using anti-seize on the bolt threads will help installation and prevent breakage of hardware.

 This exhaust system only has 2 exhaust tips while the integrated clamp kit has enough hardware for our 4 tip exhaust systems. You will have 2 sets of hardware left over that will not be used.

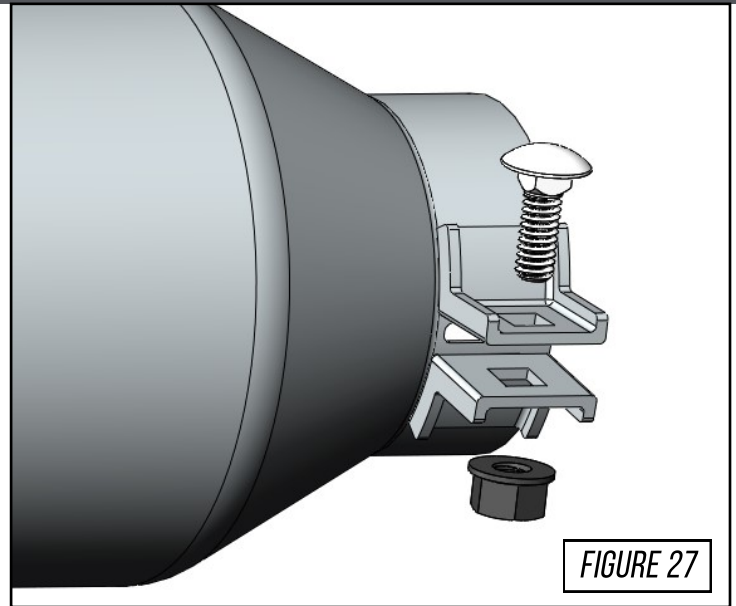

## STEP 28

Go back across the exhaust system one last time to check for contact and tighten the Accu-seal clamps. Accu-seal clamps should be tightened to at least 60 ft-lbs and the tubes should be adjusted so that the tips sit evenly in the rear bumper. At this point installation is complete!



# ENJOY!



## TROUBLESHOOTING

Issue	Solution
Exhaust is not fitting correctly	Most fitment issues are due to improperly adjusted exhaust. This includes tip fitments and rattling due to chassis contact. Check out our <a href="#">fitment guide</a> for more installation tips.
Wrong or missing parts	Double check the parts list for your system and compare them with what you received. Fill out our contact form, found below and let us know what parts you need.

## CARE

Once installed properly, your AWE exhaust will provide years of trouble-free performance.

The exhaust volume and sound will settle with usage; 800-1000 miles is required to break-in new exhaust systems.

Also, please note that the rear **180Technology®** resonator has a small drain hole to allow condensation to escape. Water drops from this area are normal.

Periodic cleaning of exhaust tips is necessary to maintain proper finish, especially in areas prone to road salt and caustic deicing solutions. Use a mild soap and water solution or car wax to clean the finish. Avoid using abrasive polishes, as they can scratch the finish.

Any questions or comments,  
please do not hesitate to contact us:

**AWE**

215-658-1670

[CONTACT FORM](#)

## WARRANTY

Up-to-date warranty information is found [HERE](#).