



## INSTALLATION GUIDE: AWE EXHAUST SUITE FOR THE BMW G8X M3/M4

For up-to-date fitment information, please visit the product page on [AWE-Tuning.com](https://www.awe-tuning.com).

### THIS GUIDE IS INTENDED FOR THE FOLLOWING PART NUMBERS:

- 3025-42480 AWE SwitchPath Catback Exhaust for BMW G8X M3/M4 - Diamond Black Tips
- 3025-43480 AWE SwitchPath Catback Exhaust for BMW G8X M3/M4 - Chrome Silver Tips
- 3020-42482 AWE Track Edition Catback Exhaust for BMW G8X M3/M4 - Diamond Black Tips
- 3020-43482 AWE Track Edition Catback Exhaust for BMW G8X M3/M4 - Chrome Silver Tips
- 3820-11489 AWE Non-Resonated Performance Mid Pipe for BMW G8X M3/M4

Welcome to the AWE family, and congratulations on your purchase of the AWE Exhaust System for the BMW G8X M3/M4.

Exquisite build quality and craftsmanship, coupled with industry leading performance, distinguish this exhaust system from all others.

\*For up to the minute fitment information, be sure to visit the AWE website. As always, AWE Performance Specialists are standing by for any questions, [right here](#).

### **Table of Contents:**

Performance MidPipe Installation.....	5
AWE Catback Installation.....	8
AWE Track Rear Installation.....	14
AWE Switchpath Rear Installation...	19

# PARTS LIST (PERFORMANCE MIDPIPES)



Inspect **ALL** parts prior to disassembly of vehicle; If damaged or **MISSING**, please contact the place of purchase immediately.



**PRO-TIP:** Installation of any exhaust should be performed by an experienced professional with the necessary equipment and know-how to effectively complete the install.

Symbol	Part Number	Description	QTY
	E54	BMW G8X M3-M4 Non Res Performance Midpipe Driver	1
	E55	BMW G8X M3-M4 Non Res Performance Midpipe Passenger	1

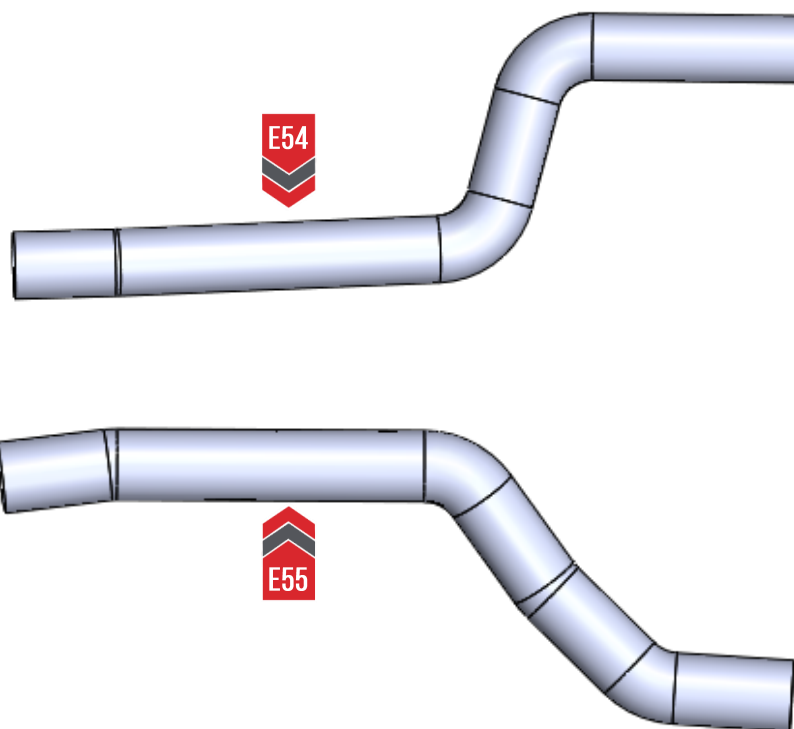

# PARTS LIST (SWITCHPATH SYSTEMS)



Inspect **ALL** parts prior to disassembly of vehicle; If damaged or **MISSING**, please contact the place of purchase immediately.



**PRO-TIP:** Installation of any exhaust should be performed by an experienced professional with the necessary equipment and know-how to effectively complete the install.

Symbol	Part Number	Description	QTY
	E56	BMW G8X M3-M4 Ball Adapter DS/PS	2
	E57	BMW G8X M3-M4 X Pipe	1
	E58	BMW G8X M3-M4 Axle Tube Driver	1
	E59	BMW G8X M3-M4 Axle Tube Passenger	1
	E60	BMW G8X M3-M4 Switchpath Valve Section Driver	1
	E61	BMW G8X M3-M4 Switchpath Valve Section Passenger	1
	E62	BMW G8X M3-M4 Switchpath Chamber Assembly	1
<b>A</b> >>	1325-11029	Wire Harness Extension	2
<b>B</b> >>	SEC75	3" Barrel Clamp (Bubble)	2
<b>C</b> >>	180300	AWE Band Clamp 3"	6
<b>D</b> >>	180275	AWE Band Clamp 2.75"	2
<b>E</b> >>	3910-41010	Hardware Kit for Integrated Clamp Style Exhaust Tips	1
<b>F</b> >>	3910-11034	3/8" CLAMP-KIT	1
<b>G</b> >>	180015	AWE 4.5" Slash Cut Diamond Black Tip	4
	180014	AWE 4.5" Slash Cut Chrome Silver Tip	4

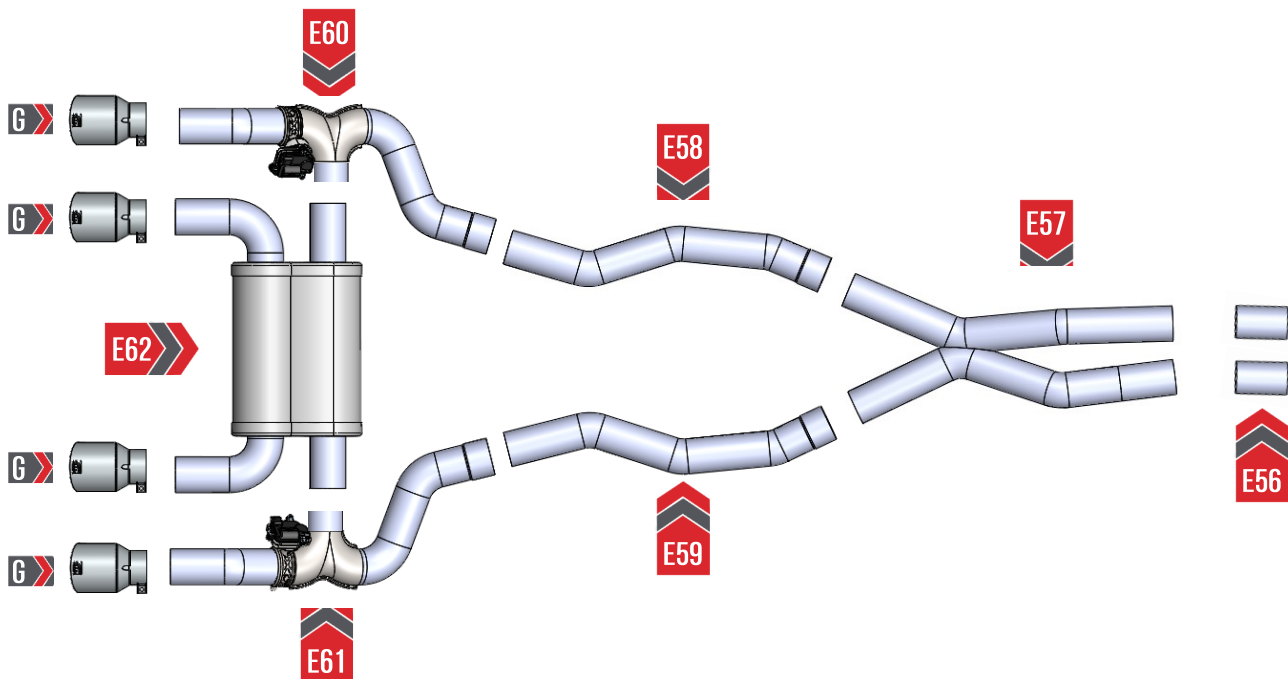

# PARTS LIST (TRACK SYSTEMS)



Inspect **ALL** parts prior to disassembly of vehicle; If damaged or **MISSING**, please contact the place of purchase immediately.



**PRO-TIP:** Installation of any exhaust should be performed by an experienced professional with the necessary equipment and know-how to effectively complete the install.

Symbol	Part Number	Description	QTY
	E56	BMW G8X M3-M4 Ball Adapter DS/PS	2
	E57	BMW G8X M3-M4 X Pipe	1
	E58	BMW G8X M3-M4 Axle Tube Driver	1
	E59	BMW G8X M3-M4 Axle Tube Passenger	1
	E63	BMW G8X M3-M4 Track Section Driver	1
	E64	BMW G8X M3-M4 Track Section Passenger	1
<b>A</b> >>	150004	SBS Valve Motor Simulator	2
<b>B</b> >>	9830A457	416 Stainless Steel Dowel Pins, 7/64" Diameter, 1" Long	2
<b>C</b> >>	SEC75	3" Barrel Clamp (Bubble)	2
<b>D</b> >>	180300	AWE Band Clamp 3"	4
<b>E</b> >>	180275	AWE Band Clamp 2.75"	2
<b>F</b> >>	3910-41010	Hardware Kit for Integrated Clamp Style Exhaust Tips	1
<b>G</b> >>	3910-11034	3/8" CLAMP-KIT	1
<b>H</b> >>	7130K59	7.5" Zip Tie	4
	180015	AWE 4.5" Slash Cut Diamond Black Tip	4
	180014	AWE 4.5" Slash Cut Chrome Silver Tip	4

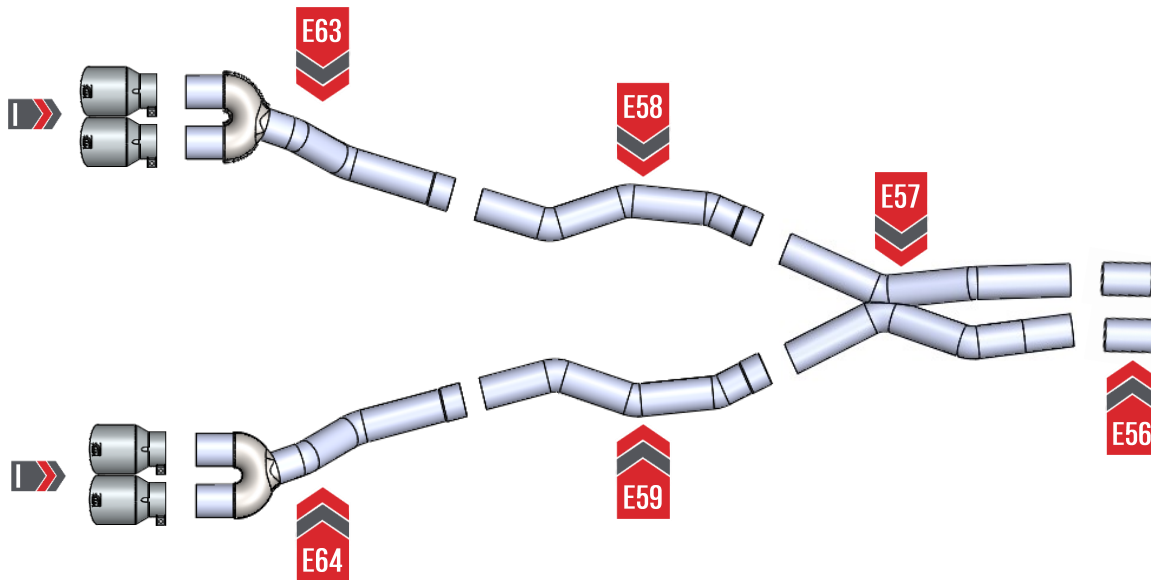





**NOTE:** Always refer to the manufacturer's service manual for precise torque specifications on all OEM fasteners.



**CAUTION:** The exhaust may be **VERY HOT** — allow adequate time for the system to cool down before disassembly. Severe burns and injury will occur if skin comes into contact with a hot exhaust system.



If you are **NOT** installing AWE performance midpipes skip to step 6.



## STEP 1

To start you will measure your cut points. The driver's side cut point is 60mm forward of the hanger bar bracket behind the catalytic converter, as shown in **Figure 1-1**.

The passenger side cut point is 108mm behind the mounting bracket on the rear of the catalytic converter, as shown in **Figure 1-2**.



**These measurements are crucial to the installation of the AWE performance midpipes. Ensure they are correct before cutting the OE system**

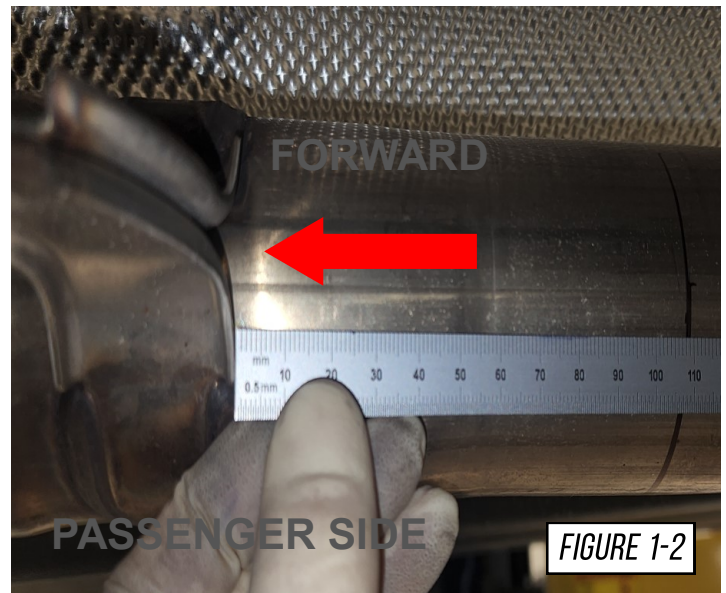
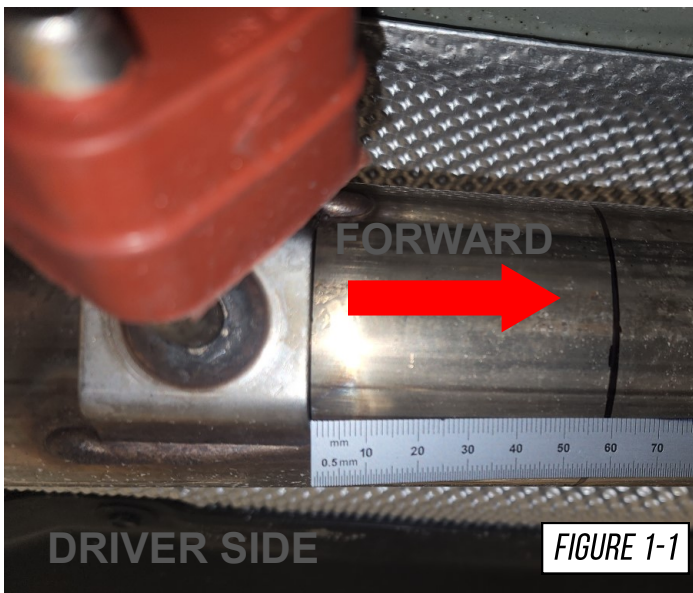

## STEP 2

After ensuring that your measurements are correct, cut the OE tubes.

**Note:** It is crucial that these cuts are accurate. Incorrect cuts will affect fitment.



**Make sure that the cuts are perpendicular to the tube you are cutting.**

**Note:** The system can be cut out of the car, but measurements must be taken and marked while the system is in the car.

## STEP 3



**Soak all bolts and rubber hangers in penetrating oil before starting any work.**

1. To begin you will need to remove the OE chassis brace, shown at **(A)**.
2. Place a pole jack on the resonator and rear muffler, as shown at **(B)**.
3. Slide the rubber hangers off of the hanger bar, as shown at **(C)**.
4. Unbolt the OE hangers, shown at **(D)**. This will allow you to fully remove the factory system.
5. Disconnect the OE valves **(E)** from their harnesses.
6. Remove the OE exhaust system.
7. **Re-round and debur the OE tubes at the cut points.**

**Note: The OE hangers and hardware will be reused. Make sure to keep the hangers separated as they will need to go back into their original locations.**

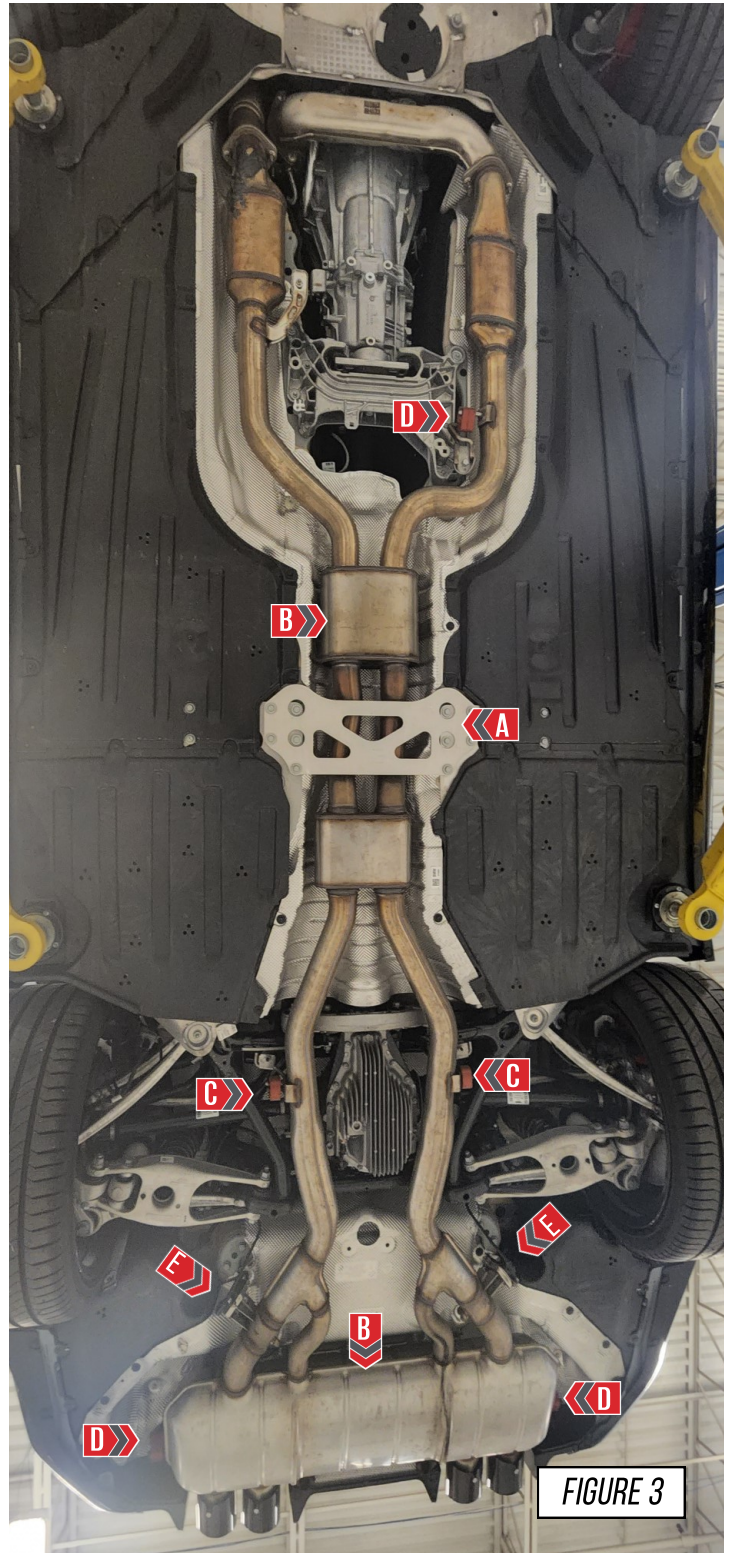

FIGURE 3



## STEP 4

Install your driver side AWE non-resonated performance mid-pipe (**E54**), first slide a provided 3" clamp over the expanded side of the tube. Bottom the slip fit out on the backside of the OE catalytic converter, as shown in **Figure 4-1**. Then re-install the OE hanger by first sliding the rubber hanger onto the bar (**A**), before re-installing the factory bolt as shown at (**B**) in **Figure 4-2**. Ensure the hanger bar is parallel to the ground.

**Note:** The provided clamps can be found packed with your AWE catback system.

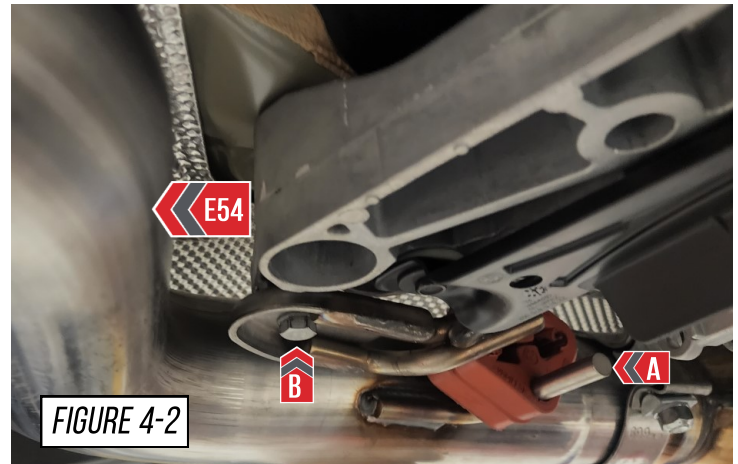

## STEP 5

Install your passenger side AWE non resonated performance mid-pipe (**E55**), first slide a provided 3" clamp over the expanded side of the tube. Bottom the slip fit out on the backside of the OE catalytic converter, as shown in **Figure 5-1**.

Next rotate passenger side AWE non resonated mid-pipe (**E55**) so it is parallel with the driver's side (**E54**), as shown in **Figure 5-2**.





## AWE CATBACK INSTALL STARTS HERE



### STEP 6

To start you will measure your cut points. The cut points will be between 185mm and 190mm forward of the second resonator (smooth face) for the driver, and passenger side tubes, as shown in **Figure 3**.



**It is crucial that you measure the same distance on each tube. Different measurements on each tube will effect fitment.**



### STEP 7

After ensuring that your measurements are correct, cut the OE tubes.

**Note: It is crucial that these cuts are accurate, and perpendicular to the tube you are cutting. Incorrect cuts will affect fitment.**

**Note: The system can be cut out of the car, but measurements must be taken and marked while the system is in the car.**



## STEP 8



**Soak all bolts and rubber hangers in penetrating oil before starting any work.**

1. To begin you will need to remove the OE chassis brace, shown at **(A)**.
2. Place a pole jack on the resonator and rear muffler, as shown at **(B)**.
3. Slide the rubber hangers off of the hanger bar, as shown at **(C)**.
4. Unbolt the OE hangers, shown at **(D)**. This will allow you to fully remove the factory system.
5. Disconnect the OE valves **(E)** from their harnesses.
6. Remove the OE exhaust system.
7. **Re-round and debur the OE tubes at the cut points.**

**Note: The OE hangers and hardware will be reused. Make sure to keep the hangers separated as they will need to go back into their original locations.**

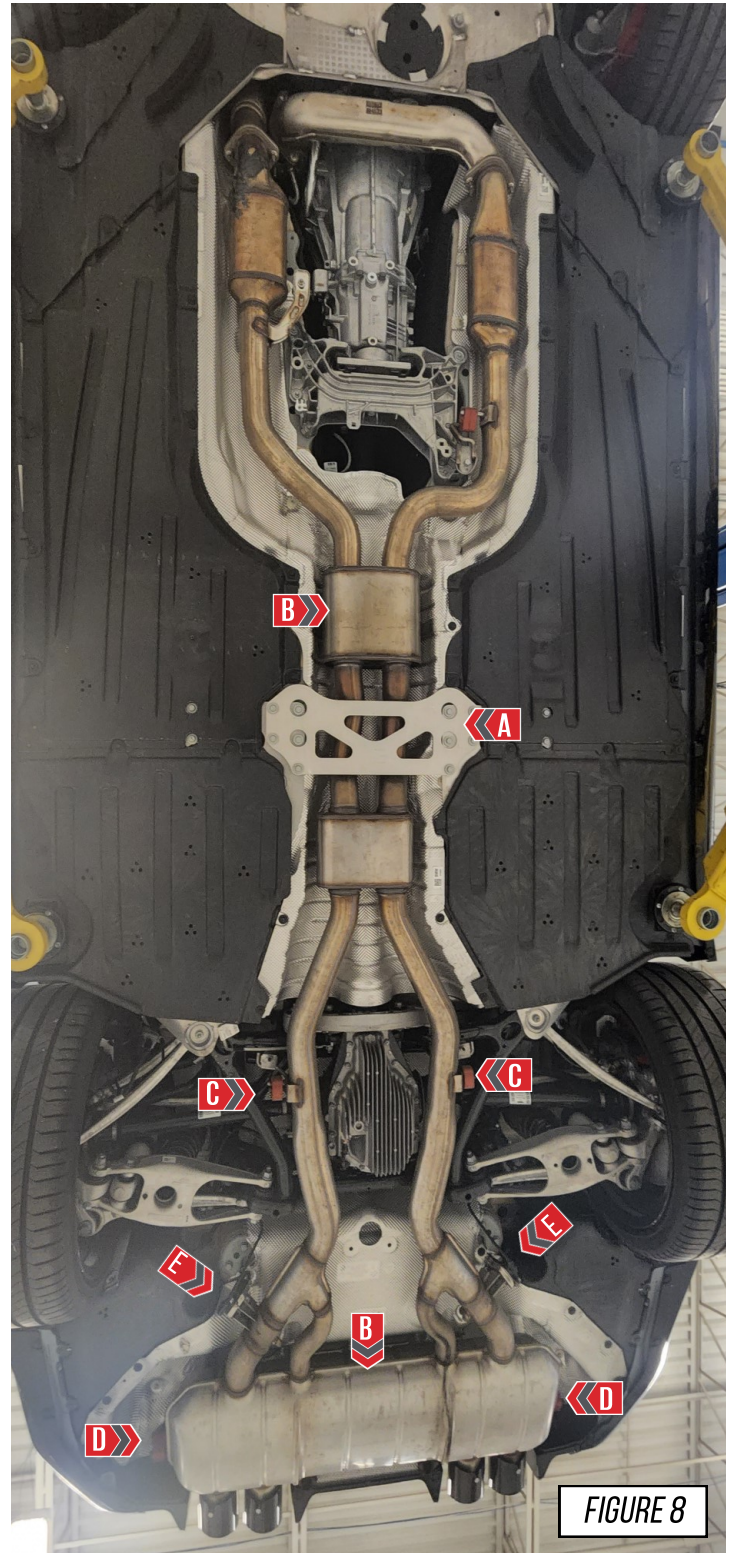

## STEP 9

Install you 2 AWE ball socket adapters (**E56**) onto the cut ends of the OE system, as shown in **Figure 9**. Do this by sliding the provided 2.75" clamps on to the ball socket adapters, bottom the slip fit out, and tighten the clamps.

**Note:** The AWE ball socket adapters should sit flush with each other when installed correctly.

**Note:** Skip this step IF you have installed AWE performance midpipes.

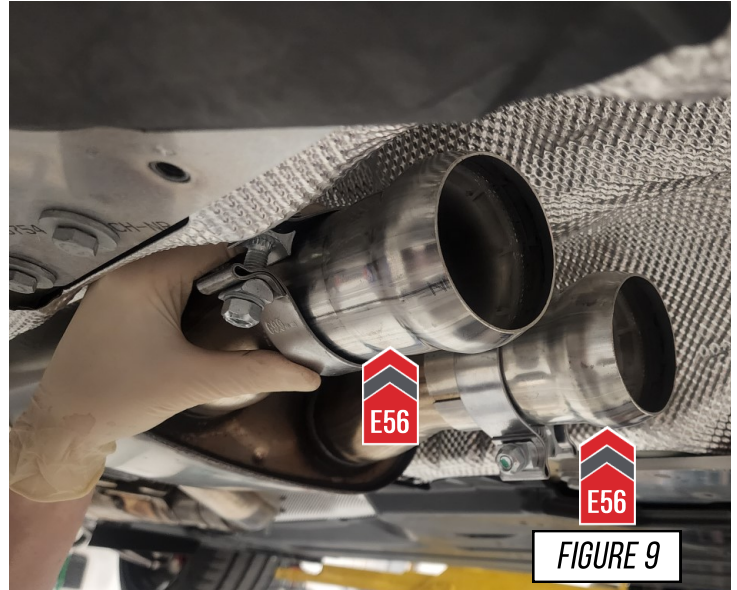

## STEP 10

Slide a provided 3" barrel clamp over each flared end of your AWE X-pipe (**E57**) and install it onto the ball socket adapters, as shown in **Figure 10**.

Snug the clamps, but do not fully tighten them at this time.





## STEP 11

When you snug the clamps on your AWE ball socket adapters/midpipes, and your AWE X-pipe, it is important to have the drivers side clamps at the rotation shown in **Figure 11-1** and the passenger side clamps at the rotation shown in **Figure 11-2**. This rotation will ensure proper fitment when the chassis brace is re-installed.

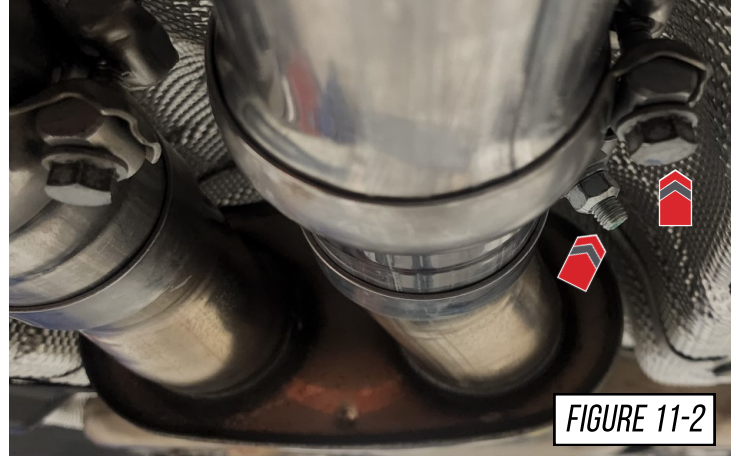
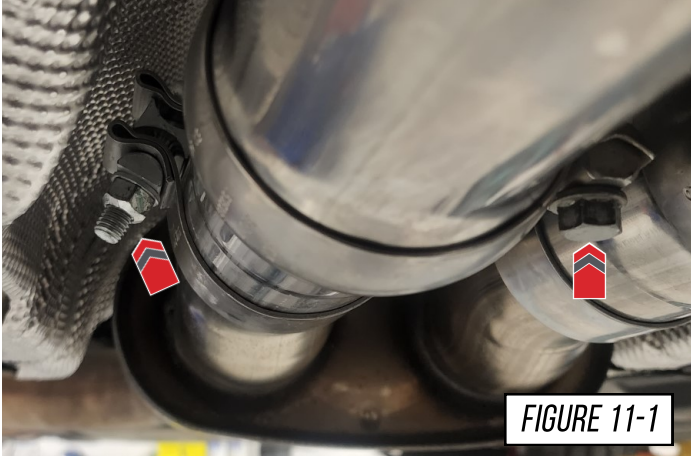

## STEP 12

Reinstall the OE hanger located near the differential, as shown in **Figure 12**. Repeat this for the other side of the car.

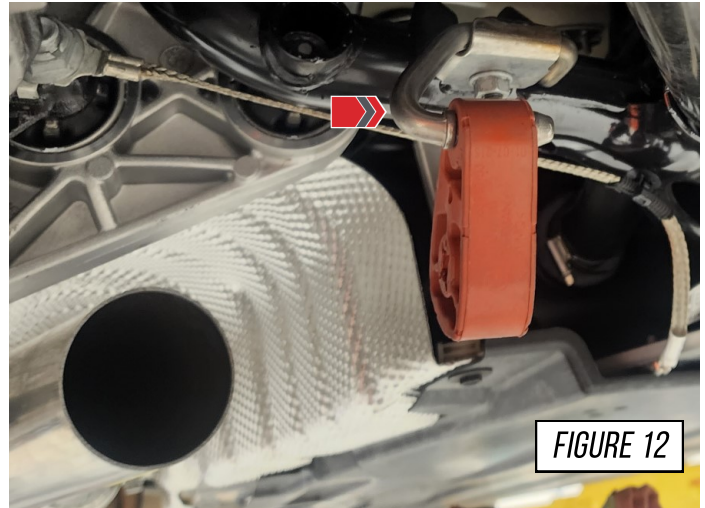

## STEP 13

Install your AWE passenger side axle tube (**E59**) by sliding a provided 3" band clamp over the expanded end. Slide the hanger bar into the OE rubber hanger (**A**), then bottom the slip fit out on the AWE X-pipe (**E57**), as shown in **Figure 13**.

Snug the clamp on the slip fit, but do not fully tighten at this time.

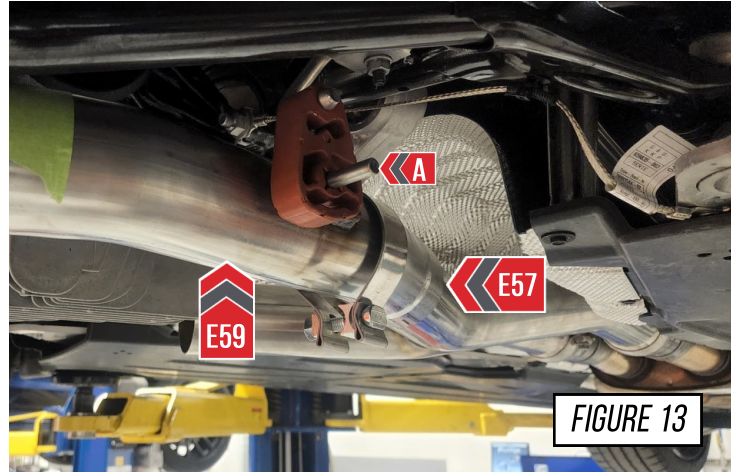

## STEP 14

Install your AWE driver side axle tube (**E58**) by sliding a provided 3" band clamp over the expanded end. Slide the hanger bar into the OE rubber hanger (**A**), then bottom the slip fit out on the AWE X-pipe (**E57**), as shown in **Figure 14**.

Snug the clamp on the slip fit, but do not fully tighten at this time.

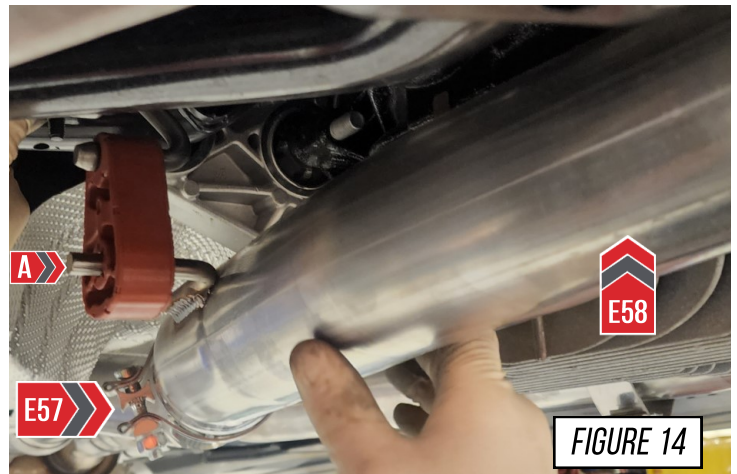

## STEP 15

It is crucial to install each section and exhaust band clamps correctly to prevent loose joints, exhaust leaks and rattles.

**Arrow A** shows the expanded pipe and the preinstalled exhaust clamp being brought up to the corresponding pipe.

**Arrow B** shows the overlapping pipe installed correctly over the corresponding pipe.

**Arrow C** shows the exhaust band clamp being brought to the edge of the expanded pipe.



### NOTES:

- **Do not** fully torque any exhaust clamp until the entire exhaust has been installed and adjusted.
- Torque specification is a **minimum** of 60 ft/lbs

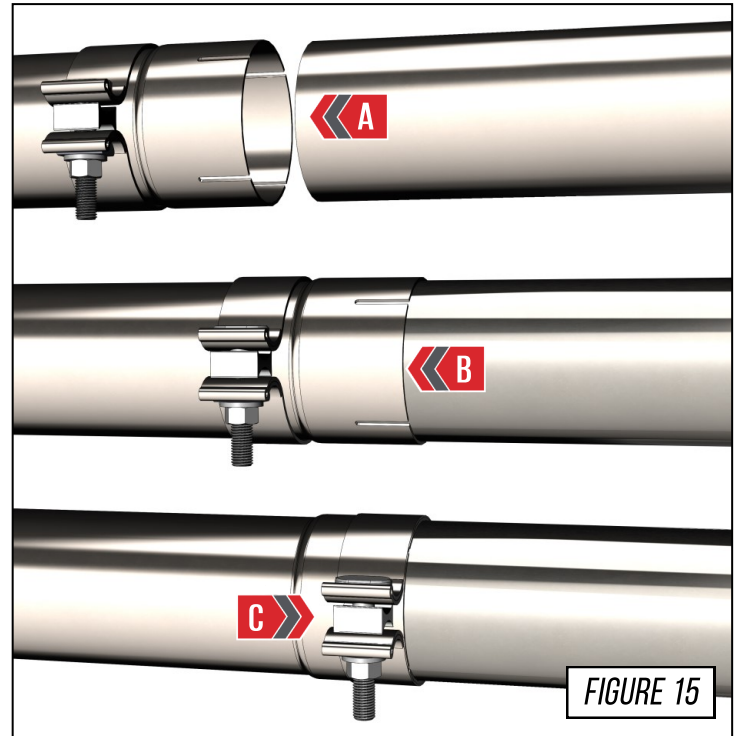

**TRACK SYSTEM INSTALLATION: SKIP TO STEP 16**



**SWITCHPATH SYSTEM INSTALLATION: SKIP TO STEP 27**







## STEPS 16–26 ARE FOR TRACK SYSTEMS ONLY



### STEP 16

Install your AWE passenger side track section (**E64**). First bolt the OE rubber hanger back into place, as shown at (**A**) in **Figure 16**. Then slide a provided 3" band clamp over the expanded end of your AWE track section (**E64**).

Next slide the hanger bar into the OE rubber hanger, as shown at (**B**) in **Figure 16**. Now bottom out the slip fit on the AWE passenger axle tube (**E59**).

Snug the clamp down on the slip fit, but do not tighten fully at this time.

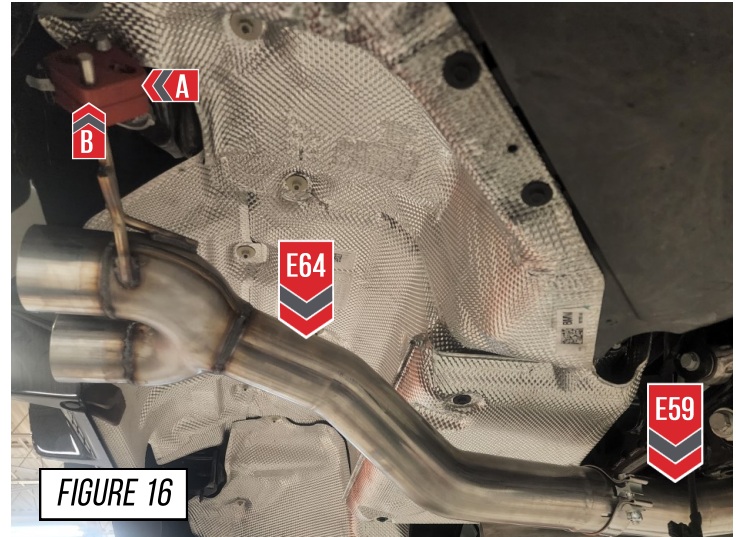

### STEP 17

Install your AWE passenger side track section (**E63**). First bolt the OE rubber hanger back into place, as shown at (**A**) in **Figure 17**. Then slide a provided 3" band clamp over the expanded end of your AWE track section (**E63**).

Next slide the hanger bar into the OE rubber hanger, as shown at (**B**) in **Figure 17**. Now bottom out the slip fit on the AWE passenger axle tube (**E58**).

Snug the clamp down on the slip fit, but do not tighten fully at this time.

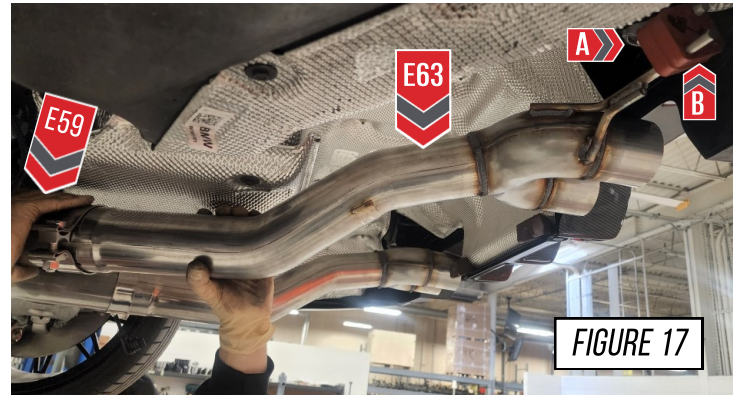

## STEP 18

Remove the OE valves from the OE exhaust system.

**Note: Keep drivers side and passenger side separated. It is important to install the valves on their original sides of the car.**

Next gather your valve motor simulators (A) and your dowel pins (B). Place the dowel pin in the cut out on the bucket shown in Figure 18.



## STEP 19

To ensure you have the valve simulator aligned correctly, flip it over and verify that the dowel is resting in the cut out of the valve motor pin, as shown in Figure 19.

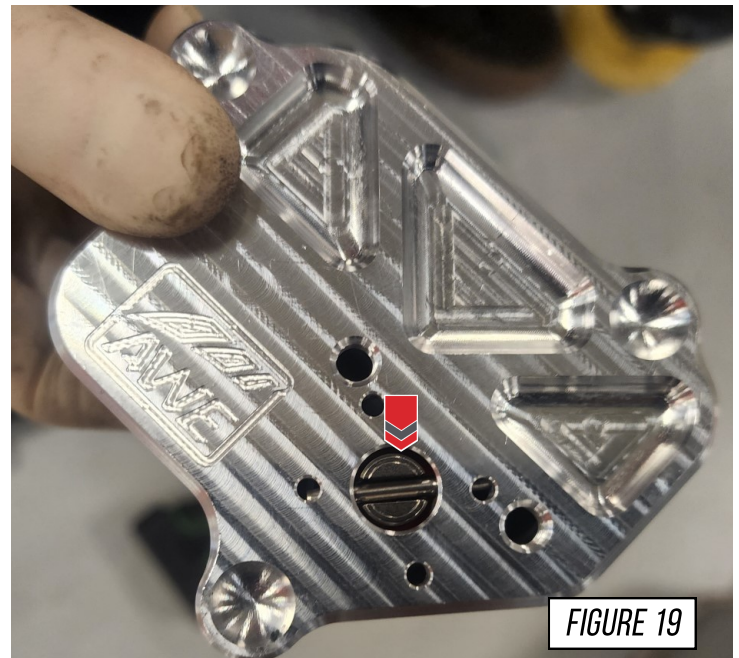

## STEP 20

Using the OE hardware that was removed earlier, secure the valve motor to the AWE valve simulator bracket, as shown in **Figure 20**.

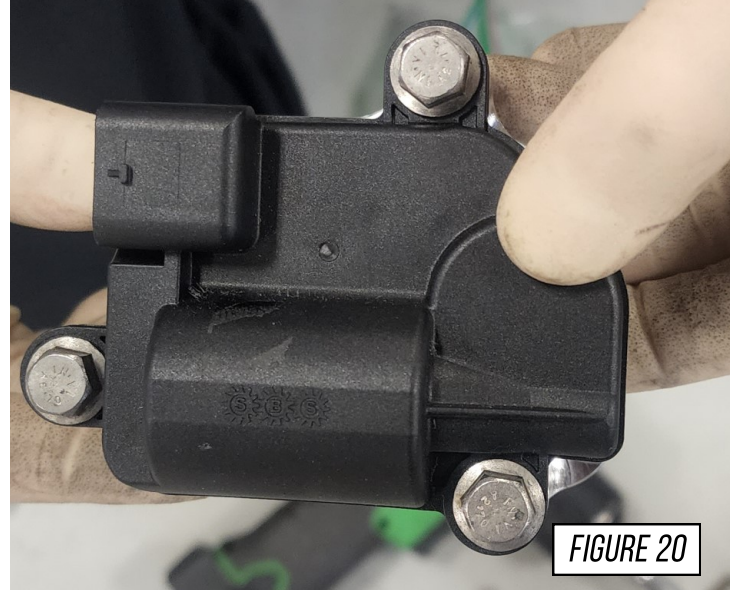

## STEP 21

Using the provided cable ties, secure the valve motor simulator bracket (**A**) to the subframe above the AWE driver side axle tube (**E58**), as shown in **Figure 21**.

**Note: Use 2 cable ties per valve simulator**

Repeat this process for the passenger side.

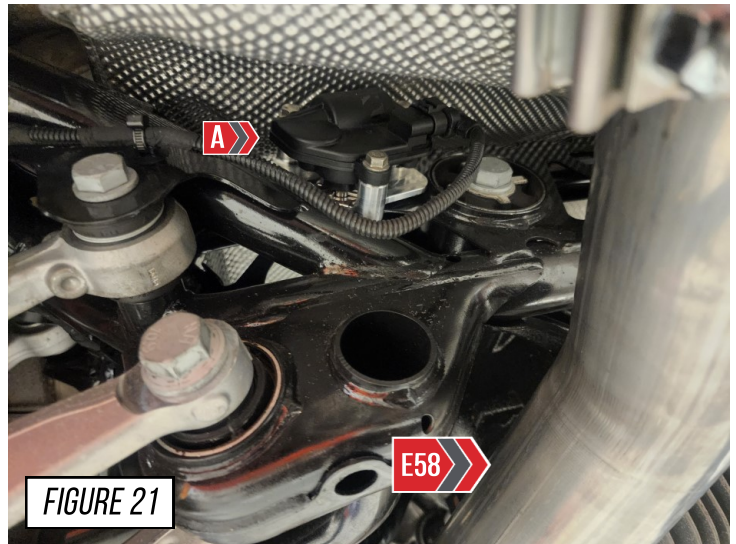

## STEP 22

Install all 4 AWE exhaust tips onto the tip outlets with the provided hardware, as shown in **Figure 22**.

**Note: When installing tips be careful not to scratch the rear valance**





## STEP 23

To install the exhaust tips with integrated clamps, first, attach the exhaust tip in the proper orientation onto the exhaust outlet tube.

Insert one of the carriage bolts from the hardware kit (**3910-41010**) through the tab on the exhaust tip and thread on one of the corresponding nuts.

Using anti-seize on the bolt threads will help installation and prevent breakage of hardware.

 If exhaust system only has 2 exhaust tips while the integrated clamp kit has enough hardware for our 4 tip exhaust systems. You will have 2 sets of hardware left over that will not be used.

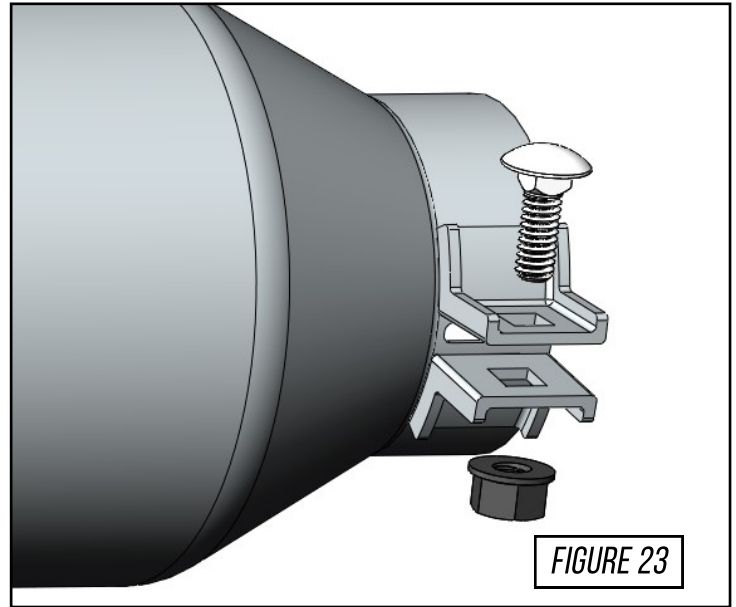

## STEP 24

Install a provided lock collar on the outside of the driver side rubber gromet, as shown at **(A)** in **Figure 24**.

Repeat on the passenger side.

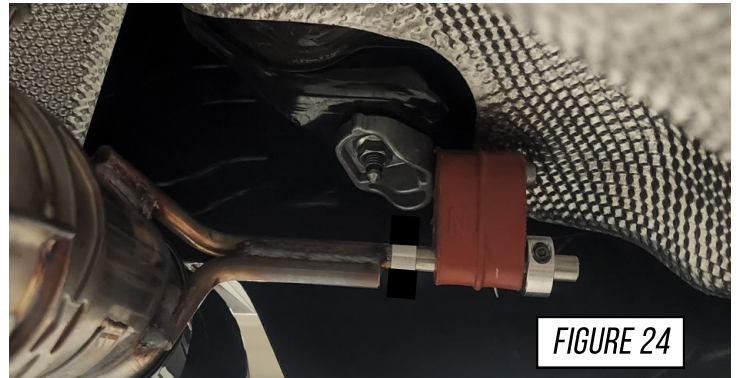

## STEP 25

Re-install the OE chassis brace (A) using the OE hardware, as shown in **Figure 25**.



## STEP 26

Make your final adjustments to the tips to ensure they are in a position you like. Once the desired positioning is achieved work from the front of the car to the back, tightening all the clamps fully and ensuring there is proper clearance of the chassis, and braces.

It is now recommended to drive the car to allow the exhaust to heat cycle after all clamps and tips are fully tightened.

 At this point the exhaust will be **very hot**, allow to cool before work continues.

Check the tips for correct alignment, adjust as needed.

 Don't forget to see the next page for any troubleshooting needs!



# ENJOY!





## STEPS 27– 38 ARE FOR SWITCHPATH SYSTEMS ONLY



### STEP 27

Remove the OE hardware (A) that secures the heat shield on one side of the car, as shown in **Figure 27-1**

Connect your AWE extension harness to the driver side OE plug (B) as shown in **Figure 27-2**

Tuck your AWE wiring harness extension above the heat shield as shown in **Figure 27-3**.

Repeat for the opposite side of the vehicle.

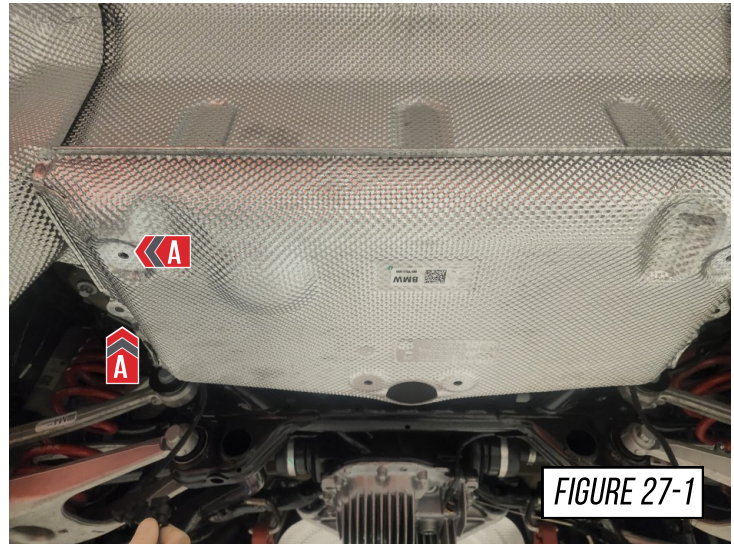

FIGURE 27-1



FIGURE 27-2

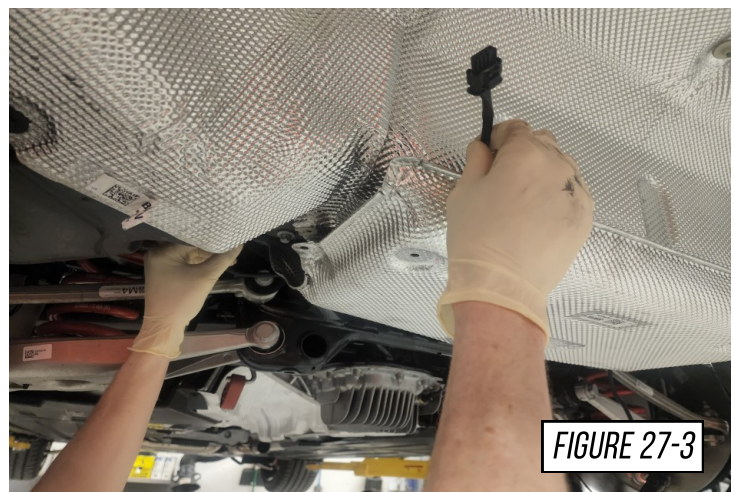

FIGURE 27-3



## STEP 28

Install the provided valve spring (A) into your AWE Switchpath passenger valve section (E61), as shown in **Figure 28-1**.

Next use the provided hardware to install the OE valve motor (B), as shown in **Figure 28-2**.

Last check to make sure the valve motor and spring are sitting, as shown at (C) in **Figure 28-3**.

**Note:** Remove the OE valve motors from your OE system. Do not flip the driver and passenger side valves. They must be installed on their original sides.

**Note:** The provided spring must be used or the valves may not function correctly.

 Repeat this process for your AWE valve section on the driver side

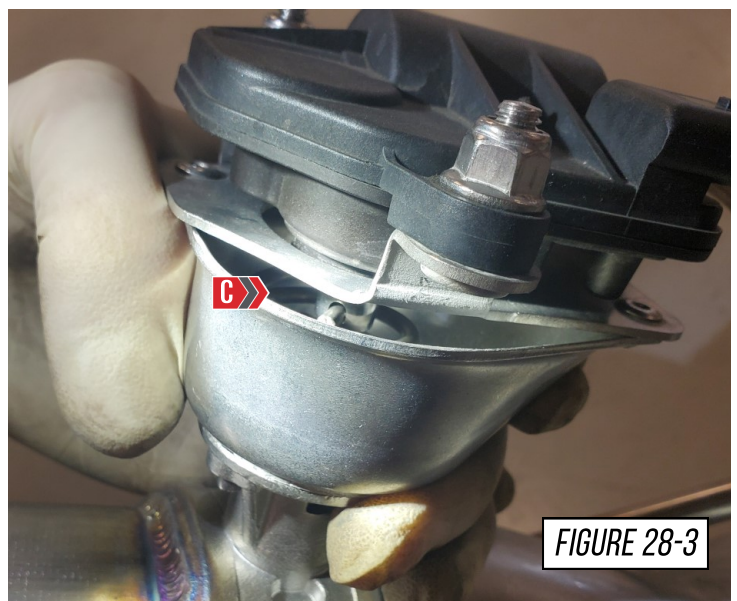
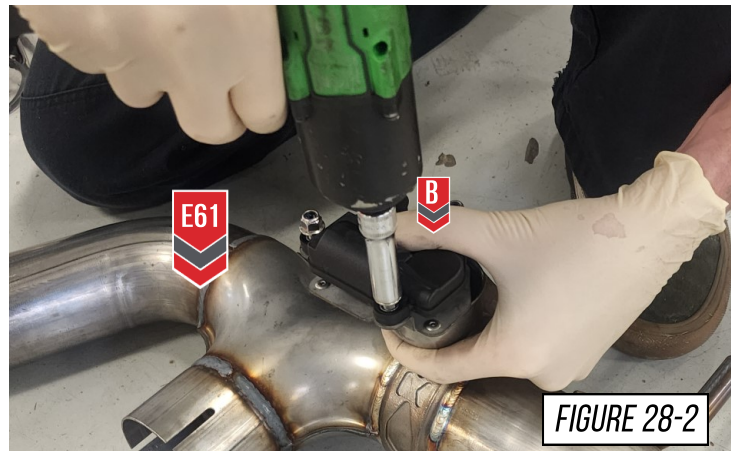
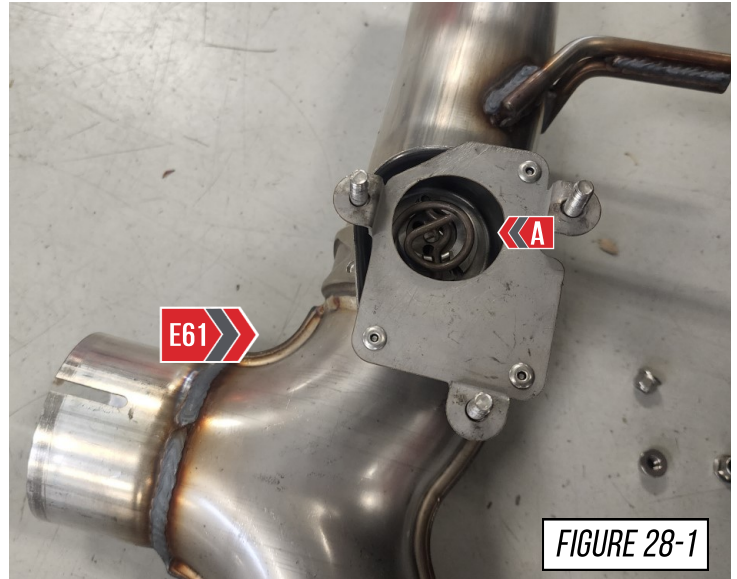

## STEP 29

Install your AWE Switchpath valve sections (**E60/E61**) by sliding a clamp over the expanded slip fit and then bottom out the slip fit on the AWE Switchpath Chamber Assembly (**E62**), as shown in **Figure 29**.

Snug the clamps on both sides once the slip fits are installed. Do not fully tighten the clamps at this time.

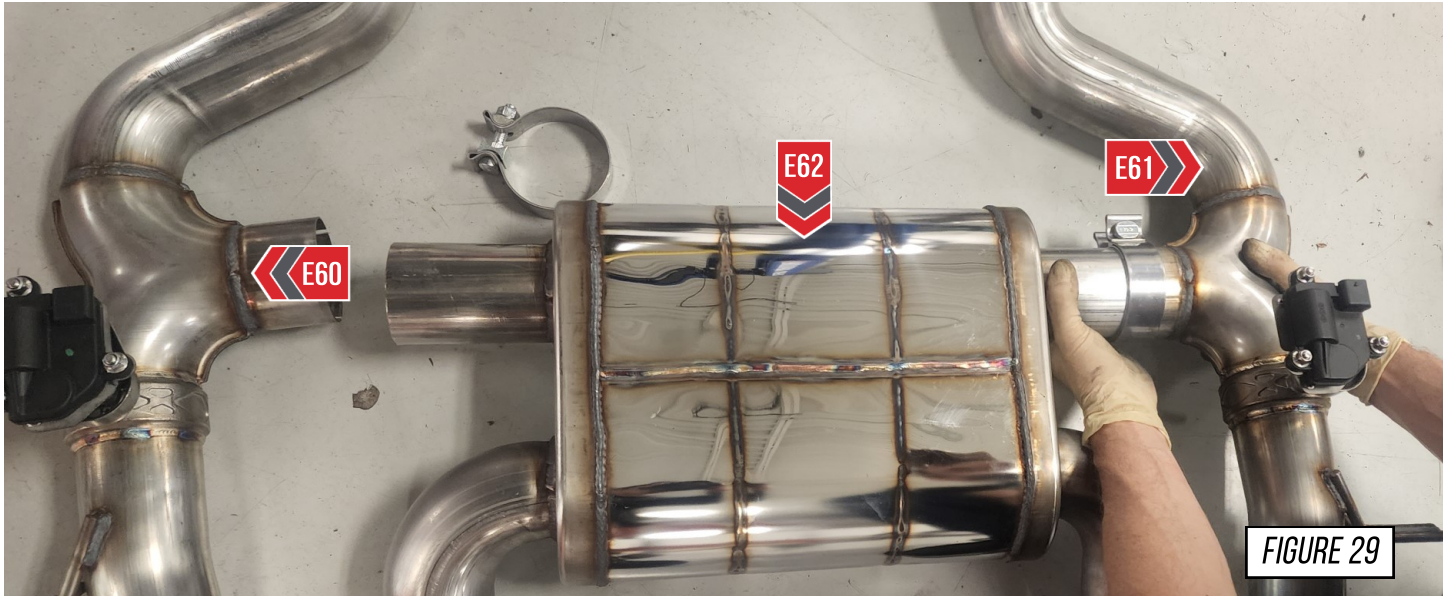

FIGURE 29

## STEP 30

Slide the OE rubber hanger grommets onto the hanger bars on each side of the AWE Switchpath Valve Sections.

**Note:** Make sure to install the OE rubber grommets on the side which they originally came off of.



FIGURE 30



## STEP 31

Install the entire AWE Switchpath rear assembly onto the AWE axle tubes (E58/E59), as shown in **Figure 31**. First slide a provided clamp over the axle tubes. Then line up the assembly with the axle tubes, and bottom out the slip fits on the tubes.

**Note:** It is recommended to have another person help to lift the rear assembly into place.

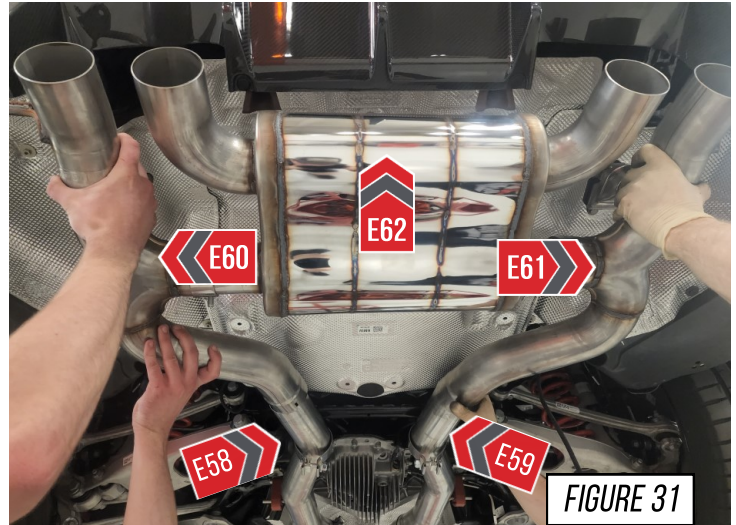

## STEP 32

Re-secure the OE rubber hanger using the OE hardware as shown at (A) in **Figure 32**.

Repeat this for the opposite side.



## STEP 33

Plug your AWE wiring harness extension into the valve as shown at (A) **Figure 33**.

Repeat this for the opposite side.

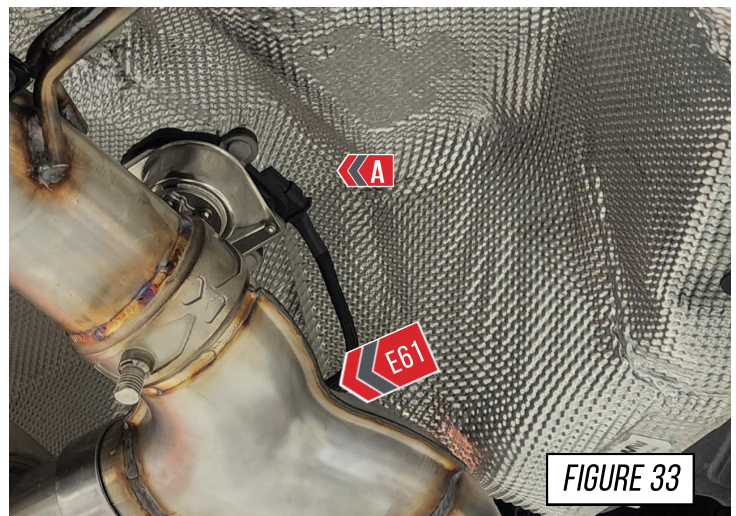



## STEP 34

Install all 4 AWE exhaust tips onto the tip outlets with the provided hardware, as shown in **Figure 34**.

**Note: When installing tips be careful not to scratch the rear valance**



FIGURE 34

## STEP 35

To install the exhaust tips with integrated clamps, first, attach the exhaust tip in the proper orientation onto the exhaust outlet tube.

Insert one of the carriage bolts from the hardware kit (**3910-41010**) through the tab on the exhaust tip and thread on one of the corresponding nuts.

Using anti-seize on the bolt threads will help installation and prevent breakage of hardware.

 If exhaust system only has 2 exhaust tips while the integrated clamp kit has enough hardware for our 4 tip exhaust systems. You will have 2 sets of hardware left over that will not be used.

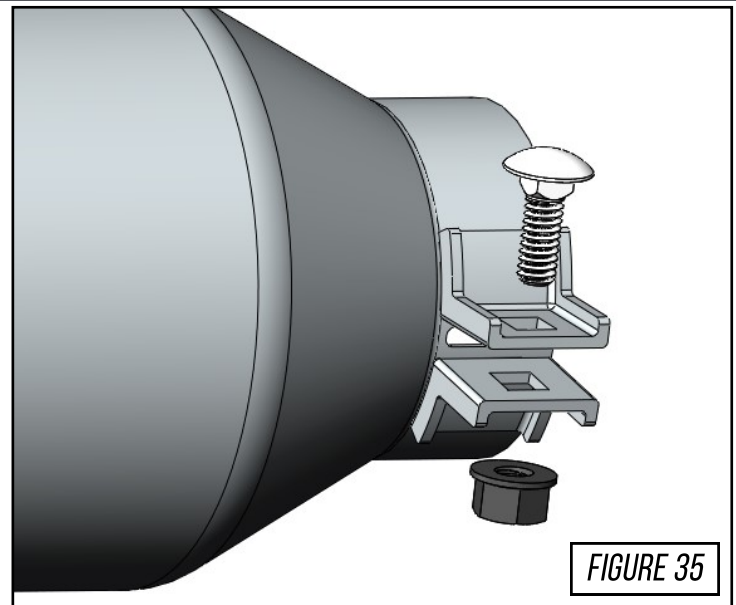

FIGURE 35

## STEP 36

Install a provided lock collar, on the outside of the driver side rubber gromet, as shown at **(A)** in **Figure 36**.

Repeat on the passenger side.

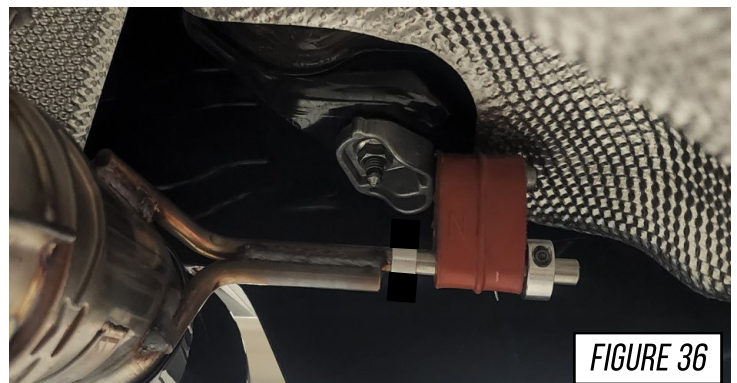

FIGURE 36

## STEP 37

Re-install the OE chassis brace (A) using the OE hardware, as shown in **Figure 37**.

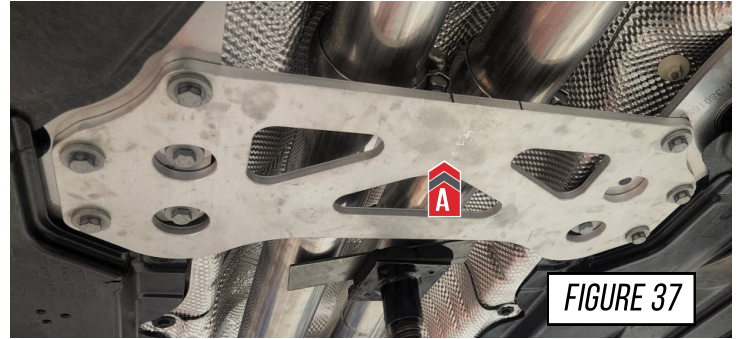



FIGURE 37

## STEP 38

Make your final adjustments to the tips to ensure they are in a position you like. Once the desired positioning is achieved work from the front of the car to the back, tightening all the clamps fully and ensuring there is proper clearance of the chassis, and braces.

It is now recommended to drive the car to allow the exhaust to heat cycle after all clamps and tips are fully tightened.

 At this point the exhaust will be **very hot**, allow to cool before work continues.

Check the tips for correct alignment, adjust as needed.

 Don't forget to see the next page for any troubleshooting needs!



FIGURE 38

# ENJOY!



# TROUBLESHOOTING

Issue	Solution
Exhaust is not fitting correctly	Most fitment issues are due to improperly adjusted exhaust. This includes tip fitments and rattling due to chassis contact. Check out our <a href="#">fitment guide</a> for more installation tips.
Incorrect or missing parts	Double check the parts list for your system and compare them with what you received. Fill out our contact form, found below and let us know what parts you need.

# CARE

Once installed properly, your AWE exhaust will provide years of trouble-free performance.

The exhaust volume and sound will settle with usage; 800-1000 miles is required to break-in new exhaust systems.

Also, please note that the rear **180Technology**® resonator has a small drain hole to allow condensation to escape. Water drops from this area are normal.

Periodic cleaning of exhaust tips is necessary to maintain proper finish, especially in areas prone to road salt and caustic deicing solutions. Use a mild soap and water solution or car wax to clean the finish. Avoid using abrasive polishes, as they can scratch the finish.

Any questions or comments,  
please do not hesitate to contact us:

**AWE**  
[CONTACT FORM](#)

# WARRANTY

Up-to-date warranty information is found [HERE](#).