



INSTALLATION GUIDE: AWE EXHAUST SUITE FOR THE C8 AUDI S6/S7

For up-to-date fitment information, please visit the product page on [AWE-Tuning.com](https://www.AWE-Tuning.com).

THIS GUIDE IS INTENDED FOR THE FOLLOWING PART NUMBERS:

- 3015-42103 AWE Touring Edition Exhaust for Audi C8 S6/S7 - Chrome Silver Tips
- 3015-43107 AWE Touring Edition Exhaust for Audi C8 S6/S7 - Diamond Black Tips
- 3020-42101 AWE Track Edition Exhaust for Audi C8 S6/S7 - Chrome Silver Tips
- 3020-43109 AWE Track Edition Exhaust for Audi C8 S6/S7 - Diamond Black Tips

Welcome to the AWE family, and congratulations on your purchase of the AWE Exhaust System for the C8 Audi S6/S7.

Exquisite build quality and craftsmanship, coupled with industry leading performance, distinguish this exhaust system from all others.

*For up to the minute fitment information, be sure to visit the AWE website. As always, AWE Performance Specialists are standing by for any questions, [right here](#).

PARTS LIST (TRACK SYSTEMS)



Inspect **ALL** parts prior to disassembly of vehicle; If damaged or **MISSING**, please contact the place of purchase immediately.

180015Symbol	Part Number	Description	QTY
	D36	A6/A7/S6/S7 DS Flex Section	1
	D37	A6/A7/S6/S7 PS Flex Section	1
	E90	Audi C8 RS6 Avant/RS7/A6/A7/S6/S7 Mid Section	1
	E91	Audi C8 RS6 Avant/RS7/A6/A7/S6/S7 Mid Tube Driver	1
	E92	Audi C8 RS6 Avant/RS7/A6/A7/S6/S7 Mid Tube Passenger	1
	E98	Audi C8 A6/A7/S6/S7 Axle Tube Assembly	1
	D44	A6/A7/S6/S7 DS Track Rear Section	1
	D45	A6/A7/S6/S7 PS Track Rear Section	1
	D46	S6/S7 ONLY DS Tip Section	1
	D47	S6/S7 ONLY PS Tip Section	1
A >>	180300	AWE Band Clamp: 3"	8
B >>	3910-41010	Hardware Kit for Integrated Clamp Style Exhaust Tips - Quad	1
C >>	SEC75	3" Barrel Clamp (Bubble)	2
D >>	3910-11012	CLAMP-KIT	1
E >>	3910-11020	Downpipe Hardware Kit - Requires 1 Kit per Flange	2
F >>	GA-6669	Electronic Valve Simulator	2
	180014	4.50" OD x 3.00" ID, Slash Cut, Silver Chrome, AWE Logo, Intergrated Clamp	4
G >>	180015	4.50" OD x 3.00" ID, Slash Cut, Diamond Black, AWE Logo, Intergrated Clamp	4

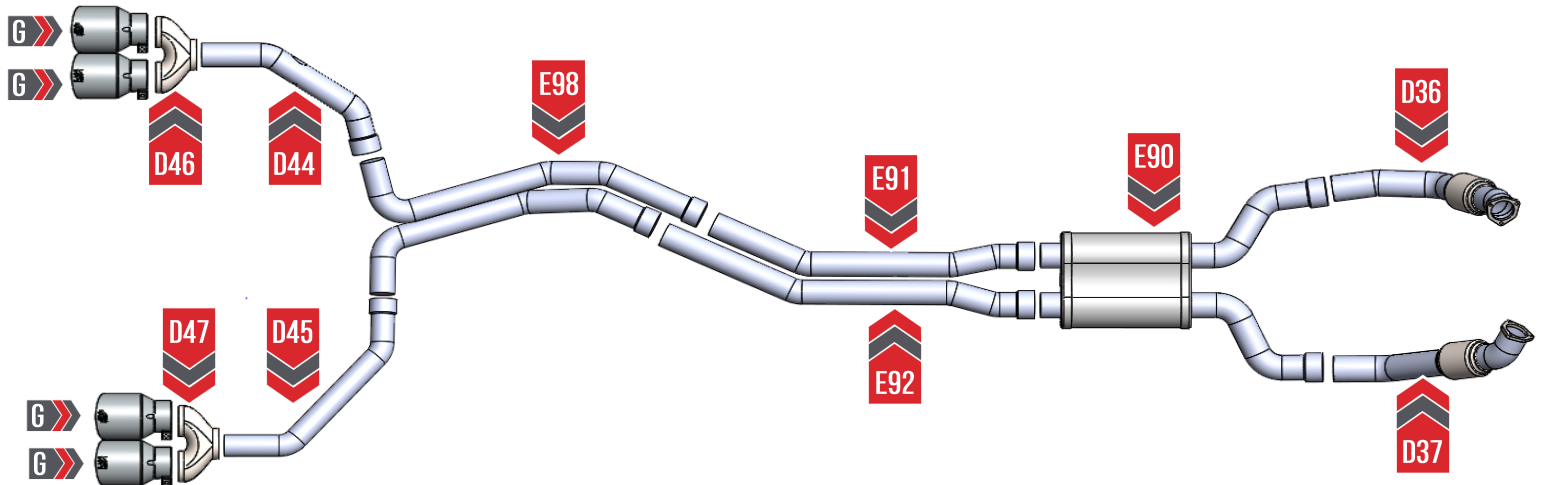

PARTS LIST (TOURING SYSTEMS)



Inspect **ALL** parts prior to disassembly of vehicle; If damaged or **MISSING**, please contact the place of purchase immediately.

180015Sy mbol	Part Number	Description	QTY
	D36	A6/A7/S6/S7 DS Flex Section	1
	D37	A6/A7/S6/S7 PS Flex Section	1
	E90	Audi C8 RS6 Avant/RS7/A6/A7/S6/S7 Mid Section	1
	E91	Audi C8 RS6 Avant/RS7/A6/A7/S6/S7 Mid Tube Driver	1
	E92	Audi C8 RS6 Avant/RS7/A6/A7/S6/S7 Mid Tube Passenger	1
	E98	Audi C8 A6/A7/S6/S7 Axle Tube Assembly	1
	D42	A6/A7/S6/S7 DS Touring Rear Section	1
	D43	A6/A7/S6/S7 PS Touring Rear Section	1
	D46	S6/S7 ONLY DS Tip Section	1
	D47	S6/S7 ONLY PS Tip Section	1
A >>	180300	AWE Band Clamp: 3"	8
B >>	3910-41010	Hardware Kit for Integrated Clamp Style Exhaust Tips - Quad	1
C >>	SEC75	3" Barrel Clamp (Bubble)	2
D >>	3910-11012	CLAMP-KIT	1
E >>	3910-11020	Downpipe Hardware Kit - Requires 1 Kit per Flange	2
F >>	GA-6669	Electronic Valve Simulator	2
	180014	4.50" OD x 3.00" ID, Slash Cut, Silver Chrome, AWE Logo, Intergrated Clamp	4
G >>	180015	4.50" OD x 3.00" ID, Slash Cut, Diamond Black, AWE Logo, Intergrated Clamp	4

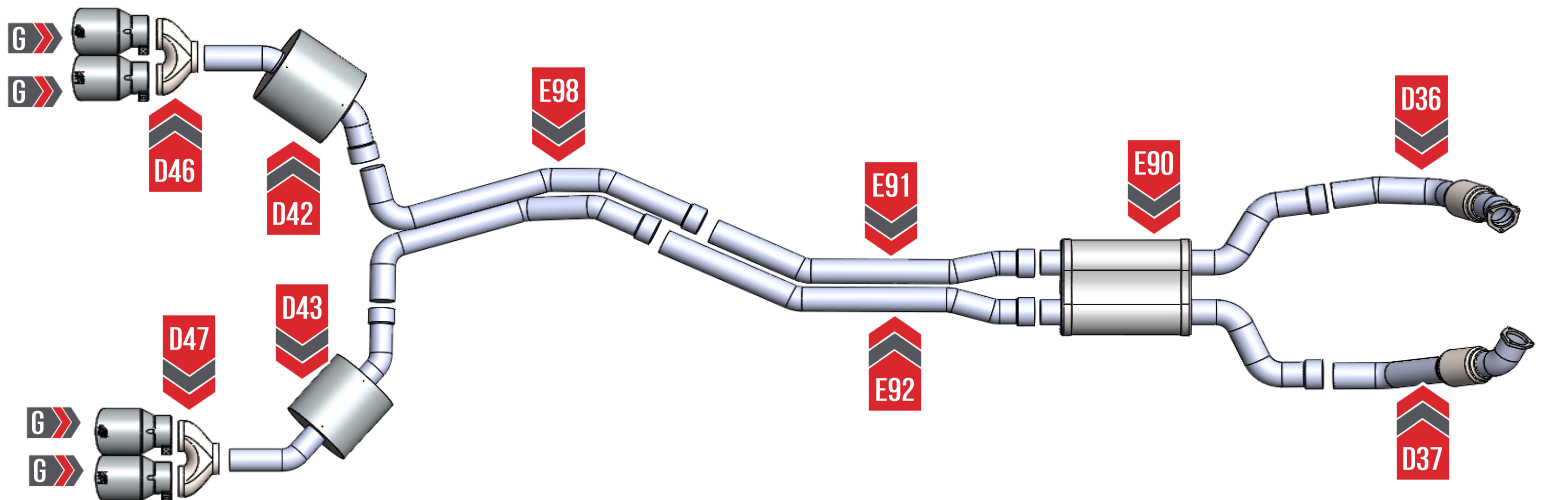



NOTE: Always refer to the manufacturer's service manual for precise torque specifications on all OEM fasteners.



CAUTION: The exhaust may be **VERY HOT** — allow adequate time for the system to cool down before disassembly. Severe burns and injury will occur if skin comes into contact with a hot exhaust system.

STEP 1

To begin your AWE system install you will start by removing the factory covers, and braces.

1. Remove the fasteners that hold in the covers shown at **(A)** in **Figure 1**. Then remove the covers.
2. Remove the 5 OE bolts from the chassis brace, and hanger shown at **(B)**. Then remove the brace, and hanger.
3. Remove the 8 OE bolts from the chassis brace shown at **(C)**. Then remove the brace.
4. Remove the 2 fasteners shown at **(D)** allowing the cover to hang from the front fasteners.

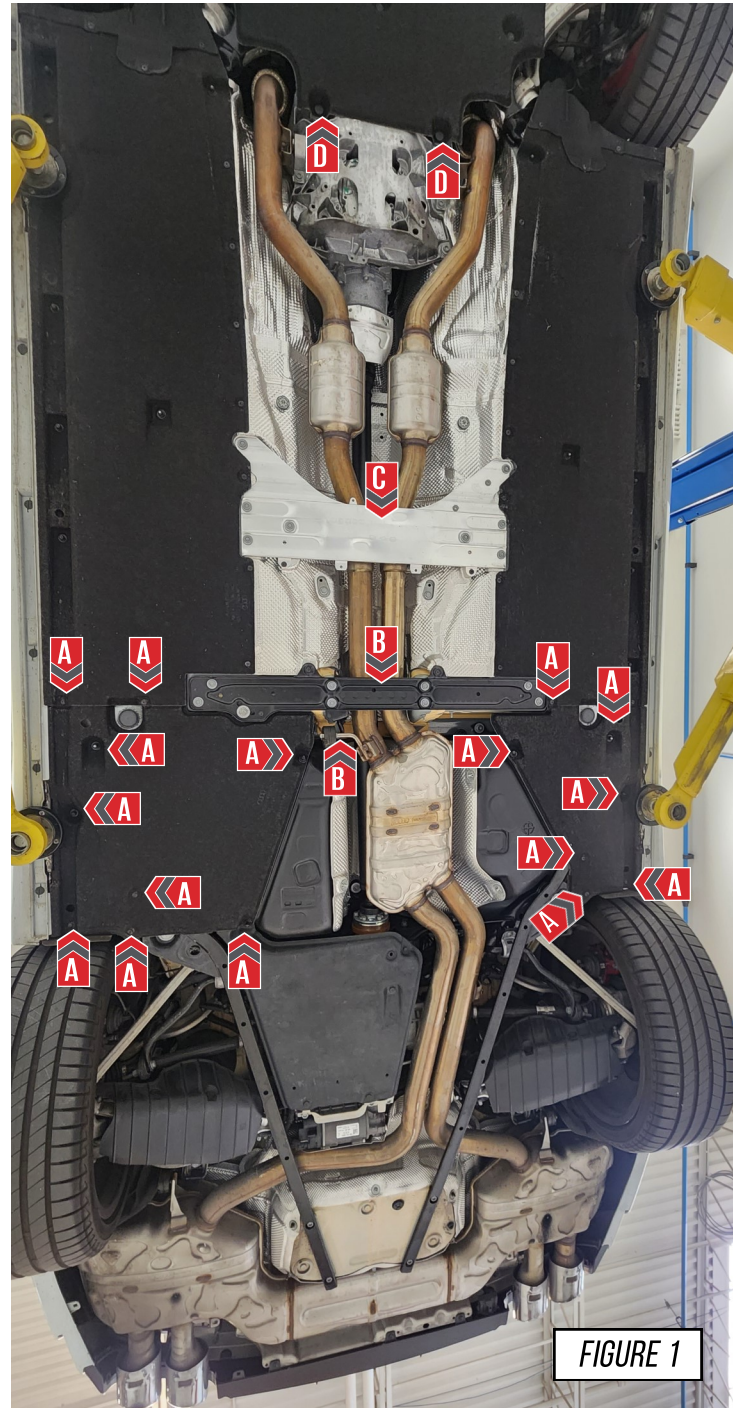

STEP 2

Using a pole jack, support the rear subframe of the vehicle close to the subframe bolt shown at (A) in **Figure 2-1**.

With the subframe bolt removed, remove the chassis brace, shown at (B) in **Figure 2-2**.

With the chassis brace removed reinstall the subframe bolt, and remove the pole jack.

 **Do not try to remove the subframe bolt without having a pole jack supporting the subframe.**

 **Do not move the pole jack until the subframe bolt has been reinstalled.**

Note: The braces will be reinstalled at the end of the installation

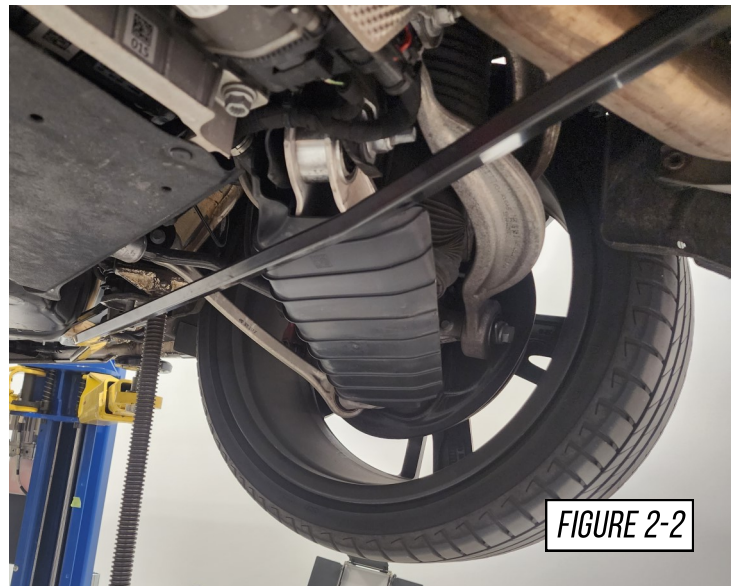
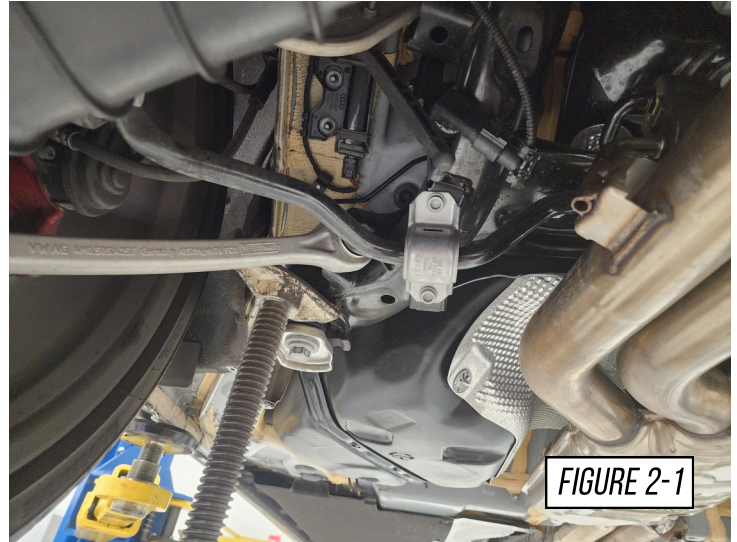

STEP 3

Continue by removing the OE dual exit exhaust by following the steps, shown in **Figure 2**.

 **Soak all bolts and rubber hangers in penetrating oil before starting any work.**

 **Support the mid muffler with a pole jack to ease the removal of the OE exhaust system.**

1. Loosen the two clamps shown at **(A)**, and move them away from the joint
2. Remove the hanger bars from the OE rubber hangers shown at **(B)**.
3. Unplug the OE valves on the top side of the mufflers marked at **(C)**.
4. Remove the rear section of the exhaust system.
5. Remove the OE downpipe hardware, and hangers shown at **(D)**. There will be 3 nuts per side that need to be removed with the hardware removed you can now remove the downpipes.

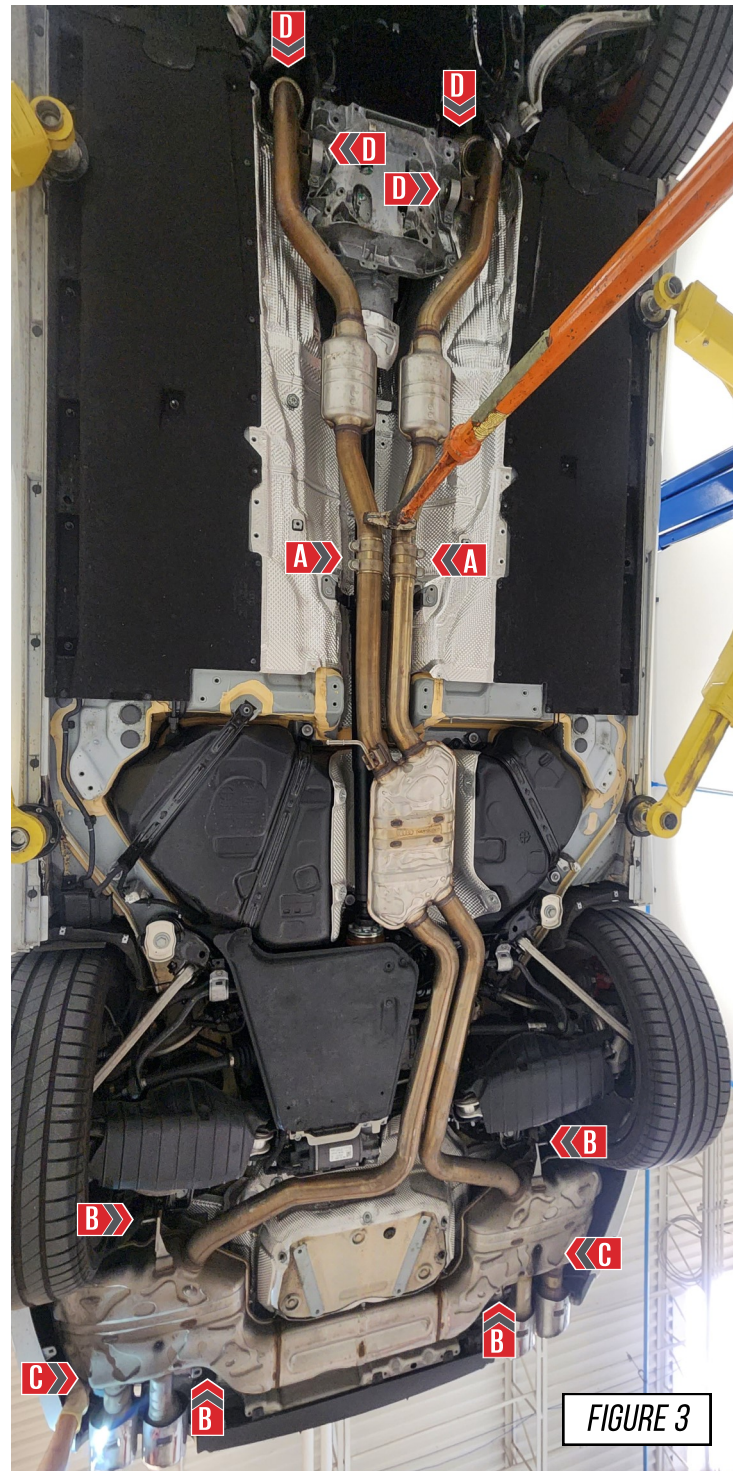
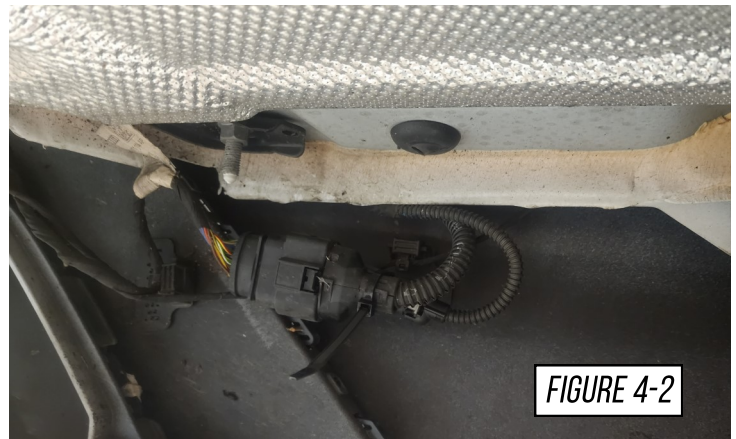

FIGURE 3

STEP 4

Begin your installation by installing your AWE electronic valve simulators. Plug the valve simulator into the OE harness, as shown in **Figure 4-1**. Next secure the valve simulator and harness secure and out of the way as shown at **(A)** in **Figure 4-2**. Repeat for the opposite side of the vehicle.



STEP 5

Remove the OE hangers from both OE downpipes, as shown in **Figure 5**.



STEP 6

Begin installing your AWE driver side flex section (**D36**). Do this by first re-installing the OE downpipe gasket as shown in **Figure 6**.

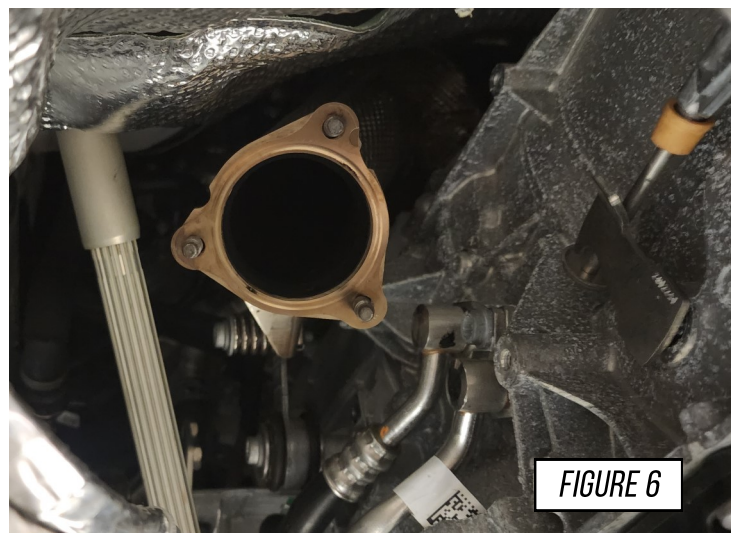

STEP 7

Next loosely secure your AWE driver side flex section (**D36**) at the flange with the provided hardware, as shown in **Figure 7**.

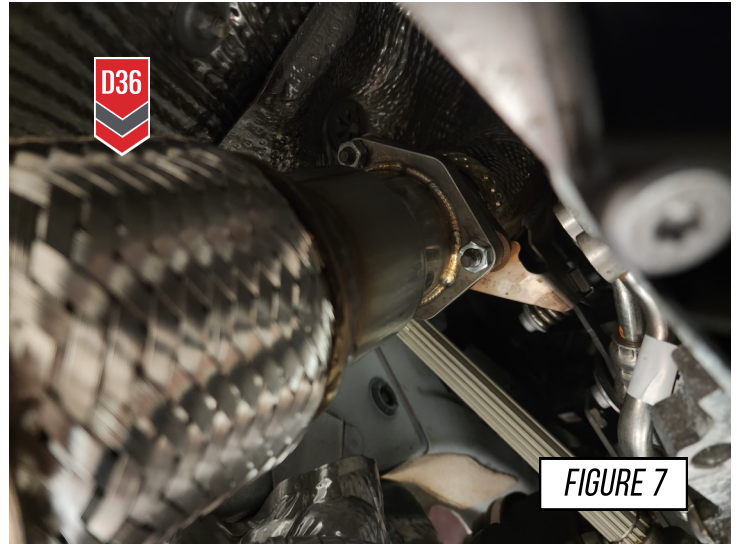

FIGURE 7

STEP 8

Slide the OE hanger onto the hanger bar as shown in **Figure 8-1**. Make sure the hanger lines up with the bolt holes.

Now evenly tighten down all three nuts on the studs.

After tightening the flange hardware fully make sure to reinstall the OE hardware on the hanger, as shown in **Figure 8-2**.

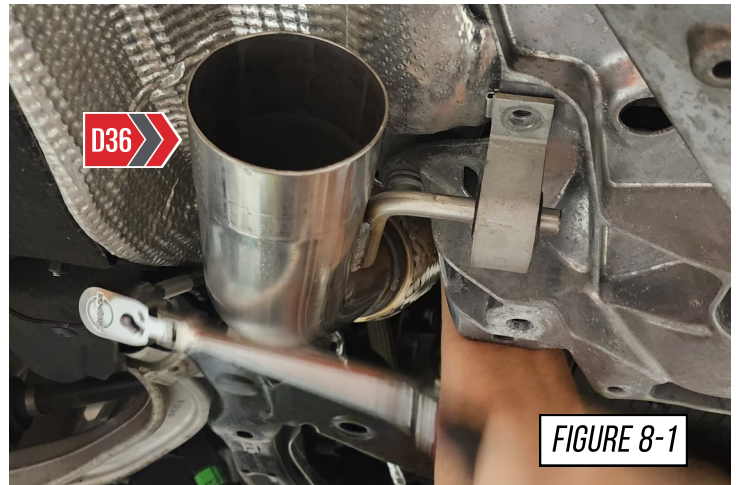

FIGURE 8-1



FIGURE 8-2

STEP 9

Next loosely secure your AWE passenger side flex section (D37) at the flange with the provided hardware, as shown in **Figure 9**.

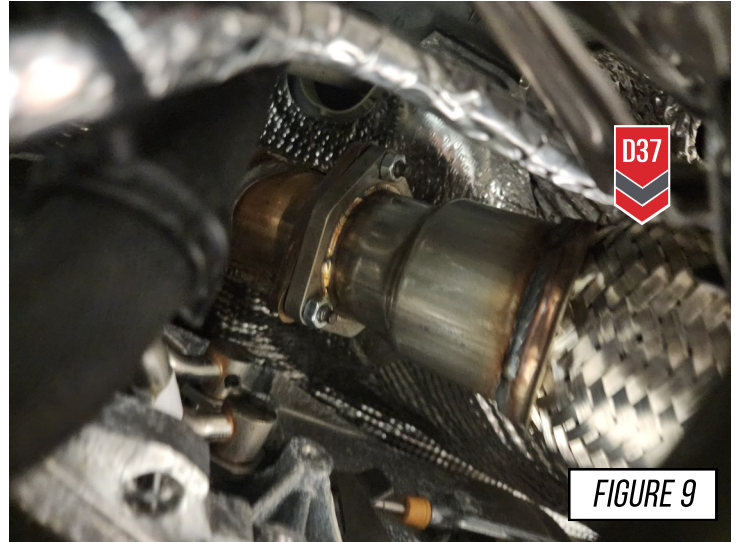

STEP 10

Slide the OE hanger onto the hanger bar as shown in **Figure 10-1**. Make sure the hanger lines up with the bolt holes.

Now evenly tighten down all three nuts on the studs.

After tightening the flange hardware fully make sure to reinstall the OE hardware on the hanger, as shown in **Figure 10-2**.

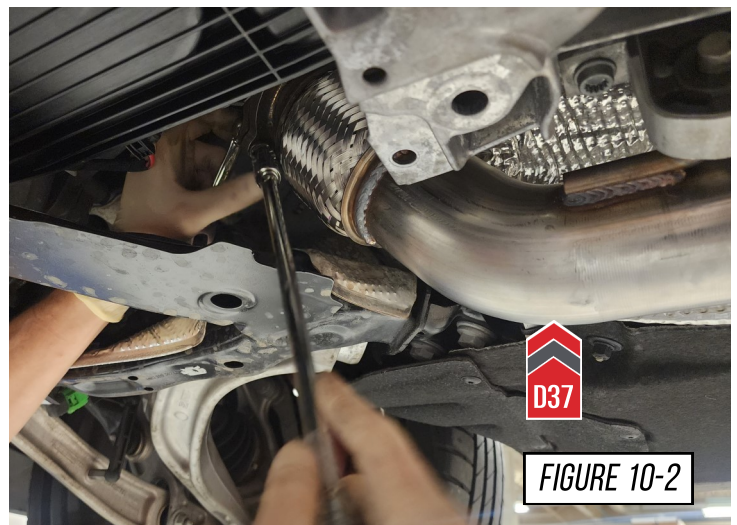
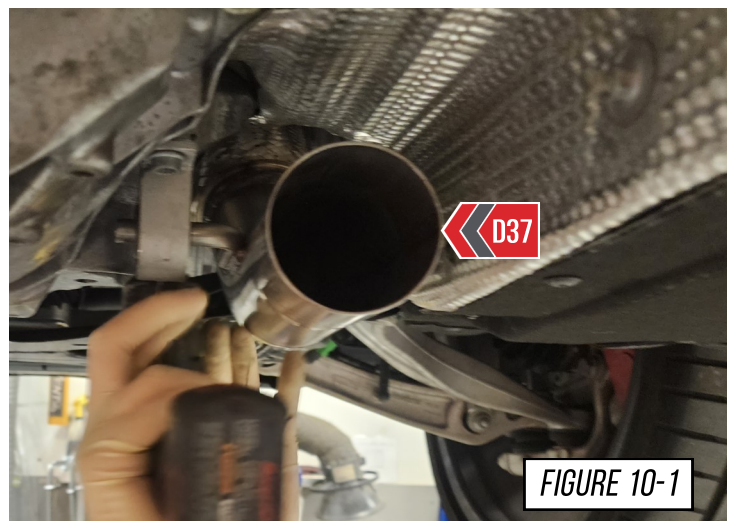

STEP 11

Gather your AWE mid section (**E90**) and two clamps, slide a clamp over each inlet section. Line up the inlets with the outlets of the flex sections (**D36**, **D37**). Slide the mid section onto the outlets and bottom out the slip fits. It is best to do this by pushing from the rear of the mid section, as shown in **Figure 11**.



STEP 12

Use a pole jack to support the AWE mid section (**E90**) as shown in **Figure 12**. After the mid section is supported reinstall the OE chassis brace shown at (**A**) in **Figure 12**.

With the chassis brace installed, adjust the height of the AWE mid section (**E90**) to ensure that there is proper clearance from the brace and the dual 3" tubes (**B**). This will help the rest of the installation to go smoothly.

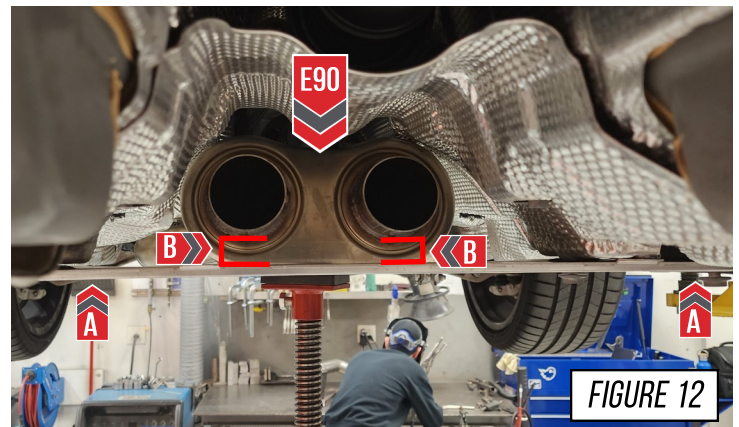

STEP 13

Install your AWE passenger side mid tube (**E92**), as shown in **Figure 13**. Slide a provided clamp over the expanded side. Bottom out the slip fit onto the AWE mid section (**E90**).

Snug the clamp but do not fully tighten at this time.

Note: The hanger bar will not be secured into a hanger at this time.



FIGURE 13

STEP 14

Install your AWE driver side mid tube (**E91**), as shown in **Figure 14-1**. Slide a provided clamp over the expanded side. Bottom out the slip fit onto the AWE mid section (**E90**).

Snug the clamp, but do not fully tighten at this time.

Note: The proper clearance from the chassis brace that was re-installed in step 11 can be seen here in **Figure 14-2**.



FIGURE 14-1

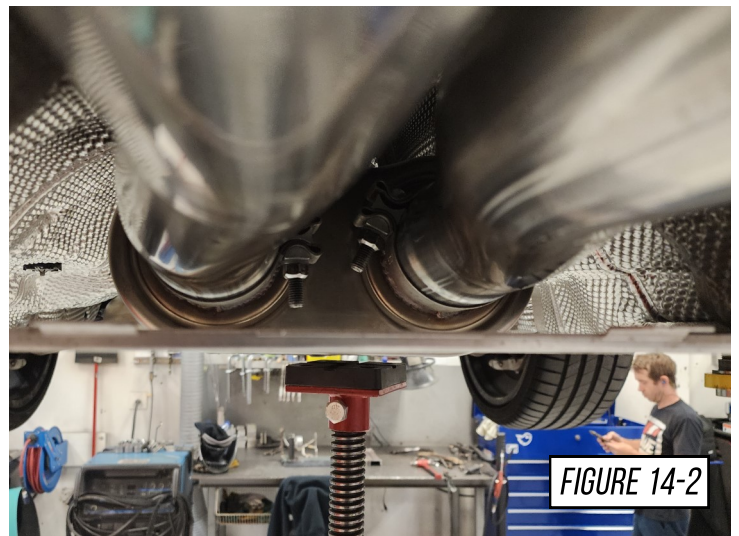
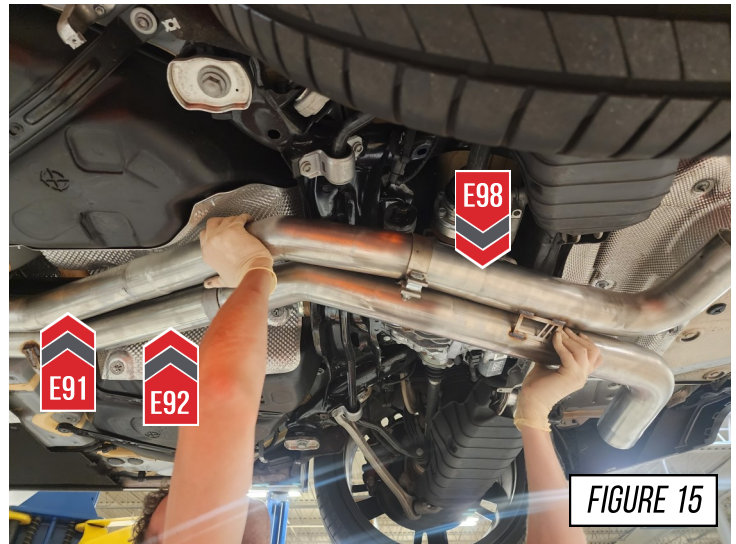

FIGURE 14-2

STEP 15

Install your AWE axle tube assembly (**E98**), as shown in **Figure 15**. Slide a provided clamp over the expanded side of each tube. Then align and bottom out the slip fits on each of the mid tubes (**E91, E92**).

Snug the clamps, but do not fully tighten at this time



STEP 16

Re-install the OE hanger onto the hanger bar on the passenger side mid tube (**E92**), as shown at (**A**) in **Figure 16-1**.

Now reinstall the OE chassis brace shown at (**B**) in **Figure 16-2**.

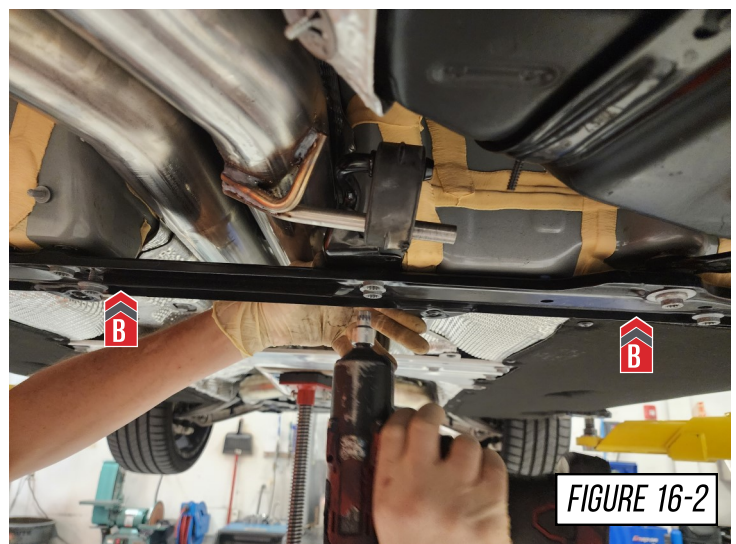
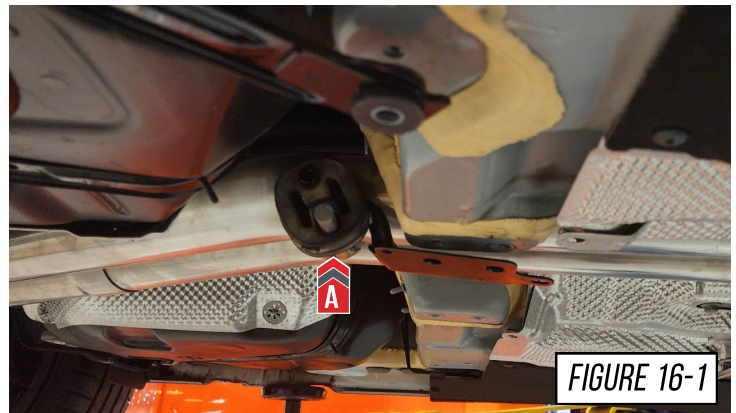

STEP 17

Use a pole jack to support the passenger side rear subframe of the car. Place the pole jack behind the sway bar as shown in **Figure 17-1**.

Remove the subframe bolt shown at **(A)** in **Figure 17-1**.

DO NOT REMOVE THE SUBFRAME BOLT WITHOUT A POLE JACK SUPPORTING THE SUBFRAME.



Reinstall the passenger side chassis brace as shown in **Figure 17-2**. After all hardware is reinstalled you can remove the pole jack.

Repeat these steps for the driver side chassis brace.

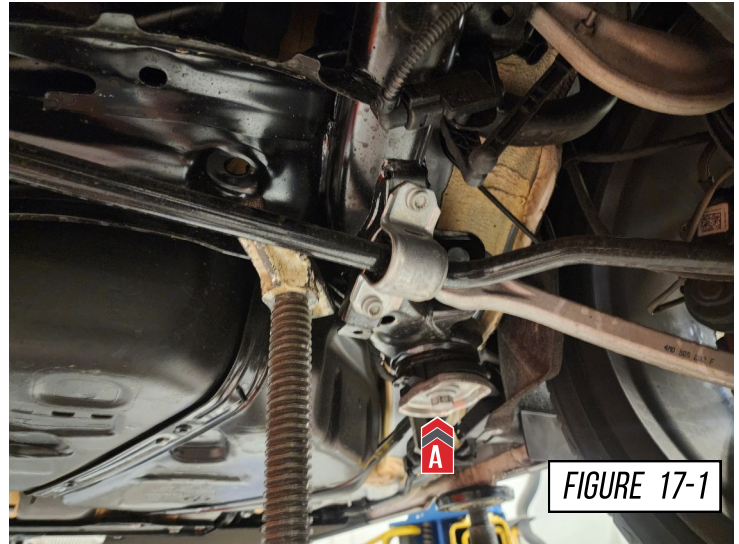

FIGURE 17-1



FIGURE 17-2

STEP 18

Re-install the OE rear driver side hanger, as shown at **(A)** in **Figure 18-1**. Then re-install the OE passenger side hanger, as shown at **(B)** in **Figure 18-2**.



FIGURE 18-1

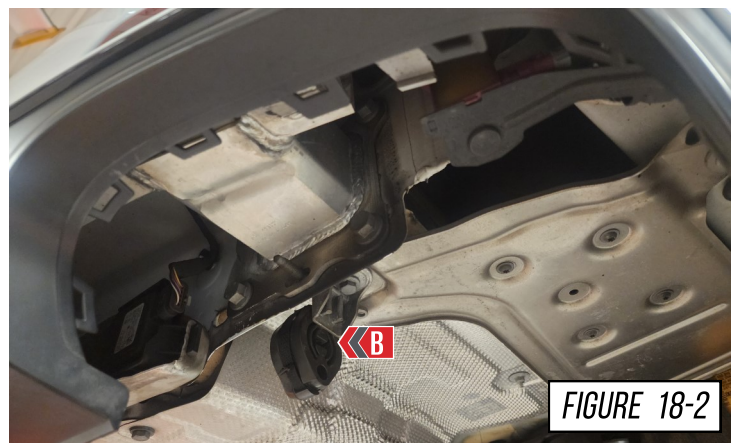

FIGURE 18-2



IF INSTALLING THE TOURING EXHAUST SYSTEM, SKIP TO STEP 21



STEP 19

TRACK SYSTEMS ONLY

Install your AWE driver side rear track section (**D44**) Do this by first sliding a provided clamp over the expanded joint.

Next slide the hanger bar into the forward most hanger, as shown at **(A)** in **Figure 19**.

Then bottom out the slip fit on the AWE axle tube assembly (**E98**), as shown at **(B)** in **Figure 18**.

Lastly slide the hanger bar into the rear most hanger, as shown at **(C)** in **Figure 19**.

Snug the clamp but do not fully tighten it at this time.

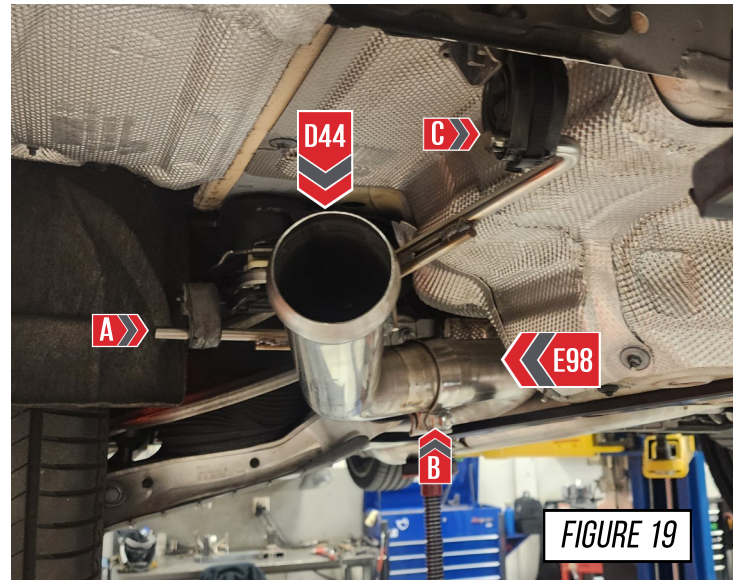

FIGURE 19

STEP 20

TRACK SYSTEMS ONLY

Install your AWE passenger side rear track section (**D45**) Do this by first sliding a provided clamp over the expanded joint.

Next slide the hanger bar into the forward most hanger, as shown at **(A)** in **Figure 20**.

Then bottom out the slip fit on the AWE axle tube assembly (**E98**), as shown at **(B)** in **Figure 20**.

Lastly slide the hanger bar into the rear most hanger, as shown at **(C)** in **Figure 20**.

Snug the clamp but do not fully tighten it at this time.

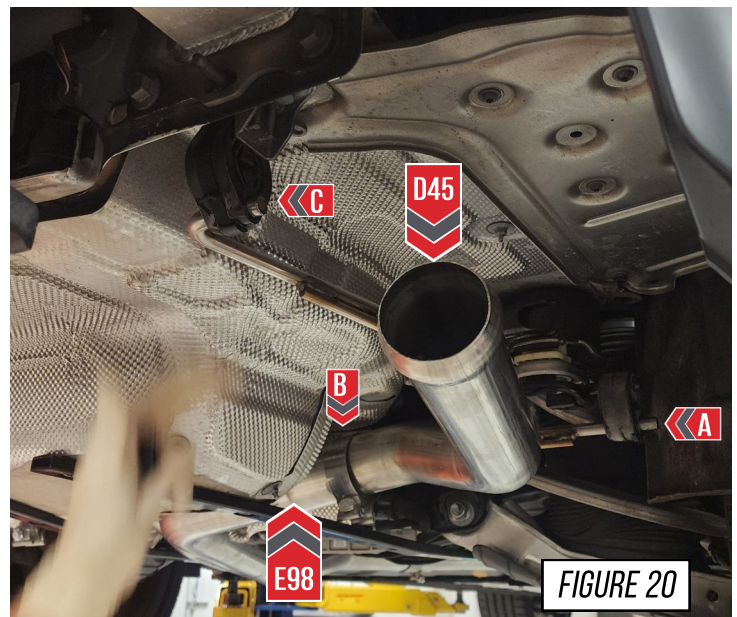

FIGURE 20



IF INSTALLING A TRACK EXHAUST SYSTEM, SKIP TO STEP 22



STEP 21

TOURING SYSTEMS ONLY

Install your AWE driver side rear track section (**D42**) Do this by first sliding a provided clamp over the expanded joint.

Next slide the hanger bar into the forward most hanger, as shown at (**A**) in **Figure 21-1**.

Then bottom out the slip fit on the AWE axle tube assembly (**E98**), as shown at (**B**) in **Figure 21-2**.

Lastly slide the hanger bar into the rear most hanger, as shown at (**C**) in **Figure 21-2**.

Snug the clamp but do not fully tighten it at this time.

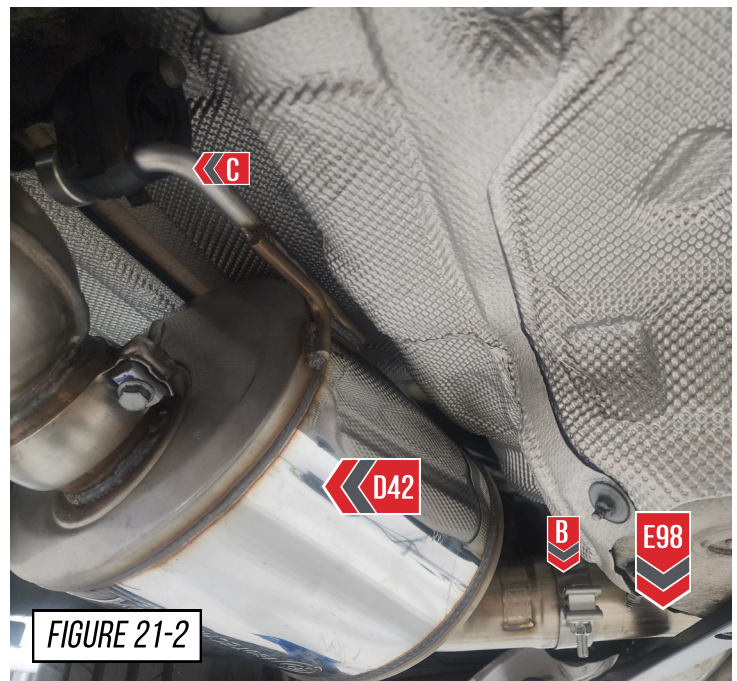
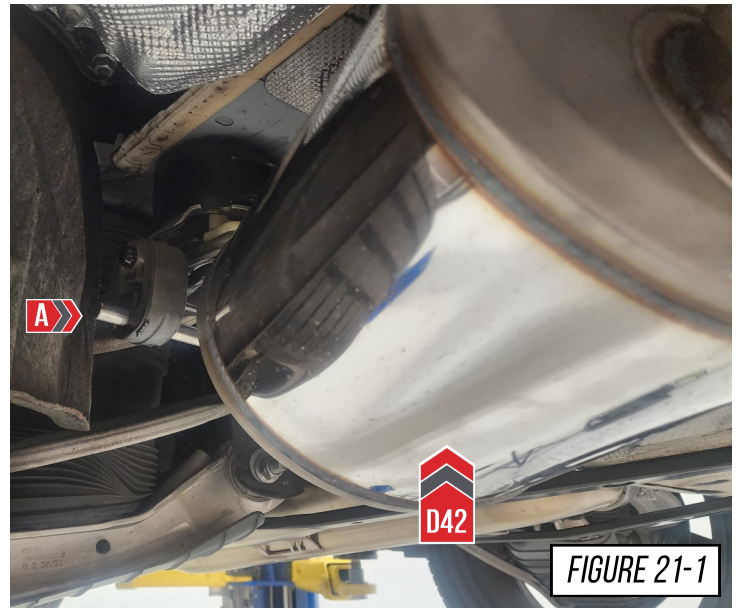

STEP 22

Install your AWE driver side tip section (**D46**), using the provided barrel clamps, as shown in **Figure 22-1**.

It is helpful to have someone align, and hold the tip section while you tighten the barrel clamp.

Repeat this process for the AWE passenger side tip section (**D47**), as shown in **Figure 22-2**

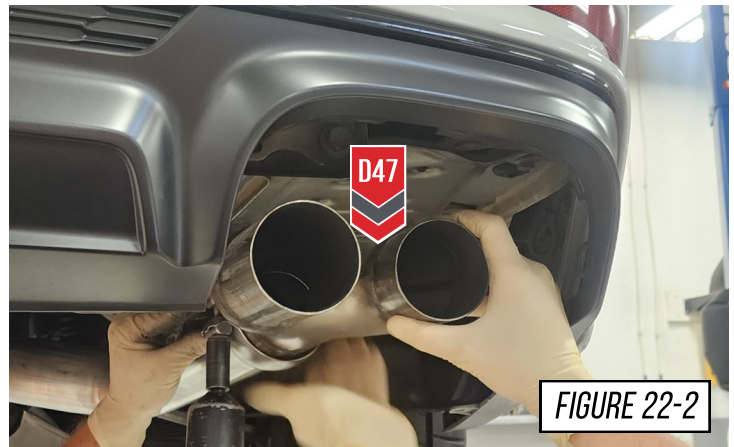

STEP 23

It is crucial to install each section and exhaust band clamps correctly to prevent loose joints, exhaust leaks and rattles.

Arrow A shows the expanded pipe and the preinstalled exhaust clamp being brought up to the corresponding pipe.

Arrow B shows the overlapping pipe installed correctly over the corresponding pipe.

Arrow C shows the exhaust band clamp being brought to the edge of the expanded pipe.



NOTES:

- **Do not** fully torque any exhaust clamp until the entire exhaust has been installed and adjusted.
- Torque specification is a **minimum** of 60 ft/lbs

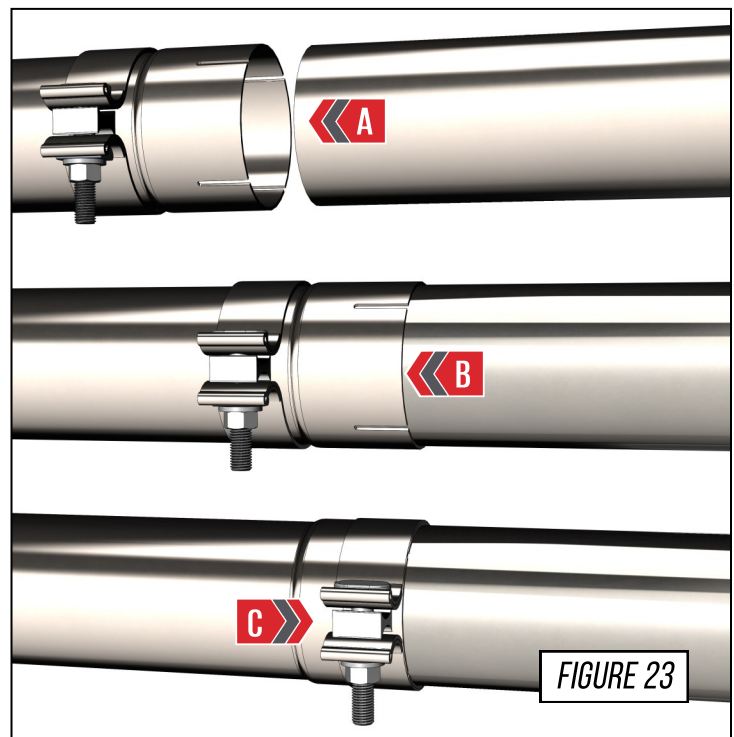

STEP 24

To install the exhaust tips with integrated clamps, first, attach the exhaust tip in the proper orientation onto the exhaust outlet tube.

Insert one of the carriage bolts from the hardware kit (**3910-41010**) through the tab on the exhaust tip and thread on one of the corresponding nuts.

Using anti-seize on the bolt threads will help installation and prevent breakage of hardware.

 If exhaust system only has 2 exhaust tips while the integrated clamp kit has enough hardware for our 4 tip exhaust systems. You will have 2 sets of hardware left over that will not be used.

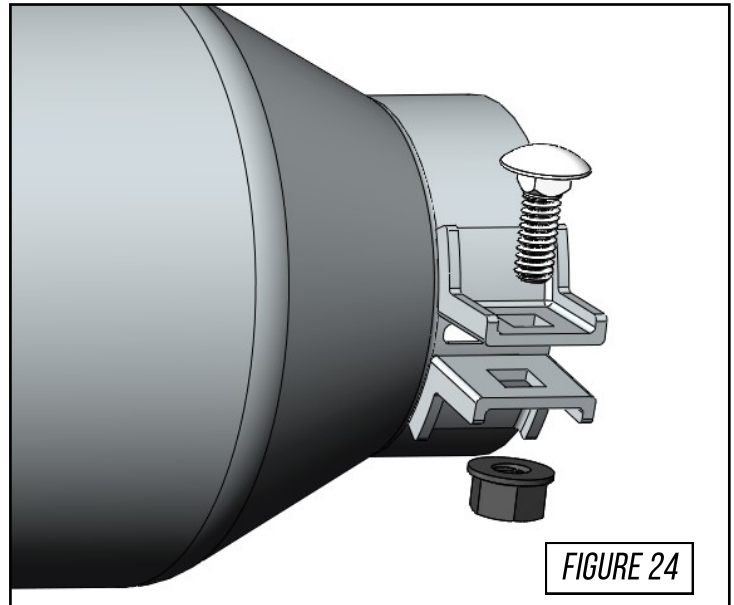

STEP 25

Install all 4 AWE exhaust tips onto the tip outlets with the provided hardware as shown in **Figure 25**.

Note: When installing tips be careful not to damage the rear valance.



STEP 26

Install your AWE lock collar clamps on the rear most hanger bars on both sides of the vehicle, as shown in **Figure 26-1**, and **Figure 26-2**. Install the clamps flush with the end of the hanger bar.

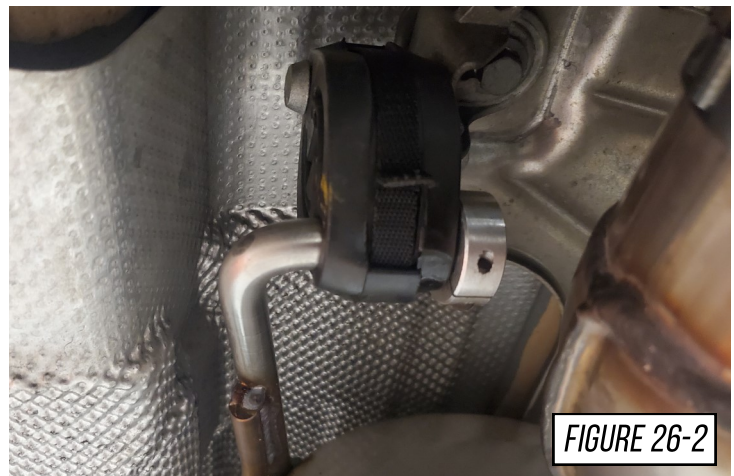
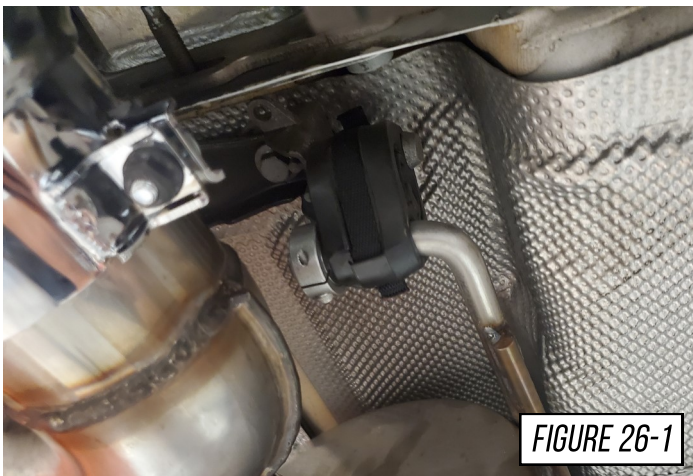

STEP 27

Make your final adjustments to the tips to ensure they are in a position you like. Once the desired position is achieved work from the front of the car to the back, tightening all the clamps fully, and ensuring there is proper clearance of the chassis, and braces

It is now recommended to drive the car to allow the exhaust to heat cycle after all clamps and tips are fully tightened.



At this point the exhaust will be **very hot**, allow time to cool before work continues.

Check the tips for correct alignment, adjust as needed.



Don't forget to see the last page for any trouble shooting needs!



ENJOY!



TROUBLESHOOTING

Issue	Solution
Exhaust is not fitting correctly	Most fitment issues are due to improperly adjusted exhaust. This includes tip fitments and rattling due to chassis contact. Check out our fitment guide for more installation tips.
Incorrect or missing parts	Double check the parts list for your system and compare them with what you received. Fill out our contact form, found below and let us know what parts you need.

CARE

Once installed properly, your AWE exhaust will provide years of trouble-free performance.

The exhaust volume and sound will settle with usage; 800-1000 miles is required to break-in new exhaust systems.

Also, please note that the rear **180Technology**® resonator has a small drain hole to allow condensation to escape. Water drops from this area are normal.

Periodic cleaning of exhaust tips is necessary to maintain proper finish, especially in areas prone to road salt and caustic deicing solutions. Use a mild soap and water solution or car wax to clean the finish. Avoid using abrasive polishes, as they can scratch the finish.

Any questions or comments,
please do not hesitate to contact us:

AWE
[CONTACT FORM](#)

WARRANTY

Up-to-date warranty information is found [HERE](#).