



INSTALLATION GUIDE: AWE EXHAUST SUITE FOR THE TOYOTA GR COROLLA

For up-to-date fitment information, please visit the product page on [AWE-Tuning.com](https://www.awe-tuning.com).

THIS GUIDE IS INTENDED FOR THE FOLLOWING PART NUMBERS:

- 3020-53472 AWE Track Edition Exhaust for GR Corolla - Diamond Black Tips
- 3015-53472 AWE Touring Edition Exhaust for GR Corolla - Diamond Black Tips
- 3020-11472 AWE Touring-to-Track Conversion Kit for GR Corolla
- 3015-11472 AWE Track-to-Touring Conversion Kit for GR Corolla

Welcome to the AWE family, and congratulations on your purchase of the AWE Exhaust System for the GR Corolla.

Exquisite build quality and craftsmanship, coupled with industry leading performance, distinguish this exhaust system from all others.

*For up to the minute fitment information, be sure to visit the AWE website. As always, AWE Performance Specialists are standing by for any questions, [right here](#).

PARTS LIST (TRACK)



Inspect **ALL** parts prior to disassembly of vehicle; If damaged or **MISSING**, please contact the place of purchase immediately.

Symbol	Part Number	Description	QTY
	F79	GR Corolla Track Front Section	1
	F81	GR Corolla Center pipe	1
	F82	GR Corolla DS Tip Section	1
	F83	GR Corolla PS Tip Section	1
A >>	180007	5.00" OD x 3.00" ID, Slash Cut, Diamond Black, AWE logo, Integrated Clamp	2
B >>	180031	8.00" OD Oval 3.00" Inlet , Slash Cut, Diamond Black, AWE Tuning Logo, Integrated Clamp	1
C >>	3910-41010	**Only takes 1 of these kits per set of 2 or 4 tips** YELLOW Hardware Kit for Integrated Clamp Style Exhaust Tips - Quad	1
D >>	180250	AWE 2.5" Band clamp, stainless	2
E >>	180300	AWE 3.0" Band Clamp, Stainless	1
F >>	3910-11012	AWE 1/2" Split Collar Clamp Kit	1
G >>	91287A137	Metric 18-8 SS Hex Head Cap Screw M6	3
H >>	93475A250	Metric DIN 125 18-8 SS Flat Washer M6	3
I >>	95735A113	M10 x 1.25 mm Thread, 100 mm Long JIS High-Strength Steel Flanged Hex Head Screw	2

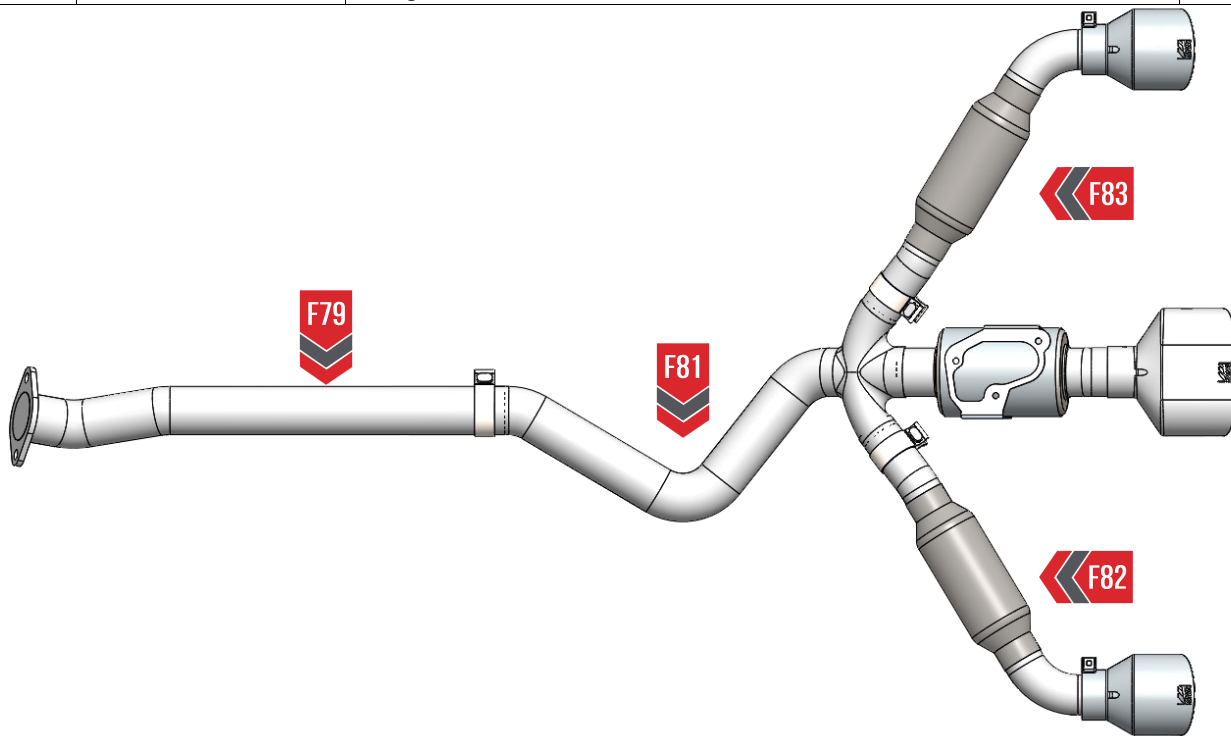

PARTS LIST (TOURING)



Inspect **ALL** parts prior to disassembly of vehicle; If damaged or **MISSING**, please contact the place of purchase immediately.

Symbol	Part Number	Description	QTY
	F80	GR Corolla Touring Front Section	1
	F81	GR Corolla Center pipe	1
	F82	GR Corolla DS Tip Section	1
	F83	GR Corolla PS Tip Section	1
A >>	180007	5.00" OD x 3.00" ID, Slash Cut, Diamond Black, AWE logo, Integrated Clamp	2
B >>	180031	8.00" OD Oval 3.00" Inlet , Slash Cut, Diamond Black, AWE Tuning Logo, Integrated Clamp	1
C >>	3910-41010	**Only takes 1 of these kits per set of 2 or 4 tips** YELLOW Hardware Kit for Integrated Clamp Style Exhaust Tips - Quad	1
D >>	180250	AWE 2.5" Band clamp, stainless	2
E >>	180300	AWE 3.0" Band Clamp, Stainless	1
F >>	3910-11012	AWE 1/2" Split Collar Clamp Kit	1
G >>	91287A137	Metric 18-8 SS Hex Head Cap Screw M6	3
H >>	93475A250	Metric DIN 125 18-8 SS Flat Washer M6	3
I >>	95735A113	M10 x 1.25 mm Thread, 100 mm Long JIS High-Strength Steel Flanged Hex Head Screw	2

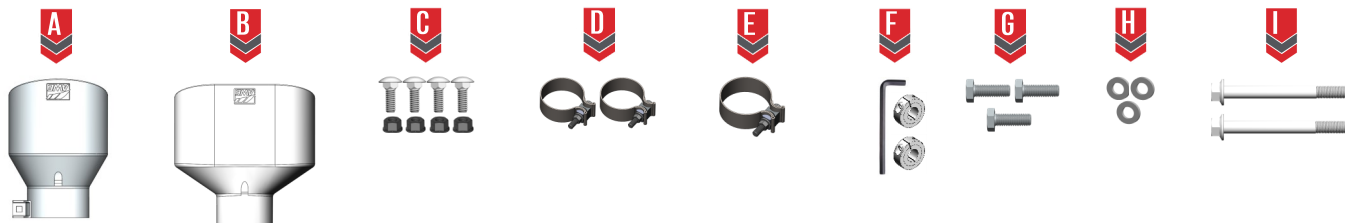
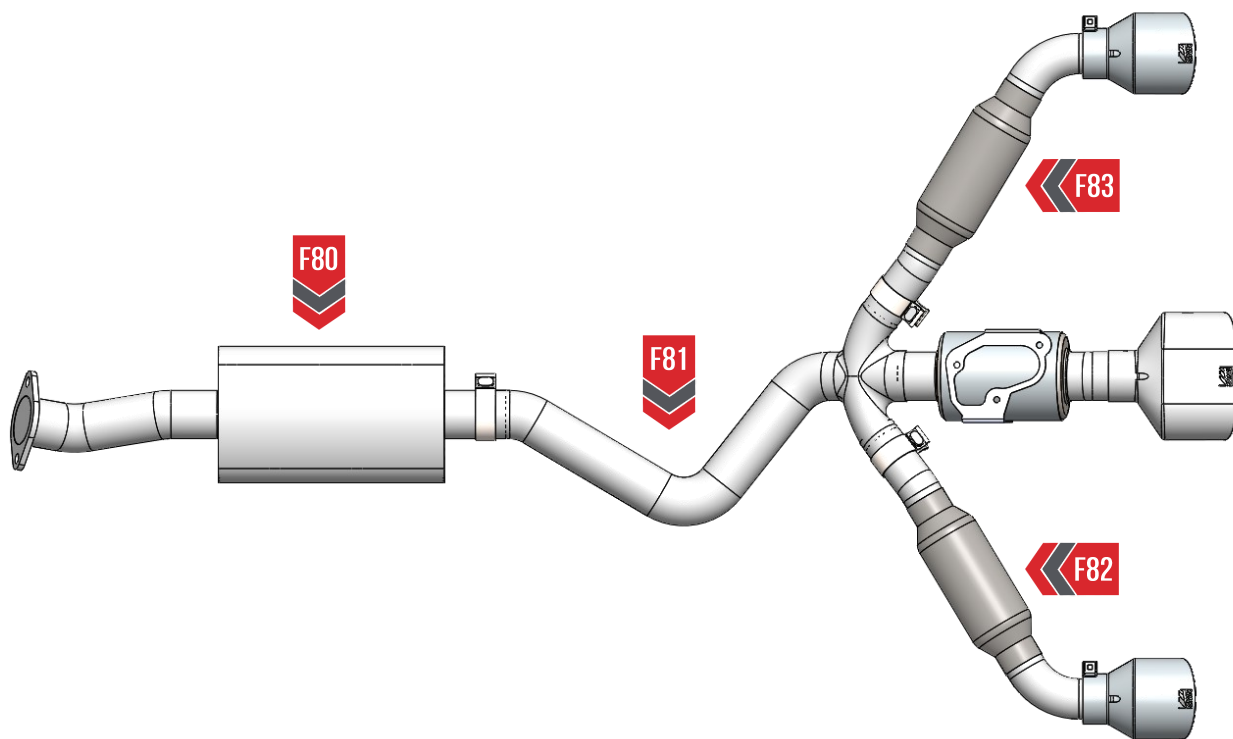



NOTE: Always refer to the manufacturer's service manual for precise torque specifications on all OEM fasteners.



CAUTION: The exhaust may be **VERY HOT** — allow adequate time for the system to cool down before disassembly. Severe burns and injury will occur if skin comes into contact with a hot exhaust system.

STEP 1

Start by removing the OE exhaust system, by following these steps.

- A) Unplug the OE valve motor.
- B) Remove the hardware at the flange.
- C) Detach the 4 OE rubber hangers.
- D) Remove the stock exhaust.

Note: All rubber hangers will be reused with your AWE exhaust.

Note: The flange springs will be reused with your AWE exhaust.

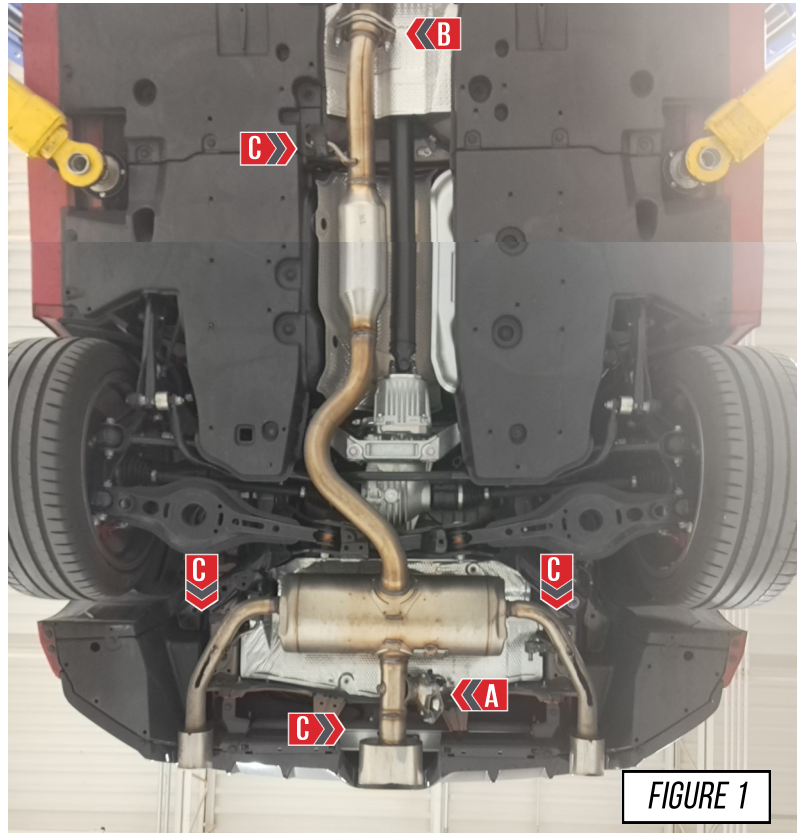

STEP 2

Remove the OE valve motor and bracket from the rear of the OE exhaust, as shown at **(A)** in **Figure 2**. Do this by **ONLY** removing the three larger bolts on the perimeter of the valve assembly.

Note: Do not remove the OE valve motor from the OE mounting bracket, as both pieces will be installed with your AWE exhaust system

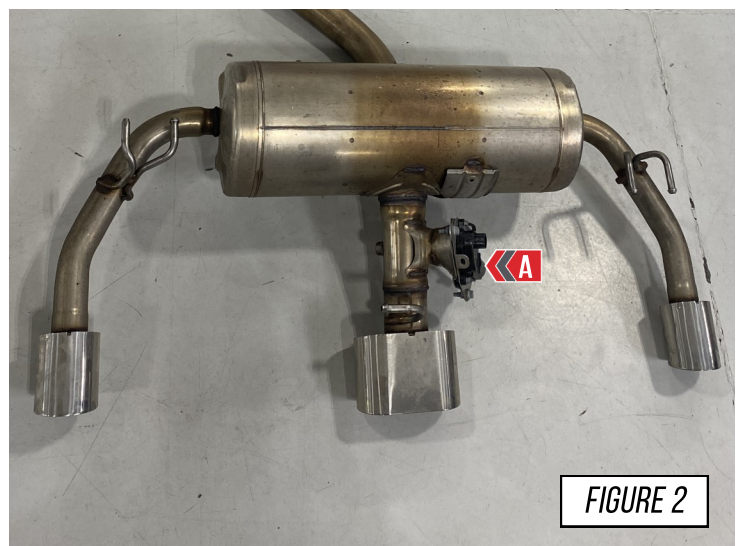

STEP 3

Gather your AWE front section (**F79** or **F80**), the OE flange springs and supplied bolts (**A**) and the OE front rubber hanger (**B**), as shown in **Figure 3**.

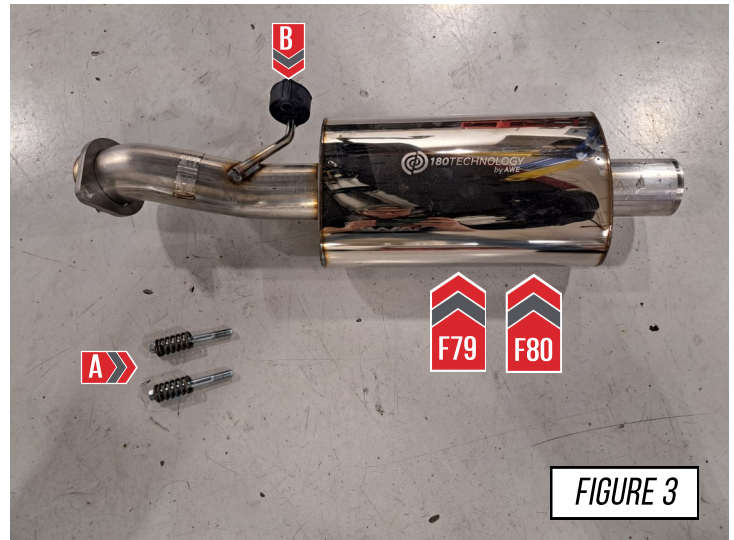

STEP 4

Install your AWE front section by loosely securing the flange bolts (**A**) and reinstall the rubber front hanger (**B**), as shown in **Figure 4**.

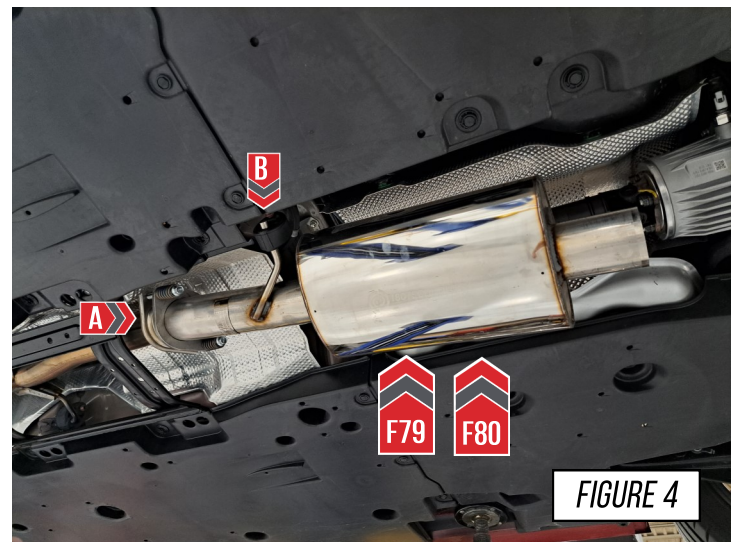

STEP 5

Using the provided hardware secure the OE valve motor, to your AWE center section (**F81**), as shown in **Figure 5**.

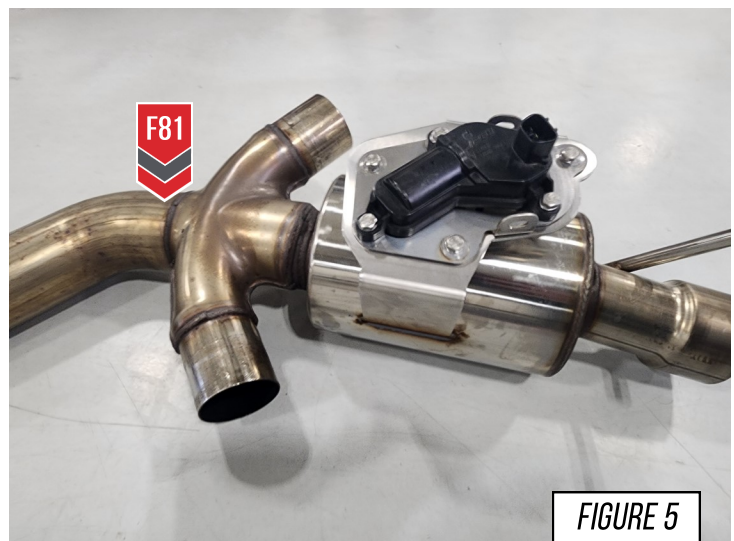

STEP 6

It is crucial to install each section and exhaust band clamps correctly to prevent loose joints, exhaust leaks and rattles.

Arrow A shows the expanded pipe and the preinstalled exhaust clamp being brought up to the corresponding pipe.

Arrow B shows the overlapping pipe installed correctly over the corresponding pipe.

Arrow C shows the exhaust band clamp being brought to the edge of the expanded pipe.



NOTES:

- **Do not** fully torque any exhaust clamp until the entire exhaust has been installed and adjusted.
- Torque specification is a **minimum** of 60 ft/lbs

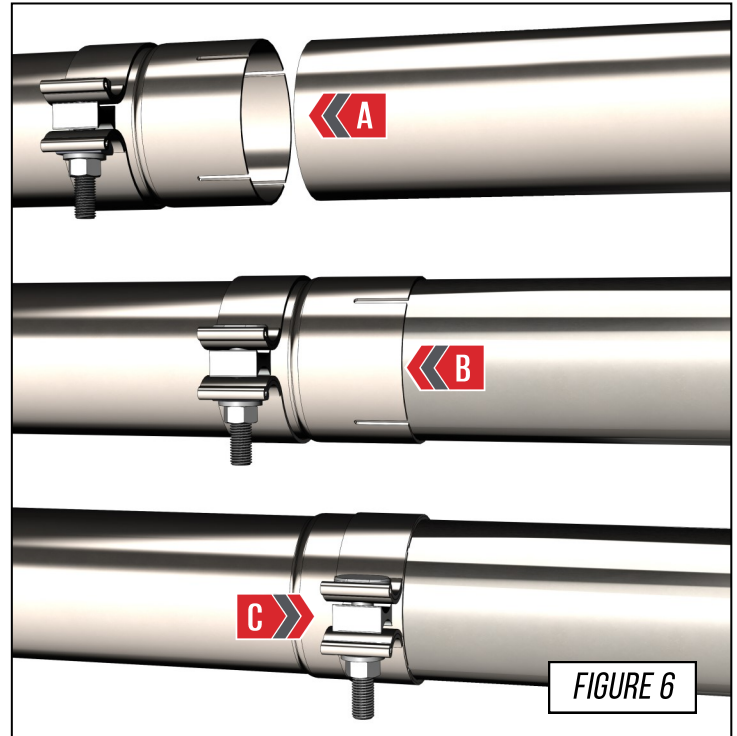

STEP 7

Install your AWE center section (**F81**) by first bottoming out the slip fit on your AWE front section (**F79/F80**) and reusing the OE rear rubber hanger (**A**), as shown in **Figure 7**.

Next plug the OE valve back into the car, as shown at (**B**).

Note: Do not fully tighten clamp until end.

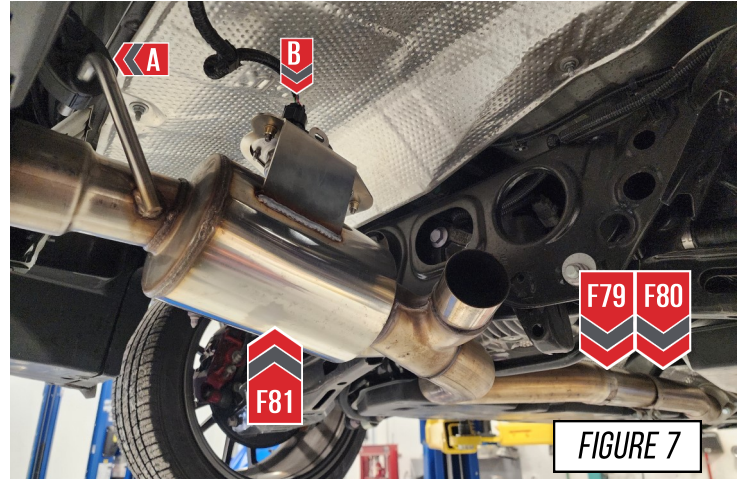

STEP 8

Gather the driver side tip section (**F82**), the 2.5in clamp (**180250**) and the hanger clamp kit (**3910-11012**).

Install the F82 tube using the provided clamp (**A**), and install the 2 hanger clamps onto the inside and outside of the outer hanger (**B**), as shown in **Figure 8-1** and **Figure 8-2**.

Note: Do not fully tighten clamp until end.

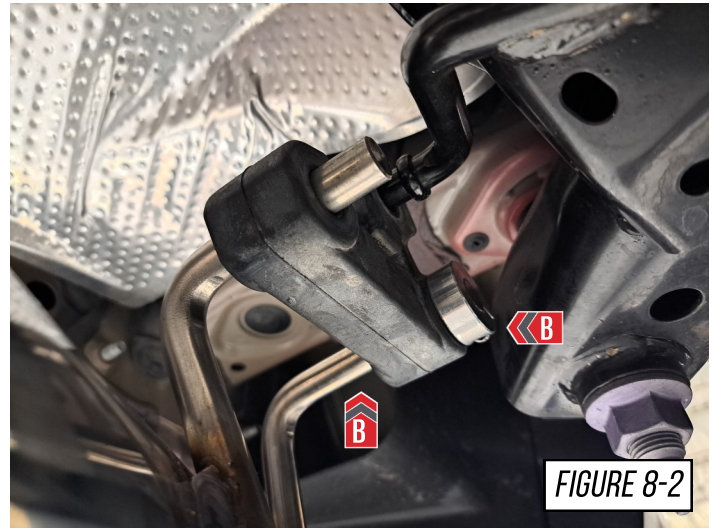
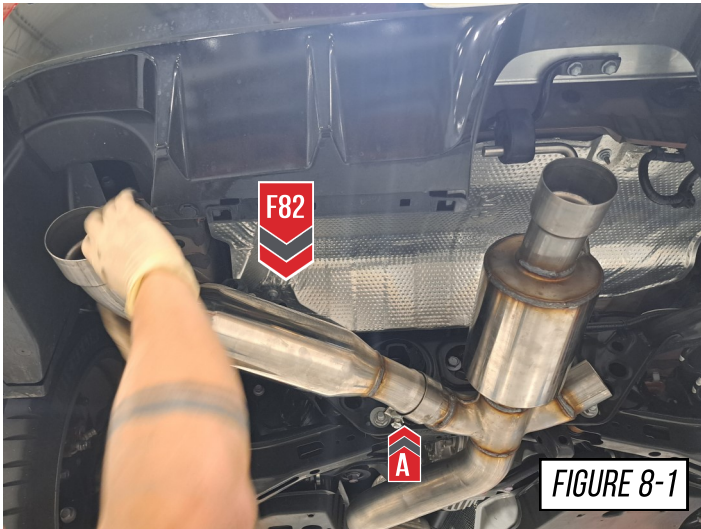

STEP 9

Install your AWE Passenger side tip section (**F83**) using a provided 2.5in clamp (**A**) and reusing the OE rear rubber hanger (**B**), as shown in **Figure 9**.

Note: Ensure the rubber hanger is fully sitting on the OE hanger bar. Do this by pushing the rubber hanger all the way on the OE hanger bar until it hits the stop on the bar.

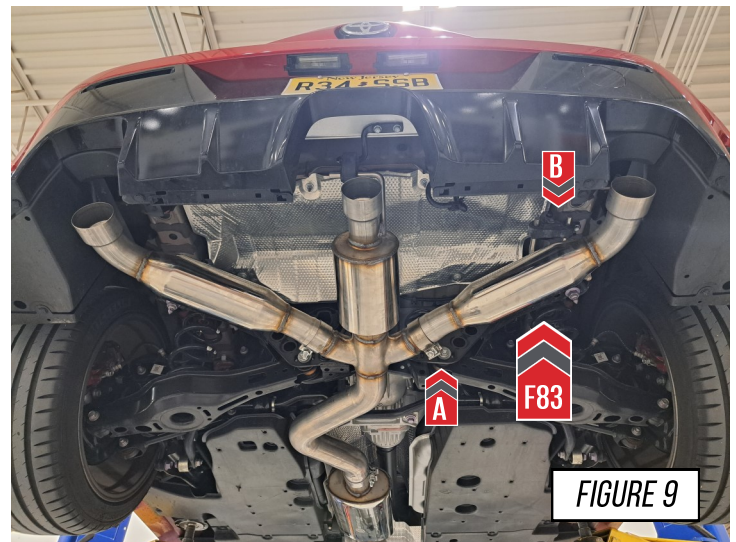

STEP 10

To install the exhaust tips with integrated clamps, first, attach the exhaust tip in the proper orientation onto the exhaust outlet tube.

Insert one of the carriage bolts from the hardware kit (**3910-41010**) through the tab on the exhaust tip and thread on one of the corresponding nuts.

Using anti-seize on the bolt threads will help installation and prevent breakage of hardware.

 If exhaust system only has 2 exhaust tips while the integrated clamp kit has enough hardware for our 4 tip exhaust systems. You will have 2 sets of hardware left over that will not be used.

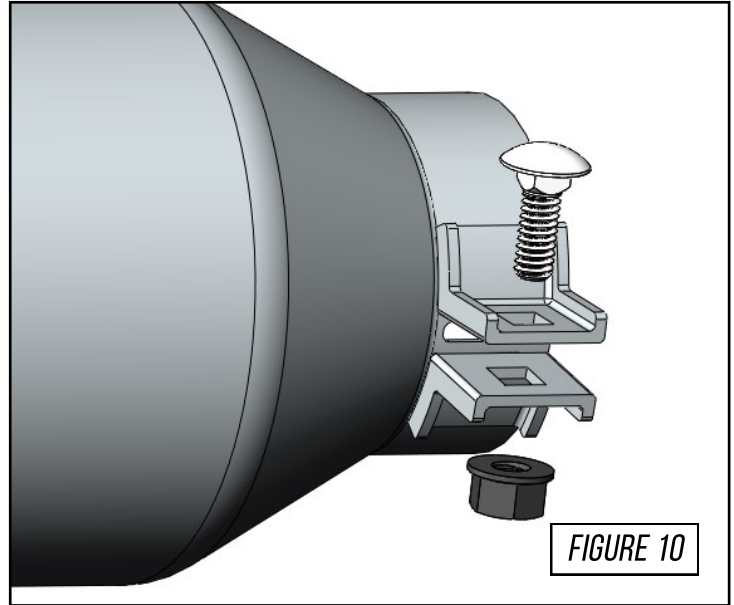

STEP 11

Gather the 3 exhaust tips (**180007 / 180031**) and the clamp kit (**3910-41010**), as shown in **Figure 11**.

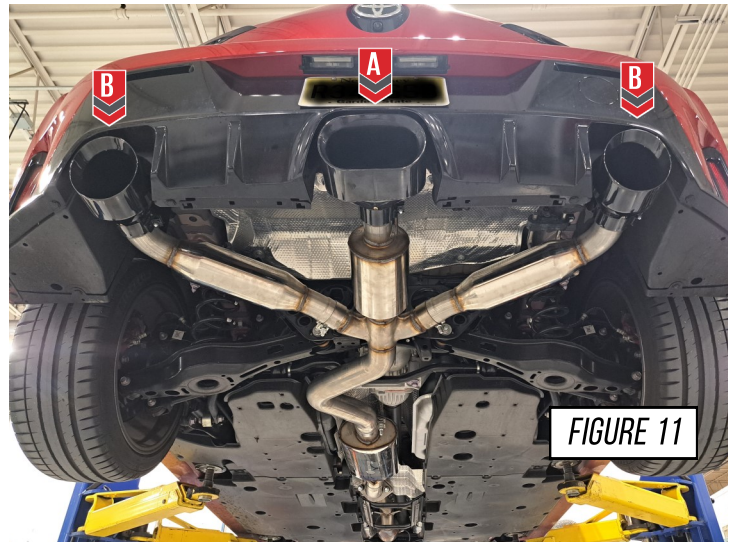

STEP 12

Tighten the 2 front flange bolts until the threads are bottomed out, as shown in **Figure 12**.

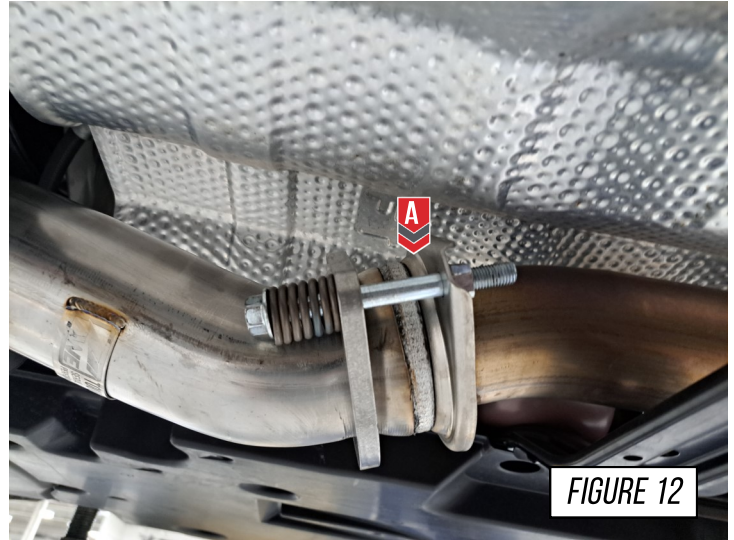



FIGURE 12

STEP 13

Make your final adjustments to the tips to ensure they are in a position you like. Once the desired positioning is achieved, fully tighten down all clamps.

It is now recommended to drive the car to allow the exhaust to heat cycle after all clamps and tips are fully tightened.

 At this point the exhaust will be very hot, allow to cool before work continues.

Check the tips for correct alignment, adjust as needed.

 Don't forget to see the next page for any troubleshooting needs!



FIGURE 13

ENJOY!



TROUBLESHOOTING

Issue	Solution
Exhaust is not fitting correctly	Most fitment issues are due to improperly adjusted exhaust. This includes tip fitments and rattling due to chassis contact. Check out our FAQ/ fitment guide for more installation tips.
Incorrect or missing parts	Double check the parts list for your system and compare them with what you received. Fill out our contact form, found below and let us know what parts you need.

CARE

Once installed properly, your AWE exhaust will provide years of trouble-free performance.

The exhaust volume and sound will settle with usage; 800-1000 miles is required to break-in new exhaust systems.

Also, please note that the rear **180Technology**® resonator has a small drain hole to allow condensation to escape. Water drops from this area are normal.

Periodic cleaning of exhaust tips is necessary to maintain proper finish, especially in areas prone to road salt and caustic deicing solutions. Use a mild soap and water solution or car wax to clean the finish. Avoid using abrasive polishes, as they can scratch the finish. For best results, we recommend [AWE's Fantastic Tip Tonic](#).

Any questions or comments,
please do not hesitate to contact us:

AWE
CONTACT FORM

WARRANTY

Up-to-date warranty information is found [HERE](#).