



INSTALLATION GUIDE: AWE C8 CORVETTE Z06 SWITCHPATH EXHAUST

For up-to-date fitment information, please visit the product page on [AWE-Tuning.com](https://www.awe-tuning.com).

THIS GUIDE IS INTENDED FOR THE FOLLOWING PART NUMBERS:

3025-43906 AWE SwitchPath™ Exhaust for C8 Corvette Z06 - Diamond Black Tips

Welcome to the AWE family, and congratulations on your purchase of the AWE Exhaust system for the C8 Corvette Z06.

Exquisite build quality and craftsmanship, coupled with industry leading performance, distinguish this exhaust system from all others.

*For up to the minute fitment information, be sure to visit the AWE website. As always, AWE Performance Specialists are standing by for any questions, [right here](#).

PARTS LIST (SWITCHPATH) - PAGE 1 OF 2



Inspect ALL parts prior to disassembly of vehicle; If **damaged** OR **MISSING**, please contact the place of purchase immediately.

Part Number	Description	QTY
F53	C8 Corvette Z06 DS Valve section	1
F54	C8 Corvette Z06 PS Valve section	1
F55	C8 Corvette Z06 X-pipe	1
F56	C8 Corvette Z06 DS Muffler	1
F57	C8 Corvette Z06 PS Muffler	1
F58	C8 Corvette Z06 DS Tip outlet	1
F59	C8 Corvette Z06 PS Tip outlet	1

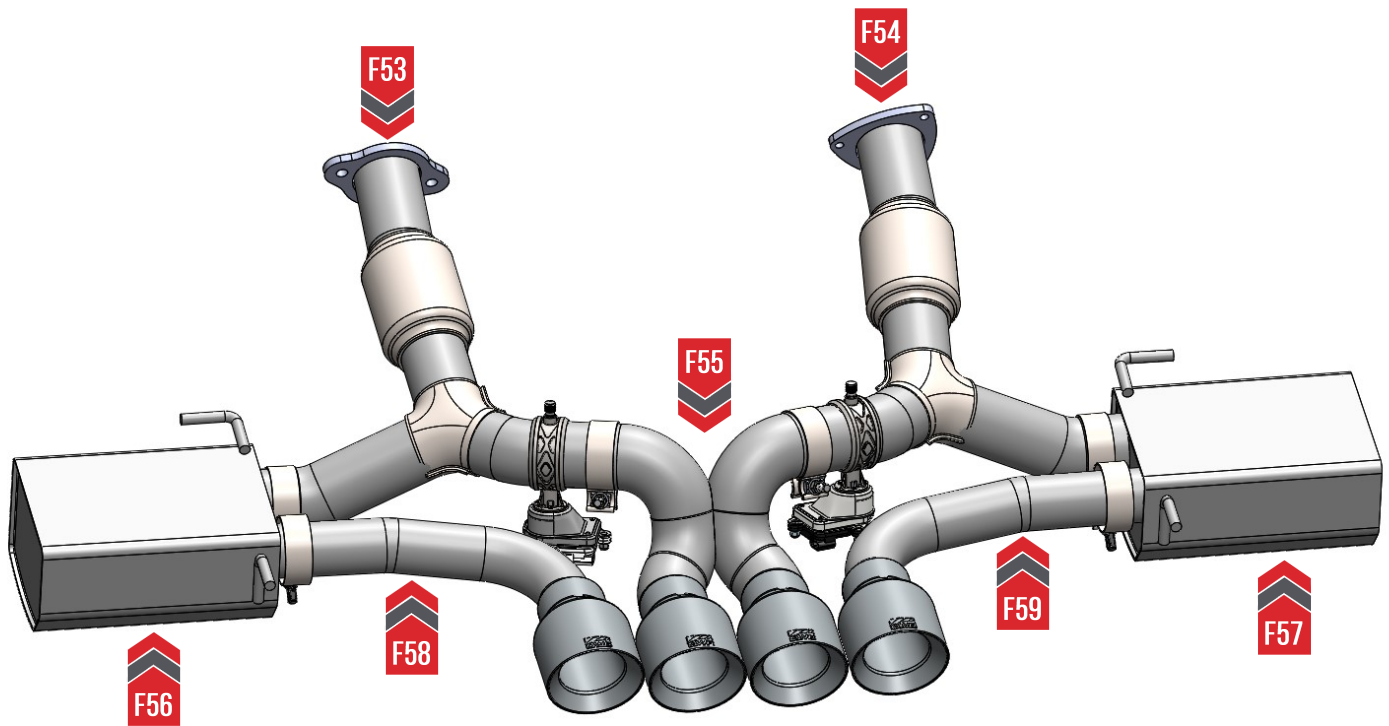

PARTS LIST (SWITCHPATH) - PAGE 2 OF 2



Inspect ALL parts prior to disassembly of vehicle; If **damaged** OR **MISSING**, please contact the place of purchase immediately.

Symbol	Part Number	Description	QTY
A >>	180015	4.50" OD x 3.00" ID, Slash Cut, Diamond Black, AWE Logo, Tips	4
B >>	3910-41010	Hardware Kit for Integrated Clamp Style Exhaust Tips - Quad	2
C >>	180300	AWE 3.0" Band Clamp, Stainless	6
D >>	7130K59	7.5 INCH ZIP TIE (MEDIUM)	2
E >>	3910-11008	HARDWARE KIT FOR C8 CORVETTE	2
F >>	110092	C8_Z06_DS_HeatShield	1
G >>	110093	C8_Z06_PS_HeatShield	1
H >>	1325-11031	Wiring Harness Extension for C8 Z06	2
I >>	MSPX6X20SS	M6 x 20 Stainless Torx Bolt	10
J >>	150014	C8_Zo6_Valve_Bracket	2
K >>	91458A114	Blue Locktite 243 .017 FL OZ	1
L >>	7130K56	14' ZIP TIE (LARGE)	1

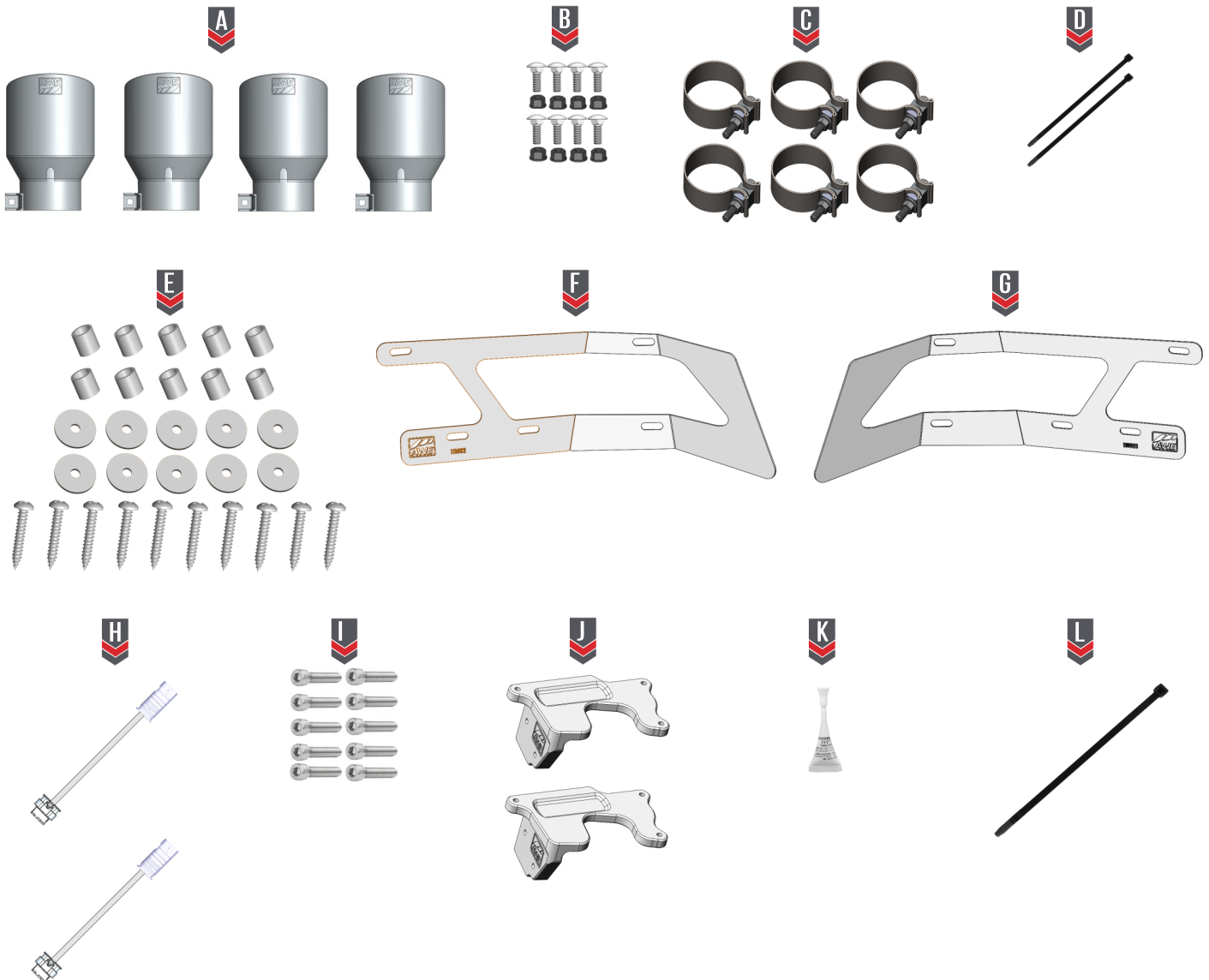



NOTE: Always refer to the manufacturer's service manual for precise torque specifications on all OEM fasteners.



CAUTION: The exhaust may be **VERY HOT** — allow adequate time for the system to cool down before disassembly. Severe burns and injury will occur if skin comes into contact with a hot exhaust system.

STEP 1

Start by removing the trunk liner for access to the exhaust flanges. First remove the 2 latches, shown as (A.) Then remove the trunk liner, shown as (B.)

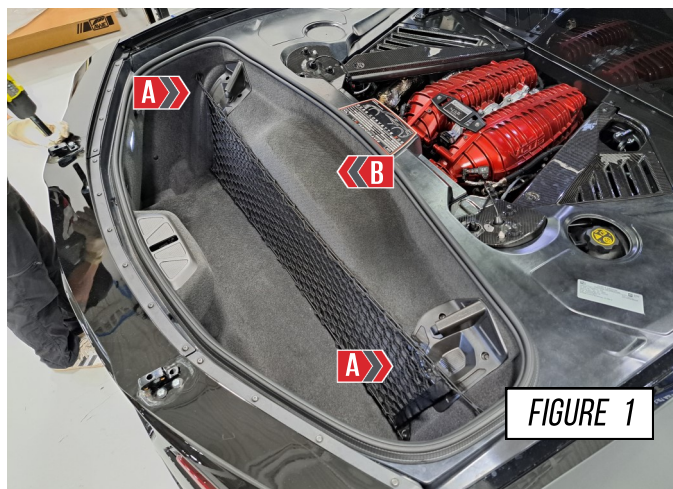

FIGURE 1

STEP 2

With the trunk liner removed, remove the screws holding the maintenance door in place, as shown in **Figure 2**.

Note: Save for reinstalling

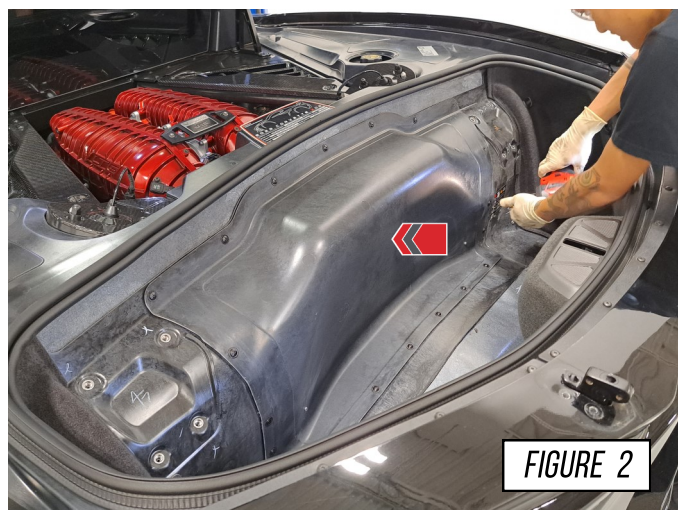

FIGURE 2

STEP 3

Spray both the driver and passenger side flange with penetrating oil, to aid in removal. Let the penetrating oil soak while removing the bumper.



Exhaust must be cool or oil will burn.

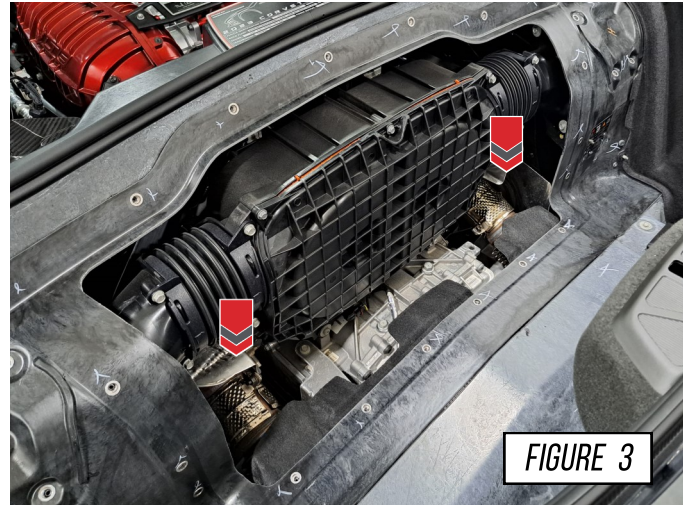

FIGURE 3

STEP 4

On both the driver and passenger side of the vehicle, remove the OE plastic covers, shown in **Figure 4**.

The covers are attached with plastic tabs, to remove carefully but firmly pull away from the vehicle.



FIGURE 4

STEP 5

With the OE covers removed from both sides, under the covers you will find 1 torx screw per side holding the wheel liner in places, remove these screws, as shown in **Figure 5**.

Note: Save for reinstalling

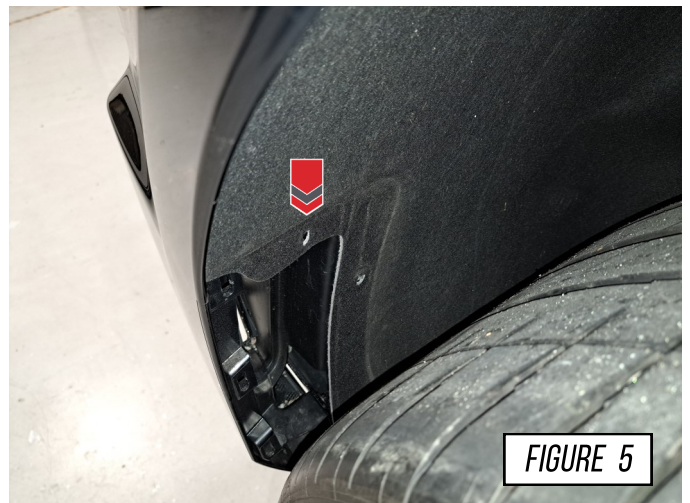

FIGURE 5

STEP 6

Pull back the wheel liner and remove the 2 torx screw (A) and the 1 nut (B) per each side, shown in **Figure 6**.

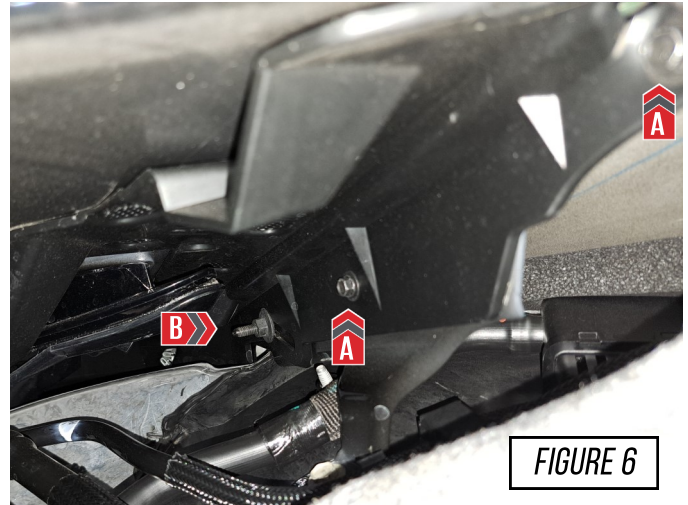

FIGURE 6

STEP 7

Remove the 2 OE plastic covers on the bottom side of the bumper, held in place with a combination of torx screws, hex screws and plastic reusable rivets, shown removed in **Figure 7**.

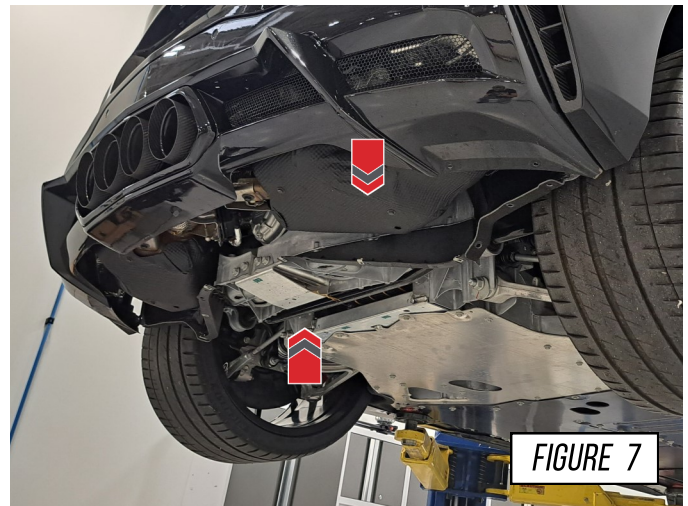

FIGURE 7

STEP 8

Remove the torx screws along the top of the bumper under the trunk lid, shown in **Figure 8**.



FIGURE 8

STEP 9

Remove the bumper by carefully pulling it straight off, with enough space reach down and unplug the 3 OE plug connectors, shown in **Figure 9**, then completely remove the bumper.

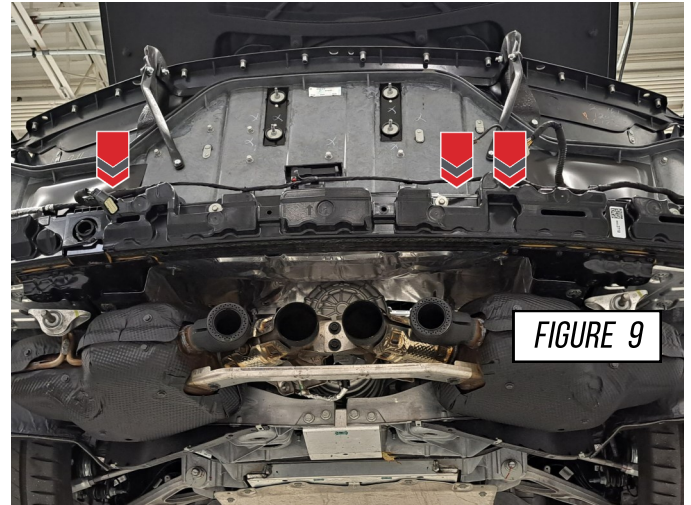

STEP 10

Remove the 2 bolts per side holding the two rear muffler hangers in place, as shown in **Figure 10**.

Note: Allow exhaust to fully drop down, for access to the down pipe bolts.

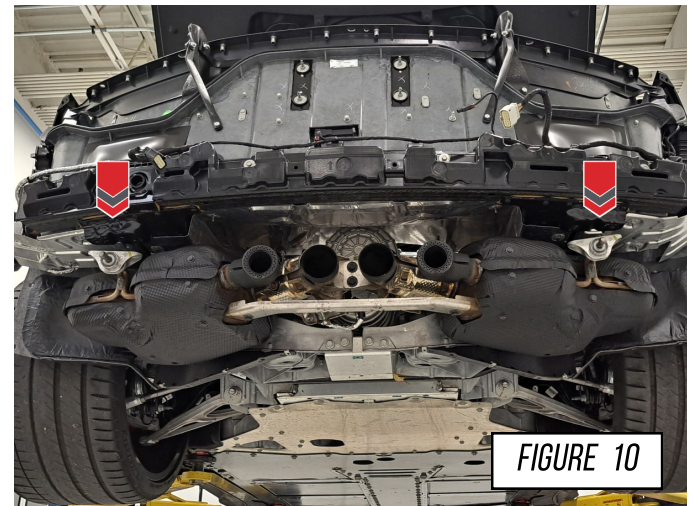

STEP 11

Unplug the 2 OE valves and detach the plastic clips from the exhaust studs keeping the harness in place, as shown in **Figure 11.1** and **Figure 11.2**.

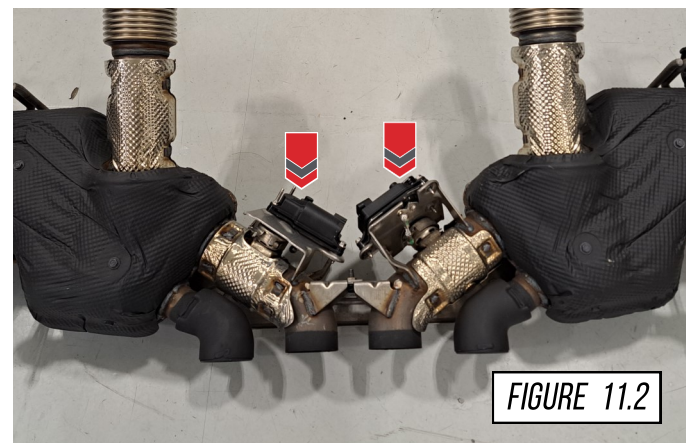
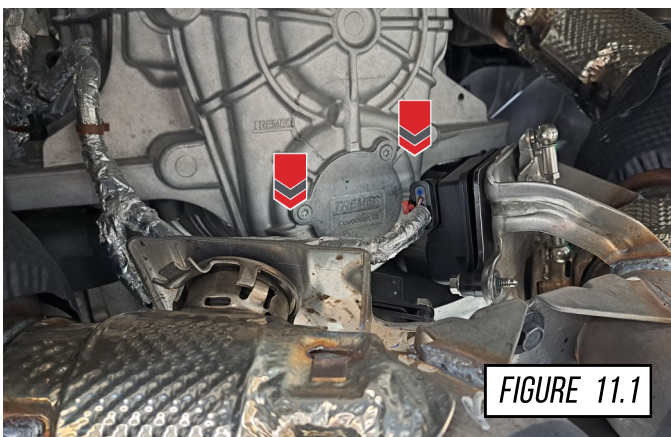

STEP 12

Remove the 2 bolt driver side flange and 3 bolt passenger side downpipe flange, from in the truck compartment, shown in **Figure 12.1** and using a long extension, shown in **Figure 12.2**.

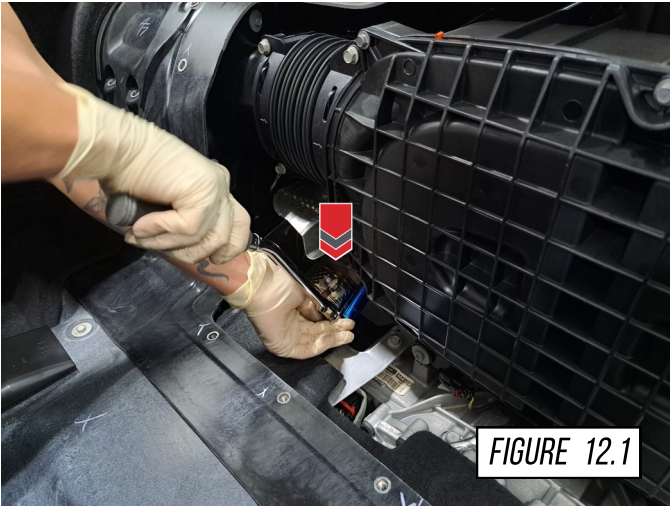

STEP 13

Now remove the OE exhaust by removing the 2 middle hangers, shown in **Figure 13.1**, allowing the exhaust to be removed as 1 piece, shown in **Figure 13.2**.

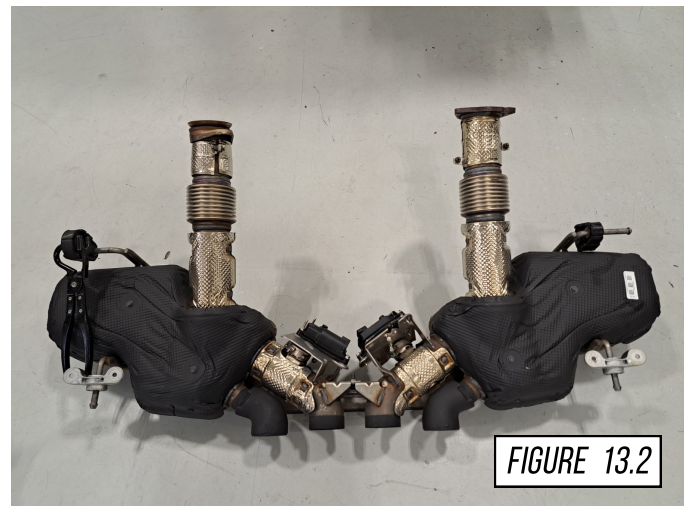
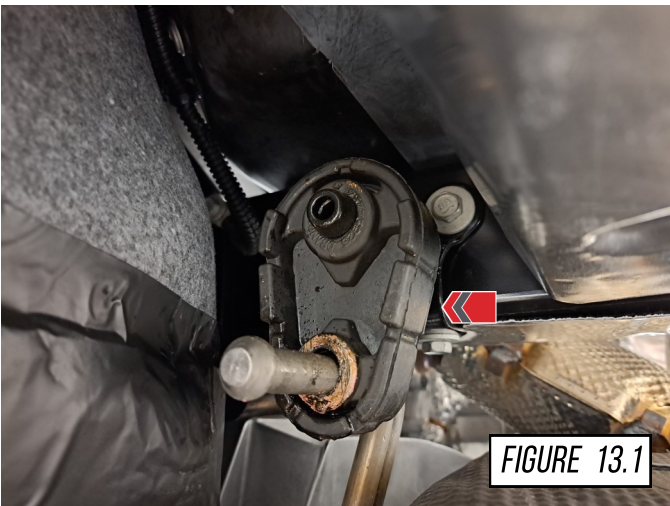

STEP 14

Remove the OE valve motor and arm from the OE exhaust. First remove the clip securing the ball joint (A), then pull ball joint off of OE valve, next remove the 3 bolts (B) holding the motor to the exhaust, as shown in **Figure 14.1**.

Note: Do NOT spin the valve motor.

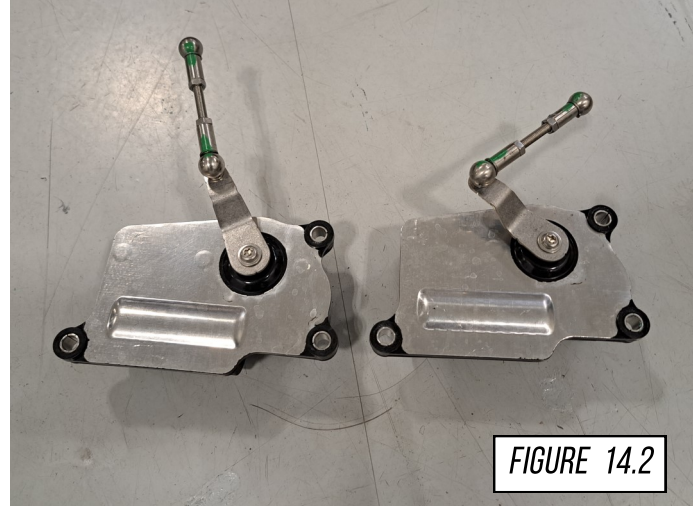
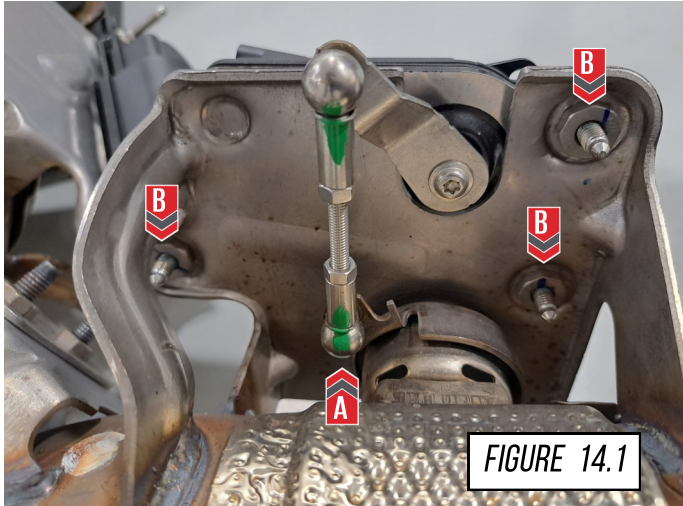

STEP 15

Gather the 2 OE valve motors, the supplied thread locker, 10 bolts, and two 150014 brackets, as shown in **Figure 15.1**.

Using a small amount of thread locker on each bolt, attached the bracket to the OE motor, as shown in **Figure 15.2**.



Do NOT move arm (A) from original position.

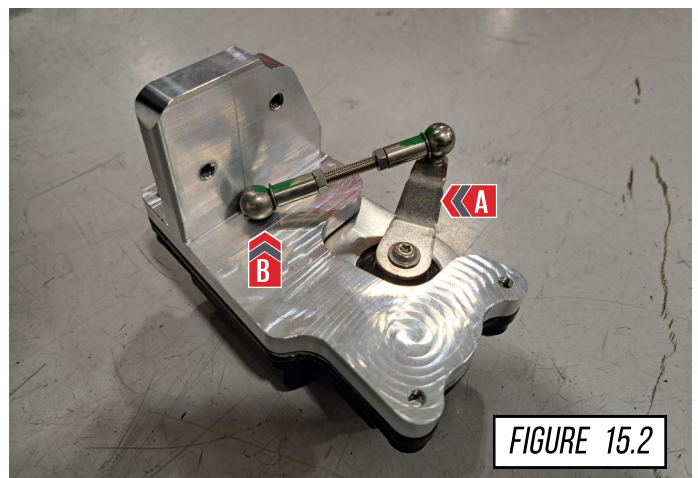
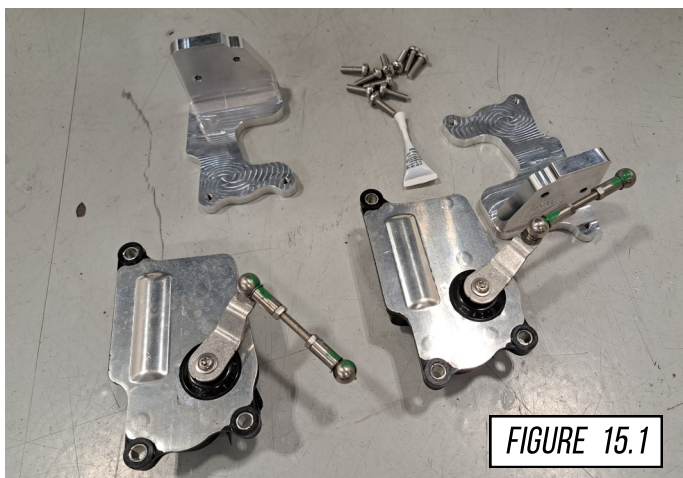

STEP 16

Gather the 2 AWE valve sections (**F53**) and (**F54**), and the two built valve motors and brackets, shown in **Figure 16.1**.

Using a small amount of thread locker and 2 bolts to secure the bracket to the valve on the welded tube, as shown at arrow in **Figure 16.2**.

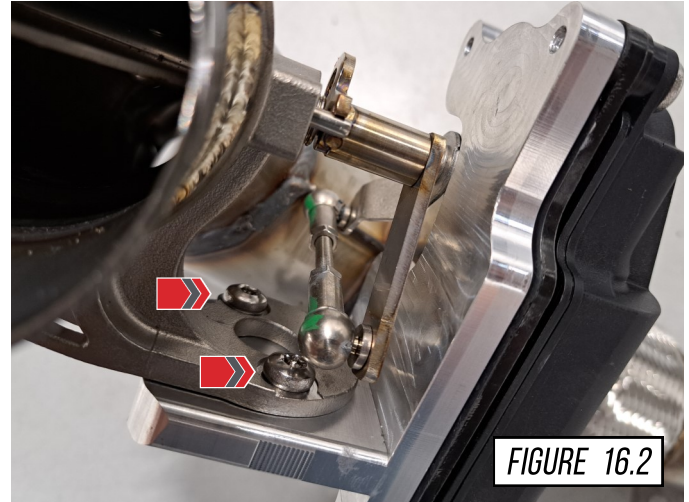
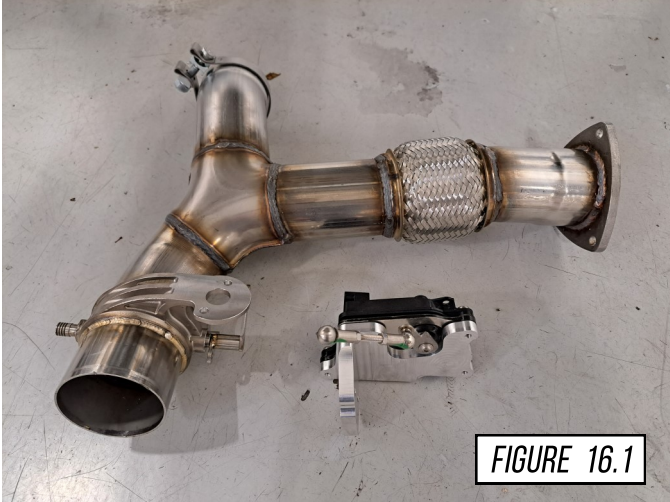

STEP 17

Secure the ball joint, as shown at (**B**) in **Figure 17**.

Note: Ensure to reinstall the OE locking pin.

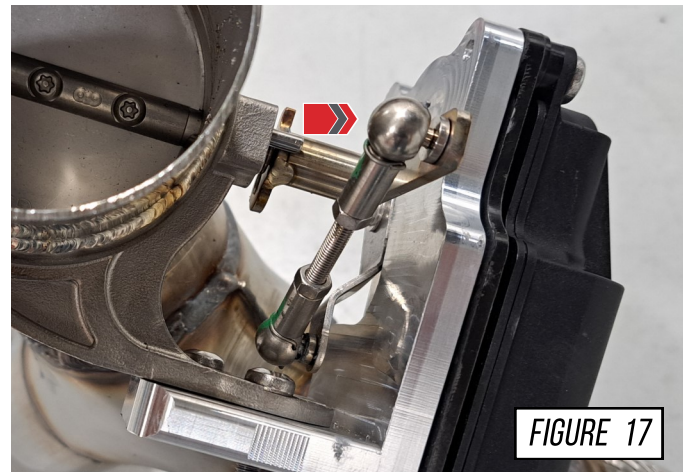

STEP 18

Install your driver side AWE valve section (F56) using the 2 OE nuts, as shown in **Figure 18**.



Do not tighten down flange at this time.

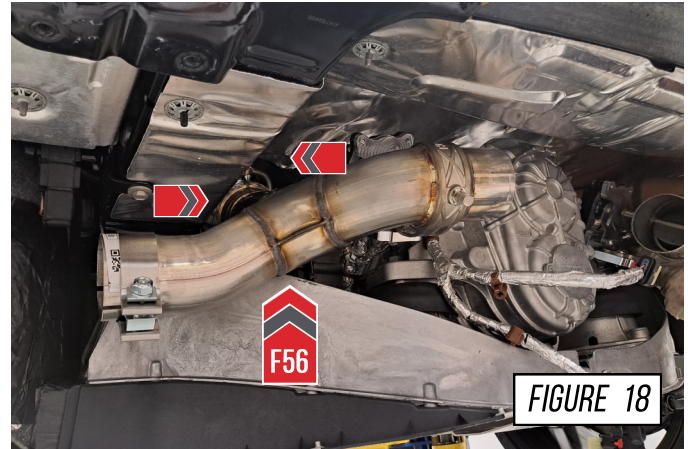

FIGURE 18

STEP 19

Install your passenger side AWE valve section (F57) using the 3 OE nuts, shown in **Figure 19**.

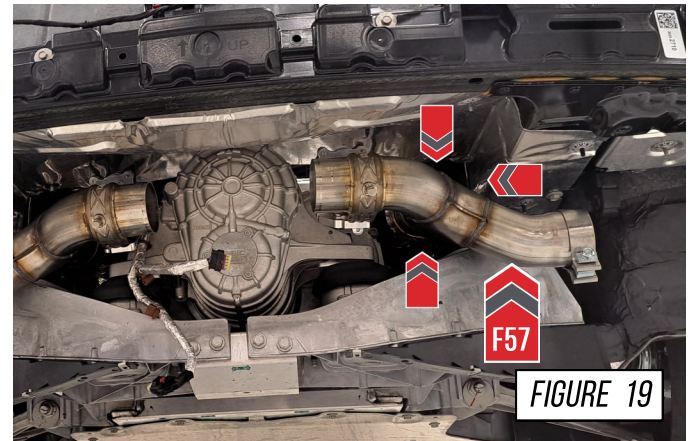

FIGURE 19

STEP 20

It is crucial to install each section and exhaust band clamps correctly to prevent loose joints, exhaust leaks and rattles.

Arrow A shows the expanded pipe and the preinstalled exhaust clamp being brought up to the corresponding pipe.

Arrow B shows the overlapping pipe installed correctly over the corresponding pipe.

Arrow C shows the exhaust band clamp being brought to the edge of the expanded pipe.



NOTES:

- **Do not** fully torque any exhaust clamp until the entire exhaust has been installed and adjusted.
- Torque specification is a **minimum** of 60 ft/lbs

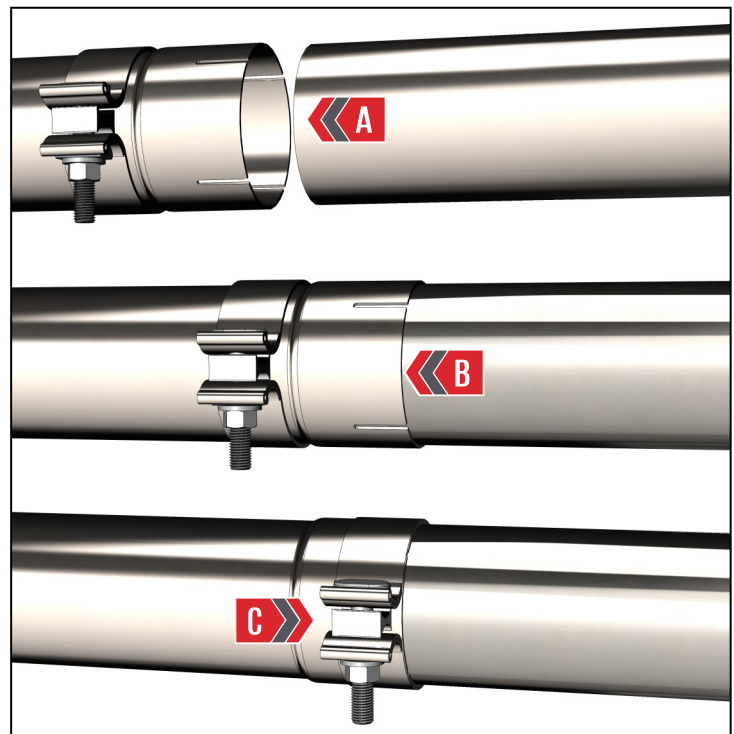

STEP 21

Install your AWE X pipe section (**F55**) with 2 supplied clamps and the slip fits over both AWE valve sections, as shown in **Figure 21**.

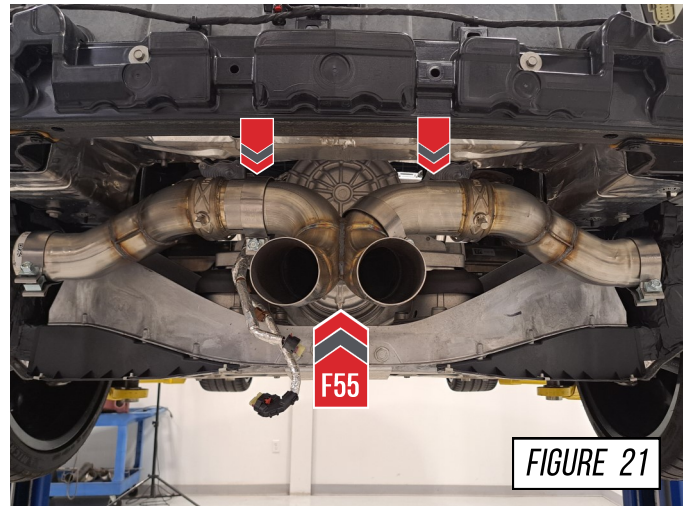

STEP 22

Next gather the two provided wiring harness extensions (**1325-11031**). Plug these both into the OE valve harness, as shown in **Figure 22.1**. Then use the two provided 7" cable ties to band together the OE harness as shown in **Figure 22.2**.

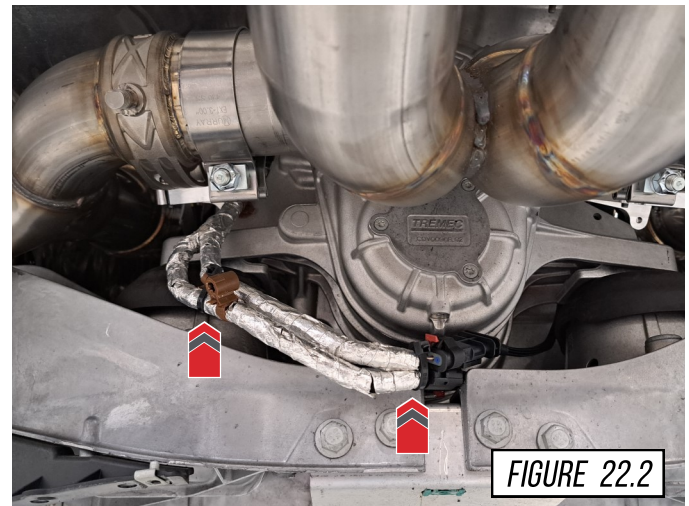
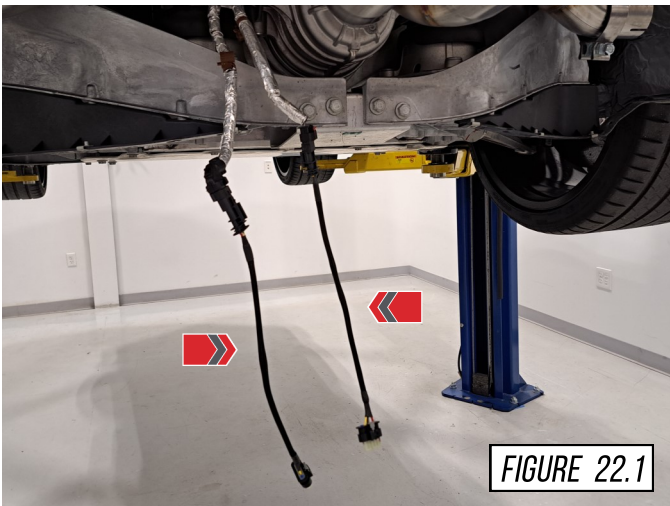

STEP 23

Now guide the wiring harness between the transmission and mounts (**A**), then up to the valve motors (**B**), plug in both valves, as shown in **Figure 23**.

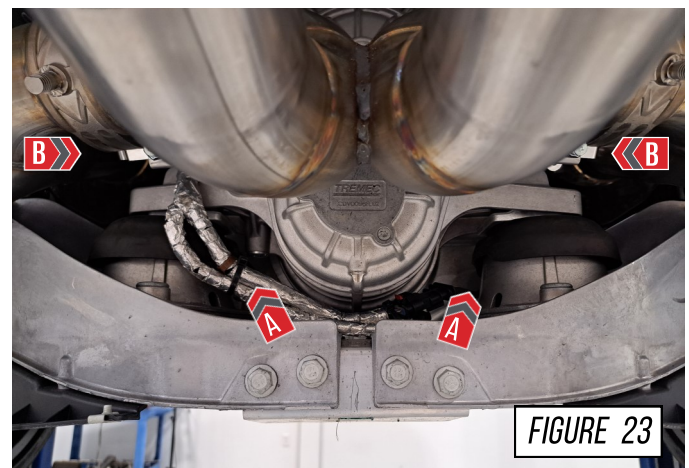

STEP 24

Gather the one long 14" cable tie, fold the cable tie in half and go over and around the wiring harness (A), there is a small hole in the chassis, slide both ends of the cable tie through that hole (B), secure the cable tie around the bar on the chassis (C), as shown in **Figure 24.1** and **24.2**.

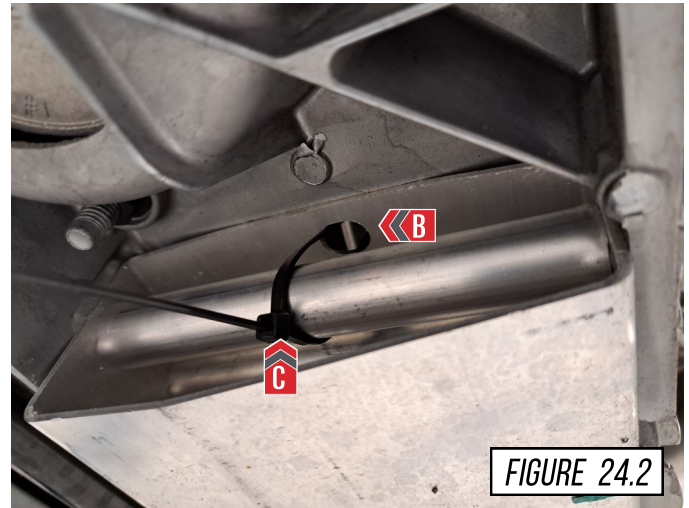
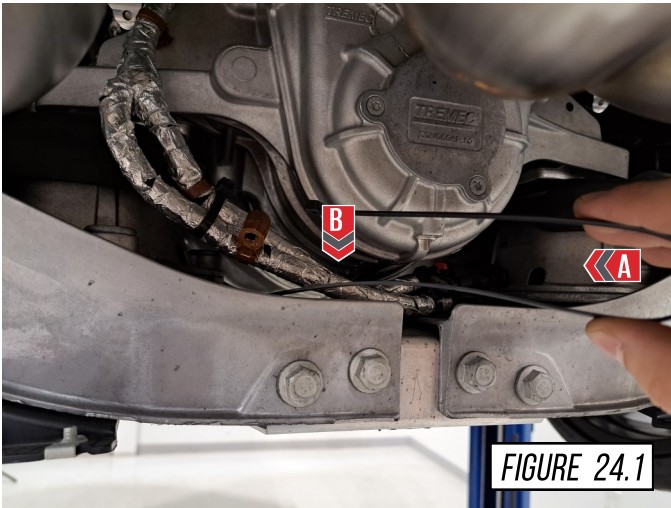

STEP 25

Gather your driver (F56) and passenger (F57) muffler sections, install them using the OE rubber mounts and the supplied exhaust clamps, as shown in **Figure 25**.

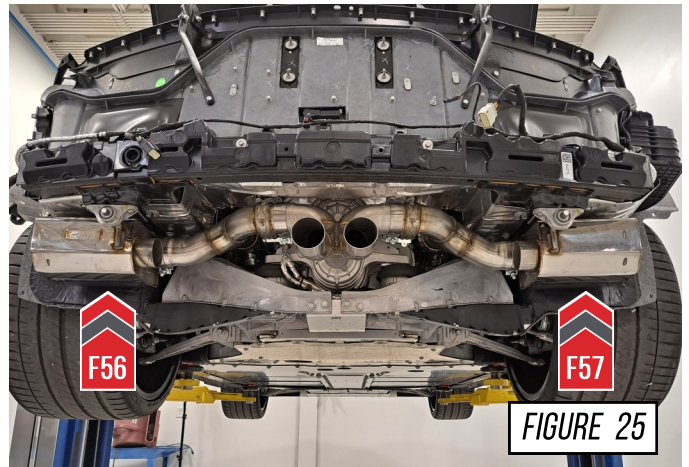

STEP 26

Gather your driver (F58) and passenger (F59) tip outlets, install them using the two supplied 3" exhaust clamps, as shown in **Figure 26**.

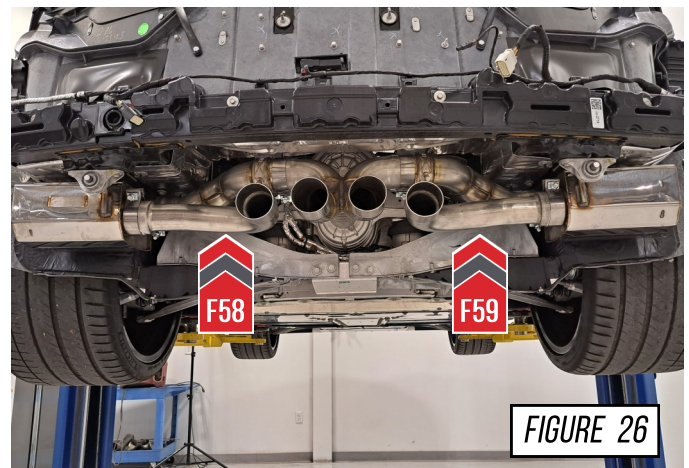

STEP 27

Now go to the bumper and remove the OE tip section, as this will not be needed with your AWE exhaust. Do so by removing the OE hardware, as shown in **Figure 27.1**. Then pull the tip assembly off the bumper, as shown in **Figure 27.2**

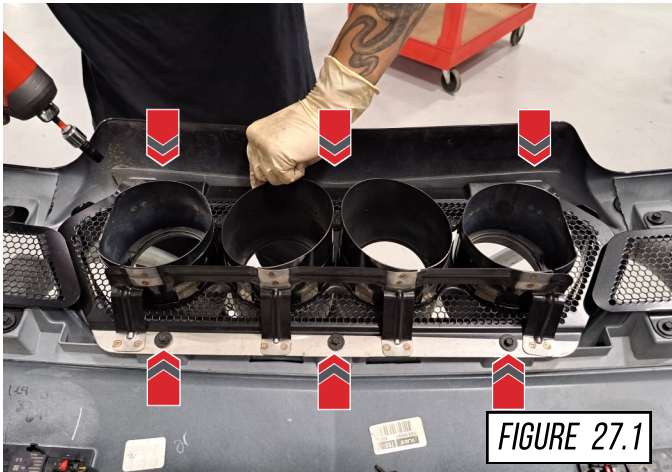

STEP 28

Gather the two heat shields 110092/ 110093 (A) and the hardware packs 3910-41010 (B). Remove the OE bolts in the bumper (C), as shown in **Figure 28.1**. Using the hardware pack install the heat shield with the spacers on the back side, for ease of install follow the order, shown in **Figure 28.2**

Note: Repeat this step for the other side.

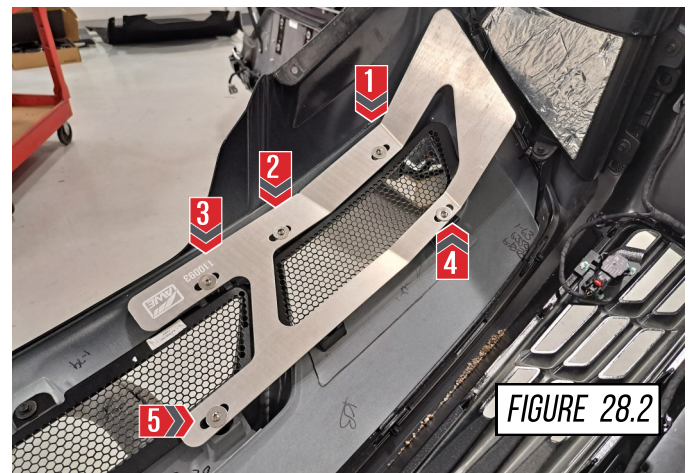
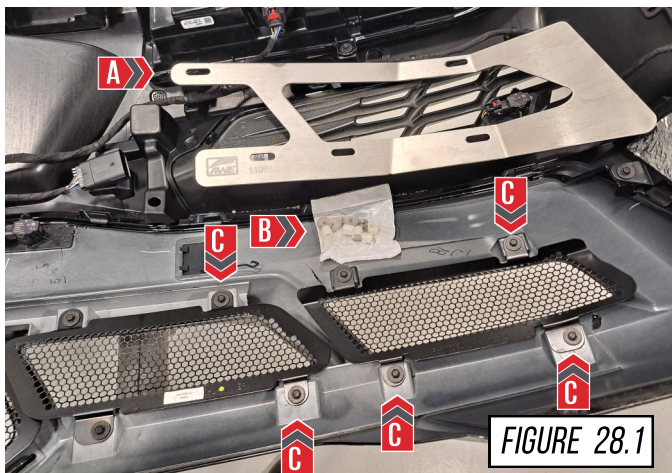

STEP 29

Reinstall the rear bumper, ensure the 3 OE plug connectors are connected and re attached to the bumper as before removed, as shown in **Figure 29**.



Tips will not be install yet.

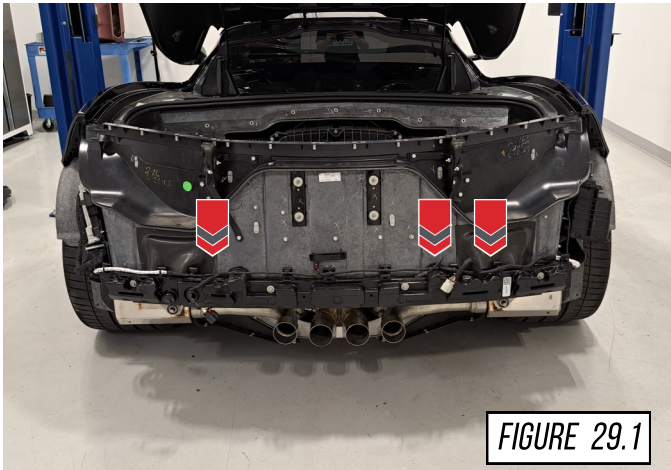

STEP 30

Reinstall the torx screws along the top of the bumper under the trunk lid removed earlier, as shown in **Figure 30**.



STEP 31

Pull back the wheel liner and reinstall the 2 torx screw (A) and the 1 nut (B) per side, as shown in **Figure 31**.

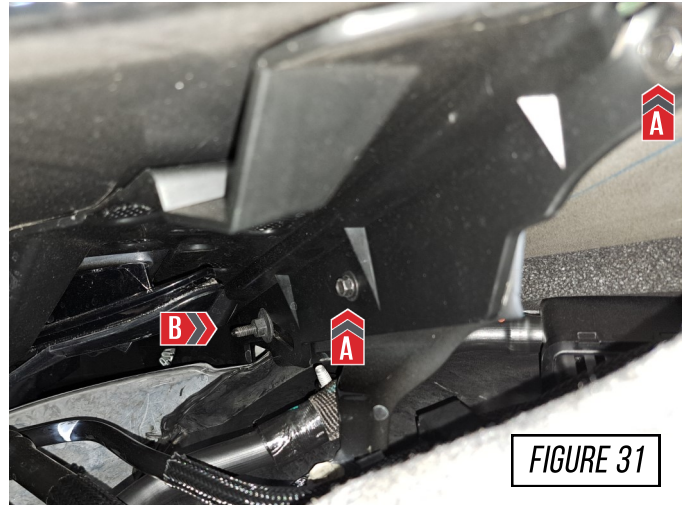

FIGURE 31

STEP 32

Reinstall the 1 torx screws per side holding the wheel liner in places, as shown in **Figure 32**.



FIGURE 32

STEP 33

Reinstall the driver and passenger OE plastic covers. The covers are only attached by plastic clips, firmly push the part onto the vehicle, as shown in **Figure 33**.



FIGURE 33

STEP 34

To install the exhaust tips with integrated clamps, first, attach the exhaust tip in the proper orientation onto the exhaust outlet tube.

Insert one of the carriage bolts from the hardware kit (**3910-41010**) through the tab on the exhaust tip and thread on one of the corresponding nuts.

Using anti-seize on the bolt threads will help installation and prevent breakage of hardware.

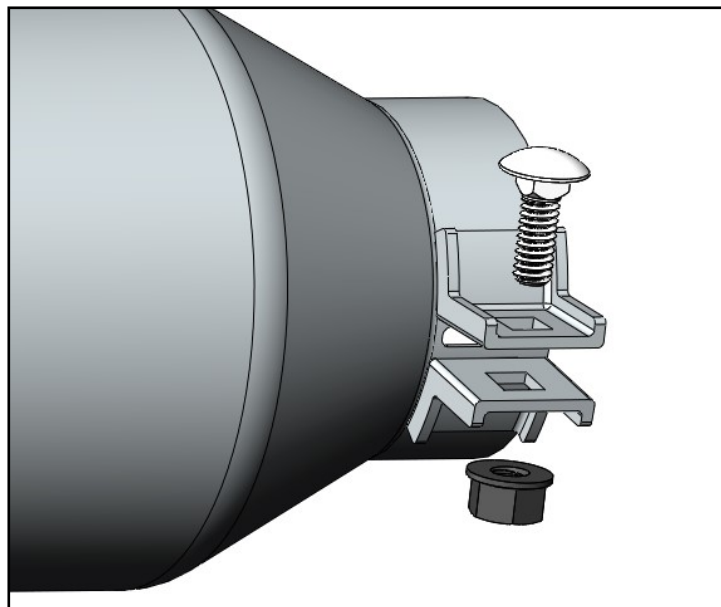

STEP 35

Now install the four tips (180015) onto your exhaust, as shown in **Figure 35**.

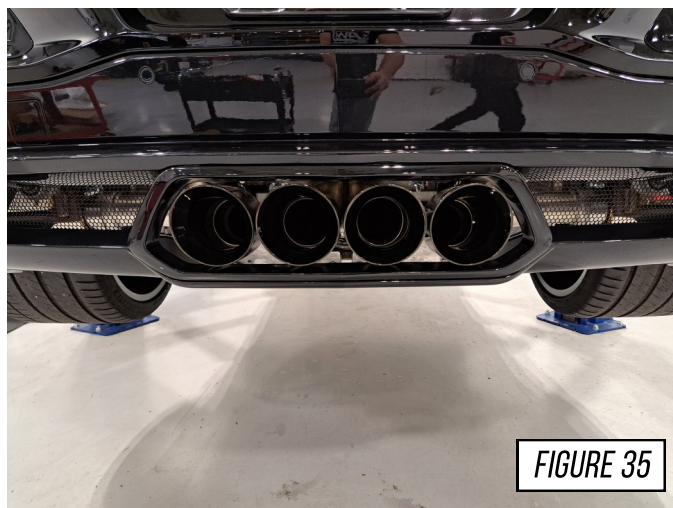

STEP 36

With your tips installed work from the flanges to the tips, tightening all the bolts and clamps, while ensuring proper tip alignment, as shown in **Figure 36**.



STEP 37

With the flanges tightened, reinstall the OE screws holding the maintenance door in place, as shown in **Figure 37**.

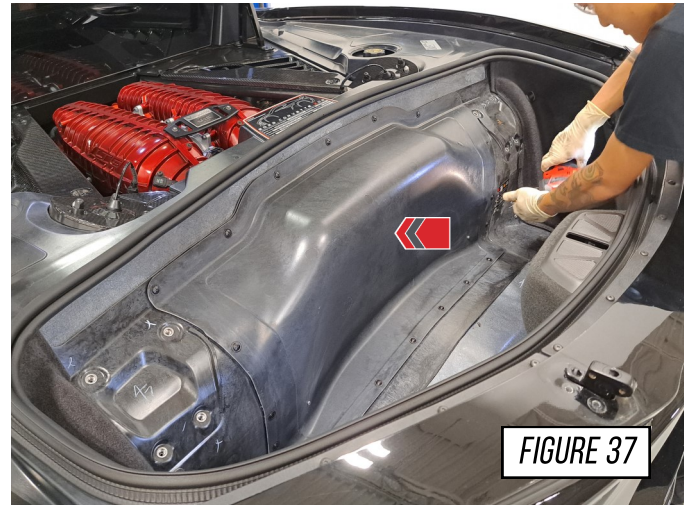

STEP 38

Reinstall the trunk liner by first installing the trunk liner (A), then install the two latches (B), as shown in **Figure 38**.

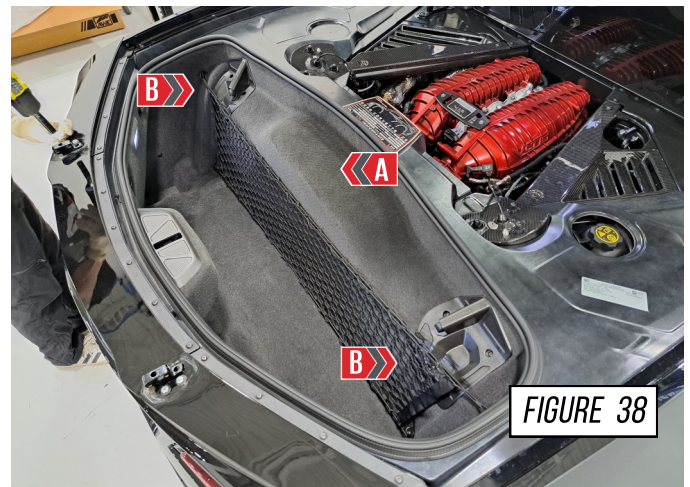

STEP 39

Reinstall the 2 OE plastic covers on the bottom side of the bumper, attached with a combination of torx screws, hex screws and plastic reusable rivets, as shown in **Figure 39**.

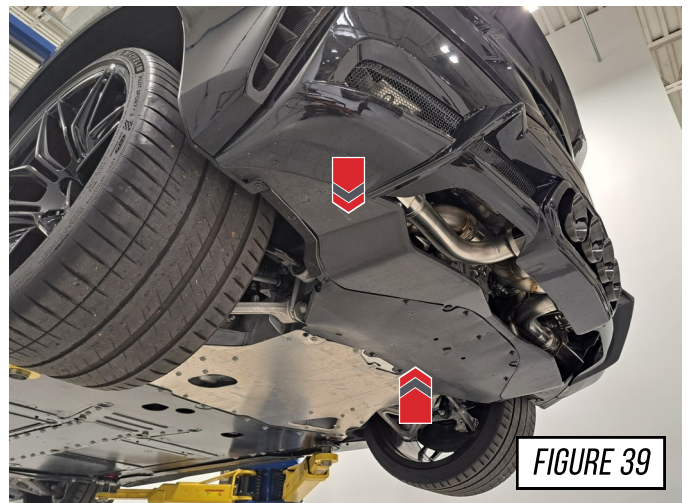

STEP 40

With the complete AWE exhaust system installed, all clamps tightened and the tips aligned. It is now recommended to drive the car to allow the exhaust to heat cycle.

 At this point the exhaust will be **very hot**, allow to cool before work continues.

With the car cooled down, check the tips for correct alignment, if adjustment is required a 2nd hardware (**3910-11008**) pack is provided.

 Don't forget to look below for any troubleshooting needs!



ENJOY!



TROUBLESHOOTING

Issue	Solution
Exhaust is not fitting correctly	Most fitment issues are due to improperly adjusted exhaust. This includes tip fitments and rattling due to chassis contact. Check out our fitment guide for more installation tips.
Incorrect or missing parts	Double check the parts list for your system and compare them with what you received. Fill out our contact form, found below and let us know what parts you need.

CARE

Once installed properly, your AWE exhaust will provide years of trouble-free performance. The exhaust volume and sound will settle with usage; 800-1000 miles is required to break-in new exhaust systems.

Also, please note that the rear **180Technology®** resonator has a small drain hole to allow condensation to escape. Water drops from this area are normal.

Periodic cleaning of exhaust tips is necessary to maintain proper finish, especially in areas prone to road salt and caustic deicing solutions. Use a mild soap and water solution or car wax to clean the finish. Avoid using abrasive polishes, as they can scratch the finish.

Any questions or comments,
please do not hesitate to contact us:

AWE
[CONTACT FORM](#)

WARRANTY

Up-to-date warranty information is found [HERE](#).