



# Day-Light Lamp (Model DL93011)

## User Guide

### Read all instructions before using the Day-Light

#### Safety Precautions

1. As with any electrical device, do not use the Day-Light in or near water.
2. **Do not overuse the Day-Light.** Recommended usage is 20-30 minutes each morning. Overuse may cause irritability, excessive energy, or difficulty falling asleep at bedtime.
3. It is not necessary to stare into the light. Feel free to read, work, eat or talk on the phone during your light therapy session. See page 6 for correct positioning.
5. During the first few uses, your Day-Light may give off an odor; this is harmless. This will not affect the use of your Day-Light and will quickly disappear.
6. Do not leave your Day-Light on for more than 60 minutes in Therapy mode. Always use in a well ventilated area away from other heat sources and ensure that the air vents are not blocked when the product is in use.



day  light

### SAVE THESE INSTRUCTIONS

**The Day-Light is intended for household use only.**

#### Disclaimer

**The Day-Light is an innovative light supply system and is not a listed medical device in the USA.**



Carex Health Brands

## Thank you for purchasing the Day-Light!

This bright light system was designed following the highest quality and safety standards. For details on correct assembly and proper use of your Day-Light, please read this manual in its entirety. Additional product information may found at [www.carex.com](http://www.carex.com).

### Day-Light Benefits

The Day-Light brings the light of a springtime morning into your home or office. Use your Day-Light to help relieve the Winter Blues. Daily use during the fall, winter and early spring to help keep your mood and energy level up, while pleasantly brightening your day.

<b>DL93011 SPECIFICATIONS</b>	
<b>Safety:</b>	UL & C-UL Listed
<b>Electrical:</b>	120 VAC, 60Hz, 1.5A
<b>Enclosure Size:</b>	115.75" x 13" x 3.1" / 40 cm x 33 cm x 8 cm
<b>Product Height:</b>	Max - 28.75" / 73 cm
	Min - 25" / 63.5 cm
<b>Product Weight:</b>	9.35 lbs / 4.24 kg
<b>Ballasts:</b>	Electronic, instant start, no flicker
<b>Lens Material:</b>	High-impact polycarbonate
<b>Diffusing Filter:</b>	99.3% UV filtered, glare-free tint
<b>Light Settings:</b>	1) 3 light - 10,000 LUX at 12"
	2) 2 light - 7,000 LUX at 12"
<b>Light Tubes:</b>	3 x 36 watt compact fluorescent
	4000 Kelvin color temperature
	CRI = 85
	<b>Re-order - Day-Light 973</b>
<b>Warranty:</b>	Five-year limited

#### **Important Information**

Always consult your physician before starting any bright light therapy regimen.

Your Day-Light includes the following components:

- Lamp Head
- Adjustable Height Arm Assembly
- Weighted Lamp Base
- Component power cord
- #2 Philips Screwdriver
- 1 Philips Screw
- User Guide
- Warranty Registration Card

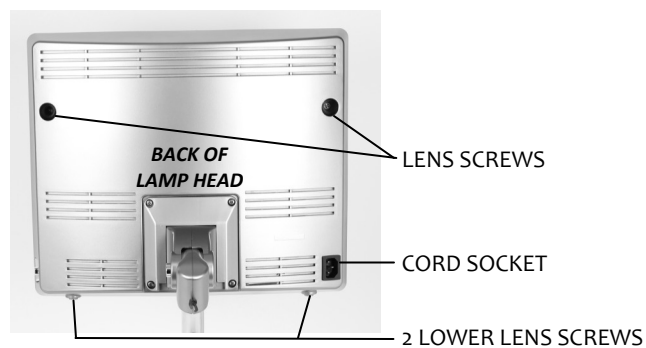
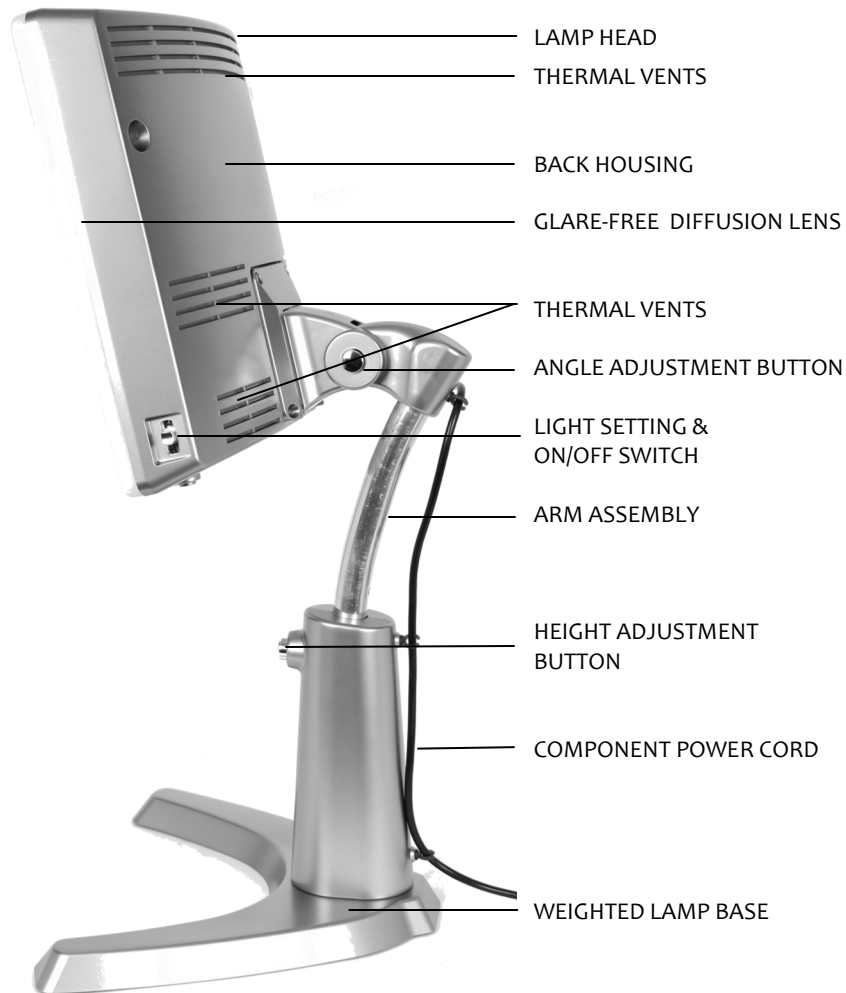

## Before Using Your Day-Light

Task light, reading lamp, or simply for glare-free ambient light, your Day-Light can be used for much more than light therapy.

1. Check contents to ensure all parts are enclosed and in good condition.
2. Review this guide in its entirety.
3. Assemble the lamp and test the light tubes.

Complete your Warranty Registration online at [www.carex.com](http://www.carex.com) or send in your Warranty Card to ensure you are registered. **Contact your dealer if any product parts are missing or damaged.**

### Assembling the Day-Light

1. Attach the Weighted Lamp Base (1a - 1e) to the Adjustable Height Arm using the screw and screwdriver.
2. Lay the Lamp Head with the lens down on a solid non-skid surface that will not damage the lens.
3. Slide the assembled Arm and Base (3a) into the Lamp Head.

**WARNING: The locking tab (3b) must be fully engaged as shown to prevent the Arm and Base from detaching from the Lamp Head and causing possible injury.**

4. Fully insert the component plug (4a) and secure the cord using the 3 clips on the back of the Arm. Plug into a standard 120 VAC grounded outlet.

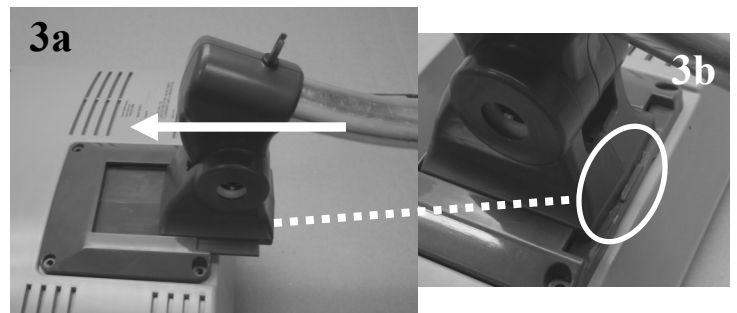
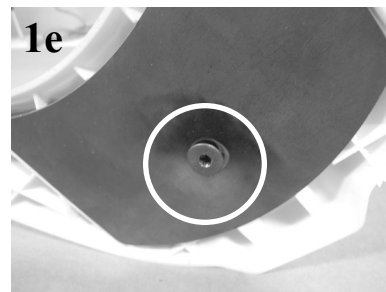
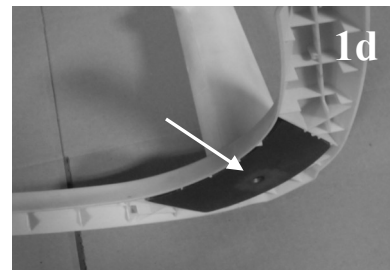
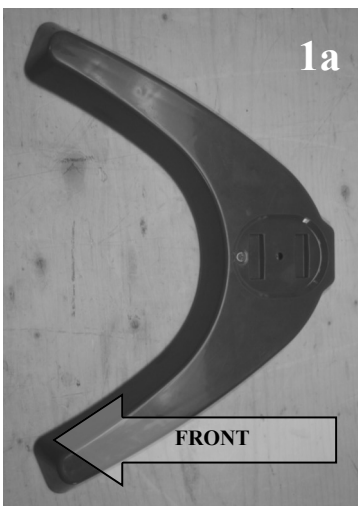

## Test the Light Tubes

Your Day-Light uses three 36 watt compact fluorescent light tubes and has a two and three light setting.

The center switch position is OFF. For therapy, slide the switch UP. The lamp should illuminate with no gaps (3 bulbs on). Slide the switch DOWN for the task setting. The lamp should illuminate, but at a lower intensity (2 bulbs on).

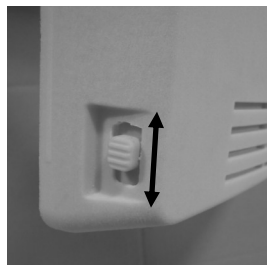

If any tubes do not light up, one or more may be loose or damaged. You will need to remove and reinstall the nonfunctioning tubes to assess the cause of the issue.

## Removing Light Tubes

1. Unplug the Day-Light.
2. Remove the 2 screws on the bottom of the lens first (H) and 2 screws on the back of the light head (I) with the Philips screwdriver.
3. Gently remove the lens being careful not to damage the 2 lower prongs - see image "O".
4. If the light tube is loose remove shipping elastics around the metal clips and discard (J).
5. Remove and discard the rubber shipping insert at the socket base of the light tube (K).
6. To remove the tube, depress the white clip in the middle of the light housing unit (L). With your other hand, grasp the tube near the plastic base and gently wiggle it to raise it above the white clip.
7. Twist the light tube until both sides of the base comes out of the socket.
8. Disengage the light tube from the retainer clip (M).

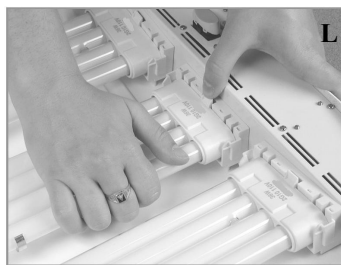
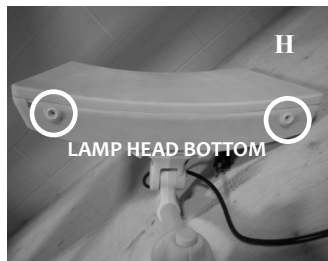

## To Install a Light Tube

1. To re-install the light tube, hold the tube horizontally and slide the top end into the retainer clip.
2. Then gently slide the tube prongs into the socket. When it is fully in place you will hear a 'click' (N).
3. Once the light tubes are installed correctly, plug the Day-Light in and check that the tubes illuminate in each switch position. If working, unplug and continue to the next step. (If not, try again before determining that there is another problem with the light.)
4. Replace the polycarbonate lens by sliding the two prongs on the bottom of the lens into the back housing case (O).
5. Reinstall the two back screws and then reinstall the two bottom screws. Do not over tighten as this could result in stripping the screws and sockets.

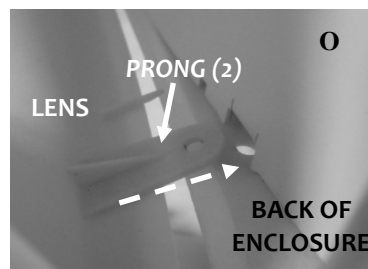

*Light tubes are rated for 8,000 hours of use, but we recommend replacing the tubes after two (2) years of daily, seasonal usage.*

*All fluorescent light tubes deteriorate over time and LUX levels gradually decline. Regular replacement will ensure a 10,000 LUX intensity for your light therapy sessions.*

## **Adjusting the Light Mode**

### **High Intensity Setting - Therapy Mode**

Slide the switch “UP” and the Day-Light emits 10,000 LUX of light at 12” -14” from the lamp - the maximum light level recommended by experts. Do not use your Day-Light for more than 60 minutes per session in Therapy mode.

### **Low Intensity Setting – Task/Ambient Mode**

Slide the switch “DOWN” and only 2 bulbs light, emitting 7,000 LUX at 12” - 14” from the lamp. We recommend moving the Day-Light further away or angling it down over your work area for non-light therapy purposes.

**NOTE: After switching the Day-Light on, it takes about three minutes before the light tubes reach full intensity.**

## **Adjusting Light Angle and Height**

For optimum light therapy usage, you will now need to adjust your Day-Light so that:

- Lamp head is angled at about 30° from vertical;
- Eyes face the approximate center of the lamp.

### **Angle of the Light**

To set the angle of the lamp at about 30°, press the silver button (1) at the top of the Arm, while supporting the Lamp Head. Release the button when the desired angle is achieved.

### **Height of the Light**

Press the lower silver button (2), while supporting the Lamp Head. Lift or lower the Lamp Head to the height that works best for you and release the button. Support the Lamp Head as it locks into position.

**NOTE: Face toward the Day-Light with eyes open during therapy - it is not necessary nor recommended to look directly into the light.**

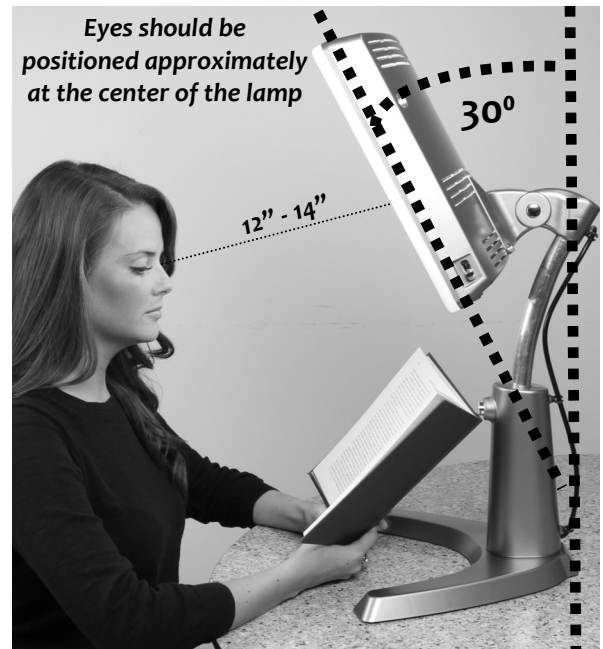
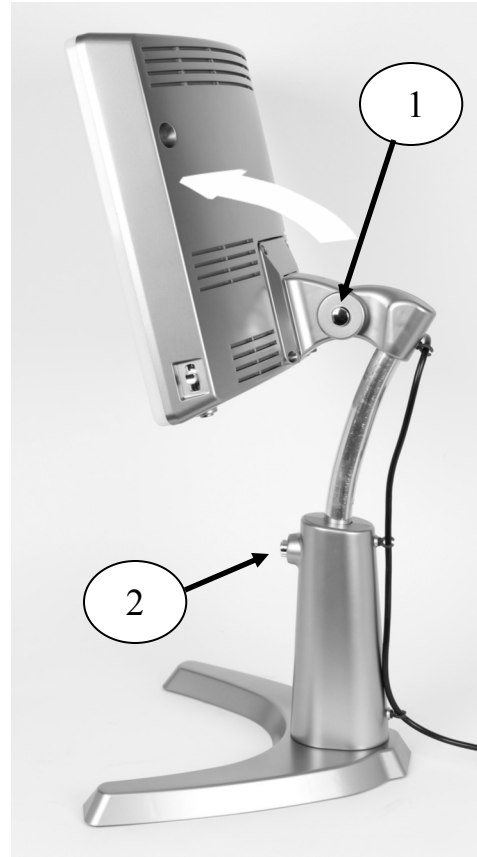

## **The Winter Blues**

### **Timing and Duration of Session**

For best results use your Day-Light soon after waking, preferably before 9 a.m. Begin with a 30 minute session and read, eat breakfast, etc. during therapy.

Benefits usually take a few days to appear. Since each persons response varies, 30 minutes may not produce the desired level of therapeutic response or may cause unwanted side effects. *Studies have shown that up to 85% of those who try bright light therapy have a clinical response.*

Based on your response, tailor the session time, up or down, in five minute increments to find the optimal session length. We recommend that your don't use therapy mode for more than 60 minutes per session.

You may also add a short session (15-20 min.) later in the day, if experiencing a slump in energy. However, using the Day-Light for therapy after 8 p.m. is not recommended as it may delay your onset of sleep.

### **Helpful Resource**

For a personalized profile of your Day-Light needs, we recommend completing the free online user assessments found at [www.cet.org](http://www.cet.org).

### **Adjusting to Light Intensity**

Some users prefer to adjust to the brightness before therapy sessions. Turn the lamp on just before sitting in front of the lamp, so your eyes can adjust to the bright light.

### **Daily Use**

If you miss a session(s) or discontinue use of the Day-Light, your body may return to its usual wintertime doldrums. Benefits should reappear a few days after resuming use.

### **Other Conditions**

Increasing evidence demonstrates that using bright light therapy lamps may also help alleviate jet lag, shift work adjustment, improve sleeping patterns and ease low energy.

### **Waking Up to the Day-Light**

You can also wake up to the Day-Light by using a properly rated lighting timer.

### **Symptoms of Overuse**

There are rarely negative side effects of using light therapy, but it is possible to overuse the Day-Light.

If you experience increased irritability, excessive energy, and/or any discomfort during or after use, decrease the session length or move the light further away from you.



# Day-Light Lamp (Model DL93011)

---

## User Guide

### **Carex Health Brands (USA)**

921 E. Amidon Street  
Sioux Falls, SD, 57104  
1-800-526-8051

### **Carex Health Brands Canada**

10 Morris Drive, Unit 19  
Dartmouth, NS, B3B 1K8  
1-800-387-0896



**Carex Health Brands**

[www.carex.com](http://www.carex.com)

© 2014