

# eXplorist® TRX7

The Ultimate Off-Road GPS Navigator



## User Manual

MAGELLAN and eXplorist are registered trademarks of MTAC International Corp. All other brands are the property of their respective owner.



The Official GPS of  
Jeep Jamboree USA

[MAGELLANGPS.COM](http://MAGELLANGPS.COM)





# Safety.

## IMPORTANT SAFETY WARNINGS

The Magellan eXplorist TRX7 and TRX7 CS are off-road vehicle navigation aids designed to assist you in driving on off-road routes as well as across municipal streets. Please check with your state or local law enforcement for applicable regulations regarding mounting to the windshield. The driver should enter data or program the Magellan device only when the vehicle is stopped. Only a vehicle passenger should enter data or program the device while the vehicle is moving. It is your responsibility to comply with all traffic laws. Every attempt is made to ensure that the database is accurate. However, roadways, points of interest (POIs), and business and service locations may change over time. Keep the device safe from extreme temperature conditions. For example, do not leave it exposed to direct sunlight for an extended period of time. The minimum operating temperature is 14°F (-10°C), and the maximum operating temperature is 140°F (60°C). Mount the device in your vehicle, whether using the windshield mount or other mount or accessories, so that the device does not obstruct the driver's view of the road, interfere with the operation of the vehicle's safety devices, such as airbags, or present a hazard to occupants of the vehicle should the device become dislodged while driving. Comply with all local, state, and federal laws before mounting the device in your vehicle. You assume the risks associated with damage to your vehicle or vehicle occupants as the result of your choices in mounting the device. The battery is rechargeable and should not be removed. Should the battery need to be replaced, please contact Magellan Technical Support at **800-707-9971**, or go to [trxsupport.magellangps.com](http://trxsupport.magellangps.com).

## Charging the Magellan eXplorist TRX7

An AC adapter is included with your TRX7. Use **ONLY** the car charger approved for/supplied with your TRX7. Use of another type of car charger will result in fire or electric shock. For safety reasons, the battery in your TRX7 will stop charging when the ambient temperature is less than 32°F (0°C) or more than 113°F (45°C). The TRX7 requires approximately 4 hours of charging through the vehicle power adapter or AC adapter to obtain a full battery charge. Charge your TRX7 battery initially for at least 2 hours. Estimated usage of the TRX7 on battery power is approximately 4-6 hours. **Note:** Use a 3.5V-5V 2A charger should you need to replace your adapter.

## FCC RF Radiation Exposure Statement

1. This Transmitter must not be co-located or operating in conjunction with any other antenna or transmitter.
2. This equipment complies with FCC RF radiation exposure limits set forth for an uncontrolled environment. This equipment should be installed and operated with a minimum distance of 20 centimeters between the radiator and your body.

Wi-Fi 5G Band 1 is for indoor use only.

## Canada, Industry Canada (IC) Notices

This device complies with Industry Canada licence-exempt RSS standard(s). Operation is subject to the following two conditions: (1) this device may not cause interference, and (2) this device must accept any interference, including interference that may cause undesired operation of the device.

© 2017 MiTAC International Corporation. The Magellan logo and Magellan are registered trademarks of MiTAC International Corporation, and OneTouch is a trademark of MiTAC International Corporation and are used under license by MiTAC Digital Corporation. All rights reserved. All other trademarks and registered trademarks are property of their respective owners. All other products and brand names are trademarks of their respective holders. No part of this user manual may be reproduced or transmitted in any form or by any means, electronic or mechanical, including photocopying and recording, for any purpose other than the purchaser's personal use, without the prior written permission of MiTAC International Corporation. The information provided in this document is correct at the time that it is created. MiTAC International Corporation assumes no responsibility or liability for any errors or inaccuracies that may appear in the contents of this User Manual.

## Magellan Take-Back Program

Magellan's Take-Back Program provides a way for customers to recycle certain Magellan equipment. This program accepts all Magellan GPS models. Visit [magellanGPS.com](http://magellanGPS.com) for more information.

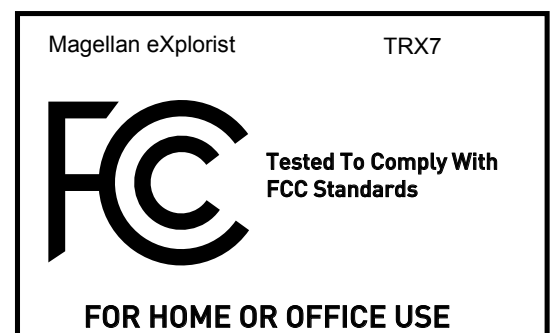

# Table of Contents.

<b>Get To Know TRX7</b> .....	<b>5</b>
TRX7 Hardware .....	6
TRX7 Software .....	7
<b>Get Started</b> .....	<b>8</b>
Turn On Your TRX7 .....	8
Connect to Wi-Fi.....	8
Update Software + Maps .....	8
Create Your TRX Account.....	10
Get a GPS Signal .....	12
Mount the TRX7 in Your Vehicle .....	13
Power On the TRX7.....	14
Turn Off Display and Power Off.....	14
View the Battery Level Indicator .....	14
Adjust Volume .....	15
Adjust Brightness.....	15
Set the Date and Time.....	15
TRX7 Home Screen.....	16
Create Your Vehicle Profile.....	17
Link to Social Media .....	18
<b>Go Riding</b> .....	<b>19</b>
Use Street Navigation.....	19
Tracking .....	20
Change Map Options .....	21
Mark Waypoints .....	22
Social Post .....	24
Backtrack.....	25
Finish (Save) Your Track.....	25
Use the Journal .....	27
Create A New Trip .....	27
Delete A Trip .....	28
<b>Go Exploring</b> .....	<b>29</b>
Search For Map Content .....	29
View and Save Searched Items .....	31
Use Satellite Imagery.....	31
Purchase a DigitalGlobe Subscription.....	32
Save Satellite Imagery from the Map Screen .....	33
Save Satellite Imagery Automatically.....	33

# Table of Contents.

<b>Use TRX Trailhead .....</b>	<b>34</b>
<b>Use TRX Trailhead .....</b>	<b>34</b>
<b>Sign In to TRX Trailhead .....</b>	<b>35</b>
<b>Wish List and Log .....</b>	<b>37</b>
<b>Search for Trails, Tracks, Trips, OHV Attractions, and POIs .....</b>	<b>39</b>
<b>Save To Your Wish List.....</b>	<b>42</b>
<b>Report Issues .....</b>	<b>42</b>
<b>Create a Route.....</b>	<b>43</b>
<b>Connect to Social Media.....</b>	<b>44</b>
<b>Upload GPX Files .....</b>	<b>44</b>
<b>Add a New Trip .....</b>	<b>45</b>
<b>TRX Glossary .....</b>	<b>46</b>
<b>Warranty.....</b>	<b>48</b>
<b>Technical Support .....</b>	<b>50</b>



# Get To Know TRX7.

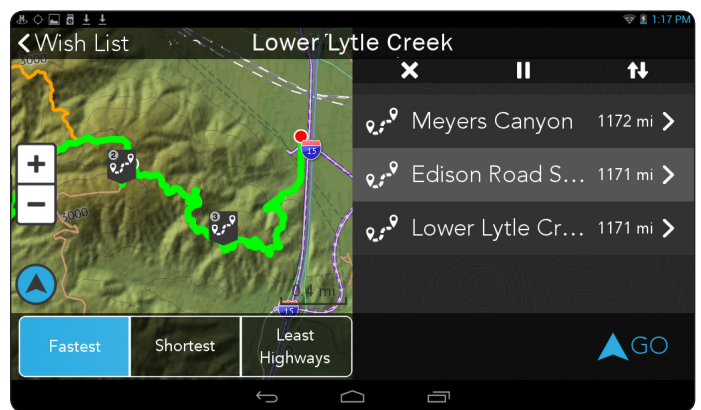
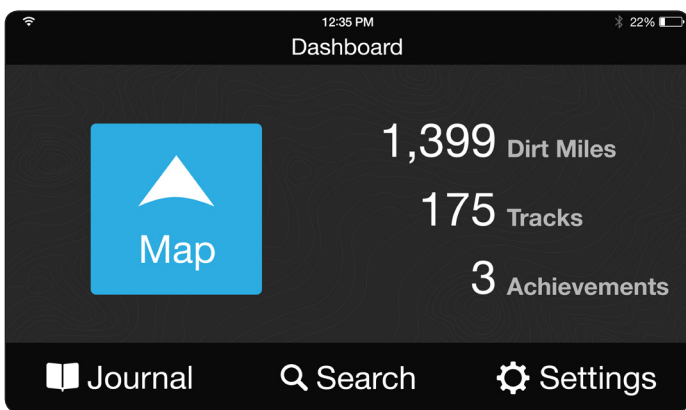

Designed specifically with the off-roader in mind, the Magellan eXplorer TRX7 is a GPS map and navigation system purpose-built for off-road use and street navigation.

Powered by a ruggedly constructed tablet, the TRX7 includes the largest database of off-road Trails in the U.S., with over 100,000 official Trails preloaded into the device.

The TRX7 also gives you access to a growing database of user-generated Tracks, which allows you and thousands of other off-roaders to upload custom off-road adventures, waypoints, detailed terrain info, and up-to-date trail conditions that all members of the TRX community can see.

The TRX7 is also connected to an ecosystem of TRX products, including:

- TRX Trailhead, an online planning and sharing tool at [www.TRXTrailhead.com](http://www.TRXTrailhead.com).
- TRX Support, a site for troubleshooting, technical support, and feedback at [trxsupport.magellangps.com](http://trxsupport.magellangps.com).
- TRX companion mobile apps for **iOS** and **Android**

The Magellan eXplorer TRX7 contains the most detailed and accurate information and data that you can trust to increase the enjoyment and confidence of your off-road driving experiences.

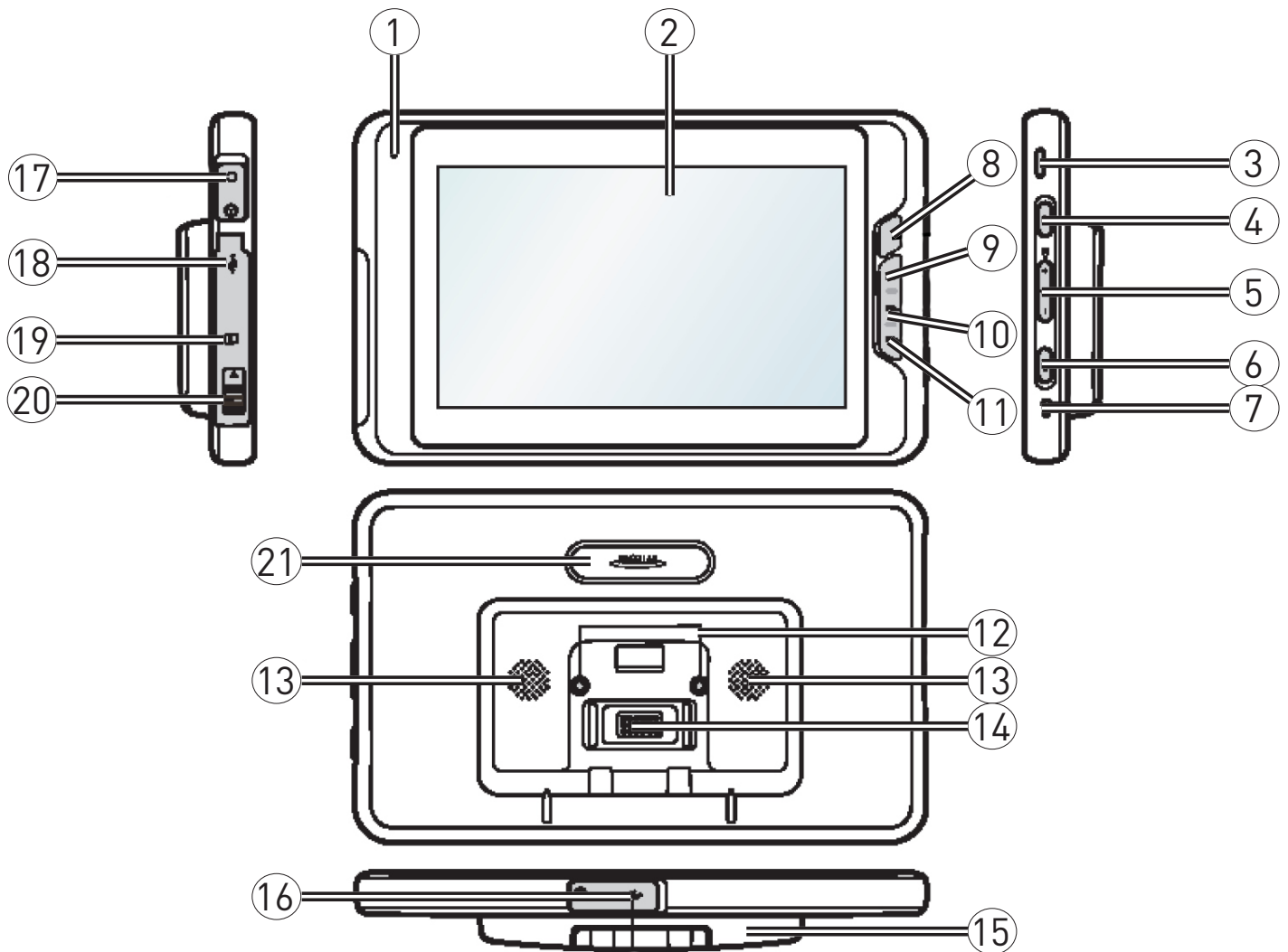

- |                          |                           |                      |
|--------------------------|---------------------------|----------------------|
| 1. Microphone            | 9. BACK button            | 17. Headphone jack** |
| 2. Touchscreen           | 10. HOME button           | 18. USB port***      |
| 3. Lanyard attach point  | 11. MENU button           | 19. Memory card slot |
| 4. POWER button          | 12. Cradle screws         | 20. Cover latch      |
| 5. Volume buttons        | 13. Speakers              | 21. Camera lens*     |
| 6. MUTE button           | 14. Cradle connections    |                      |
| 7. RESET button (unused) | 15. Mount Plate           |                      |
| 8. Camera button*        | 16. Mini-USB Power port** |                      |

\*available on select models.

\*\*use caution when opening to avoid damaging covers.

\*\*\*inactive on TRX7.



# TRX7 Software.

## TRX7 Dashboard Screen

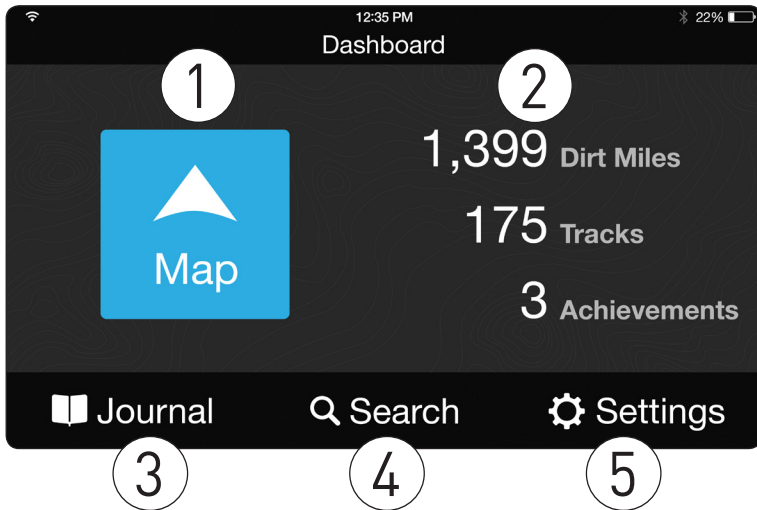

1. **Map:** Tap to open Map screen.
2. **Dirt Miles** traveled, **Tracks** recorded, and **Achievements** earned displayed here.
3. **Journal:** Contains Track Log and Wish List of saved Trails.
4. **Search:** Search for Trails, Tracks, POIs, etc.
5. **Settings:** Edit account, vehicle profiles, connectivity, etc.

## TRX7 Map Screen







6. **Waypoint:** Mark Waypoints while driving or recording a Track.
7. **Social Post:** Share your adventures with a Tweet.
8. **Start/Pause:** Pause tracking or resume tracking.
9. **Backtrack:** Follow active Track back to starting point.
10. **Finish:** Save Track with details and commentary.
11. **Orientation:** Toggle View to North Up or Track Up.
12. **Map Options:** View and modify map display settings.

## 1. Turn On Your TRX7.

Press the Power button on the right side of the device to turn the device on.

## 2. Connect to Wi-Fi.

1. Tap  >  >  **Wi-Fi** from the Home screen.
2. Slide On/Off button to .
3. Tap  **Wi-Fi** again to see networks.
4. Enter password (if applicable) > tap **Connect**.

## 3. Update Software + Maps.

**IMPORTANT:** Go to [trxsupport.magellangps.com](http://trxsupport.magellangps.com) and look up the latest software and system versions before downloading any software or system updates.

Your TRX7 will alert you when a software update is available from Magellan GPS.

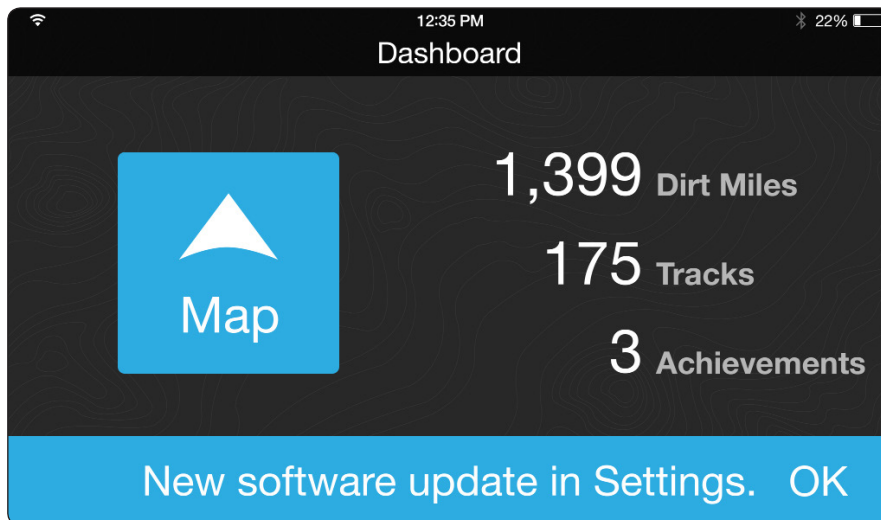

**Note:** Wi-Fi must be **ON** and internet connection must be good to complete updates.

To update the TRX software:

1. Tap  **Settings** from the TRX Dashboard > tap **Software Update**.

**Note:** If this option is grayed out, but you know that a software update is available, turn your unit off and on again, then return to the Settings menu.

2. Tap **Download**. Wait a few minutes for the update to download.



# Get Started.

3. Tap **Install** once the download is complete.
4. Tap **Install** again when you see a notification asking you if you want to install an update to the existing application. Make sure that the **NEW** tab is selected (NOT the ALL tab).
5. Wait a few minutes for the software update to install.
6. Tap **Open** once the app has finished installing.
7. Tap **Start download** when you see a notification that says “Magellan TRX needs to download resources”. Make sure **Download over Wi-Fi only** is checked to ensure a quick update speed.
8. Read the Magellan End-User License Agreement (EULA). Tap **Accept** to continue or **Decline** to halt the update process.
9. Tap **Settings** > **Product Information** to make sure that your unit now has the latest software version installed.

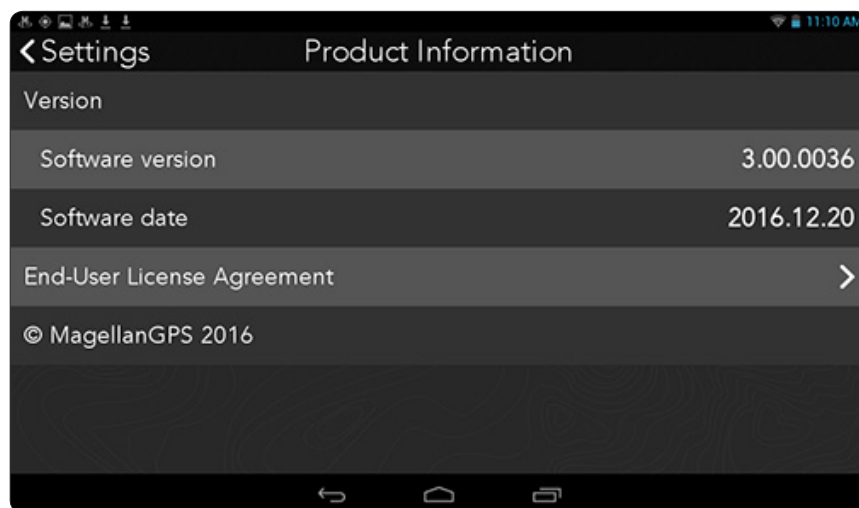

To download new map data when an update is available from Magellan GPS:

1. Tap **Settings** from the TRX Dashboard > tap **Map Update**.
2. Tap the map update package listed in the menu > tap **Update**.

The map update may take 1-2 hours to finish downloading depending on network connectivity speed.

Having issues with software or map updates? Get in touch with us:

**Email:** [trxsupport@magellangps.com](mailto:trxsupport@magellangps.com)

**Phone:** 909-707-9971

**Online:** [trxsupport.magellangps.com](http://trxsupport.magellangps.com)

## 4. Create Your TRX Account.

You MUST create a TRX account for your TRX7 to work properly.

1. Tap **Settings** from the Dashboard > tap **Register New Account**
2. Enter your account details > tap **Register** to create your account.

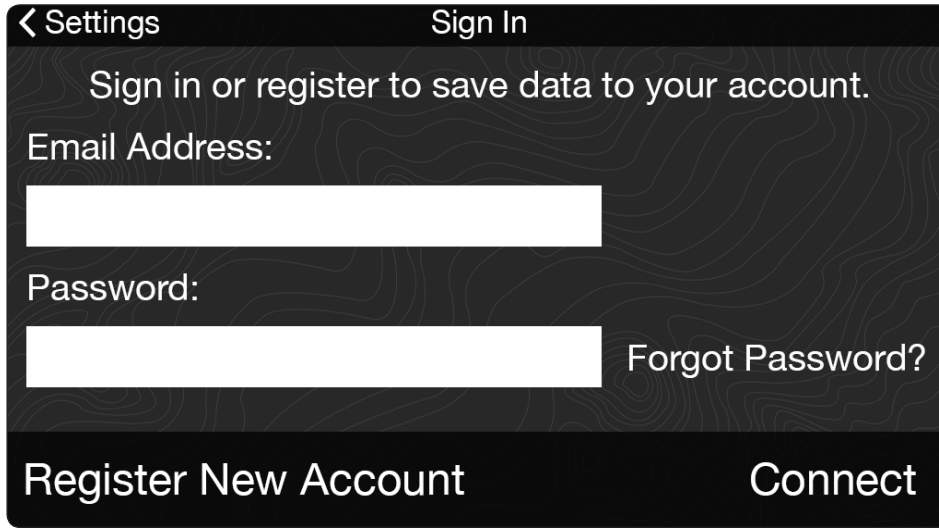

**IMPORTANT:** Use your existing [MagellanGPS.com](https://www.MagellanGPS.com) credentials to create a TRX account.

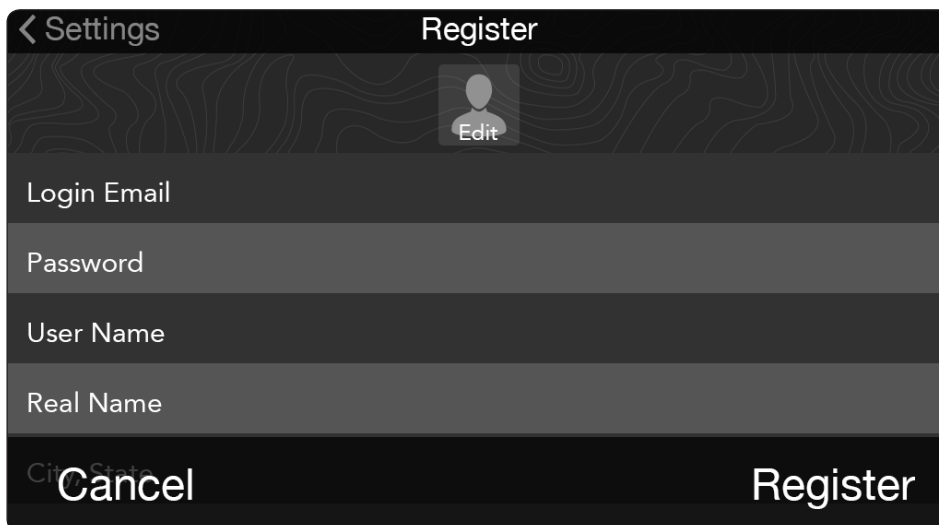

When you create your TRX account, your TRX7 is automatically registered to the account. You'll receive a confirmation email once your account has been created.



# Get Started.

Whenever you need to log in, tap **Account Profile** > enter TRX email address and password > tap **Connect**.

**Note:** A **MagellanGPS.com** account will also be created if you're new to Magellan and you're registering an email address for the first time.

You can also create your TRX account or log in with your account on TRX Trailhead, the TRX online site optimized to search for Trails and organize/publish your Track data:

1. Go to [www.TRXTrailhead.com](http://www.TRXTrailhead.com) > click **Sign In** .
2. Click **Create Account** > enter your account details.

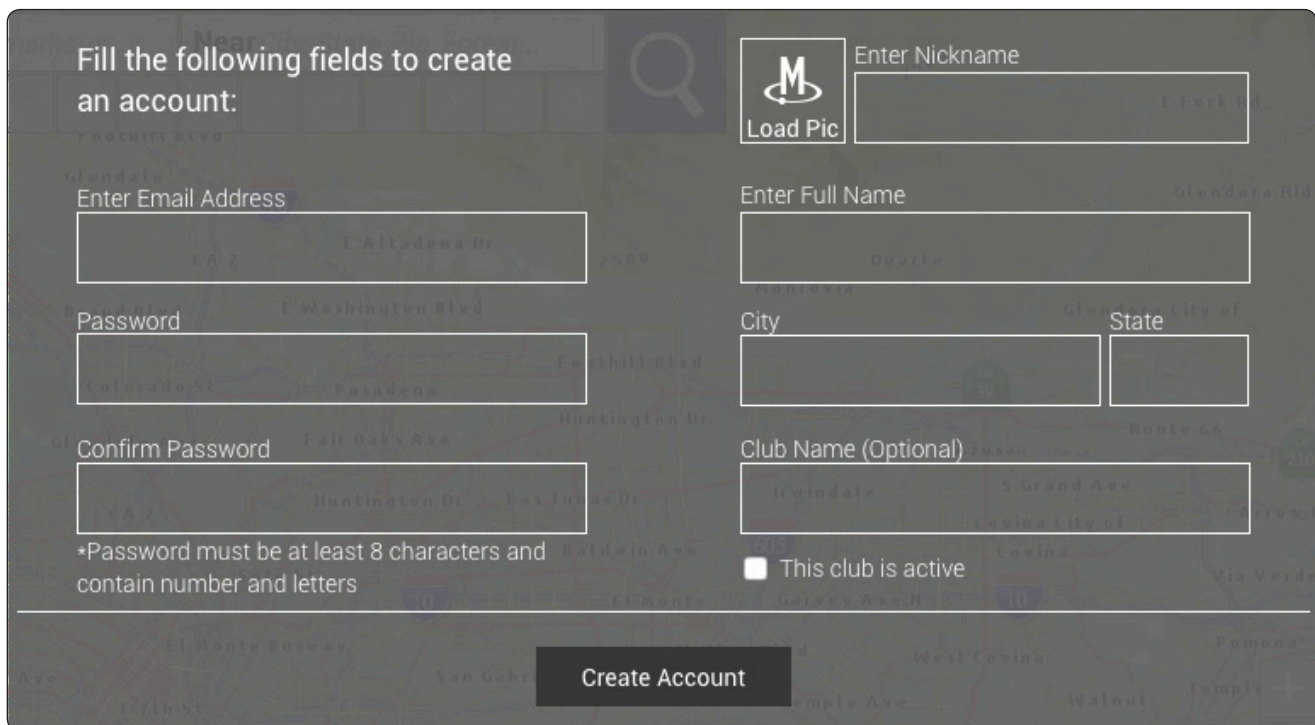



The screenshot shows a registration form with the following fields and options:

- Fill the following fields to create an account:** (Instructional text)
- Enter Email Address:** Text input field.
- Password:** Text input field.
- Confirm Password:** Text input field.
- \*Password must be at least 8 characters and contain number and letters** (Note below the confirm password field).
- Enter Nickname:** Text input field.
- Load Pic:** Button with a magnifying glass icon.
- Enter Full Name:** Text input field.
- City:** Text input field.
- State:** Text input field.
- Club Name (Optional):** Text input field.
- This club is active** (Checkbox option).
- Create Account** (Large button at the bottom center).

3. Click **Create Account** again to confirm your TRX account. Confirmation is sent to your email.

To log in with the account you created on your TRX7:



1. Go to [www.TRXTrailhead.com](http://www.TRXTrailhead.com) > click **Sign In** .
2. Enter account details > click **Sign In** .

To make sure your TRX7 data is synced with TRX Trailhead, go to **Settings** > **Manual Sync** on your TRX7 to keep data synced between your TRX7 and the Trailhead site.

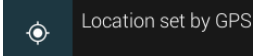
## 5. Get a GPS Signal.



1. Slide your finger downward from the top left corner of the screen.
2. Tap on .

A display screen appears with:

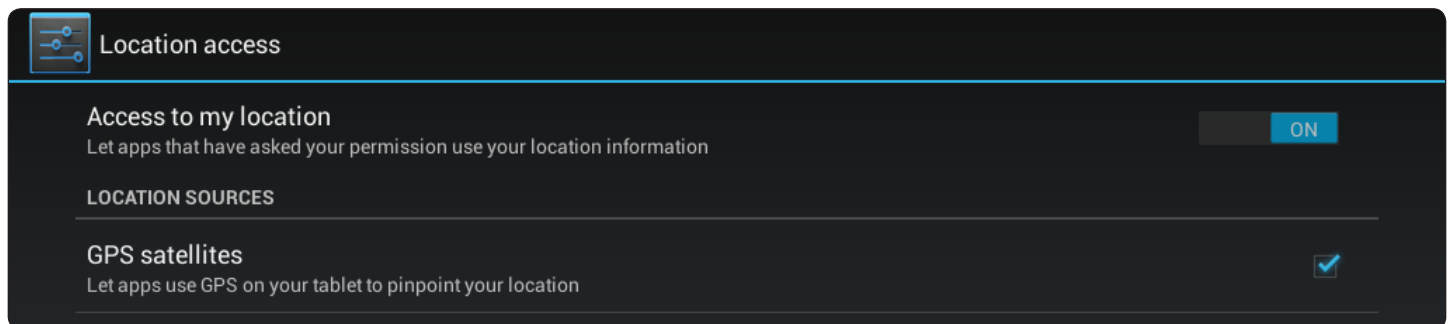
- **Access to my location:** lets device apps use your location information. Tap  to use this function.
- **Location Sources:** indicates the sources that provide your device position (see GPS satellites below).
- **GPS satellites:** lets apps use GPS on your TRX7 to pinpoint your location. This option automatically activates when Location Access is .



Another way to check GPS Status:

1. Slide your finger downward from the top right corner of the screen.
2. Tap  > Scroll down to  **Location access**. This displays the same options described above.

### Important!

Various factors influence GPS signal reception. To improve the signal reception and time to calculate the current location:

- Leave any enclosed structure (garage, parking structures, etc.).
- Make sure you have a 'clear view of the sky'. Buildings and trees can have an impact on GPS signal reception.
- Make sure that the device is mounted where it can have a clear line of sight to the windshield.

**Note:** The first time the device calculates its location can take up to 1 minute. Subsequent times will be 15 seconds on average.

# Get Started.

## 6. Mount the TRX7 in Your Vehicle.

1. Clean the area on the windshield where you want to mount the device. Allow the surface to dry.
2. Attach the mount baseplate to the cradle with the included screws.
3. Attach the mount to the vehicle.\*
4. Plug the device into your Vehicle Power Outlet using the Vehicle Power Adapter (VPA) supplied with your TRX7. Please use ONLY the supplied VPA.

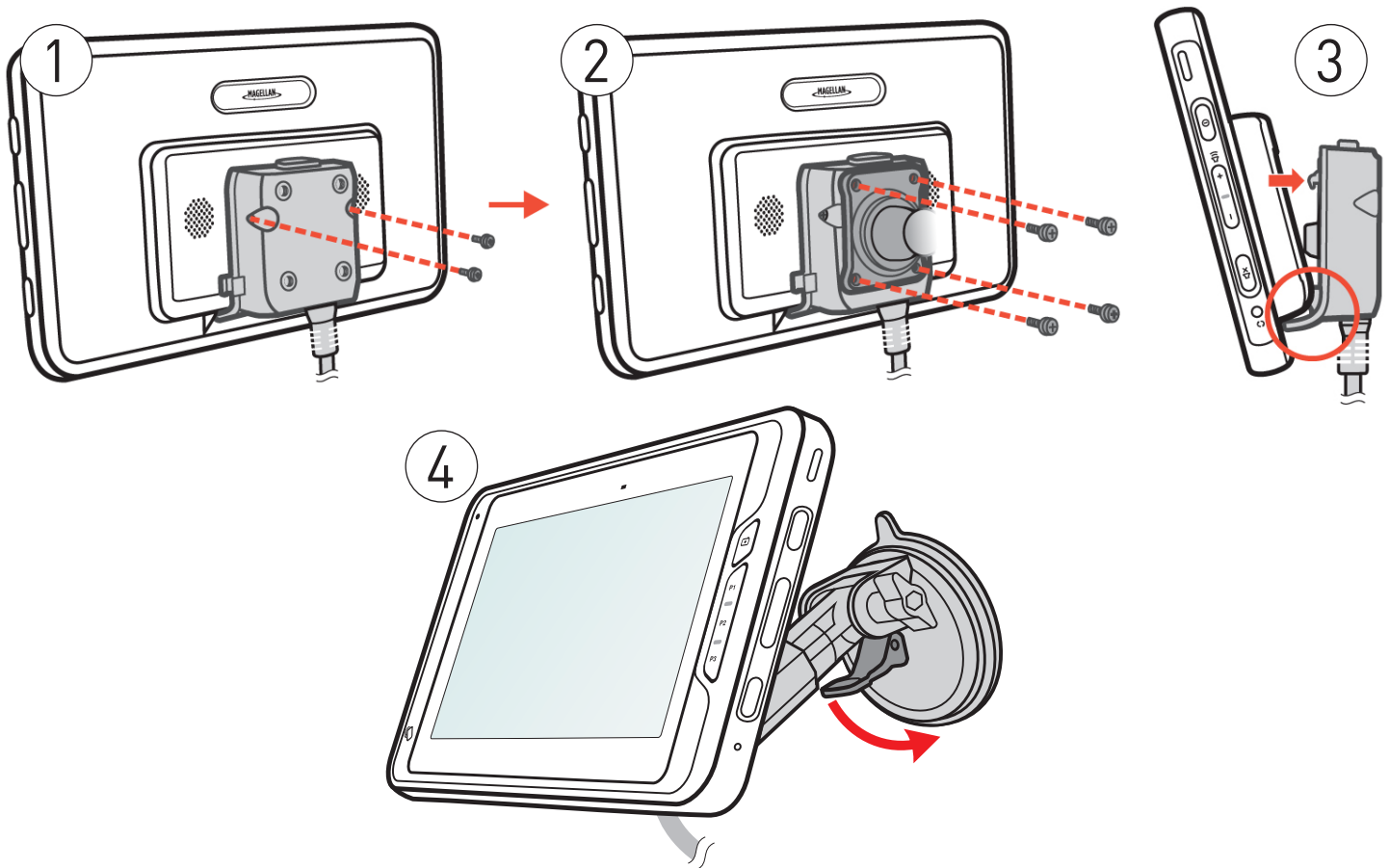

\*RAM suction and U-Bolt mounts both require additional assembly.

**Note:** Go to [trxsupport.magellangps.com](http://trxsupport.magellangps.com) for articles and videos about setting up and operating your TRX7, and get in touch with our Magellan TRX Support team via email at [trxsupport@magellangps.com](mailto:trxsupport@magellangps.com) or by calling 800-707-9971.

## Power On

Press and release the Power button. The Boot screen (with Magellan logo) appears, then the Home screen appears.

## Turn Off Display and Power Off.

Press the Power button to lock the TRX7.

To power the device off completely, press and hold Power button for 3 seconds > select **Power off** from the menu.

From this menu, you can also:

- Turn on Airplane Mode to deactivate Wi-Fi and Bluetooth connections.
- Restart the device.
- Turn on Silent mode to mute sound.

**Note:** You can continue recording Tracks while the TRX7 is in Airplane Mode.

## View the Battery Level Indicator.

The Battery Level is always displayed on the top right corner of the screen, indicated by the  icon based on the percentage of battery life remaining.

1. Slide your finger downward from the top right corner of the screen.

2. Tap . A display screen appears:

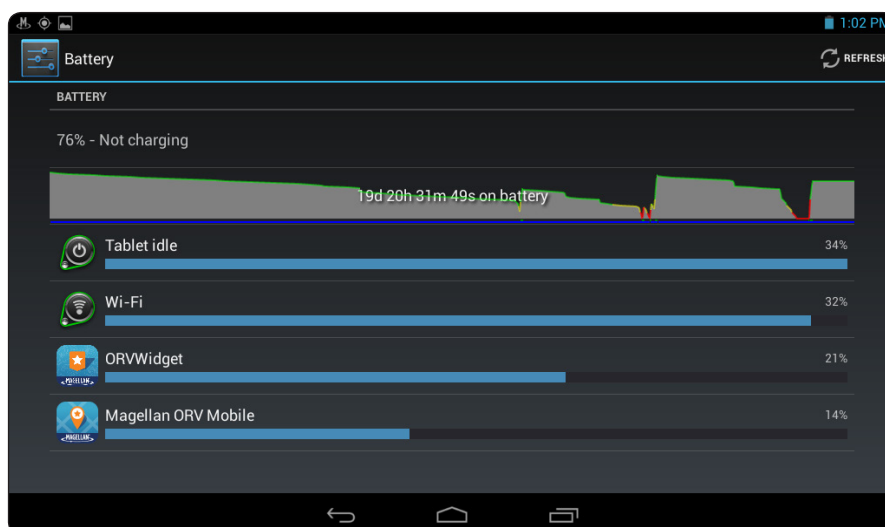

Tap any of these options to display battery use details.





# Get Started.

## Adjust Volume.

Use the two volume buttons on the right side of the TRX7 to adjust volume.

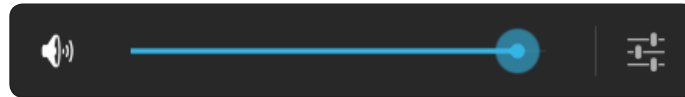
You'll see a volume indicator appear on the screen. Adjust the volume by sliding the circle left (for volume down) or right (for volume up).



Tap  to open a Notification volume indicator. Slide this indicator left and right to adjust notification volume.





## Adjust Brightness.

1. Slide your finger downward from the top right corner of the screen > tap .
2. Slide the Brightness indicator left (lower brightness) or right (increase brightness).



## Set the Date and Time.

1. Tap  >  from the Home screen.
2. Scroll down to **System** > tap **Date & time**.

**Note:** If **Automatic date & time** is checked but the date and time are wrong, tap on this option to uncheck it.

3. Tap **Select time zone** > find your time zone and tap on it.

Your device time should now match the selected time zone. If the time and date are still incorrect, tap **Set time** to manually change the time, and tap **Set date** to manually change the date.

## TRX7 Home Screen.

The Home Screen displays the TRX7 software icon, current time and date, local weather, and other basic functions for your TRX7 unit.



**Magellan icon:** tap the icon to enter the TRX7 software at the TRX Dashboard.

 **Internet browser**  **Android Tools**  **Contacts List**

The **Android Tools** function allows you to configure the Android apps, widgets and settings on the device. Adjustments you make through this function may affect the TRX application, but separate, additional settings are available within the TRX application.

**Note:** Go to [trxsupport.magellangps.com](http://trxsupport.magellangps.com) or email us at [trxsupport@magellangps.com](mailto:trxsupport@magellangps.com) to get in-depth troubleshooting and technical support for your tablet. Tap **Settings** > **Feedback** to navigate directly to the TRX Support site from your TRX7.





**Note:** The TRX7 uses Android 4.2.2 Jelly Bean software. Refer to Android Jelly Bean software documentation for more information.

# Get Started.

Now that you're familiar with TRX7 basics, customize your TRX user profile before you hit the Trail.

## Create Your Vehicle Profile.

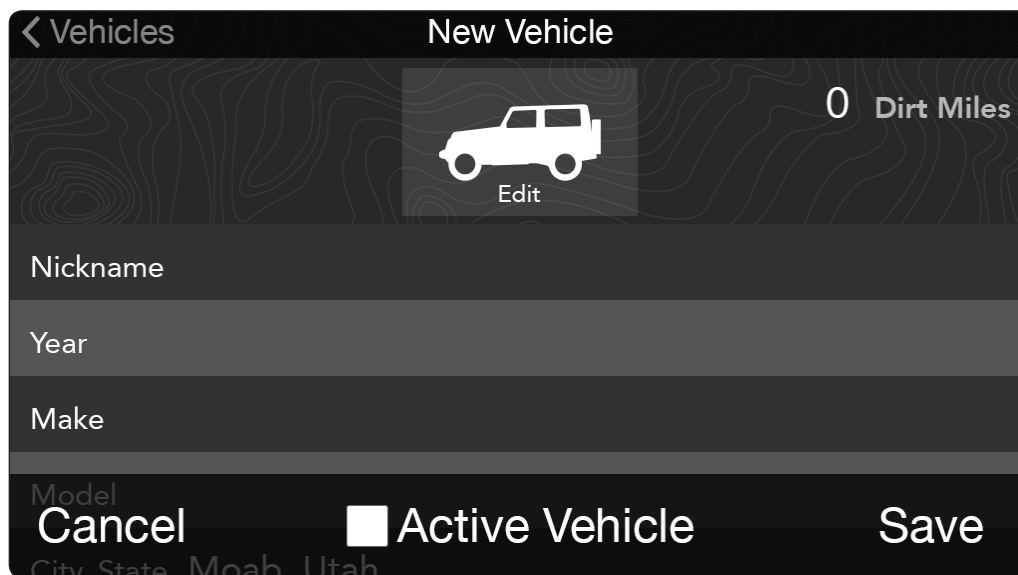

Create a customized Vehicle Profile so that the TRX community knows your vehicle by name (and to show it off).

1. Tap  **Settings** from the Dashboard > tap **Account Profile**.
2. Tap  **Vehicles** > tap  **+ Add Vehicle**.
3. Enter vehicle information: Nickname, Year, Make, Model, and City and State.
4. Tap  **Active Vehicle** if this will be your primary vehicle.
5. Tap  to add a picture of your vehicle from your device (optional) > tap **Save**.



**TRX** Tip: Tap  > **+ Add Vehicle** from the Vehicles page to add other vehicles.

The first vehicle you add is automatically designated as your Active Vehicle. To select a different Active Vehicle:

1. Tap  **Settings** from the Dashboard > tap **Account Profile**.
2. Tap  **Vehicles** > tap on the vehicle you wish to assign as your Active Vehicle.
3. Tap  **Active Vehicle** > Select **OK** when you see the prompt **Change active vehicle?** to confirm the change, or **Cancel** to stop the change.

## Link to Social Media.

Link your Twitter and Instagram accounts to your TRX Account to Tweet your Dirt Miles and share off-roading photos while Tracking using the Social Post (#) button.

### Link Your Twitter Account

To link your TRX7 to your Twitter account:

1. Tap **Settings** from the Dashboard > tap **Social Networks**.



2. Tap **+** next to the Twitter option > tap **Connect**.

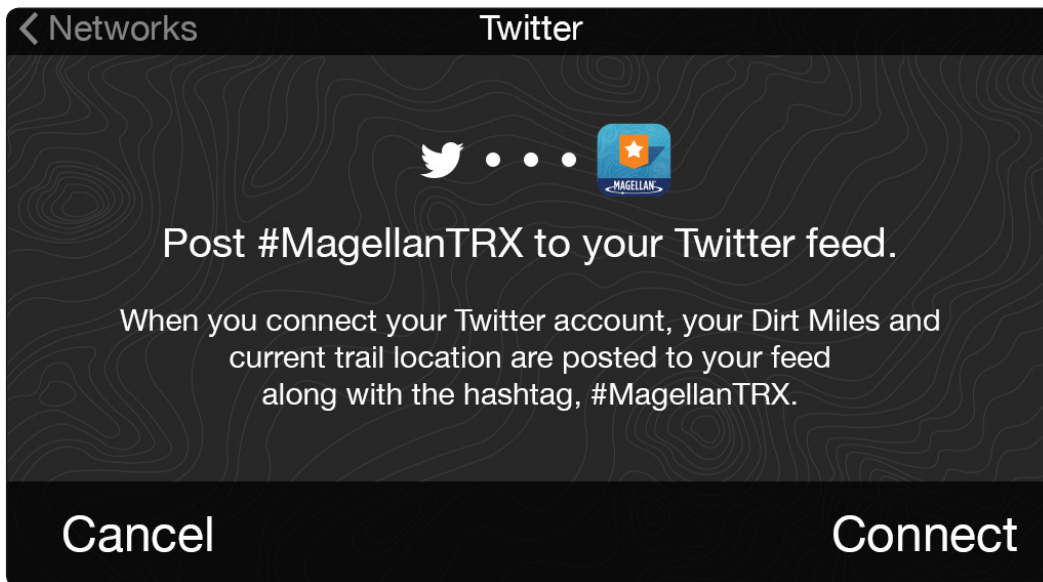

3. Enter account details > tap **Connect** > tap **Done** to finish linking to Twitter.

### Link Your Instagram Account

To link your TRX7 to your Instagram account, tap **+** next to the Instagram option and repeat the steps for linking your Twitter account.



# Go Riding.

## Use Street Navigation.

You can route to any location on the map (Trails, Tracks, POIs, Addresses, and more) on your TRX7 without having to use another navigation device.

To use street navigation on your TRX7:

1. Tap **Search** from the TRX Dashboard.
2. Search for an Address, Trail, or other location that you want to get to.
3. Tap on the desired location from the search results.
4. Tap **GO** to begin routing to an Address, or tap **Save** to add a Trail to your Wish List.
5. Return to the TRX Dashboard > tap **Journal** > **Wish List**.
6. Tap on the Trail you want to get to from your Wish List.
7. Tap **Follow** > **Start to End** or **End to Start**.

Once you begin routing, you'll automatically be given visual and audible turn-by-turn navigation instructions to the Trail. To cancel your route, tap **X** on the top right of the screen > tap **YES** to cancel the route.



**TRX** Tip: Tap on the Estimated Duration box (to the bottom right of directions at the top of the screen) to view your current MPH, Elevation, and Direction of Travel.

**TRX** Tip: Tap on the navigation icons on the top left of the screen to view a list of upcoming turns and maneuvers.

## Tracking.

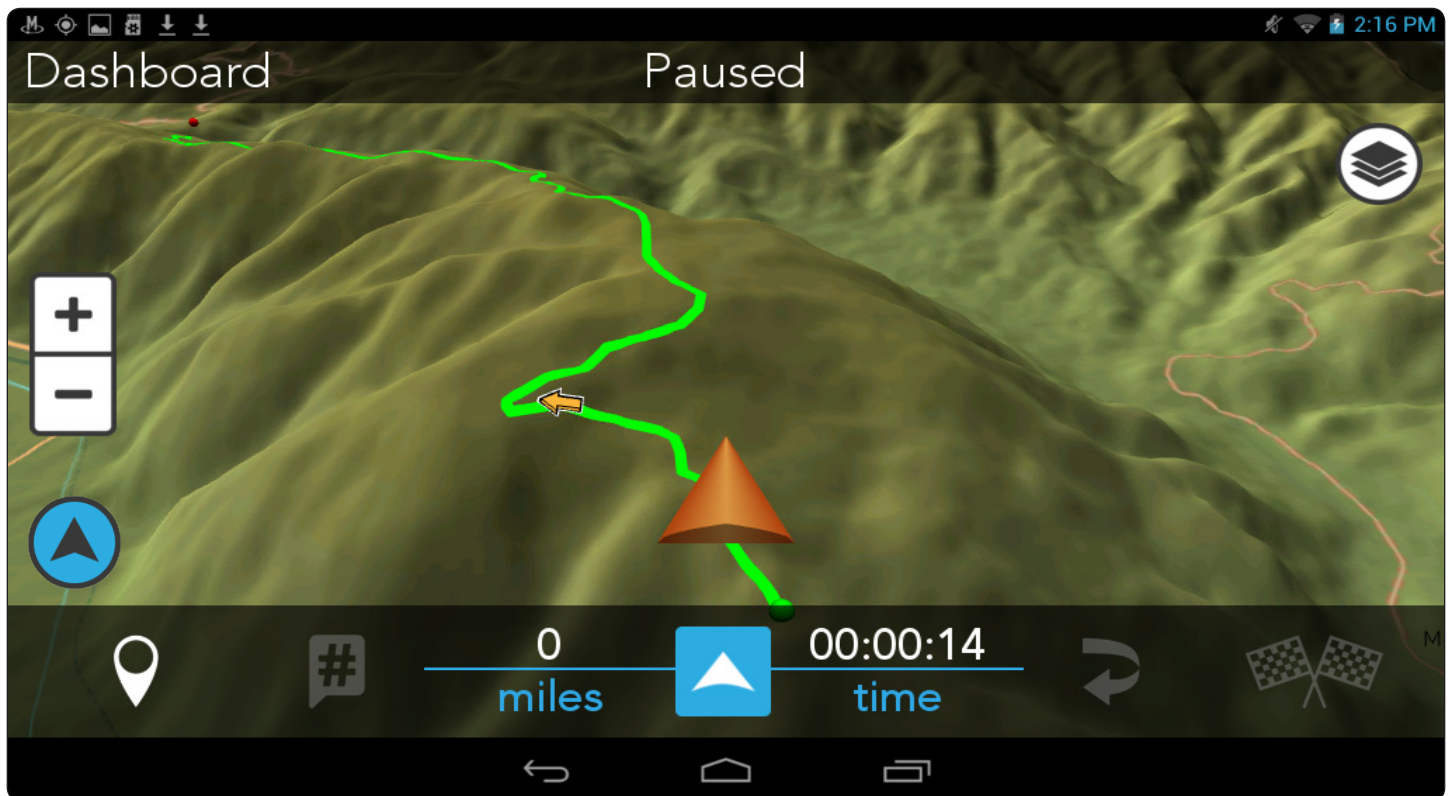

To track your progress from any location:

1. Tap  from the Dashboard to get to the Map screen.



2. Tap  to start tracking > tap  to pause tracking at any time.

On the Active Map screen, you can:

-  Mark a Quick Waypoint.
-  Customize map view.

**Note:** Go to **Settings > Map Display** to configure your default Map View and Orientation as well as to toggle the North Up and Zoom buttons on and off.

**TRX Tip:** Tap  to snap the map view back to your current location after you've panned around the map.

# Go Riding.

## Change Map Options

Tap  to customize your map view:

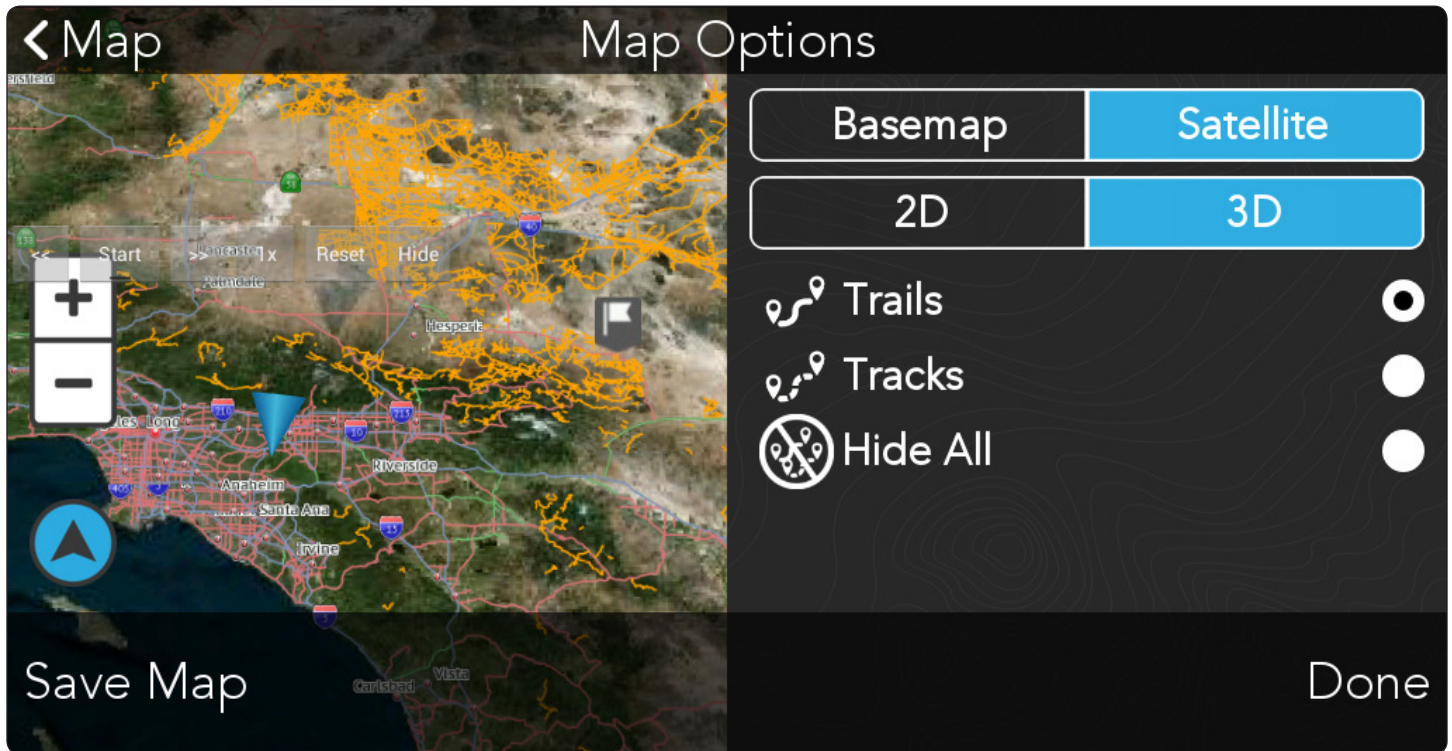

- Tap **Basemap** for the default topo map view, and tap **Satellite** for satellite map imagery from DigitalGlobe.\*
- Tap **2D** for a 2D map view, and tap **3D** for a 3D map view.
- Tap **Trails** to view authorized Trail data on the map view.
- Tap **Tracks** to view user-generated Tracks on the map view.
- Tap **Hide All** to hide map content from the map view.
- Tap **Save Map** to save satellite imagery from the current map view to your device for use outside of network coverage (e.g. Wi-Fi, 3G, 4G, 5G, etc.).\*
- Tap **Done** to return to the Map screen.

\*You must have a DigitalGlobe subscription before you can access satellite imagery on your TRX7. Refer to **Using Satellite Imagery** for instructions on subscribing to DigitalGlobe on your TRX7 as well as viewing and saving satellite imagery.



Pausing the Track displays more options.

 **Detail Waypoint:** Record an Audio Waypoint, select Waypoint type at Current Location, mark Point on Map, or Enter Waypoint using Coordinates.

 **Social Post:** Tweet Dirt Miles from your current Track.

 **Backtrack:** Follow your Track back to starting point.

 **Finish:** Save customized Track.

## Mark Waypoints.

Whether a challenging Trail or a leisurely ride, Waypoints let you add detail to your Tracks and to any environment with customizable Waypoint options so that you and other off-roaders can learn more about an area before heading to the Trail.

You can save Detail Waypoints while free-driving on the Map, and both Quick Waypoints and Detail Waypoints while Tracking.

All Waypoints saved while free-driving are added to your Log, and all Waypoints saved while Tracking appear on your Track after you've finished and save it to your Log.

To save a Waypoint while tracking:

1. Tap  > tap Waypoint type > tap **Save**.

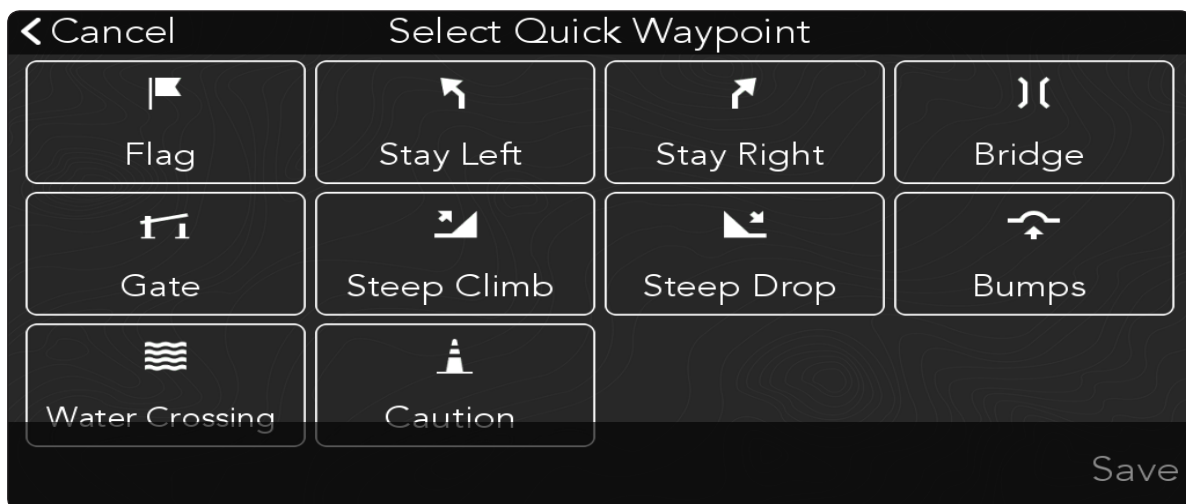

2. Choose applicable Waypoint sub-type.

3. Tap **Save** to save Waypoint to your Track, or tap **< Cancel** to return to your Track.



# Go Riding.

To save a Detail Waypoint:

1. Tap **||** to pause your Track > tap .
2. Tap Detail Waypoint option.

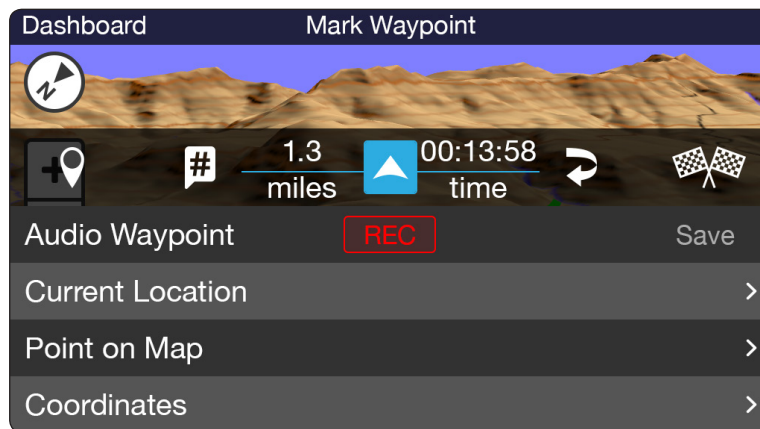

**Audio Waypoint:** Record custom audio message.

1. Tap **REC** > record your message.
2. Tap **Save** to save Audio Waypoint.

**Current Location:** Select Waypoint for your location.

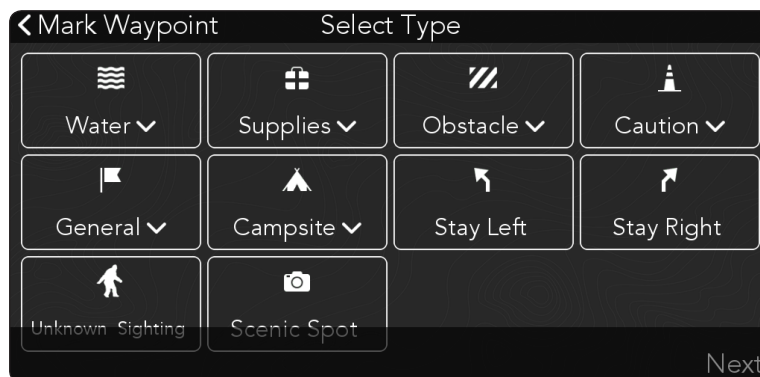

1. Tap Waypoint type > choose applicable Waypoint sub-type > tap **Next**.
2. Enter Waypoint name and comment.
3. Tap **Save** to save the Waypoint to your Track, or **< Info** to return to the Detail Waypoint options.

To add a photo to a Detail Waypoint:

1. Press Camera button\* while tracking or paused.

\*available on select models.

2. Use the Camera to take a photo. The photo is added to your photo gallery.
3. Pause your Track > tap  > **Current Location** > tap Waypoint type.
4. Tap **Add Photos** > select a photo.
5. Tap **Add Photos** to add photos from the gallery to a Waypoint.

**TRX Tip:** You can also add photos to Waypoints on TRX Trailhead after saving your Track to your Log.



**Point on Map:** Tap on the map to save a Waypoint in a specific location. You can also view a list of nearby Waypoints when you save a Waypoint on the map.

**Coordinates:** Enter Latitude/Longitude coordinates as a Waypoint.

## Social Post.

Tweeting from your Track lets your friends and other off-roaders know where your location and how many Dirt Miles you've driven.

To Tweet from your Track:

1. Tap  to pause your Track > Tap .
2. Tap  when you see the message **This will post upon connection.** (if not connected to Wi-Fi).

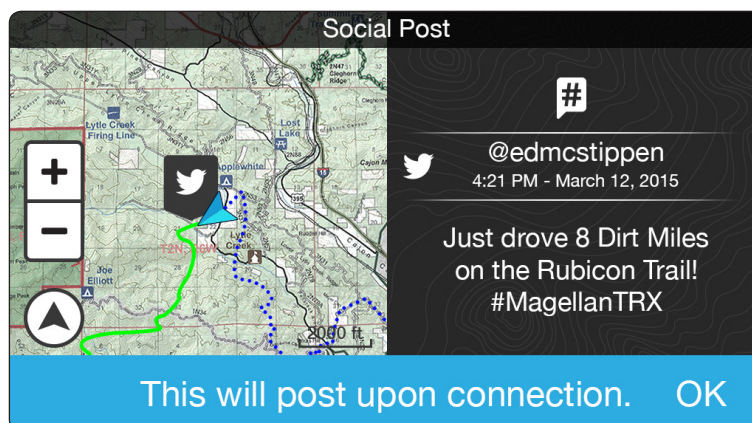

3. Tap .

# Go Riding.

## Backtrack.

Follow a Track back to the starting point:

1. Tap . You'll see this notification:



2. Tap **OK** to begin Backtracking, or **Cancel** to return to the Pause screen.

While Backtracking, you'll see a line with arrows moving to the start of your Track.

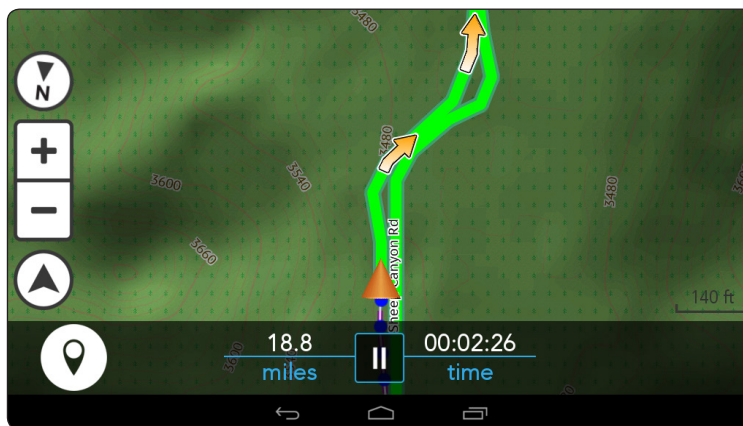

**WARNING:** Use Backtracking with caution. Direction of travel can affect Route difficulty.

## Finish (Save) Your Track.

When you've finished Tracking, save your Track to your Log.

Note: You must follow these steps in order to save any Track that you've recorded. If you turn off the unit before saving, you will lose your Track data.

1. Tap  > tap  > enter Track attributes.

2. Tap **Name** to type in a Track name.



3. Tap a 4WD (four-wheel drive) option.



4. Tap a 4LO (low-gear) option.



5. Tap a Terrain type.



6. Tap Terrain information.

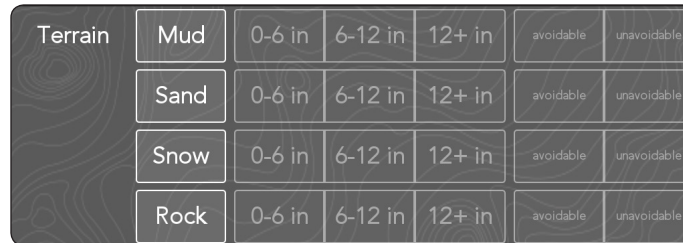

7. Tap Pitch, Tilt, and 1-5 Star Rating.

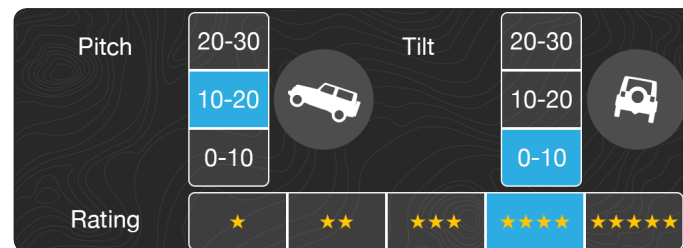

8. Tap **Comment** to write Track details.



9. Tap **Save** to save your Track, or **Discard** to stop saving your Track.

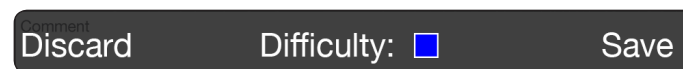

**TRX** **Tip:** Your selections assign one of four Difficulty levels to your Track:

- Easy
- Intermediate
- ◆ Advanced
- ◆◆ Expert only

When you've saved a Track to your account, you can view and edit the Track's route, Waypoints, and attributes in your Log. You can also share your Track with the TRX Community on TRX Trailhead.

**Note:** Entering Track details is optional at the time of saving, but is mandatory before sharing the Track on TRX Trailhead.



# Go Riding.

## Use The Journal.

The **Journal** (accessible from TRX Dashboard) contains your saved items in two lists:

**Log**: Contains your completed Tracks in chronological order, with the most recent saved Track at the top.

**Wish List**: Contains Trails, Trips, and Waypoints that you've saved.



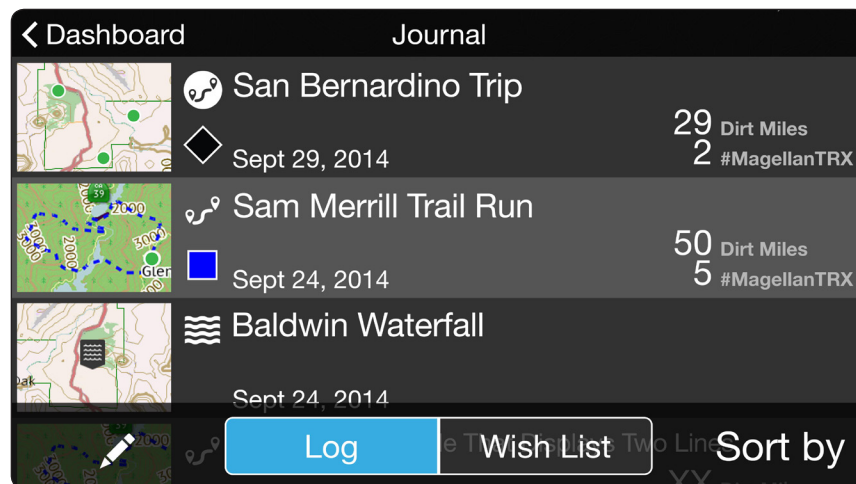

## Create A New Trip

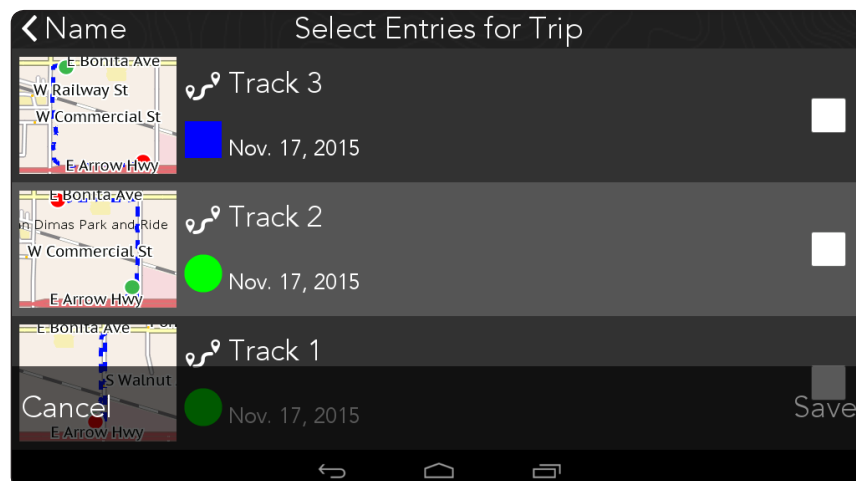



1. Tap  > **+ New Trip**.
2. Type a name for the Trip > tap **Done**.
3. Check each Track or Trail you want to add to the Trip > tap **Save**.

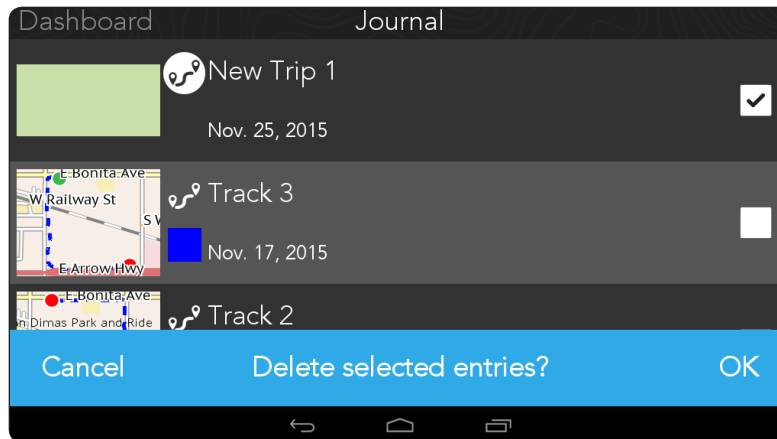

## Delete A Trip

1. Tap  > tap the check box next to each Trip you want to delete > tap .
2. Tap  to delete the Trip, or  to return to your Log or Wish List.



To go to a Trail or POI that you've saved to your Wish List, tap an item on your Wish List > Tap .

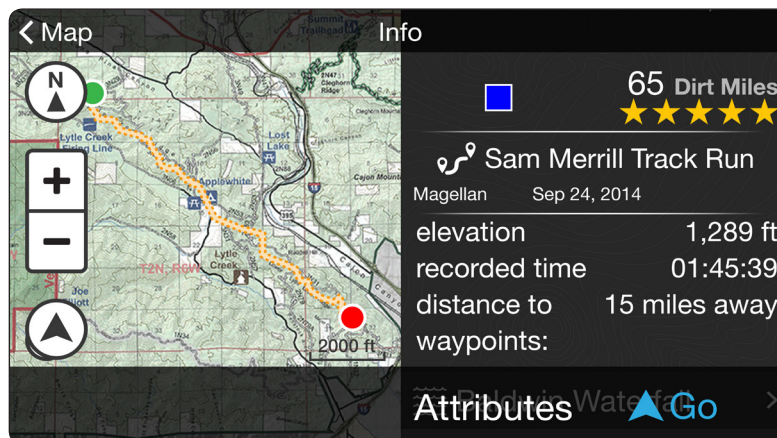

To follow a Trail from your Wish List:

1. Tap an item on your Wish List.
2. Tap , then tap  or  to ride a Track or Trail.
3. Follow the arrows to ride along the Track or Trail.

**TRX** Tip: You'll receive audio guidance when following official TRX Basemap Trails, but not on user-generated Tracks.

# Go Exploring.

## Search For Map Content.

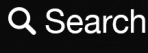
Tap  Search to search through the TRX7 Basemap of over 100,000 preloaded Trails in addition to user Tracks, POIs, OHV Attractions, and more.

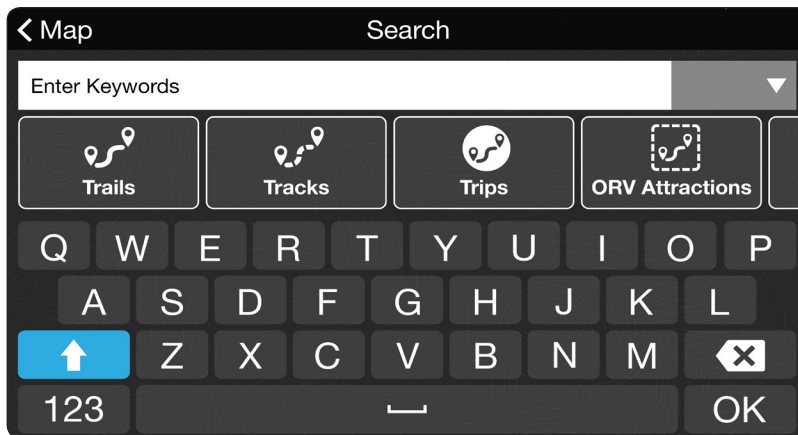

Search by keyword or from the menu:

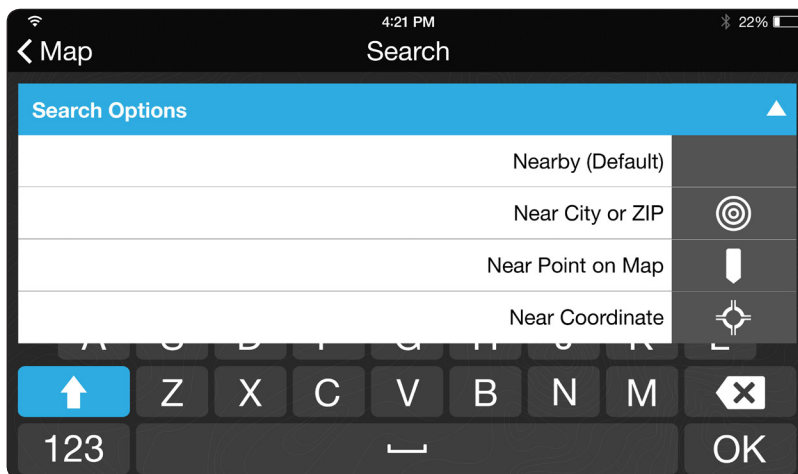

Search by category:



: search for official TRX7 Trails.

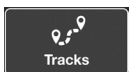

: search for TRX user-recorded Tracks.

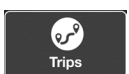

: search for TRX user-recorded Trips.

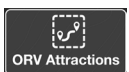

: search for OHV parks.

Tap **OK** to populate the map with results related to your search.

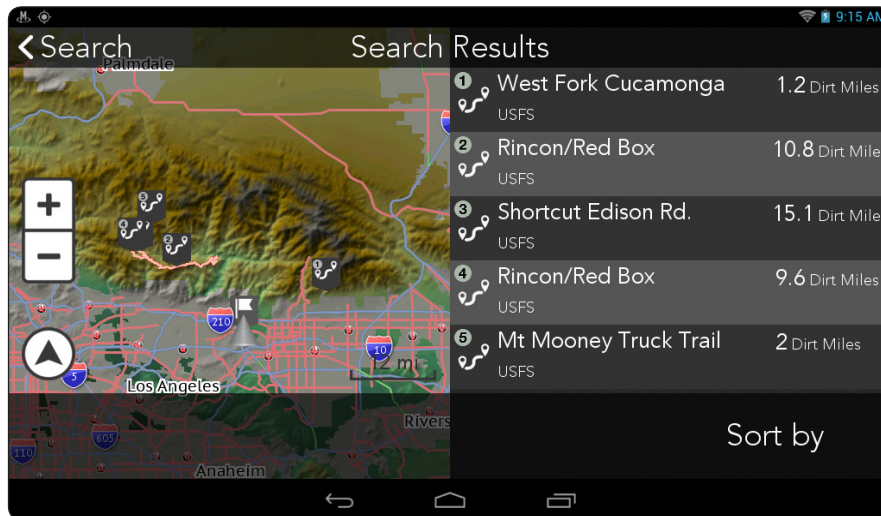

Tap **Sort by** to refine results > choose a sorting option.

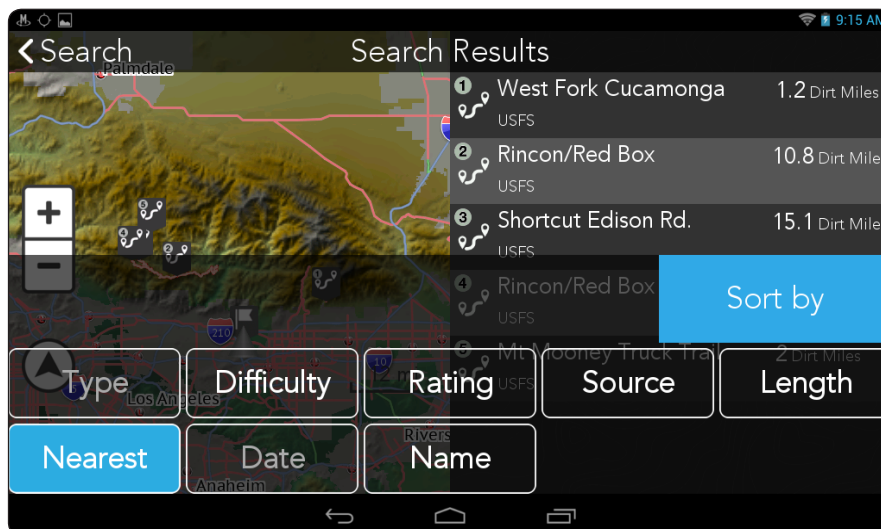

Tap **Sort by** again to refine your search results on the map.

**TRX Tip:** Searching by cities or regions (e.g. Moab, Rubicon) in the keyword search can help expedite your search for specific Trails.

# Go Exploring.

## View and Save Searched Items

You can save items from your search results to your Wish List.

1. Tap on a Marker Label on the Map to see an item's attributes.



2. Tap **Save** to save the item to your Wish List.
3. Tap **OK** to confirm.

Trail Saved to Wish List OK

## Use Satellite Imagery.

You have several options for saving satellite imagery to your TRX7 so that you can access the satellite imagery associated with that map area even when you're outside of network coverage.

### Notes

- You must have a DigitalGlobe subscription before you can access satellite imagery on your TRX7.
- You must have a strong, reliable Wi-Fi connection to download satellite imagery. Satellite images are saved to large files and can take a long time to download using a weak Wi-Fi connection.
- DigitalGlobe only permits you to download up to 2GB per day to your TRX7



## Purchase a DigitalGlobe Subscription.

**IMPORTANT:** You do NOT need to download VantagePoint or any other additional software to use DigitalGlobe on your TRX7.

To purchase the subscription from your web browser:

1. Tap **Settings** from the TRX Dashboard > tap **In-App Purchases**.
2. Tap the **1 Year of DigitalGlobe Satellite Maps** option > tap **\$29.99** on the right side of the screen. When prompted, tap **OK** to be redirected to the URL in the next step.
3. Go to the following URL in your desktop Internet browser:

<http://www.magellangps.com/Store/Satellite-Imagery/Digital-Globe-Satellite-Imagery>

Make sure you're signed into MagellanGPS.com with your TRX account email address and password and that you've already registered your TRX7.

4. Select **Magellan eXplorist TRX7 - Product Registration** from the drop-down menu > click **Add to Cart**.
5. Go to the shopping cart and click **Proceed to Checkout** when you're ready to check out.
6. Enter your address, billing, and payment information > click **Continue**.
7. Read the Terms and Conditions > click the check box next to **I have read and agree to the Terms and Conditions** to proceed.
8. Click **Submit Order** to complete the order.
9. Check your email for a confirmation email. Please save this email for your records.

Once you've purchased the subscription, DigitalGlobe satellite imagery will be available on your TRX7 and on [www.TRXTrailhead.com](http://www.TRXTrailhead.com). Go to **Settings > In-App Purchases** to verify that the subscription has been successfully purchased.

**Note:** You may need to restart your TRX7 in order to refresh the software and begin using your DigitalGlobe subscription.

# Go Exploring.

## Save Satellite Imagery from the Map Screen.

1. Tap **Map** from the TRX Dashboard > tap **Map Options** in the top right of the screen.
2. Toggle to the **Satellite** option > tap **Save Map** on the bottom left of the screen.
3. Zoom out on the map view on the left side of the screen until you see the entire map area that you want to save OR until the Size exceeds the Max limit.
4. Tap **Next** > Enter a name for the map area > tap **Save**.
5. Go to **Settings** > **Map Save** > **Saved Maps** to view all saved map areas. Tap the **Pencil (Edit)** button to delete imagery from your saved areas.

## Save Satellite Imagery Automatically.

1. Go to **Settings** from the TRX Dashboard > **Map Save**.
2. Tap the check box next to Automatic Satellite Map Save to turn it **ON** (checked) or **OFF** (unchecked).

When this option is checked, your TRX7 will automatically download satellite imagery for all current Wish List items next time you save a map area to your Wish List.

Now, you can automatically save satellite imagery in a map area around a Trail, Track or other map content from the Search function:

1. Tap **Search** from the TRX Dashboard.
2. Search for a **Trail, Track**, or other map content > tap on an item from the search results to open the Attributes page .
3. Tap **Save** to add the item to your Wish List.

Satellite imagery in the map area around the item will be available when you travel to that location using your TRX7, even without network coverage.

**Note:** Satellite imagery is saved to the TRX7's internal storage. To save space, delete all unused satellite map areas from your Saved Maps once you've finished using them.

To delete satellite Imagery:

1. Go to **Settings** from the TRX Dashboard > **Map Save** > **Saved Maps**.
2. Tap the **Pencil (Edit)** button.
3. Check the box next to the satellite imagery that you wish to remove.
4. Tap the **Trash Can** button to delete the selected imagery.

## Use TRX Trailhead

TRX Trailhead allows you to instantly see all 100,000+ Trails in the TRX Basemap to quickly search for Trails for your Wish List. You can also edit/review Tracks in your Log, edit Waypoints, search for user Tracks, and publicly share your Tracks.

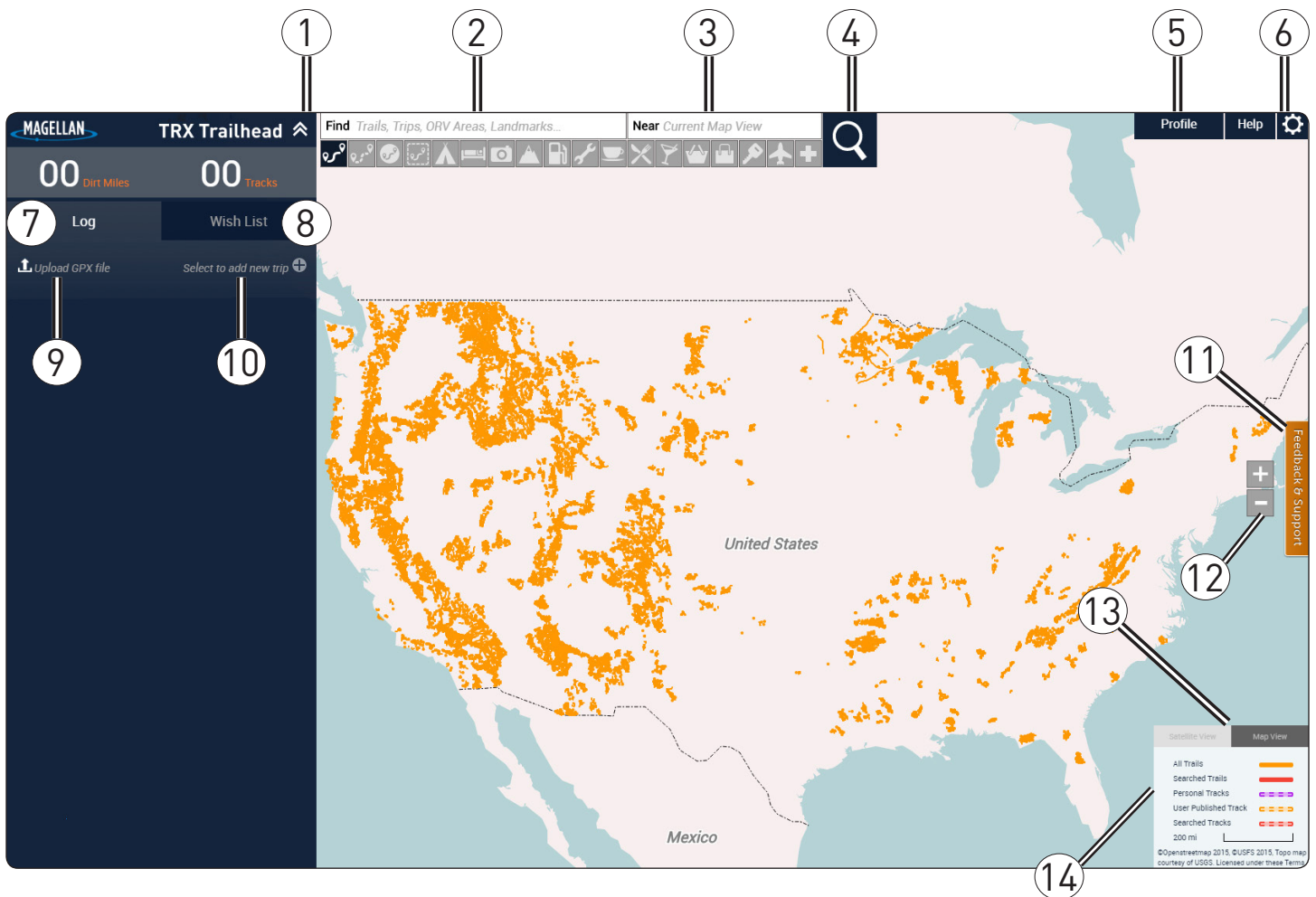

- 1 Minimize Log/Wish List.
- 2 Enter Search Terms.
- 3 Enter Location Criteria.
- 4 Search Button.
- 5 View Profile.
- 6 View Page Settings.
- 7 Access Personal Log.
- 8 Access Personal Wish List.
- 9 Upload GPX File.
- 10 Create New Trip.
- 11 Contact TRX Support.
- 12 Zoom In/Out.
- 13 Change Map View.
- 14 Map Content Key.

# Use TRX Trailhead.

## Sign In to TRX Trailhead

1. Go to [www.TRXTrailhead.com](http://www.TRXTrailhead.com).
2. Click .

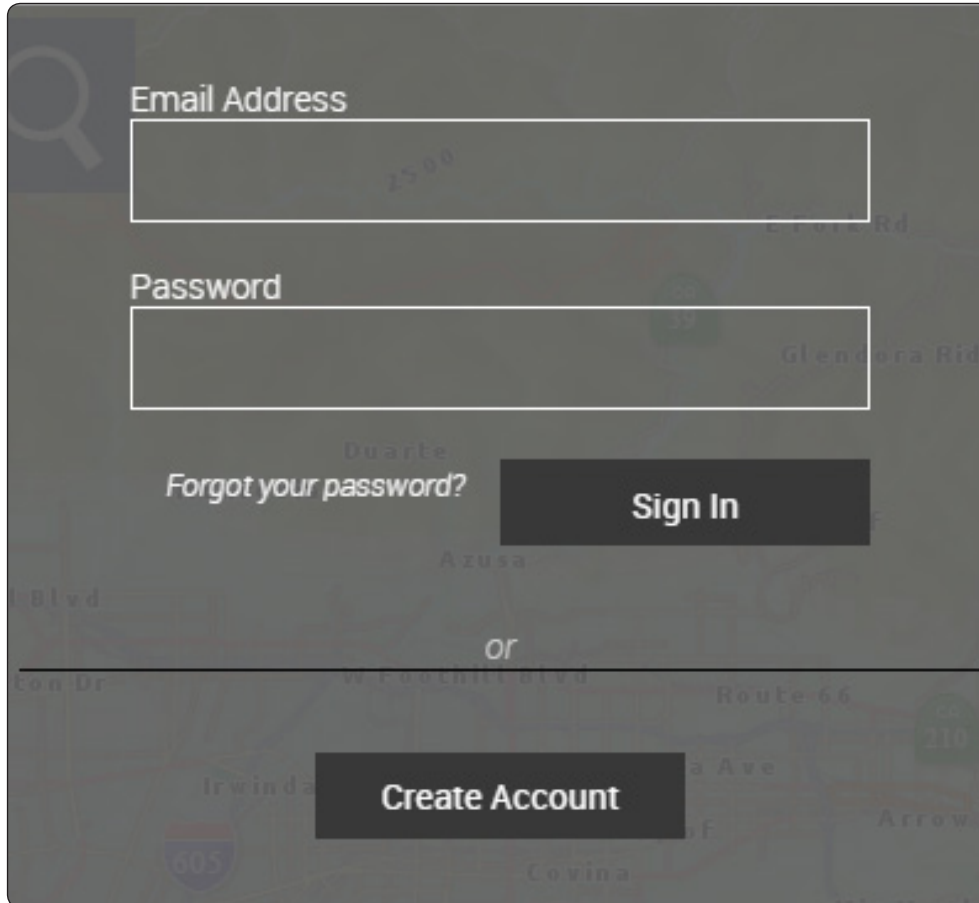

Email Address

Password

[Forgot your password?](#) **Sign In**

or

**Create Account**

3. Enter your account details.
4. Click .

**Note:** Refer to **Create Your Account on TRX Trailhead** for information about registering on TRX Trailhead.

If you forget your TRX account password, use TRX Trailhead to reset it:

1. Click **Forgot your password?** > enter your TRX email address > click **Send**.
2. Go to the email inbox associated with your TRX account > click the link in the email you receive from [noreply@mytrxjournal.com](mailto:noreply@mytrxjournal.com).
3. Enter a new password > click **Continue** to reset your password.

# Use TRX Trailhead.

36

Once you've logged in, you'll see two tabs for your Wish List and Log.

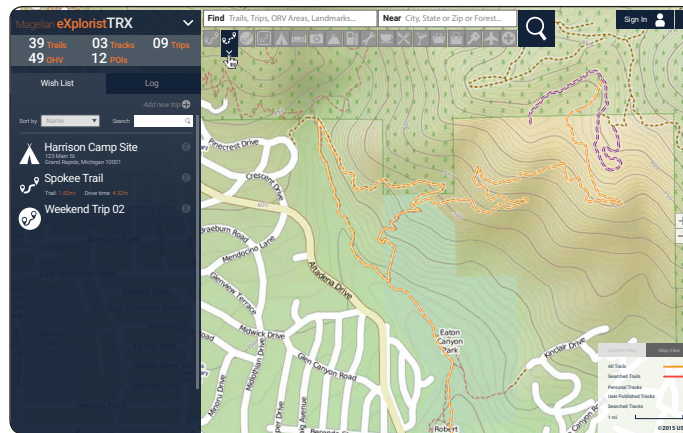

**TRX** Tip: Click **Profile** on the top right of the screen to:

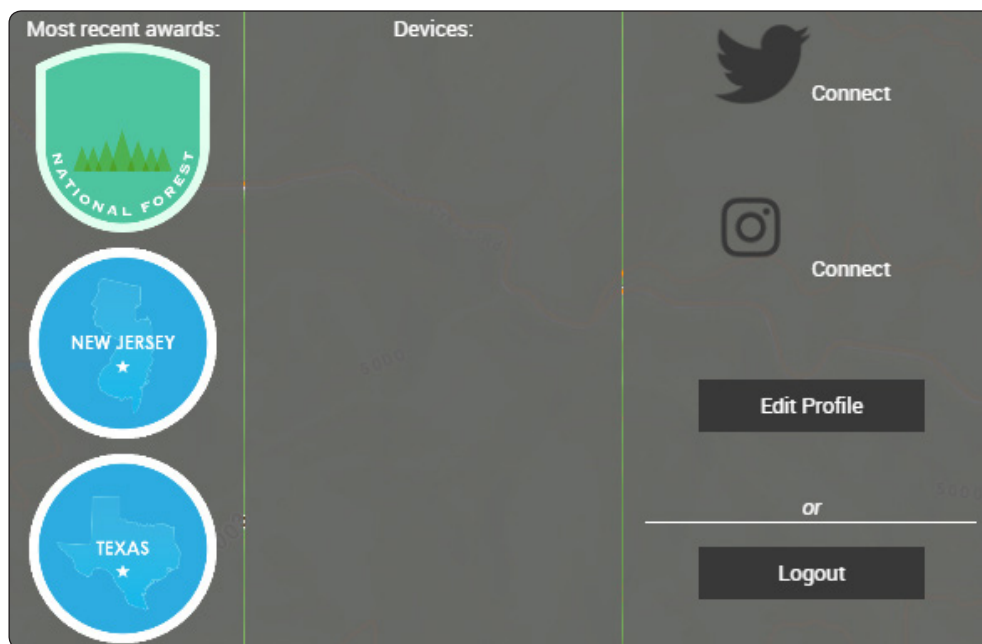

- View recently earned achievements.
- View devices registered to your account.
- View In-App Purchases.
- Connect your Account Profile to Twitter and Instagram.
- **Edit Profile**: Edit Account Profile.
- **Logout**: Log out of TRX Trailhead.



# Use TRX Trailhead.

## Wish List and Log

Access your Wish List and Log by clicking on the tabs on the left side of the screen. Click Tracks, Trails, or Waypoints in your Log or Wish List to view details on the Map.

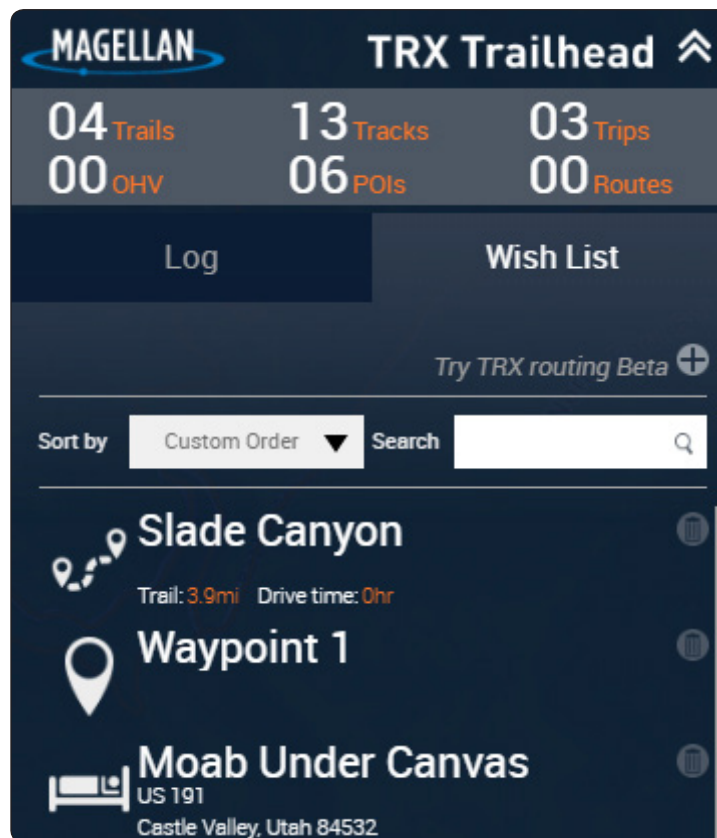

To delete items from your Journal:

1. Click  next to the item.
2. Click **Delete** to delete the item, or **Close** to stop the deletion.



Select any saved Tracks or Trips in your Log to view details, including Start and End Elevation and Terrain Specs. You can modify Terrain Specs from a saved Track or Trip.

**TRX** **Tip:** After you've selected an item, click the **Click to generate share link** option to generate a link to send via email to others who may be interested in that map item.

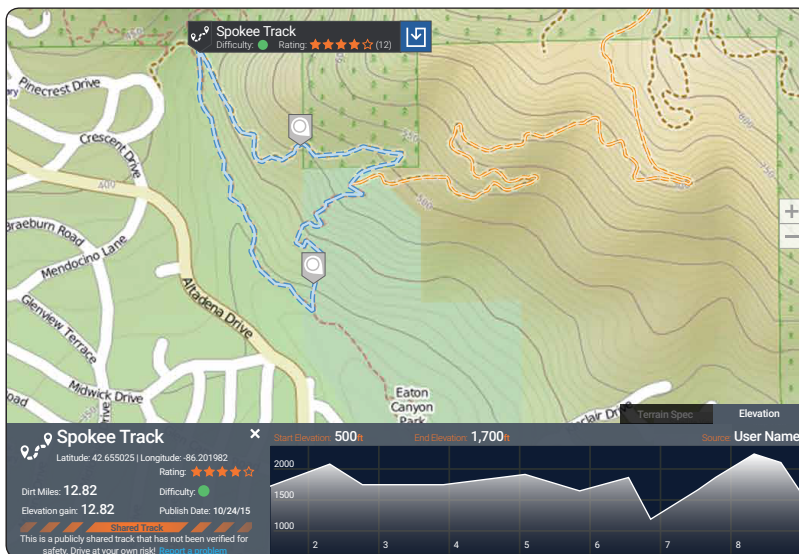

To publish Tracks, Waypoints, or Trips from your Log to the TRX community:

1. Click on the item you wish to publish > review item details to ensure data accuracy.
2. Add **Notes:** to describe the item > edit Review rating (from 1-5 Stars).
3. Click **Publish**. A window appears asking you to confirm sharing.

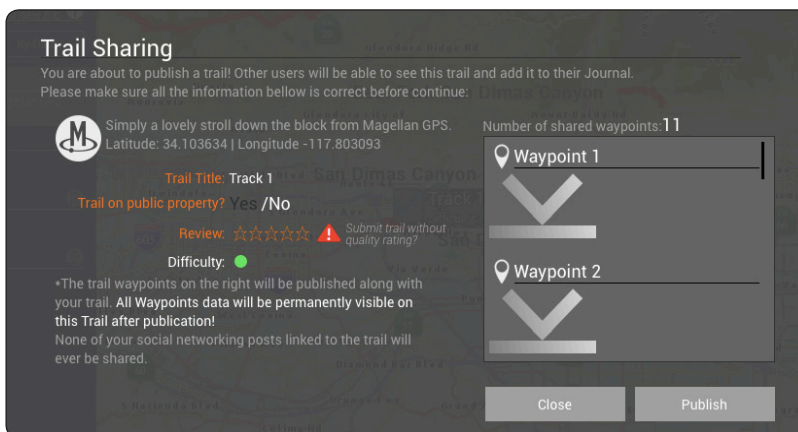

4. Click **Publish** to publish the item, or **Close** to cancel the action.

Once your item is published, it's visible to you and the TRX community.

**WARNING:** You cannot remove a published Track from the basemap. Please verify that item details are accurate. Describe any safety concerns before publishing an item.

**TRX Tip:** Unlike with TRX authorized Trails added to your Wish List, you cannot receive visual or audible Trail Guidance on user-generated Tracks.

# Use TRX Trailhead.

## Search for Trails, Tracks, Trips, OHV Attractions, and POIs.

To search for an item in TRX Trailhead:

1. Click an items from Search options at the top of the page.

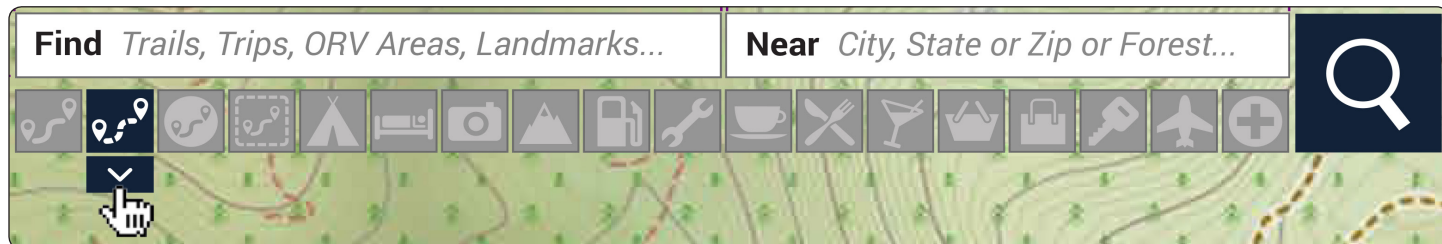

**TRX** Tip: Click on the user **Tracks** or **Trips** icons to filter your search results.

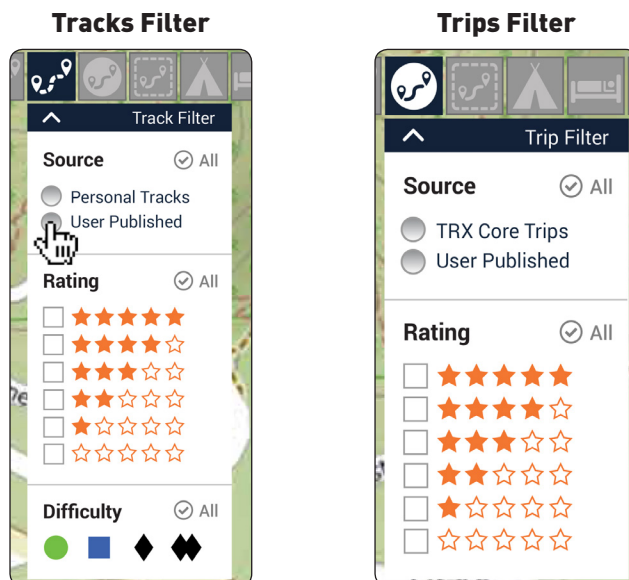

**TRX** Tip: Click the blue sphere next to a city name to highlight Trails within a roughly 50-mile radius of that city.

5. Type a search term in the **Find** text box (e.g. Beaver, Creek).
6. Type a search term in the **Near** text box (e.g. Moab, 84532, etc.).
7. Click  or press Enter to search.

The Map populates with matching results. If you selected Trails, they appear red on the map.



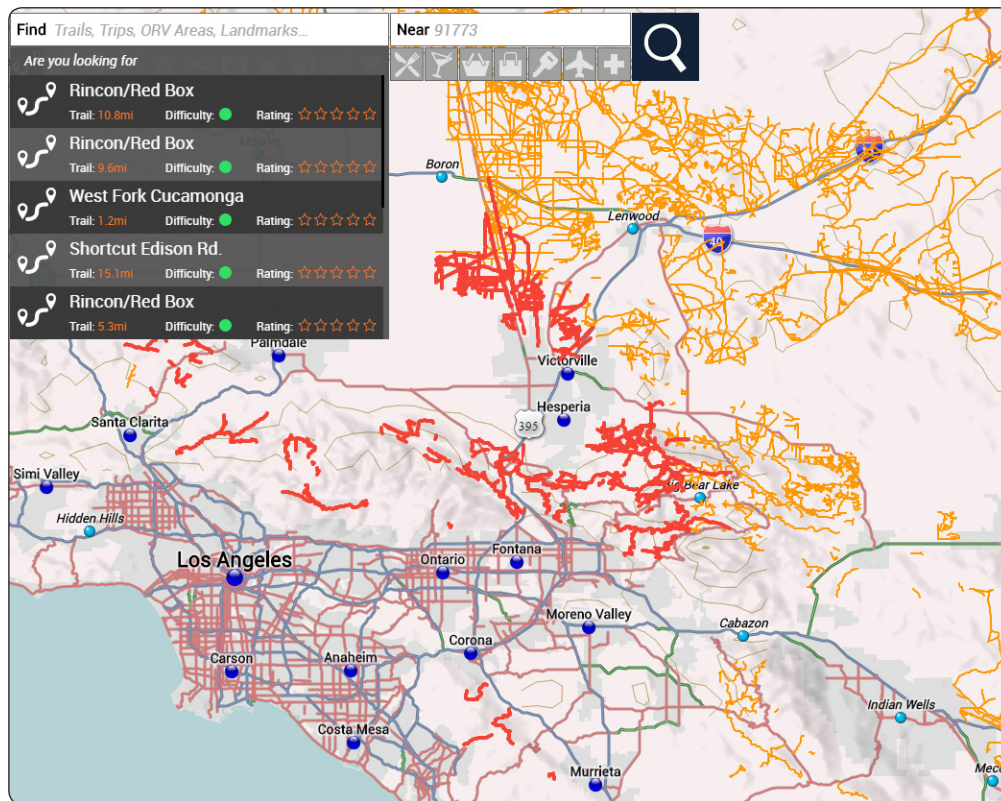

Click on a Trail or POI for information.

**Note:** Multiple Trails within a single route appear in a list form. Click any of the items in the list to view Trail information.

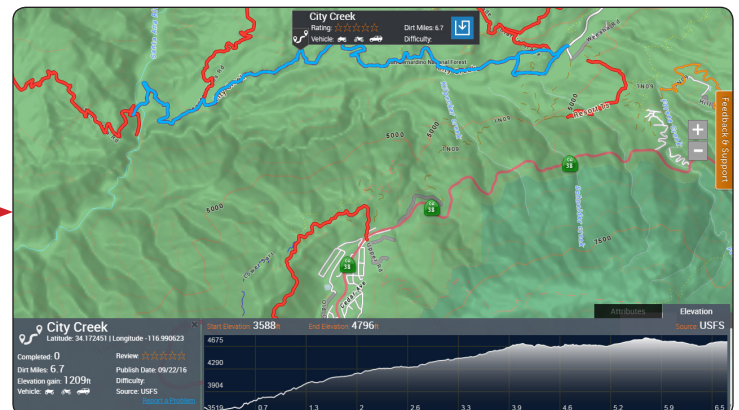
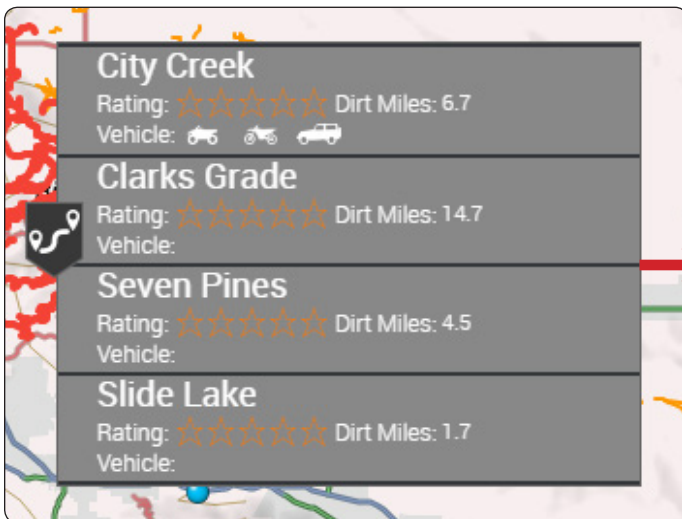

**WARNING:** Some Trails warn that **This is a publicly shared trail that has not been verified for safety. Drive at your own risk!** Review all Trail safety details before riding the Trail.

# Use TRX Trailhead.

Each Trail is represented by a Marker Label as well as Attributes and Elevation details:

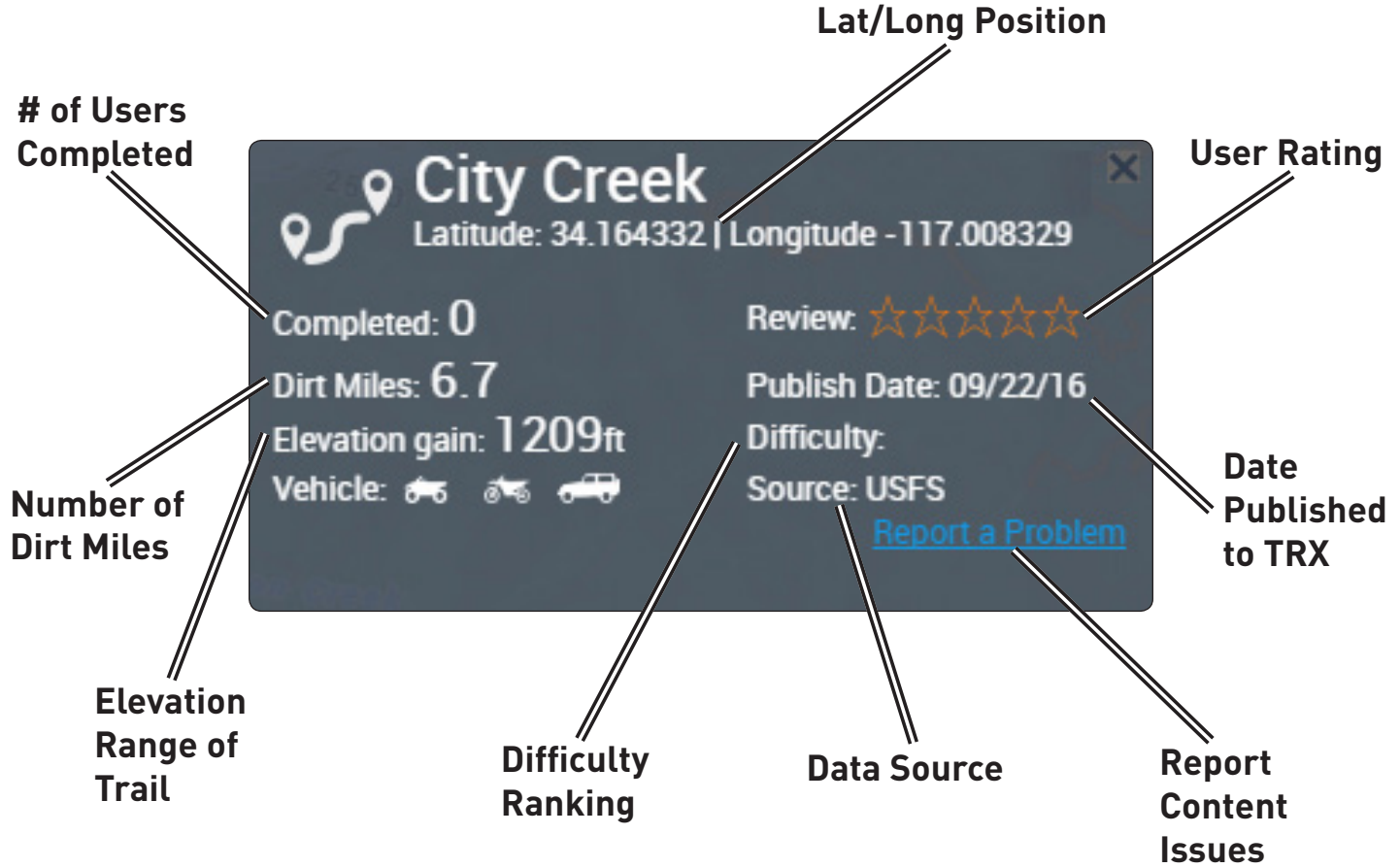
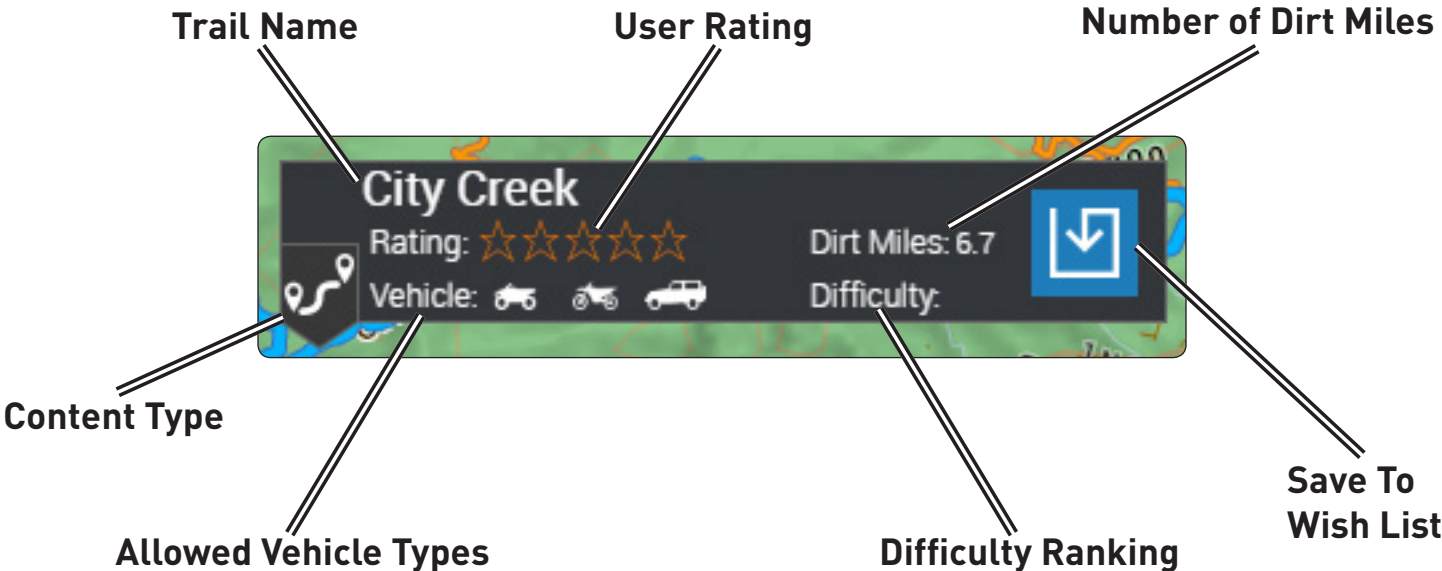



## Save To Your Wish List

Click  next to the item Marker Label to save an item from your search results to your Wish List:

**TRX** Tip: Any items you add to your Wish List on TRX Trailhead automatically sync with your TRX7 Wish List next time you sign in or if you choose **Settings > Manual Sync** from your TRX7.

## Report Issues

To report issues with an item on the map:

1. Click [Report a problem](#) on item details > check applicable boxes.

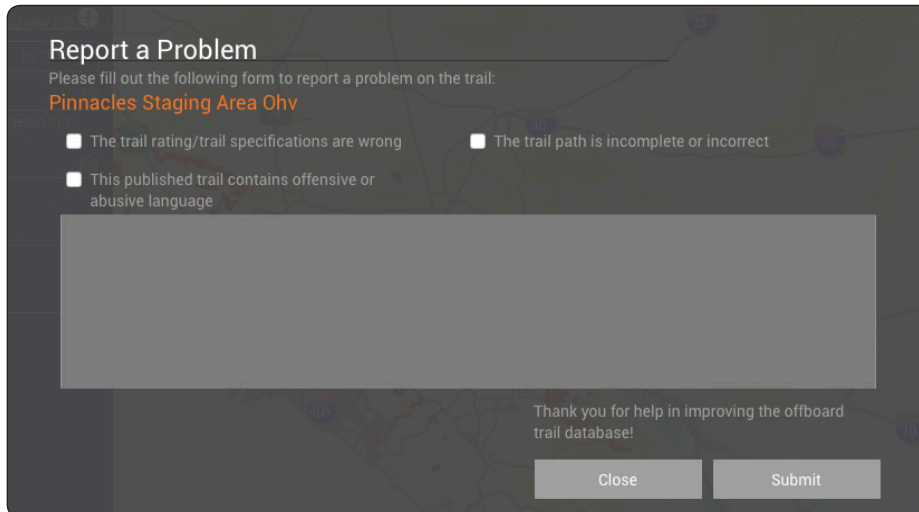

The screenshot shows a 'Report a Problem' modal window. At the top, it says 'Report a Problem' and 'Please fill out the following form to report a problem on the trail:'. Below this, the trail name 'Pinnacles Staging Area Ohv' is displayed. There are three checkboxes for reporting issues: 'The trail rating/trail specifications are wrong', 'The trail path is incomplete or incorrect', and 'This published trail contains offensive or abusive language'. A large, empty text box is provided for detailed input. At the bottom right, there is a thank you message: 'Thank you for help in improving the offboard trail database!'. Two buttons, 'Close' and 'Submit', are located at the bottom of the form.

2. Enter detailed issues in the text box.
3. Click [Submit](#) to report a problem, or [Close](#) to stop the action.

# Use TRX Trailhead.

## Create a Route.

The TRX Routing tool on [www.TRXTrailhead.com](http://www.TRXTrailhead.com) is designed to help you plan day trips, weekend trips, and even long overland voyages that you can follow using your TRX7.

With the TRX Routing tool, you can create a custom route, save it to your Wish List, and sync the route with your TRX7 Wish List.

First, create a custom route on TRX Trailhead:

1. Sign in to TRX Trailhead using your TRX account.
2. Click on the Wish List tab on the left side of the screen > click **Try TRX routing Beta**.
3. Right-click on the basemap where you want to create a Waypoint as your route starting point **OR** add an item from your Wish List as your starting point.
4. Continue right-clicking on the map along the route you wish to create to drop Waypoints along your desired route.

**NOTE:** You can also search for Trails using the TRX Trailhead search functions to assist you in creating your route.

5. Click **Route name** to enter a name for your route.
6. Click **Save** to add your custom route to your Wish List.

Once your route is saved to your Wish List, you'll see the route in your Wish List on your TRX7.

**Note:** If you don't see your new route right away, tap **Settings** > **Manual Sync** to sync your TRX7 with your TRX Trailhead data.

Now, you can follow the route using your TRX7:

1. Tap **Journal** from the TRX Dashboard > tap **Wish List**.
2. Tap on your custom route in your Wish List.
3. Tap on a routing option: **Fastest**, **Shortest**, or **Least Highways** (if desired).
4. Tap **GO** to begin routing from your current location to the route and the final destination. Routing provides visual and audible route guidance..

**Watch a video tutorial on Route Creation on the Magellan TRX YouTube channel:**



<https://www.youtube.com/watch?v=FUQeuFdVk18>

## Connect To Social Media

Connect your Twitter and Instagram accounts to your TRX Trailhead account (if you haven't already on your TRX7 device).

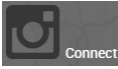
To connect to Twitter and Instagram:

1. Click **Profile** at the top right corner of the screen.
2. Click  or  to go to the Twitter or Instagram login page.
3. Enter your Twitter or Instagram login information, or create a new account for use with your TRX account.

Once you've successfully linked a social media account to your TRX account, the icon turns blue:  .

## Upload GPX Files

You can upload properly formatted GPS exchange format XML (GPX) files, with multiple Tracks or Waypoints, to your TRX Trailhead Log.

To upload a GPX file:

1. Click  **Upload GPX file** in the **Log** tab.
2. Select GPX file from your computer > open file to upload to TRX Trailhead.
3. Rate and add attributes to the file as if you're adding attributes to a Track.

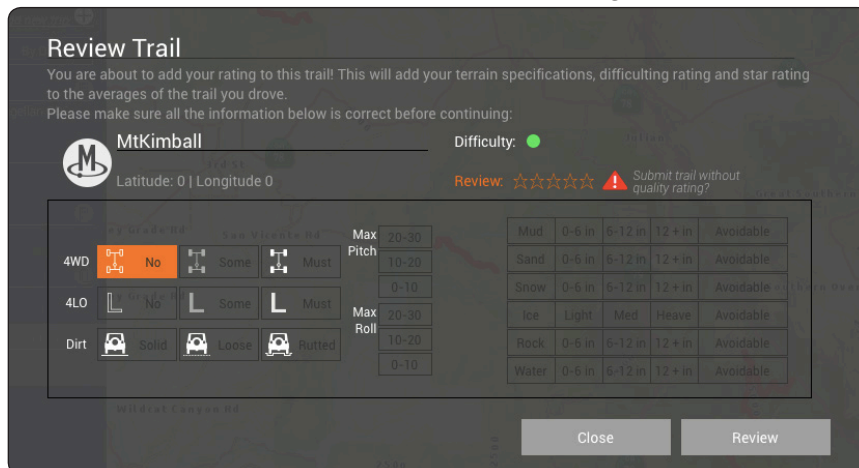

**Review Trail**

You are about to add your rating to this trail! This will add your terrain specifications, difficulting rating and star rating to the averages of the trail you drove.  
Please make sure all the information below is correct before continuing:

**MtKimball** Difficulty: ● **1** 1-5

Latitude: 0 | Longitude 0 **Review** ★★★★★ Submit trail without quality rating?

4WD	<input type="checkbox"/> No	<input type="checkbox"/> Some	<input type="checkbox"/> Must	Max Pitch	20-30	Mud	0-6 in	6-12 in	12+ in	Avoidable
					10-20	Sand	0-6 in	6-12 in	12+ in	Avoidable
					0-10	Snow	0-6 in	6-12 in	12+ in	Avoidable
4LO	<input type="checkbox"/> No	<input type="checkbox"/> Some	<input type="checkbox"/> Must	Max Roll	20-30	Ice	Light	Med	Heavy	Avoidable
					10-20	Rock	0-6 in	6-12 in	12+ in	Avoidable
					0-10	Water	0-6 in	6-12 in	12+ in	Avoidable
Dirt	<input type="checkbox"/> Solid	<input type="checkbox"/> Loose	<input type="checkbox"/> Rutted							

**Close** **Review**

4. Click **Review** to save file to your Log.

**TRX** **Tip:** Load GPX files that are 2MB or smaller for best uploading results.

# Use TRX Trailhead.

## Add a New Trip

Add a new Trip to your Log from TRX Trailhead by clicking on [Select to add new trip](#) 

To add items to your Trip:

1. Search for an item in the Basemap.
2. Click and hold on the Marker Label > drag the Marker Label to the Trip folder and release your click.

The item is added to the Trip. Repeat for each item you want in your Trip.

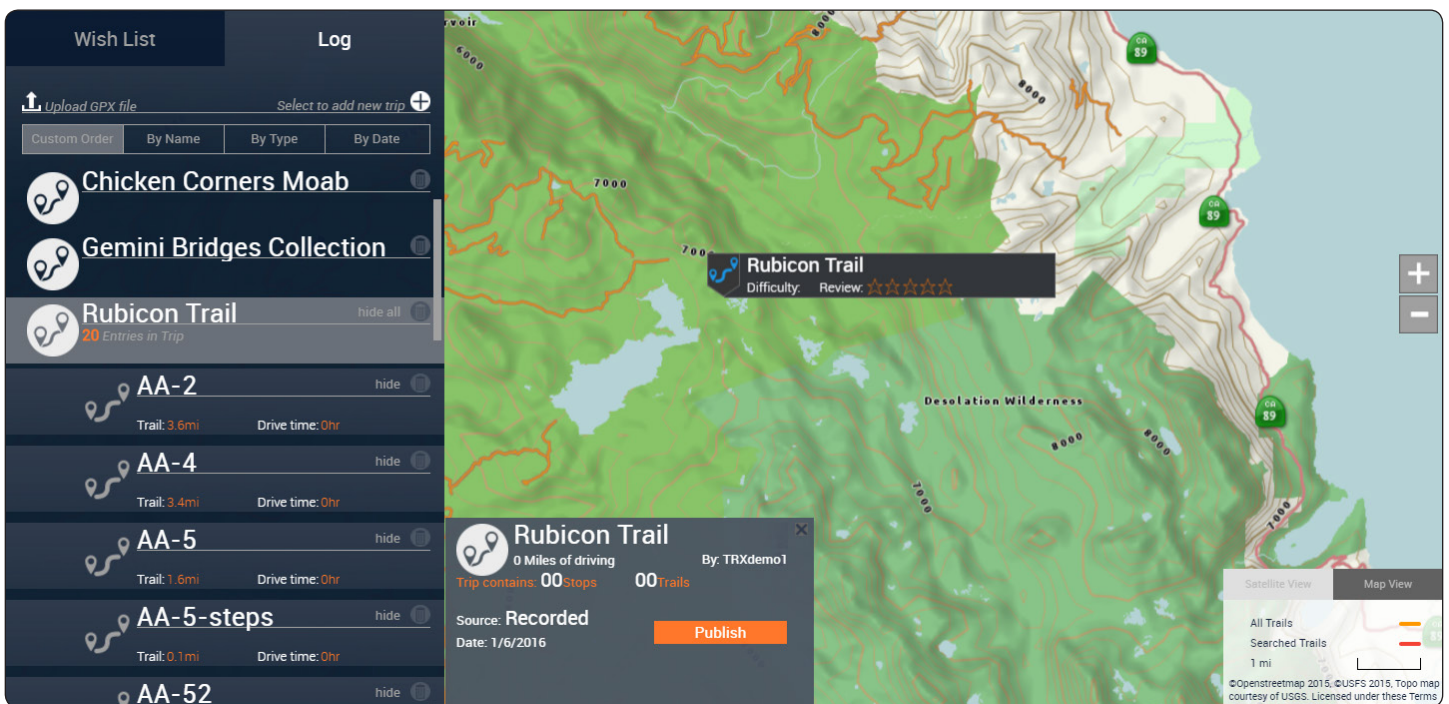

You can see the Trip in your TRX7 Log and once you've synced your account.

## TRX GLOSSARY OF KEY TERMS

Your TRX7 account syncs seamlessly with TRX Trailhead and all TRX companion mobile apps. This glossary will familiarize you with all functions associated with your TRX7 and all applications accessible with your TRX user account.

Unless otherwise noted, all interface terms are applicable to the TRX7 device and all TRX mobile apps.

**Account Profile:** overarching term for data associated with a user's account, including user name, password, saved trails/trips, social media accounts, etc.

**Achievements:** aggregate of badges earned by a user for riding a certain amount of miles, riding in specific locations, riding in specific sponsored events, etc.

**Active Track:** the real-time tracking of a user's geographic location.

**All Trails:** trails that appear orange when a user pans across the map in TRX Trailhead.

**Backtrack:** allows a user to return to the beginning of their Active Track. When selected, the user's track is highlighted, guidance arrows mark the route ahead of the user's current position, and child waypoints alert the user along the Active Track. Voice notifications alert the user at the end of the Active Track.

**Basemap:** lowest layer of the map that provides geographic context to orient users on the map.

TRX users can toggle between two basemap views:

**Map View:** shows road network, topography, selected land use areas such as forest and park boundaries, street labels, populated areas, etc.

**Satellite View:** shows aerial imagery of the earth's surface (TRX Trailhead only).

**Bearing Line Navigation:** user selects a destination waypoint. TRX displays a highlighted bearing line to the destination at all times. All Trail and Track types user has turned ON appear on the Basemap. No guidance arrows, Child Waypoint pop-ups, or audio guidance is provided, but the distance to the user's destination (as the crow flies) is displayed.

**Child Waypoint:** a waypoint recorded either during an active track, when a user attaches the waypoint to a Trip, Track, or Trail that already exists, or when a user attaches the waypoint to a Trip or Track that they are creating but not actively recording at the time.

**Detail Waypoint:** created by a user by pausing an Active Track, selecting the Detail Waypoint icon, and choosing a waypoint and associated details from the Detail Waypoint menus.

**Dirt Miles:** cumulative amount of miles logged by a user when a Track is saved to the user's account. A user can earn Achievements for driving increasing amounts of Dirt Miles.

**Elevation Profile:** interactive box showing elevation gain/loss on a trail, measured by Start and End elevations (TRX Trailhead only).

**Filter (Search):** used in Search to narrow down Trail, Trip, and POI results in the Basemap (TRX7 and TRX Apps).

**Journal:** contains a user's Log and Wish List.

**Log:** stores all of a user's recorded tracks, waypoint data, and uploaded GPX data.

**Mark Waypoint:** button that allows a user to add a Quick Waypoint (tracking in progress) or Detailed Waypoint (tracking paused).

**Marker:** icon associated with a location in the basemap indicating the type of Trail, Track, POI, etc.

**Marker Label:** text pop-up associated with a location in the basemap displaying information about the Trail, Track, or POI.

**Street Route:** a path through a road network(s).



# TRX Glossary

**Orientation:** button that allows a user to toggle between North Up and Track Up views. This button turns blue and can be tapped to restore North Up orientation when a user has panned around the map (TRX7 and TRX Apps).

**Place:** another name for a Point of Interest (POI).

**Private Files:** accessible only to their owner(s).

**Public Files:** accessible by any search by visitors to TRX Trailhead.

**Quick Waypoint:** created by a user by selecting the Quick Waypoint icon during an Active Track.

**Road network:** a set(s) of interconnected points and lines that represent possible street routes from one location to another.

**Searched Trails:** trails that appear highlighted in red when a user enters search criteria in TRX Trailhead.

**Social Post:** button available while on an Active Track that allows a user to generate an automatic Tweet to their Twitter account (TRX7 and TRX Apps).

**Syncing:** updates content and settings between TRX system components, TRX Apps, TRX devices, and TRX Trailhead to maintain consistency of content and experience across all platforms.

**Terrain Spec:** a list of conditions (4WD, 4LO, Dirt, Mud, Sand, etc.) associated with a Trail or generated by a user to describe a saved Track.

**Track:** a recorded track line saved to a TRX user's Log and which can contain waypoints saved along the Active Track.

A user's personal tracks are saved to the TRX user's Log. Downloaded user tracks are saved to the Wish List.

**Trail:** an off-highway vehicle pathway in the Basemap or other map layer that is published by a verified source that created or legally maintains responsibility for the trail.

**Trail Guidance:** a user's personal Track from their Log or Trail from their Wish List is highlighted. Guidance arrows mark the route ahead of the user's current position. Child waypoints alert the user along the track. Voice notifications alert the user at the end of the track.

**Trail Detail:** a list of coordinates, number of users driven, Drive Miles (length of trail), etc. associated with a trail.

**Trail network(s):** a set(s) of interconnected points and lines that represent possible OHV routes from one location to another.

**Trail Route:** a path through a trail network(s).

**Trip:** an user-generated file that contains one or more Tracks from the user's Log or one or more trails from the user's Wish List.

**TRX Tip:** a short blurb of information found in all TRX documentation intended to help you optimize your user experience of the TRX product family. While a **Note** provides essential information that you should take note of, a  **Tip** provides commentary that may help you find easier or more efficient ways of navigating the TRX software.

**Unguided Navigation:** all Trail and Track types that a user has turned ON are displayed on the Basemap. No highlighting, guidance arrows, Child Waypoint pop-ups, or audio guidance is provided. The Current Position marker shows user's position on the Basemap.

**Wish List:** stores all Public items that a user saves for future reference.

## Magellan Limited Warranty

All Magellan global positioning system (GPS) receivers are navigation aids, and are not intended to replace other methods of navigation. The purchaser is advised to perform careful position charting and use good judgment. READ THE USER GUIDE CAREFULLY BEFORE USING THE PRODUCT.

### 1. MAGELLAN WARRANTY

(a) MiTAC Digital Corp. ("Magellan") warrants its GPS receivers and hardware accessories to be free from defects in material and workmanship and will conform to its published specifications for the product for a period of one year from the date of original purchase. THIS WARRANTY APPLIES ONLY TO THE ORIGINAL CONSUMER PURCHASER OF THIS PRODUCT.

(b) In the event of a defect, Magellan will, at its discretion, repair or replace the hardware product with a product of like kind or quality, which may be new or reconditioned, with no charge to the purchaser for parts or labor. Magellan's limit of liability under the limited warranty shall be the actual cash value of the product at the time the purchaser returns the product to Magellan for repair less a reasonable amount for usage, as determined by Magellan in its sole discretion. The repaired or replaced product will be warranted for 90 days from the date of return shipment, or for the balance of the original warranty, whichever is longer.

(c) Magellan warrants that software products or software included in hardware products will be free from defects in the media for a period of 30 days from the date of shipment and will substantially conform to the then current user documentation provided with the software (including updates thereto). Magellan's sole obligation shall be the correction or replacement of the media or the software so that it will substantially conform to the then-current user documentation. Magellan does not warrant the software will meet purchaser's requirements or that its operation will be uninterrupted, error-free or virus-free. The purchaser assumes the entire risk of using the software.

### 2. PURCHASER'S REMEDY

PURCHASER'S EXCLUSIVE REMEDY UNDER THIS WRITTEN WARRANTY OR ANY IMPLIED WARRANTY SHALL BE LIMITED TO THE REPAIR OR REPLACEMENT, AT MAGELLAN'S OPTION, OF ANY DEFECTIVE PART OF THE RECEIVER OR ACCESSORIES WHICH ARE COVERED BY THIS WARRANTY. REPAIRS UNDER THIS WARRANTY SHALL ONLY BE MADE AT AN AUTHORIZED MAGELLAN SERVICE CENTER. ANY REPAIRS BY A SERVICE CENTER NOT AUTHORIZED BY MAGELLAN WILL VOID THIS WARRANTY.

### 3. PURCHASER'S DUTIES

For repair or replacement on a Magellan product the purchaser must obtain a Return Materials Authorization (RMA) number from Magellan Technical Support or by submitting a repair request through our website at [www.magellanGPS.com](http://www.magellanGPS.com), prior to shipping. The purchaser must return the product postpaid with a copy of the original sales receipt, purchaser's return address and the RMA number clearly printed on the outside of the package to the Authorized Magellan Service Center address provided by Magellan with the RMA number. Magellan reserves the right to refuse to provide service free-of-charge if the sales receipt is not provided or if the information contained in it is incomplete or illegible or if the serial number has been altered or removed. Magellan will not be responsible for any losses or damage to the product incurred while the product is in transit or is being shipped for repair. Insurance is recommended. Magellan recommends the use of a trackable shipping method such as UPS or FedEx when returning a product for service.

### 4. LIMITATION OF IMPLIED WARRANTIES

Except as set forth in item 1 above, all other expressed or implied warranties, including those of fitness for any particular purpose or merchantability, are hereby disclaimed AND IF APPLICABLE, IMPLIED WARRANTIES UNDER ARTICLE 35 OF THE UNITED NATIONS CONVENTION ON CONTRACTS FOR THE INTERNATIONAL SALE OF GOODS. Some national, state, or local laws do not allow limitations on implied warranty on how long an implied warranty lasts, so the above limitation may not apply to you.

### 5. EXCLUSIONS

The following are excluded from the warranty coverage:

- (a) periodic maintenance and repair or replacement of parts due to normal wear and tear;
- (b) batteries;
- (c) finishes;
- (d) installations or defects resulting from installation;

# Warranty.

(e) any damage caused by (i) shipping, misuse, abuse, negligence, tampering, moisture, liquids, proximity or exposure to heat, or improper use; (ii) disasters such as fire, flood, wind, and lightning; (iii) unauthorized attachments or modification;

(f) service performed or attempted by anyone other than an authorized Magellan Service Center;

(g) any product, components or parts not manufactured by Magellan,

(h) that the receiver will be free from any claim for infringement of any patent, trademark, copyright or other proprietary right, including trade secrets

(i) any damage due to accident, resulting from inaccurate satellite transmissions. Inaccurate transmissions can occur due to changes in the position, health or geometry of a satellite or modifications to the receiver that may be required due to any change in the GPS.

(Note: Magellan GPS receivers use GPS or GPS+GLONASS to obtain position, velocity and time information. GPS is operated by the U.S. Government and GLONASS is the Global Navigation Satellite System of the Russian Federation, which are solely responsible for the accuracy and maintenance of their systems. Certain conditions can cause inaccuracies which could require modifications to the receiver. Examples of such conditions include but are not limited to changes in the GPS or GLONASS transmission.)

The opening, dismantling or repairing of this product by anyone other than an authorized Magellan Service Center will void this warranty.

## 6. EXCLUSION OF INCIDENTAL OR CONSEQUENTIAL DAMAGES

(a) MAGELLAN SHALL NOT BE LIABLE TO PURCHASER

(b) OR ANY OTHER PERSON FOR ANY INDIRECT, INCIDENTAL OR CONSEQUENTIAL DAMAGES WHATSOEVER, INCLUDING BUT NOT LIMITED TO LOST PROFITS, DAMAGES ARISING FROM A DELAY OR LOSS OF USE, OR OUT OF THE BREACH OF THIS WARRANTY OR ANY IMPLIED WARRANTY EVEN IF CAUSED BY THE NEGLIGENCE OR ANOTHER FAULT OF MAGELLAN OR OUT OF THE NEGLIGENT USAGE OF THE PRODUCT. IN NO EVENT WILL MAGELLAN BE HELD RESPONSIBLE FOR SUCH DAMAGES, EVEN IF MAGELLAN HAS BEEN ADVISED OF THE POSSIBILITY OF SUCH DAMAGES.

(c) Some national, state, or local laws do not allow the exclusion or limitation of incidental or consequential damages, so the above limitation or exclusion may not apply to you.

## 7. COMPLETE AGREEMENT

(a) This written warranty is the complete, final and exclusive agreement between Magellan and the purchaser with respect to the quality of performance of the goods and any and all warranties and representations. THIS WARRANTY SETS FORTH ALL OF MAGELLAN'S RESPONSIBILITIES REGARDING THIS PRODUCT. THIS WARRANTY GIVES YOU SPECIFIC RIGHTS. YOU MAY HAVE OTHER RIGHTS WHICH VARY FROM LOCALITY TO LOCALITY AND CERTAIN LIMITATIONS CONTAINED IN THIS WARRANTY MAY NOT APPLY TO YOU.

(b) If any part of this limited warranty is held to be invalid or unenforceable, the remainder of the limited warranty shall nonetheless remain in full force and effect.

This limited warranty is governed by the laws of the State of California, without reference to its conflict of law provisions or the U.N. Convention on Contracts for the International Sale of Goods, and shall benefit Magellan, its successors and assigns. This warranty does not affect the consumer's statutory rights under applicable laws in force in their locality, nor the customer's rights against the dealer arising from their sales/purchase contract.

For further information concerning this limited warranty, please visit Magellan's website at [magellangps.com](http://magellangps.com) or contact:

MiTAC Digital Corp. 279 E Arrow Hwy, San Dimas, CA 91773, USA

USA & Canada: 800-707-9971

Mexico: 866-310-7223

## Need Technical Support?

To get technical support for your Magellan TRX product, go to [trxsupport.magellangps.com](http://trxsupport.magellangps.com) for troubleshooting, tutorials, and more.

If you can't find a solution there, contact Magellan Technical Support directly by e-mail at [trxsupport@magellangps.com](mailto:trxsupport@magellangps.com) or call 800-707-9971.



**eXplorist<sup>®</sup> TRX7**  
The Ultimate Off-Road GPS Navigator

[LEARN MORE](#)

**MAGELLAN**

Connect with us  
[@MagellanTRX](#)



MiTAC Digital Corporation  
279 E. Arrow Hwy, San Dimas, CA 91773 USA

[www.magellanGPS.com](http://www.magellanGPS.com)

112-0089-002

© 2017 MiTAC International Corporation. The Magellan logo and Magellan are registered trademarks of MiTAC International Corporation, and OneTouch is a trademark of MiTAC International Corporation and are used under license by MiTAC Digital Corporation. All rights reserved.  
All other trademarks and registered trademarks are property of their respective owners.