

Application de la niche sans espace technique arrière

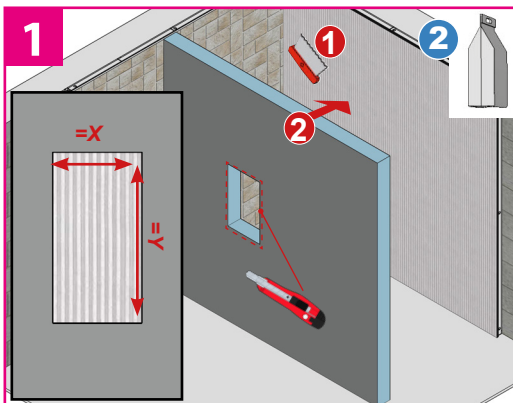

Application d'un panneau à carrelé pour compenser l'épaisseur de la niche et créer un espace technique. Découpe du panneau à la taille de la niche.

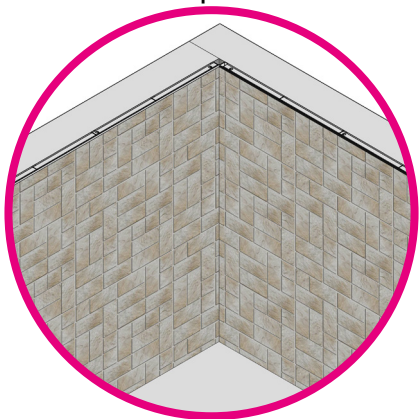
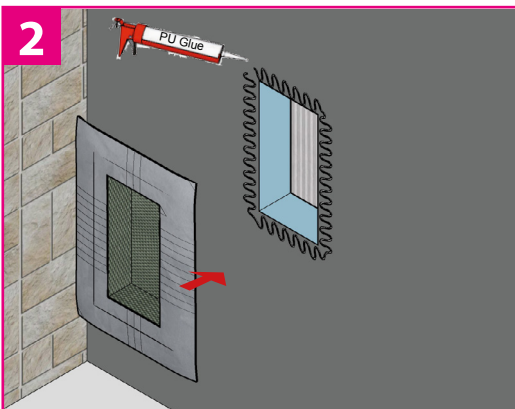

Coller la niche à l'aide de la colle PU. Bien étayer le temps que la colle sèche.

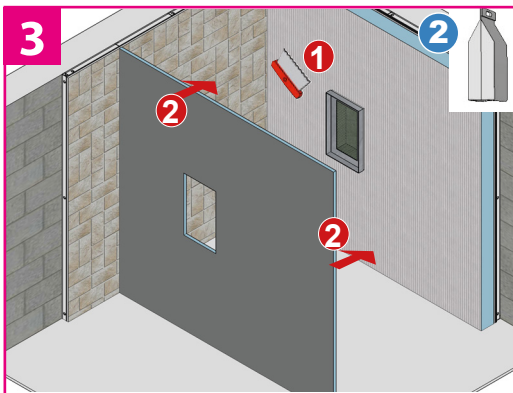

Replier la natte vers l'intérieur et compenser l'épaisseur de la platine périphérique de la niche tout autour avec un panneau à carrelé de 12,5 mm.

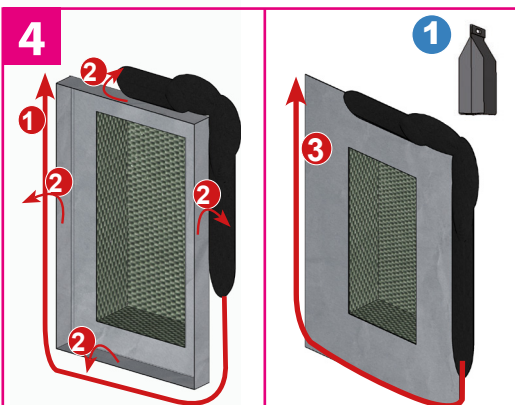

Appliquer du mortier colle sous l'emplacement de la natte. Puis maroufler la natte avec le mortier colle étanche pour étancher.

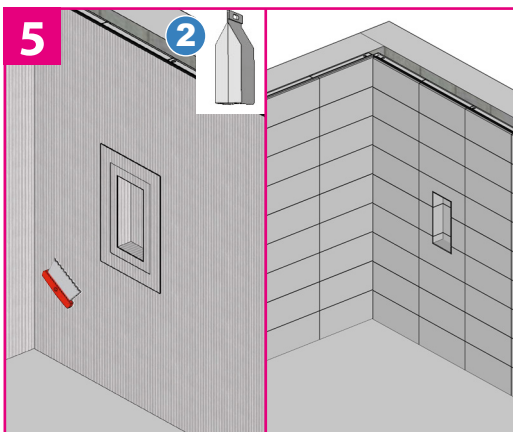

Encoller et carrelé l'ensemble.

marmox

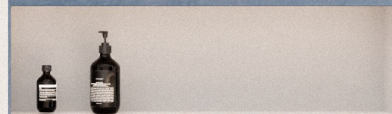

Niche

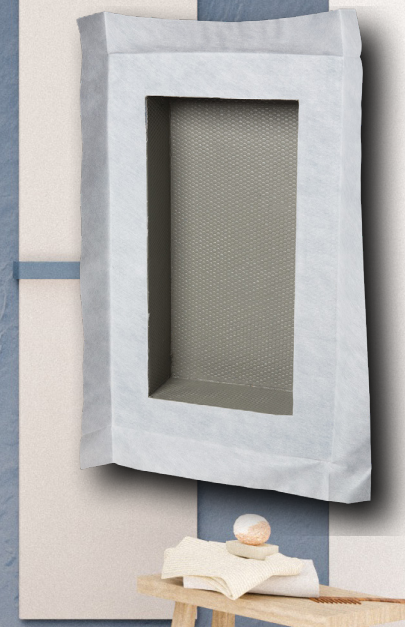

Non inclus

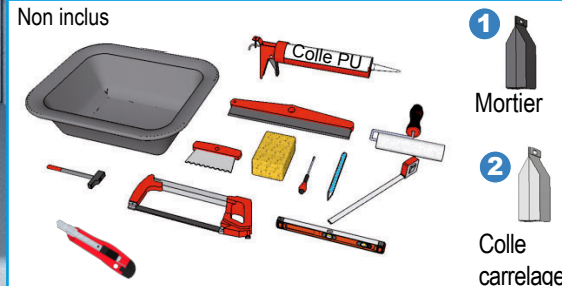

		Dimensions (en mm)									
		REF	A	B	X	Y	P	Z	C	E	F
Niche Standard	NICHE3030	400	400	300	300						
	NICHE4020	500	300	400	200						
	NICHE4030	500	400	400	300						
	NICHE4040	500	500	400	400	100	87	12,5	12,5	12,5	
	NICHE50/40-SHELF *	500	600	400	500						
	NICHE8030	900	400	800	300						
Niche faible profondeur	NICHE3030-INT	400	400	300	300						
	NICHE4020-INT	500	300	400	200						
	NICHE4030-INT	500	400	400	300	61	55	12,5	6	12,5	
	NICHE4040-INT	500	500	400	400						
	NICHE8030-INT	900	400	800	300						
Niche grande profondeur	NICHE3030-15	400	400	300	300						
	NICHE4020-15	500	300	400	200						
	NICHE4030-15	500	400	400	300	162,5	150	12,5	12,5	12,5	
	NICHE4040-15	500	500	400	400						
	NICHE8030-15	900	400	800	300						

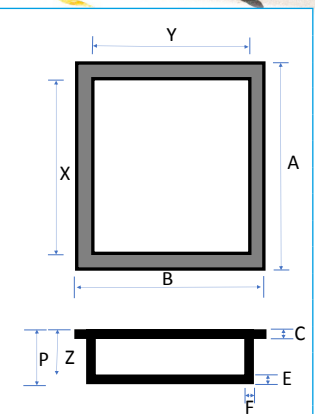

*Niche 50/40 avec étagère : Ajuster la hauteur de l'étagère avec de la colle PU et attendre 24 Heures le séchage de la colle pour carrelé.

Application de la niche sur support placo standard

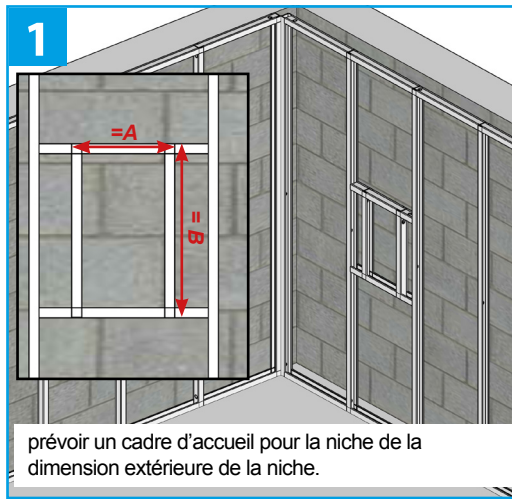
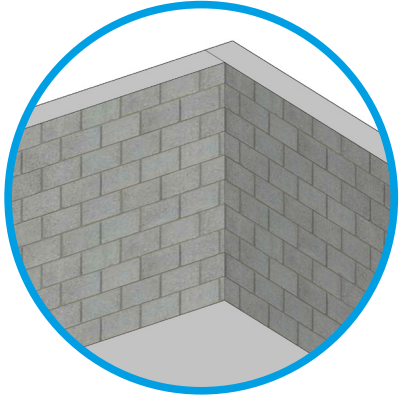

Application de la niche en rénovation sur ancien carrelage

