

# INSTRUCTION/MAINTENANCE MANUAL

---



Electric Salon Top  
Shown with optional  
Adjustable Side Arm Rests  
and Universal Table Extender

# ProLuxe™ Series



Lift Assist Salon Top  
Shown with optional  
Adjustable Side Arm Rests  
and Universal Table Extender



Lift Assist Backrest Top



Flat Top  
Shown with optional QuickLock™ Face  
Rest and Boiance crescent

made in the USA  
with US & imported parts

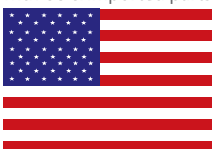

[www.oakworks.com](http://www.oakworks.com) · 717.235.6807

**OAKWORKS®**

© Copyright 2012  
OAKWORKS®, Inc.

All rights are reserved. No part of this document may be photocopied, reproduced or translated to another language without prior written consent of OAKWORKS®, Inc.

OAKWORKS® is a registered trademark of OAKWORKS®, Inc.

#### Notice

The information contained in this document is subject to change without notice and should not be construed as a commitment by OAKWORKS®, Inc.

OAKWORKS®, Inc. assumes no responsibility for any errors that may appear in this document nor does it make expressed or implied warranty of any kind with regard to this material, including, but not limited to, the implied warranties of merchantability and fitness for a particular purpose.

OAKWORKS®, Inc. shall not be liable for incidental or consequential damages in connection with or arising out of the furnishing, performance, or use of this document and the program material which it describes.

TABLE OF CONTENTS

- Symbol Identification** .....1
- Introduction** .....1
- Warnings & Safety Instructions** .....2
- Section I: Product Descriptions & Photos**

  - ProLuxe™ Flat Top .....3
  - ProLuxe™ Lift Assist Backrest Top .....4
  - ProLuxe™ Lift Assist Salon Top .....5
  - ProLuxe™ Electric Salon Top .....6

- Section II: Installation**

  - Grounding .....7

- Section III: Directions for Use**

  - Control Operation .....8-9
  - Important Safety Note .....9
  - Manual Top Operation .....10
  - Moving The Table .....11
  - Optional Dual Locking Casters .....11
  - Optional QuickLock Face Rest .....12
  - Optional Hot Towel Cabi Shelf & Storage Shelf .....12
  - Optional Table Extender .....12
  - Optional Adjustable Side Arm Rests .....13

- Section IV: Troubleshooting**

  - If the Table Will Not Change Position .....14

- Section V: Maintenance & Service**

  - Cleaning .....15
  - Inspection & Maintenance .....15
  - Warranty Information .....16
  - List of Parts .....16
  - Model Number & Serial Number Location .....17
  - Model Number Chart .....17
  - Specifications .....18
  - Guidance and manufacturer’s declaration -  
Electromagnetic emissions .....19
  - Recommended separation distances .....19
  - Guidance and manufacturers declaration -  
Electromagnetic immunity .....20-21
  - Contact Information ..... Back Cover

**SYMBOL IDENTIFICATION**



This symbol, when used in this manual and on product labels, represents a caution warning. Be sure to read and comply with all precautions and warnings.



This symbol, when used in this manual and on product labels, warns against an electrical shock hazard. Be sure to observe and comply with all warnings.



This symbol, when used in this manual or on product labels, indicates a Protective Earth (Ground) Terminal.



This symbol, when used in this manual or on product labels, indicates the date of manufacture of the device.



This symbol, when used in this manual or on product labels, indicates alternating current (AC).



This symbol, when used in this manual or on product labels, indicates direct current (DC).



This symbol is used to indicate that the operator should consult the user manual.

**INTRODUCTION**

Oakworks ProLuxe Series offers a variety of positioning capabilities for massage therapists and spa professionals of all specialties. On these multifunctional professional tables the practitioner can perform numerous protocols with ease and comfort. The fully electric ProLuxe Series is especially effective when professional protocols require specific positioning for the client or patient. While the client receives comfortable, relaxing support, the comfort level of the therapeutic professional is enhanced by superior ergonomics.

It is intended to be operated by Massage Therapists in a professional environment. No special training is required but a review of the following Safety Instructions is important for the safety of the operator and patient. The massage professional should read and understand this entire manual before use with a client. There are no known contraindications to the use of this equipment.

The ProLuxe Series should not be used in any other manner than that described within this manual. Use of any unnecessary force or unauthorized procedures could result in injury to practitioner, client or equipment.

**READ AND  
SAVE THESE  
INSTRUCTIONS**



**CAUTION**

**IMPORTANT SAFETY INSTRUCTIONS**

The use of accessories, transducers, and cables other than those specified by the manufacturer, may result in increased emissions or decreased immunity of the Exam Table.

The Exam Table should not be used adjacent to or stacked with other equipment and that if adjacent or stacked use is necessary, the Exam Table should be observed to verify normal operation in the configuration in which it will be used.

The Exam Table is designed to be a stand-alone table. This table must not be modified or incorporated into any other equipment.

As with any moving mechanism there are potential pinch points around and underneath the table. It is the responsibility of the operator of this equipment to insure that bystanders are not in the area below or around this equipment during operation.

Proper operation of this equipment is very important for the safety of the operator, patient, and any other individuals in the area of this equipment. Directions for use of this equipment are described on pages 10 through 17. The operator should read these sections carefully.

Weight Limit: (patient and accessories) 550 lbs. (250 kg) Do not exceed.

Be certain that the table is completely lowered without any tilt being present prior to discharging an ambulatory patient. The patient may lose balance and fall.

This table is not suitable for use in the presence of flammable anesthetic mixture with air or oxygen or nitrous oxide.

Do not operate where aerosol (spray) products are being used or where oxygen is being administered.

Do not lift table by the table top. This can damage the table.

When lowering the table, make sure there is nothing underneath the table top that can impede motion (like stools, cabinets, accessory parts, cleaners, etc)

Use this furnishing only for its intended use as described in these instructions. Do not use attachments not recommended by the manufacturer.

Close supervision is necessary when this furnishing is used by, or near children, invalids, or disabled persons.



**WARNING**

To reduce the risk of burns, fire, electric shock or injury to persons:

1. Unplug this furnishing from the electrical outlet before cleaning.
2. Unplug from outlet before adding or removing parts.
3. Never operate this furnishing if it has a damaged cord or plug, if it is not working properly, if it has been dropped or damaged, or dropped into water. Contact Oakworks Customer Service before use at 717.235.6807.
4. Keep the cord away from heated surfaces.
5. Never drop or insert any object into any opening.
6. Do not use outdoors.



**DANGER**

Risk of electric shock - Connect this furnishing to a properly grounded outlet only. See Grounding Instructions on page 9.

Electrical Shock Hazard. The power supply/control module is located on the lift frame. No user serviceable parts are inside. Refer servicing to qualified personnel. Unplug wall plug prior to contact with any cables connected to the power supply.

## PROLUXE - FLAT TOP

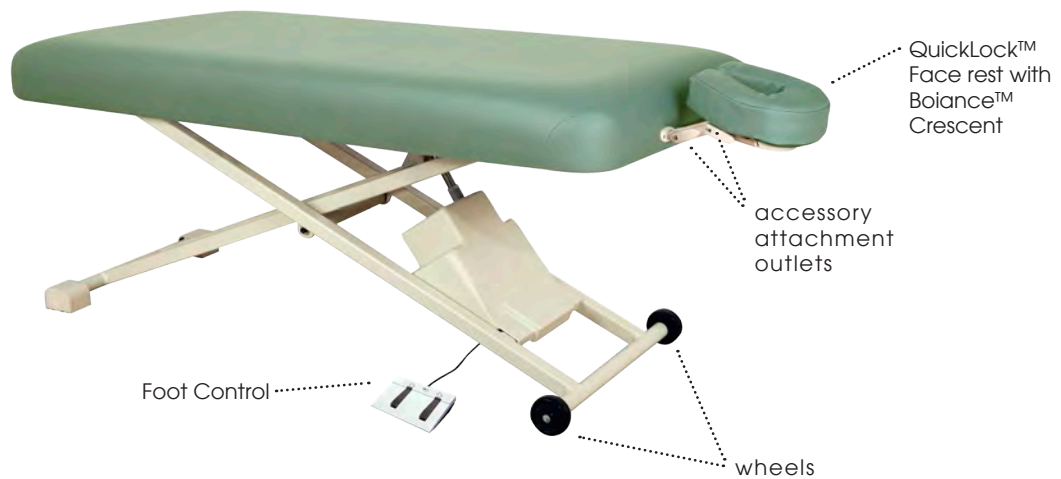

## TABLE SPECIFICATIONS

- Height: 18" - 35"
- Weight: 175 lbs.
- Width: 29", 31"
- Length: 73"
- Lift Capacity: 550 lbs.
- Top: Flat Top
- Padding: Plush, 4" AeroCel, 6" AeroCel
- Upholstery: TerraTouch
- Electronics: Single motor,  
1 low voltage foot control
- Safety listings: cETLus, CE marked

For electrical specs, see Specifications Chart in the back of this manual.

- published weight may differ due to options chosen, natural material variations and padding density

## PROLUXE - LIFT ASSIST BACKREST TOP



### TABLE SPECIFICATIONS

- Height: 21" - 38"
- Weight: 175 lbs.
- Width: 29", 31"
- Length: 73"
- Lift Capacity: 550 lbs.
- Top: Lift Assist Backrest Top
- Padding: Plush, 4" AeroCel, 6" AeroCel
- Upholstery: TerraTouch
- Electronics: Single motor,  
1 low voltage foot control
- Safety listings: cETLus, CE marked

For electrical specs, see Specifications Chart in the back of this manual.

- published weight may differ due to options chosen, natural material variations and padding density

**PROLUXE - LIFT ASSIST SALON TOP**



**TABLE SPECIFICATIONS**

- Height: 21" - 38"
- Weight: 175 lbs.
- Width: 29", 31"
- Length: 73"
- Lift Capacity: 550 lbs.
- Top: Lift Assist Salon Top
- Padding: Plush, 4" AeroCel, 6" AeroCel
- Upholstery: TerraTouch
- Electronics: Single motor, 1 low voltage foot control
- Safety listings: cETLus, CE marked

For electrical specs, see Specifications Chart in the back of this manual.

- published weight may differ due to options chosen, natural material variations and padding density



## PROLUXE - ELECTRIC SALON TOP



## TABLE SPECIFICATIONS

- Height: 21" - 38"
- Weight: 175 lbs.
- Width: 29", 31"
- Length: 73"
- Lift Capacity: 550 lbs.
- Top: Electric Salon Top
- Padding: Plush, 4" AeroCel, 6" AeroCel
- Upholstery: TerraTouch
- Electronics: Three motors, 1 low voltage foot control
- Safety listings: cETLus, CE marked

For electrical specs, see Specifications Chart in the back of this manual.

- published weight may differ due to options chosen, natural material variations and padding density

The tables come completely assembled and ready to use. Plug the cord into a functioning outlet that is rated for the table.

Arrange the power cord and control cords so that they will not create a tripping hazard and where the controls are located to your liking and are conveniently accessible.

To disconnect the table from electrical power, remove the plug from the outlet. Be sure access to plug is not blocked for disconnecting the table from power.

## GROUNDING



### WARNING



Be sure to read all cautions, warnings and instructions given in the manual to prevent injury to both operator and client.

This product must be grounded. If it should malfunction or break down, grounding provides a path of least resistance for electrical current to reduce the risk of electric shock. This product is equipped with a cord having an equipment-grounding conductor and a grounding plug. The plug must be plugged into an appropriate outlet that is properly installed and grounded in accordance with all local codes and ordinances. See U.S. sample below.

This product is manufactured for use on a nominal 120-volt circuit for the United States and a nominal 220-volt circuit for use in Europe. The plug has a grounding pin (see figure A) in a pattern that varies by country as shown in the Product Identification section of this manual. Make sure that the product is connected to an outlet having the same configuration as the plug.

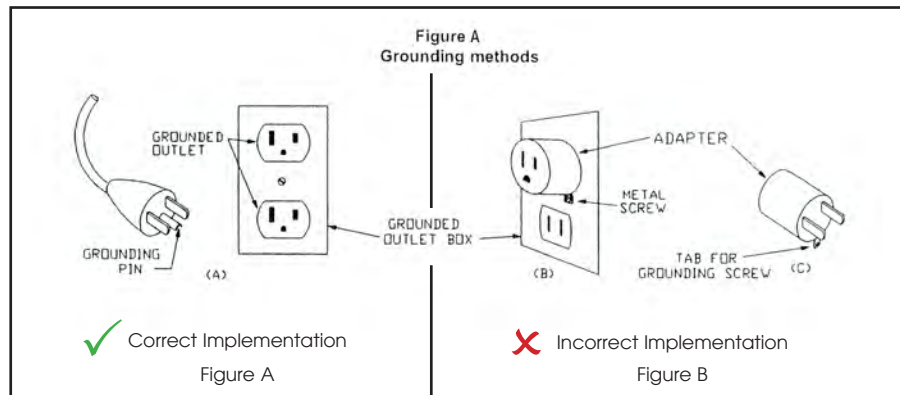

**DANGER**-Improper connection of the equipment-grounding conductor (see figure B) can result in a risk of electric shock. Check with a qualified electrician or service man if you are in doubt as to whether the product is properly grounded. Do not modify the plug provided with the product - if it will not fit the outlet, have a proper outlet installed by a qualified electrician.

To reduce the risk of electric shock, this furnishing has a polarized plug. This plug will fit in a polarized outlet only one way. Do not change the plug in any way.

## ELECTRIC TABLE ADJUSTMENTS (FLAT, GAS ASSIST BACKREST & GAS ASSIST SALON TOPS)

Foot Control: used to change height



### CAUTION

When operating the controls and making any and all adjustments to the table, move hands and feet away from the working mechanism of the table.

Children must be supervised when around this equipment by a responsible adult.

When operating the controls be sure to observe all cautions and warnings given in the manual to prevent injury to both operator and client.

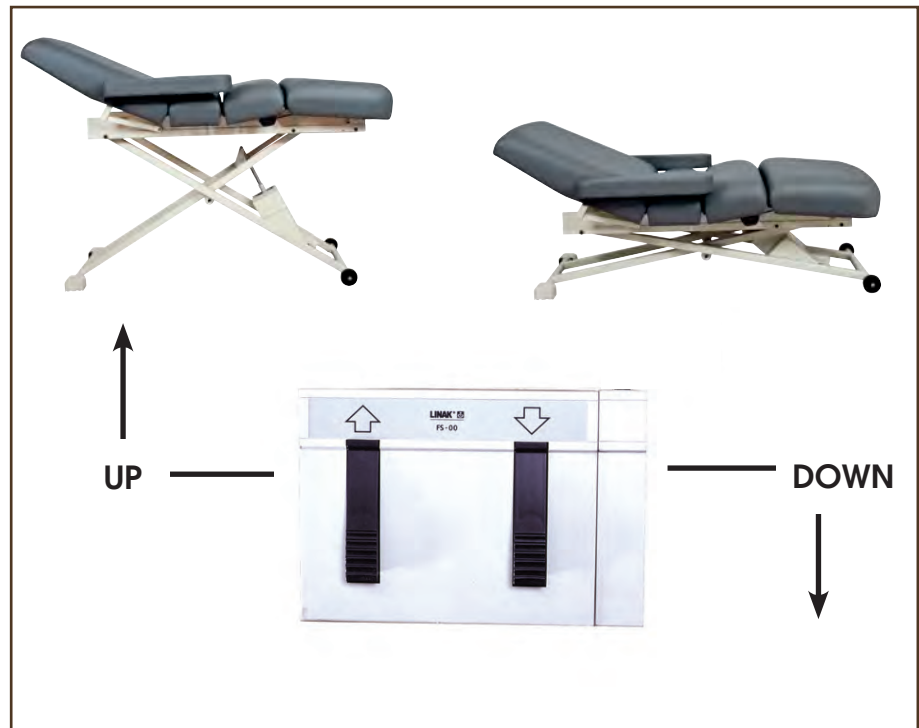

### ELECTRIC TABLE ADJUSTMENTS (ELECTRIC SALON TOP)

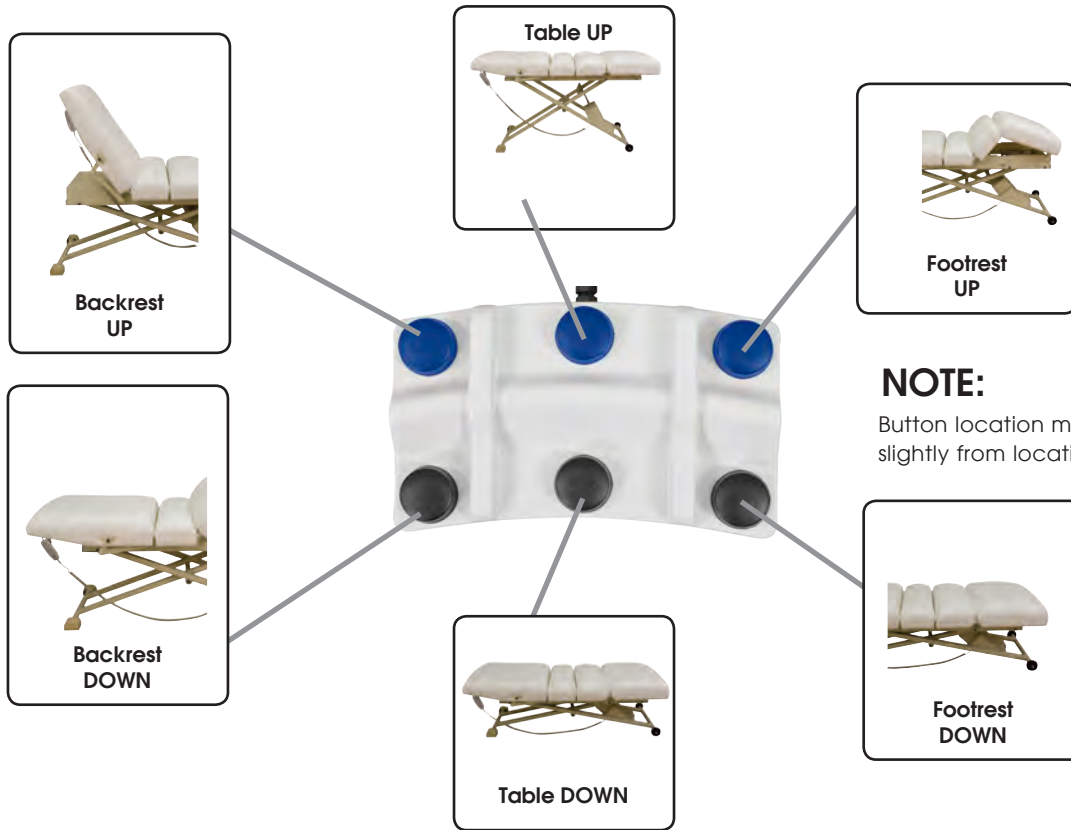

**NOTE:**

Button location may vary slightly from locations shown

### IMPORTANT SAFETY NOTE

The hood area under the backrest top is not designed for storage or as an area to hold accessories while with a client. **DO NOT** use this area for holding anything. Damage can occur to the table, especially when commands that are accessed by the foot control are activated. Placing anything on this area will prohibit movement of the backrest and can cause damage to the table or the object and will void the warranty.

**NOT FOR STORAGE!**



## OPERATING THE MANUAL TOP (GAS ASSIST BACKREST & GAS ASSIST SALON TOPS)

### BACK REST



#### To Raise the Back Rest:

Raise the back rest by pressing the lever under the head section and lifting up to the desired height. It is recommended that the client take some weight off the back rest while you lift.

#### To Lower the Back Rest:

Press the lever under the head section and push the back rest down. Release the lever and the back rest will stay in place.

#### To Change Position of the Back Rest Lever:

The back rest lever can be moved to the opposite side of the back rest by removing the screws and relocating the hand lever to the opposite side of the top into the four pre-drilled holes.

### LEG REST

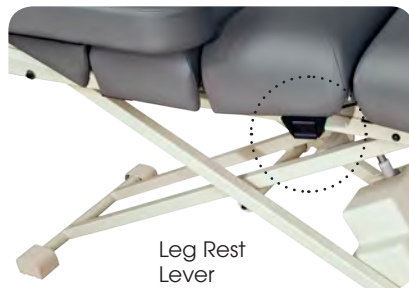

#### To Raise the Leg Rest:

Raise the leg rest by pulling the lever on the side of the leg section and raise to the desired height. It is recommended that the client take some weight off the leg rest while you lift.

#### To Lower the Leg Rest:

Pull the lever on the side of the leg section and push the leg section down. Release the lever once leg rest is at desired location and the leg section will stay in place.

#### To Change Position of the Leg Rest Lever:

The leg rest lever can be moved to the opposite side of the table. First, remove the screws from the lever and replace just the screws. Move lever to the opposite side of the table. Remove the screws that are there and install the lever.

## WARNING



Before moving any of the Tables, disconnect the power cord from the power outlet.

## CAUTION



The table weighs as much as 175 lbs. Use extreme caution when lifting the table to move it. Two people are needed to move the table safely. Be sure to bend from the knees to prevent back strain and possible injury.

DO NOT move the table with client still on the table.

## IMPORTANT

Be sure to grasp the frame at the brace between the two legs of the frame on the end with the self-locking molded rubber feet to allow the wheels to move.

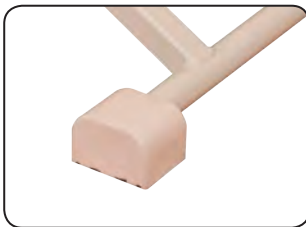

## MOVING THE TABLE

The table is equipped with two wheels at one end and two self-locking, molded rubber feet at the other. When ready to move the table, first lower the table to its lowest position. On models with a backrest, it is recommended to raise the back rest to a high position. Then be sure the power source is disconnected. Place the cord out of the way on top of your table before moving the table.

Pick up all controls and lay them on the center of the table. Lay a towel or a cloth down on your table top to protect the surface from any debris from the bottom of your foot controls.

Two people are needed to safely move the table. Grasp the table at the brace between the molded rubber feet at that end of the table. By grasping the table frame firmly at this point, you can raise the table to allow the wheels at the foot end to move freely. Use proper positioning when raising the table by bending at the knees before lifting. This prevents back strain or possible injury.

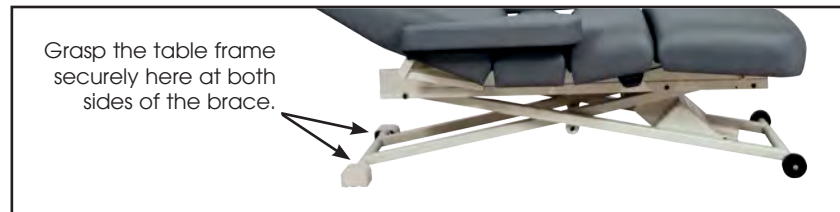

Move the table carefully to the next location, lower the table and release. Check the self-locking molded rubber feet to be sure they are flat side down. This position “locks” the table and allows sturdy height adjustments. Place the foot controls in position on the floor. Connect the power cord to the outlet and test the foot controls.

## OPTIONAL DUAL CASTERS

A more convenient way to move the table from room to room (without a patient) is with the dual caster option. Unlock the four casters and maneuver the table to your desired location. The table can be pushed from either end. Make sure to lock at least one caster from each side prior to use by a patient. The Dual Caster option was designed to enable small table positioning with the patient still on the table, but do not attempt to move the patient from room to room while on the table.

unlocked



locked



### QUICKLOCK™ FACE REST:



#### CAUTION:

Do Not extend the dowels of the Face Rest further than 3" from the table edge to ensure a stable connection.

Do not put excessive weight or pressure on the face rest. Excessive pressure can cause premature failure of the QuickLock™ Face Rest.

Be sure to use either the face rest or head rest for all treatments that require your client to lay flat. Double articulating action provides nearly limitless positioning options with the QuickLock™ Face Rest. The adjustable pad takes pressure off sensitive facial areas while providing superb support. The QuickLock™ Face Rest can be used in both prone and supine positioning and folds out of the way when not in use. Adjustments are made easily by loosening the cam locks, adjusting for height and angle and then locking the cam locks into that position.

Attaching the QuickLock™ Face Rest: \* U.S. Patent #5,177,823

When attaching the QuickLock™ Face Rest, just slide the frame dowels into the holes in the head rest end of the table. Be sure to keep the 1st cam lock within 3" of the table to ensure a stable connection. To remove the QuickLock™ Face Rest, just pull the frame from the table until it comes free. Set it safely aside.



### HOT TOWEL CABI SHELF & STORAGE SHELF



#### CAUTION:

The Anti-Tip Strap must be installed when using a Hot Towel Cabi.

Do not overload the storage shelf. (Max load weight is 25 lbs. (11.3 kg))

The Cabi Shelf holds a Hot Towel Cabi with dimensions no greater than 17.9" wide x 12.6" deep x 11.4" high. Place the Hot Towel Cabi on the Cabi Shelf and center it. Wrap the Anti-Tip Strap tightly around the Cabi and shelf as shown to secure it against tipping.

The Power Strip will power the Hot Towel Cabi and other devices. Make sure all cords are safely located out of the way to avoid trip hazards. Make sure that no cords are pinched when the table is raised or lowered.

The Storage Shelf provides storage for items needed during treatments and extra equipment.



### ATTACHING THE TABLE EXTENDER

The optional Table Extender provides ultimate comfort for your tallest clients, quickly and easily. The Table Extender comes with two connecting arms that slide into the outlets at the foot end of the table top. Slide those fully into the outlets so the Table Extender is flush to the end of the table top.



## ARM REST INSTALLATION AND ADJUSTMENT INSTRUCTIONS

### OPTIONAL ACCESSORY AVAILABLE ON 4 SECTION TOP ONLY

**CAUTION:** Do not use the arm rest for customer weight support during the mounting or dismounting of the table. The arm rest is not designed to support the patient's weight.



Adjustable Side Arm Rests



Manicure Arm Rests

### TO INSTALL THE ARM REST:

The arm rests adjust automatically as the table's back support moves to remain parallel to the floor in any position. They are designed to be strong and will take a reasonable amount of weight, but they are not designed to be used to sustain a person's weight when getting on or off the table.



1. Insert end of arm rest into hole in backrest while holding arm rest at 60° angle.



2. Push end all the way into hole and drop arm rest into horizontal position. Tug slightly to make sure the armrest is fully locked to the table (for patient safety).

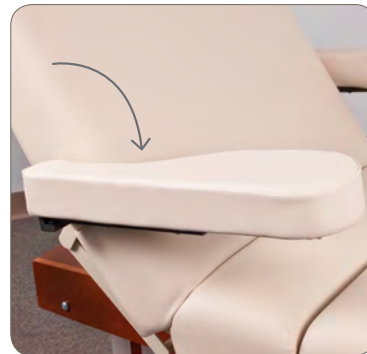

To remove the arm rest, simply reverse the procedure above.

### TO LEVEL THE ARM REST:

The arm rest height is adjusted to level at the factory. When in use, some of the new parts will wear, and you may see some sagging of the arm rest over time. If the arm rest is too low the height can easily be adjusted using the enclosed Allen wrench.



To Raise the Arm Rest



1. Loosen bottom 2 set screws (turn counter-clockwise).

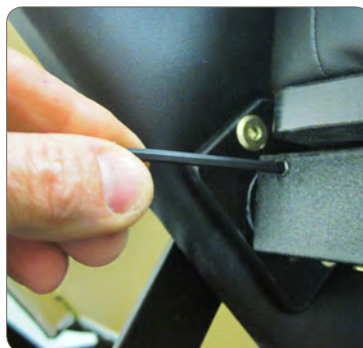

2. Turn side set screw (clockwise to raise or counter clockwise to lower) while lightly raising the arm rest with your other hand (to make the adjustment easier).



3. When you have achieved the desired height, tighten the two bottom set screws (turn clockwise).



**IF THE TABLE WILL NOT CHANGE POSITION****CAUTION**

The table weighs as much as 175 lbs. DO NOT lift or move the unit without using proper safety procedures or equipment. DO NOT turn the table on its side for any reason. To do so could cause damage to the base and will void the warranty. There are no serviceable items that need this action.

If the table will not change position:

- Check the outlet to be sure that it has power and that the power cable is plugged in. Try the foot control buttons to see if any work. If any of the buttons work, then possibly there is a loose connection or a faulty controller.
- Unplug the power cable from the wall outlet.
- Make sure that all male and female connectors are firmly pushed into each other. Even a slight misconnection can cause a possible malfunction.
- Plug the unit back into the wall and check the controls again. If none work, then contact Oakworks customer service at 717.235.6807

Questions to ask before calling Customer Service:

- Is the unit plugged in?
- Does the outlet have power?
- Are all connections of the control box seated securely?
- Does the table move with any foot control button?
- Is the control box green light on?

Oakworks tables are designed and built to provide many years of dependable service. Please follow local regulations and laws when disposing of the electrical components used in this table.

## CLEANING

**CLEAN** your upholstered items when needed using a mild solution of 4:1 diluted non-alcohol cleaner such as Formula 409®, Fantastik®, or Green Windex®

**DISINFECT** your fabric with Protex, MadaCide, MadaWipe, Accell TB, Virox® (Canada), or a diluted 1/10 bleach solution. Dry immediately after cleaning to remove excess cleaning solution.

**DO NOT** use citrus based cleaners or other strong cleaners, such as alcohol, acetone, higher concentrations of bleach or other products that contain high concentrations of these substances.

**DO NOT** expose the fabric to temperatures below 32°F/0°C or above 95°F/35°C.

**DO NOT** expose the fabric to direct sunlight, adhesives, liquids, or abrasive materials.

**FAILURE TO FOLLOW RECOMMENDATIONS WILL VOID THE WARRANTY ON THE FABRIC.**

### IMPORTANT



## CAUTION

Before cleaning with any liquid cleaner be sure to unplug the power cord from the power outlet.

### IMPORTANT

## INSPECTIONS & MAINTENANCE

RECOMMENDED REGULAR INSPECTIONS (monthly or local standard)

- Check for damage to the power, handset or foot switch cables.
- Visually inspect components for obvious damage that could cause problems during operation.

RECOMMENDED PERIODIC INSPECTIONS (yearly or local standard)

- Check for damage to the power, handset or foot switch cables and all visible wiring.
- Visually inspect components for obvious damage that could cause problems during operation.
- Check all mechanical functions using the foot control. Repeat using the hand control. Check for abnormal noises.
- Replace any missing or illegible labels.
- Check that all fasteners are present and fastened securely.
- Check table grounding.
- Clean unusual buildup of dirt on the table and/or parts of the table not normally cleaned on a regular basis.
- Check for tears or cracks in the tabletop pads.

MAINTENANCE

- No specific maintenance tasks are required.
- Oakworks medical tables are designed and built to provide many years of dependable service. Please follow local regulations and laws when disposing of the electrical components used in this table.

**WARRANTY**

For full warranty details, please visit [www.oakworks.com](http://www.oakworks.com)

All warranties are limited to factory-provided replacement parts, factory repair or replacement, at the discretion of OAKWORKS®.

All warranties exclude damage caused by improper set-up, accident, abuse, misuse, neglect, use for other than intended purpose or reasonable wear such as tears in the upholstery.

All warranties are invalidated by non-factory modifications and unauthorized repairs, which will immediately terminate all liability by OAKWORKS® for the product or damages caused by its use.

The buyer and its customers shall be responsible for proper set-up and use of the products as well as any supervision required for safety. In no event shall OAKWORKS® be liable for any special, indirect, consequential, incidental, exemplary or punitive damages or costs. Use of non-approved cleaning solutions voids the guarantee on all fabrics.

The warranties set forth herein are the sole and exclusive warranties provided by OAKWORKS®. There are no other warranties, representations or guarantees provided by OAKWORKS® either expressed or implied, including warranties of merchantability and fitness for a particular purpose.

Warranty valid with proof of purchase.

**PART NUMBERS**

**PART NUMBER.....DESCRIPTION**

4025.....	Actuator (1)
TBD.....	Foot control with cord
4046-1 .....	120 Volt Control Module/North America
4026-2 .....	220 Volt Control Module/Swiss-Europe-United Kingdom
4026-3 .....	100 Volt Control Module/Japan-Korea
5097-1 .....	Power Cord/North America
5097-2 .....	Power Cord/United Kingdom
5097-3 .....	Power Cord/Europe
5097-4 .....	Power Cord/Swiss

**MODEL NUMBER & SERIAL NUMBER LOCATION**



The model number and serial number are located on the underside of the foot section.

**PX Series, ProLuxe™ & Physical Therapy Tables**

Model Number
Serial Number

16796025 PXSLFT311873ACTTVN Ser#: PXR563146  
 US G2 30 x 22-38 x 72 3M/TT/2S  
 TTSKYBLUE 01/04/2013 Order#:654321  
 Notes: Sample Product Label

**Intertek**  
 3034177  
 CONFORMS TO:  
 ANSI/ISO 9001-1:2008  
 IEC 60601-1-6  
 Certified to CAN/CSA STD  
 C22.2 No. 60601-1-1

**CE**  
 European Authorized  
 Representative:  
 Emergo Europe  
 Molenstraat 15  
 The Hague, 2513 BH  
 Netherlands

Power Rating: US 120 V 60 Hz 2.7 A  
 Duty Cycle: MAX 2 minutes ON/18 minutes OFF  
 Class 1 Equipment

923 East Wellspring Rd.,  
 New Freedom, PA 17349 USA  
 Phone: 717-235-6807  
 www.oakworks.com

made in the USA  
  
 Part No. 70537-9 rev. B

Model Numbers and Serial Numbers always start with a letter.

**MODEL NUMBER CHART**

**PX SL FT XX XX XX AC TT VN F6**

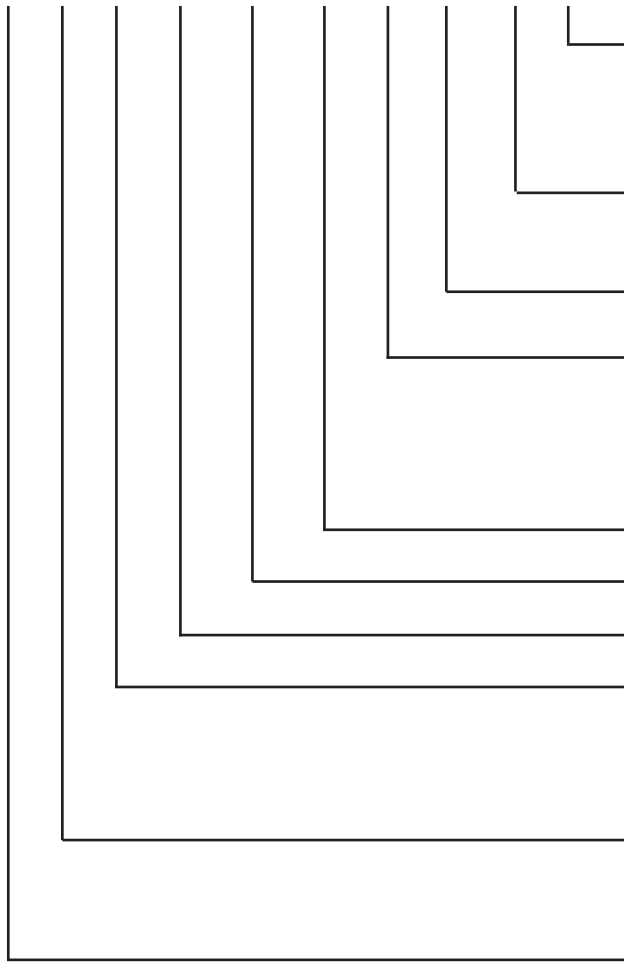

Options - May be in any order.  
 EU = Europe  
 F6 = 3 Motion Foot Control  
 H6 = 3 Motion Hand Control  
 CS = Casters

**Grommet:**  
 VN = Vanilla  
 BK = Black

**Fabric:**  
 TT = TerraTouch

**Padding:**  
 AC = AeroCel 4"  
 A6 = AeroCel 6"  
 PL = Plush  
 SF = SemiFirm  
 FM = Firm

Table Top Length  
 Minimum Table Height

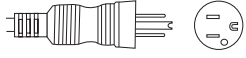

Table Top Width

**Top:**  
 FT = Flat  
 BR = Backrest  
 LS = Lift Assist Backrest  
 ES = Electric Salon

**Base:**  
 SL = Scissor Lift  
 MA = without base motor cover  
 EX = Medical Table

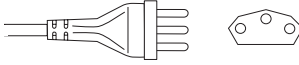
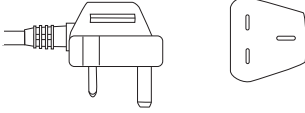
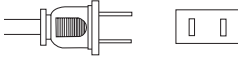

**Table Model:**  
 PX = ProLuxe  
 EP = Euphorian

## POWER LEAD PLUGS

OAKWORKS® Part #:	Voltage (AC)	Power Cord Plug	
5097-11	120v 60 Hz	3 prong grounded hospital grade; North America	
5097-3	220v 50/60 Hz	Continental Plug; Europe	
5097-4	220v 50 Hz	Swiss plug; Switzerland	
5097-2	220v 50 Hz	British plug; United Kingdom	
N/A (Plug comes w/ Control Box; order Control Box pn #4046-3)	100v 50 Hz	2 prong polarized plug; Japan	

**Damaged power cords should be replaced by qualified service personnel.**

## ELECTRICAL SPECIFICATIONS

Designed for:	North America	Europe	Japan
Input Service	120 VAC/60Hz/15A	230 VAC/50-60Hz/10A	100 VAC/50Hz/15A
Current Draw	2.7 amps	1.5 amps	3.3 amps
Maximum Momentary Current Draw	9.0 amps	5.0 amps	11.0 amps
Voltage Output (control box)	24 VDC	24 VDC	24 VDC
Electric Shock Protection	Class 1 Equipment	Class 1 Equipment	Class 1 Equipment
Tabletop Applied Part	 Type B Applied Part	 Type B Applied Part	 Type B Applied Part
Table Top IEC 529 Rating	IPX0	IPX0	IPX0
Mode of Operation	Intermittent Operation MAX 2 minutes ON 18 minutes OFF	Intermittent Operation MAX 2 minutes ON 18 minutes OFF	Intermittent Operation MAX 2 minutes ON 18 minutes OFF

## PERMISSIBLE ENVIRONMENTAL CONDITIONS

Conditions	Temperature	Humidity	Atmospheric Pressure
Normal Use	50° (10°C) to 100° (38°C)	20% to 60% RH	98 to 105 kPa
Storage & Transport	-20° (-29°C) to 135° (57°C)	20% to 95% RH	98 to 105 kPa

<b>Guidance and manufacturer’s declaration –electromagnetic emissions</b>		
The PROLUX TABLE is intended for use in the electromagnetic environment specified below. The customer or the user of the PROLUX TABLE should assure that it is used in such an environment.		
Emissions test	Compliance	Electromagnetic environment – guidance
RF emissions CISPR 11	Group 1	The PROLUX TABLE uses RF energy only for its internal function. Therefore, its RF emissions are very low and are not likely to cause any interference in nearby electronic equipment.
RF emissions CISPR 11	Class B	The PROLUX TABLE is suitable for use in all establishments other than domestic and those directly connected to the public low-voltage power supply network that supplies buildings used for domestic purposes.
Harmonic emissions IEC 61000-3-2	Class A	
Voltage fluctuations / flicker emissions IEC 61000-3-3	Complies	

<b>Recommended separation distances between portable and mobile RF communications equipment and the PROLUX TABLE</b>			
The PROLUX TABLE is intended for use in an electromagnetic environment in which radiated RF disturbances are controlled. The customer or the user of the PROLUX TABLE can help prevent electromagnetic interference by maintaining a minimum distance between portable and mobile RF communications equipment (transmitters) and the PROLUX TABLE as recommended below, according to the maximum output power of the communications equipment.			
Rated maximum output power of transmitter  W	Separation distance according to frequency of transmitter m		
	150 kHz to 80 MHz	80 MHz to 800 MHz	800 MHz to 2,5 GHz
	$d = 1.2\sqrt{P}$	$d = 1.2\sqrt{P}$	$d = 2.3\sqrt{P}$
0,01	0.12	0.12	0.23
0,1	0.38	0.38	0.73
1	1.20	1.20	2.30
10	3.79	3.79	7.27
100	12.00	12.00	23.00
For transmitters rated at a maximum output power not listed above, the recommended separation distance $d$ in metres (m) can be estimated using the equation applicable to the frequency of the transmitter, where $P$ is the maximum output power rating of the transmitter in watts (W) according to the transmitter manufacturer.			
NOTE 1 At 80 MHz and 800 MHz, the separation distance for the higher frequency range applies.			
NOTE 2 These guidelines may not apply in all situations. Electromagnetic propagation is affected by absorption and reflection from structures, objects and people.			

Guidance and manufacturer's declaration –electromagnetic immunity			
The PROLUX TABLE is intended for use in the electromagnetic environment specified below. The customer or the user of the PROLUX TABLE should assure that it is used in such an environment.			
Immunity test	IEC 60601 test level	Compliance level	Electromagnetic environment – guidance
Conducted RF IEC 61000-4-6	3 Vrms 150 kHz to 80 MHz	3 Vrms	<p>Portable and mobile RF communications equipment should be used no closer to any part of the [ME EQUIPMENT or ME SYSTEM], including cables, than the recommended separation distance calculated from the equation applicable to the frequency of the transmitter.</p> <p><b>Recommended separation distance</b></p> $d = 1.2\sqrt{P}$
Radiated RF IEC 61000-4-3	3 V/m 80 MHz to 2,5 GHz	3 V/m	<p><math>d = 1.2\sqrt{P}</math> 80 MHz to 800 MHz</p> <p><math>d = 2.3\sqrt{P}</math> 800 MHz to 2,5 GHz</p> <p>where <math>P</math> is the maximum output power rating of the transmitter in watts (W) according to the transmitter manufacturer and <math>d</math> is the recommended separation distance in metres (m).</p> <p>Field strengths from fixed RF transmitters, as determined by an electromagnetic site survey, <sup>a</sup>should be less than the compliance level in each frequency range. <sup>b</sup></p> <p>Interference may occur in the vicinity of equipment marked with the following symbol:</p> 
NOTE 1 At 80 MHz and 800 MHz, the higher frequency range applies.			
NOTE 2 These guidelines may not apply in all situations. Electromagnetic propagation is affected by absorption and reflection from structures, objects and people.			
<p><sup>a</sup> Field strengths from fixed transmitters, such as base stations for radio (cellular/cordless) telephones and land mobile radios, amateur radio, AM and FM radio broadcast and TV broadcast cannot be predicted theoretically with accuracy. To assess the electromagnetic environment due to fixed RF transmitters, an electromagnetic site survey should be considered. If the measured field strength in the location in which the PROLUX TABLE is used exceeds the applicable RF compliance level above, the PROLUX TABLE should be observed to verify normal operation. If abnormal performance is observed, additional measures may be necessary, such as re-orienting or relocating the PROLUX TABLE.</p> <p><sup>b</sup> Over the frequency range 150 kHz to 80 MHz, field strengths should be less than 1 V/m.</p>			

<b>Guidance and manufacturer's declaration –electromagnetic immunity</b>			
The PROLUX TABLE is intended for use in the electromagnetic environment specified below. The customer or the user of the PROLUX TABLE should assure that it is used in such an environment.			
<b>Immunity test</b>	<b>IEC 60601 test level</b>	<b>Compliance level</b>	<b>Electromagnetic environment – guidance</b>
Electrostatic discharge (ESD) IEC 61000-4-2	±6 kV contact ±8 kV air	±6 kV contact ±8 kV air	Floors should be wood, concrete or ceramic tile. If floors are covered with synthetic material, the relative humidity should be at least 30 %.
Electrical fast transient/burst IEC 61000-4-4	±2 kV for power supply lines ±1 kV for input/output lines	±2 kV for power supply lines ±1 kV for input/output lines	Mains power quality should be that of a typical commercial or hospital environment.
Surge IEC 61000-4-5	±1 kV differential mode ±2 kV common mode	±1 kV differential mode ±2 kV common mode	Mains power quality should be that of a typical commercial or hospital environment.
Voltage dips, short interruptions and voltage variations on power supply input lines IEC 61000-4-11	<5 % $U_T$ (>95 % dip in $U_T$ ) for 0,5 cycle  40 % $U_T$ (60 % dip in $U_T$ ) for 5 cycles  70 % $U_T$ (30 % dip in $U_T$ ) for 25 cycles  <5 % $U_T$ (>95 % dip in $U_T$ ) for 5 sec	<5 % $U_T$ (>95 % dip in $U_T$ ) for 0,5 cycle  40 % $U_T$ (60 % dip in $U_T$ ) for 5 cycles  70 % $U_T$ (30 % dip in $U_T$ ) for 25 cycles  <5 % $U_T$ (>95 % dip in $U_T$ ) for 5 sec	Mains power quality should be that of a typical commercial or hospital environment. If the user of the PROLUX TABLE requires continued operation during power mains interruptions, it is recommended that the PROLUX TABLE be powered from an uninterruptible power supply or a battery.
Power frequency (50/60 Hz) magnetic field IEC 61000-4-8	N/A	N/A	Power frequency magnetic fields should be at levels characteristic of a typical location in a typical commercial or hospital environment.
NOTE $U_T$ is the a.c. mains voltage prior to application of the test level.			



---

---

THIS PAGE INTENTIONALLY LEFT BLANK

---

THIS PAGE INTENTIONALLY LEFT BLANK

---

---

THIS PAGE INTENTIONALLY LEFT BLANK

# INSTRUCTION MANUAL

---

## ProLuxe™ *Series*

### CONTACT INFORMATION:

#### OAKWORKS® Inc.

923 East Wellspring Road  
New Freedom, PA 17349

Phone: 717-235-6807

FAX: 717-235-6798

[www.oakworks.com](http://www.oakworks.com)

---



#### European Authorized Representative

*Emergo Europe*

Molenstraat 15  
The Hague, 2513 BH Netherlands  
Tel: +31 70 3458570  
Fax: +31 70 3467299



**Intertek**

3034177

CONFORMS TO:  
ANSI/AAMI STD ES60601-1  
IEC STD 60601-1 3RD EDITION  
IEC STD 60601-1-2 3RD EDITION  
IEC STD 60601-1-6 3RD EDITION  
CERTIFIED TO CAN/CSA STD C22.2 NO. 60601-1  
CB TEST CERTIFICATE AND REPORT

Manual Part Number MMMNST0024

Revision date: 07.03.13

Edition 1, English

Printed in USA

made in the USA  
with US & imported parts



# OAKWORKS®