

SECTION A-A

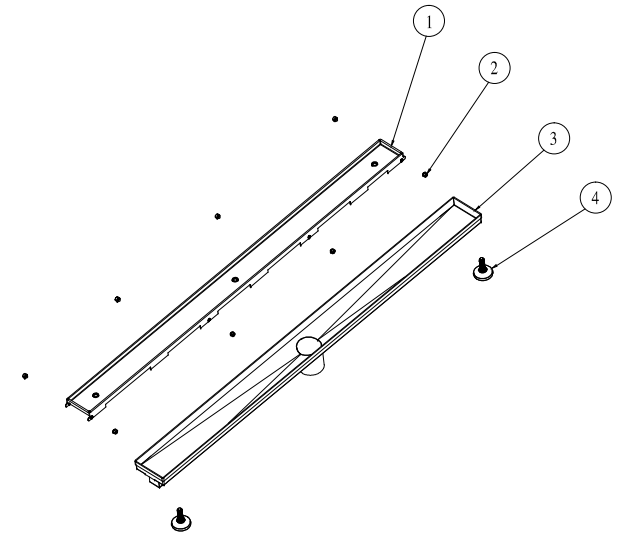

BAI 0555 Linear Drain

NO	DESCRIPTION	QTY	MATERIAL	SIZE
1	Linear drain cover	1	SUS304	35 $\frac{3}{4}$ "X2 $\frac{1}{4}$ "X $\frac{3}{4}$ "(18G)
2	plastic connectors	8	PP	ϕ $\frac{3}{8}$ "X $\frac{9}{16}$ "
3	Linear drain stand	1	SUS304	36"X3"X3 $\frac{3}{8}$ "(18G)
4	mounting brackets	2	composite material	ϕ 1 $\frac{1}{16}$ "X1 $\frac{1}{16}$ "

www.megabai.com

Type:	Linear drain	Material:	SUS304
Model:	SD-SF0555-36	Feature:	18/8 Chrome-Nickel
Size/Overall:			Polished, Stain Finish
Scale:			
Design:	BAI		
Drawn:			
Date:	2014-03-27	Logo:	
Manufacture Date:		Approved:	