

BathLux4

HEAT FAN LIGHT 3 IN 1 – WHITE & SILVER



FEATURES

- Instant infrared heat
- Long life ball bearing motor
- Energy efficient LED light
- Easy clean and installation
- Side ducting with draft stopper
- Internal thermal safety switch

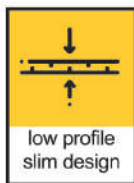

SPECIFICATION

Model	MBHB4WH, MBHB4S
Voltage	230 - 240V 50Hz
Motor	34W ball bearing
Air Flow	≤240 m ³ /h
Noise	≤45dB
LED Light	7W R80 6000K daylight
Grille Size	365 x 365mm
Cut Out	300 x 300mm
Duct	Ø100mm

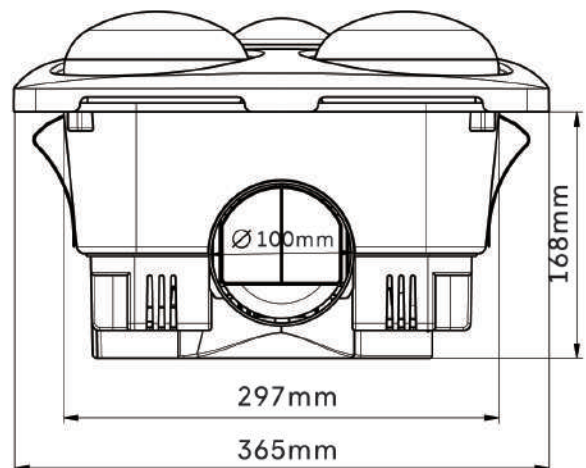

self closing back shutter

INCLUDES

• 4 x 275w infrared instant heat lamps	• 2 x duct clips
• 1 x 4 gangs wall switch	• 1 x external grille
• 1 x 1.5m aluminum ducting	

