

ZONE

4 WIRE 3 CIRCUIT LED TRI-CCT DIMMABLE TRACK HEAD & ACCESSORIES

These modular LED track heads with their quick assembly and tool-free replacement design, reduces cost and time. A multitude of available optical accessories like lenses and reflectors offer customization to suit various lighting needs.

- Input voltage: 220-240V
- Faceplate & housing: powder coated aluminium
- Diffuser: glass
- Heatsink: aluminium
- Tri-CCT: 2700K/ 4000K/ 6000K in one fitting
- LED chip: 1pc COB LED
- Rear switch
- Power factor: 0.92
- CRI: ≥90
- Tilt: 90° / Swivel: 355°
- Ambient temperature: -20 to 40°C
- Suitable for dimming
- Suitable for 2-way switching



ZONE1BK
(INCLUDES ZONERING1BK & ZONEREF1)

30,000hr Lifetime	36° Beam Angle	IP20 Rated	3YEAR Replacement Warranty
-------------------	----------------	----------------------	--------------------------------------

DIMMABLE	
----------	--



ZONE1WH
(INCLUDES ZONERINGWH & ZONEREF1)

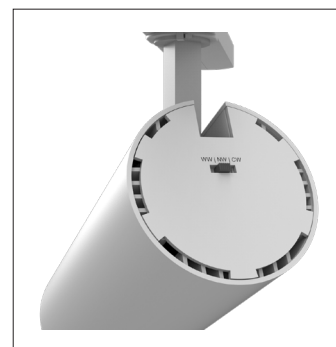

REAR CCT SWITCH

Tested & Recommended Dimmers:

Brand	Part No.
CLA	VELA
CLIPSAL	32ELEDM, 32E450TM, 31E2RUDM, 32E450UDM
DIGINET	MEDM
SCHNEIDER	SBD200LED, SBDB15RC

*Please check with Licenced electrician for Min and Max dimmer load

*May be compatible with other untested dimmers

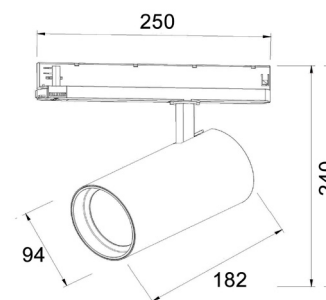

Part No.	Description	Lumens			Watt	CRI	Box Weight	Box Dimensions	Carton QTY
		2700K	4000K	6000K					
ZONE1BK	TRACK 4 WIRE 3 Circuit LED HEAD BLK	2310lm	2580lm	2460lm	30W	≥90	1.10kg	27x21x13cm	1/8
ZONE1WH	TRACK 4 WIRE 3 Circuit LED HEAD WH	2610lm	2860lm	2770lm	30W	≥90	1.10kg	27x21x13cm	1/8

TRACK HEAD ACCESSORIES

1. Track Head Rings

INCLUDED



ZONERING1BK
(Standard)

INCLUDED



ZONERING1WH
(Standard)

Standard Ring Set
Included in ZONE1BK or
ZONE1WH
Ø95mm

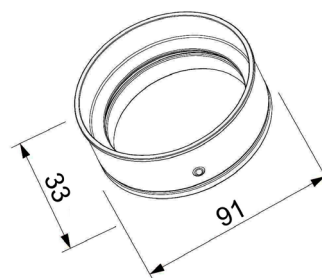

ZONERING2BK
(Optional)



ZONERING2WH
(Optional)

Optional Ring Set
Ø95mm

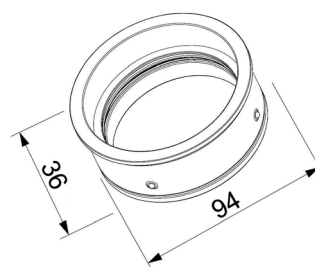

2. Track Head Reflector

INCLUDED



ZONEREF1 (Standard)

Standard Reflector
Included in ZONE1BK or ZONE1WH
Aluminium with glass lens
Ø75mm

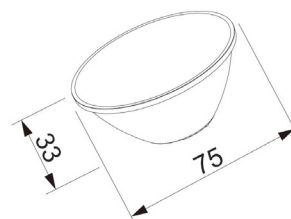
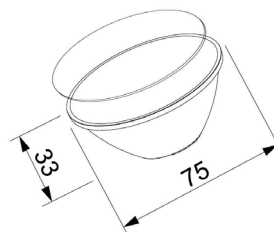

3. Track Head Lens (15° & 36°)



ZONE36LENS1
(Standard)
36D Ø75mm



ZONE15LENS1
(Standard)
15D Ø75mm



ZONE36LENS2
(Optional)
Highlight Soft 36D Ø75mm

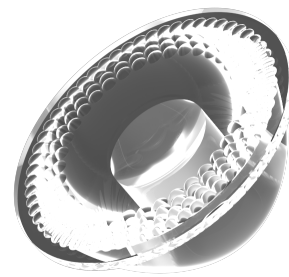

ZONE36LENS3
(Optional)
Gradual Change Soft
36D Ø75mm

4. Track Head Beam Shaping Filters (Ø75mm)

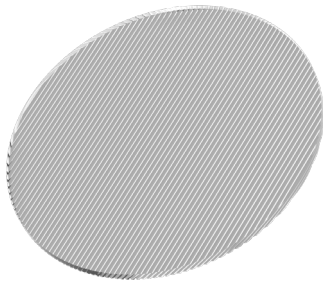

ZONE15FILTER1
(Narrow and long for use with lens)

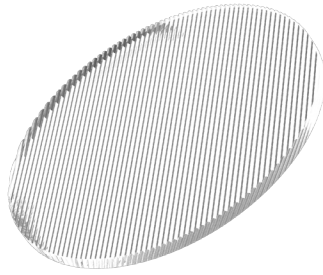

ZONE15FILTER2
(Wide and short for use with lens)

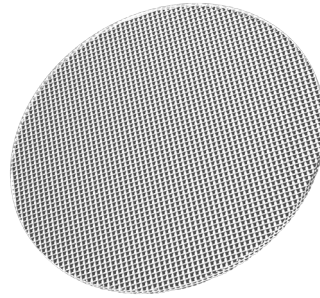

ZONE15FILTER3
(Square for use with lens)

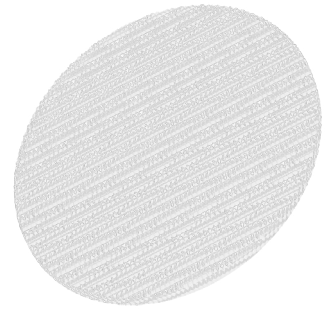

ZONE15FILTER4
(Wall Wash for use with lens)

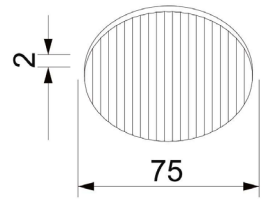
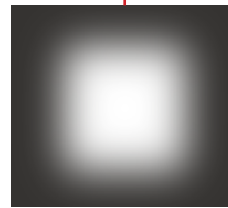
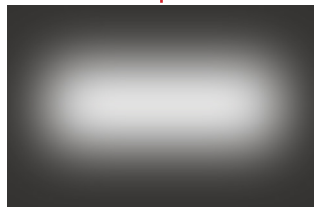
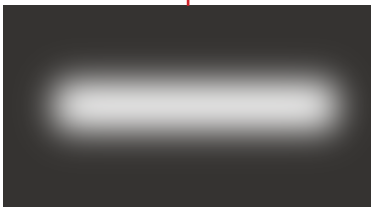

Use the additional accessory to change the light shape. **Can be used with standard ZONERING1 & optional ZONERING2**

5. Track Head Lens Colour Kits



ZONECOLOUR

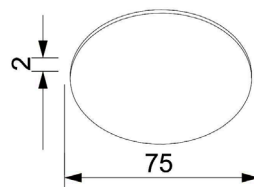

7 Piece colour lens kits (red, green, blue, yellow, orange, purple & tawny)

Material: P/C

For Ring 2 System

Ø75mm

Can be used with standard ZONERING1 & optional ZONERING2



6. Track Head Honeycomb Filter (Anti Glare Mesh Ø75mm)

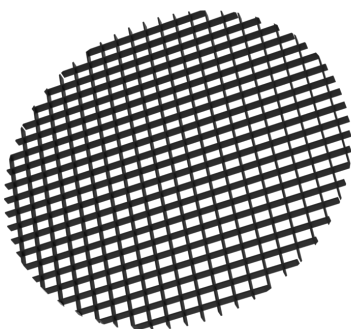

ZONEHONEY
(Optional)

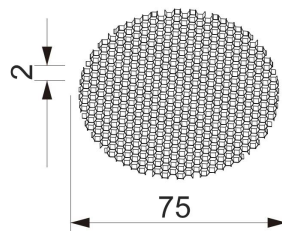

7. Track Head Barns

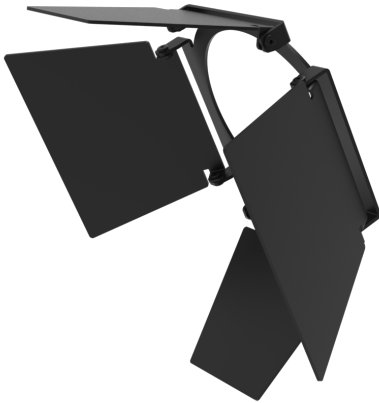

ZONEBARNBK
(Optional)

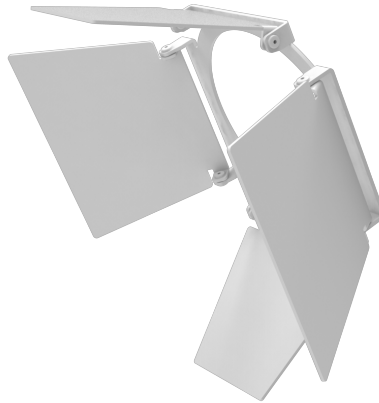

ZONEBARNWH
(Optional)

Barn door
L105 X W105 X H85mm

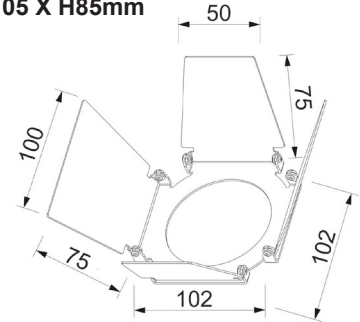

8. Track Head Shades



ZONESHADE1BK
(Optional)



ZONESHADE1WH
(Optional)

Shade (Wide Spread)
Ø75mm

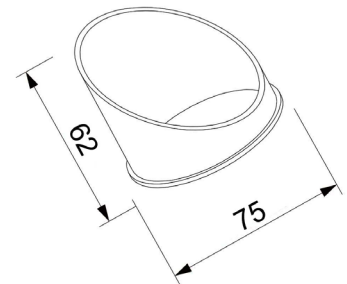

ZONESHADE2BK
(Optional)



ZONESHADE2WH
(Optional)

Shade (Partial)
Ø75mm

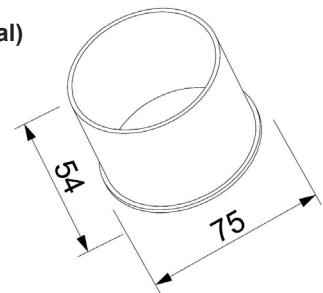

TRACK HEAD COMBINATION

(Shown with ZONERING2)



FRONT RINGS

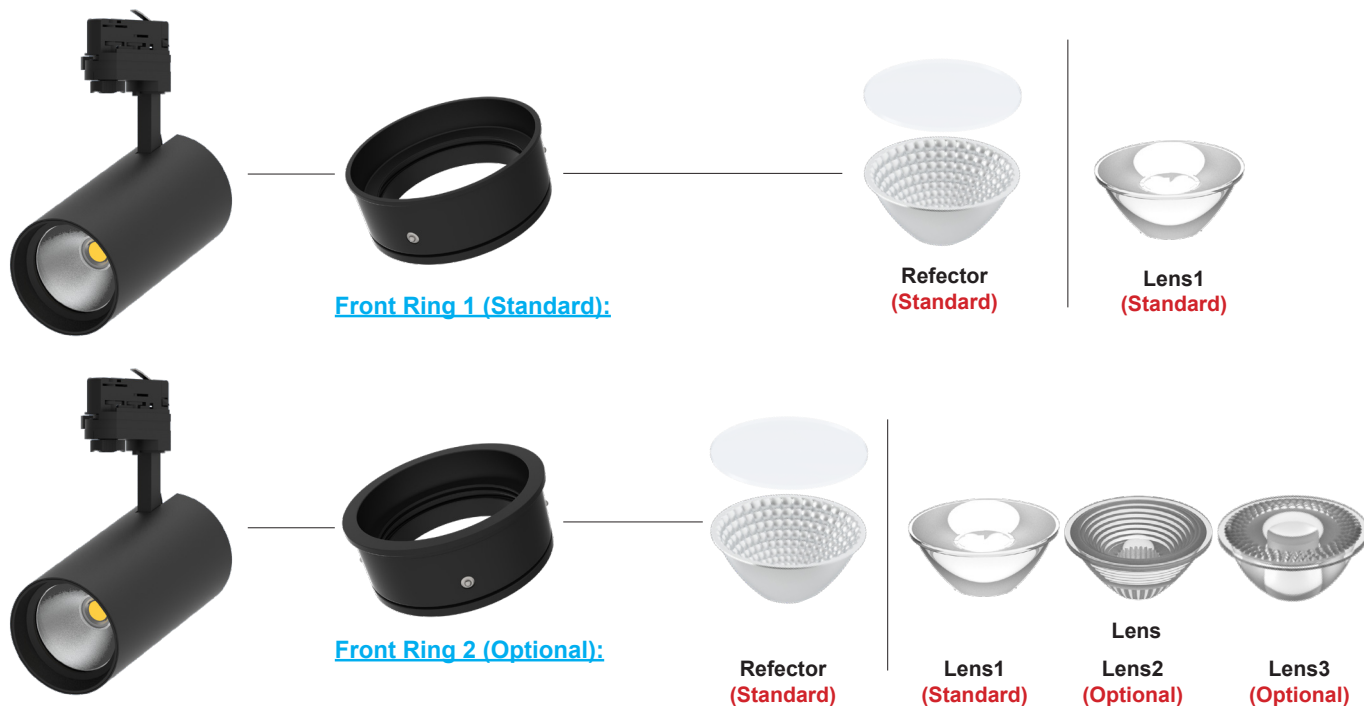

For more information, please visit the link below to watch the instruction video:
<https://youtu.be/GZi3S-9qEkk>