

14.4w IP20 12v DC RGB + 3000k LED Strip

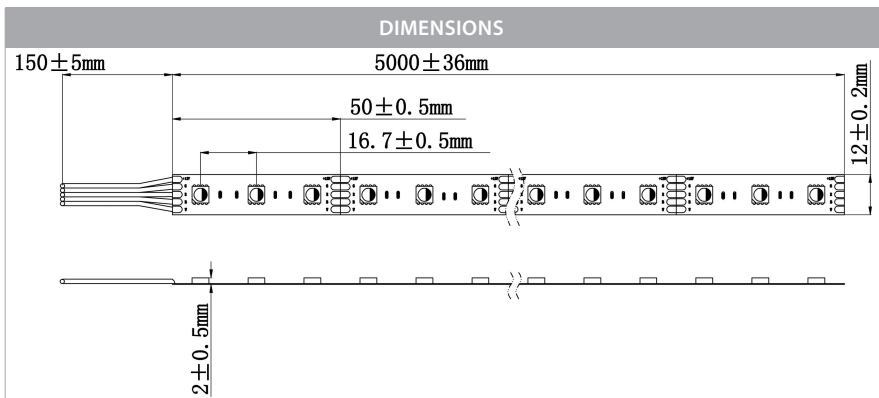





PRODUCT SPECIFICATIONS

Watts Per Metre: 14.4w
Input Voltage: 12v DC
Colour Temp: RGBW (Red, Green, Blue + 3000k)
CRI: >80
Beam Angle: 120°
IP Rating: IP20
Size: 12mm x 2mm
PCB: 3oz
Dimmable: Yes
LED Chip Type: 5050
LED Chips Per Metre: 60 LED'S
Lumens Per Metre: 550lm (3000k)
Maximum Length: 5000mm
Cutting Increments: Every 50mm
Wiring: Parallel
Mounting: Aluminium Profile or Heat Sink
Warranty: 2 Years Replacement**



Product Ordering

| IMAGE | PART NUMBER |
|---|----------------------------|
|     | HV9751-IP20-60-RGBW |

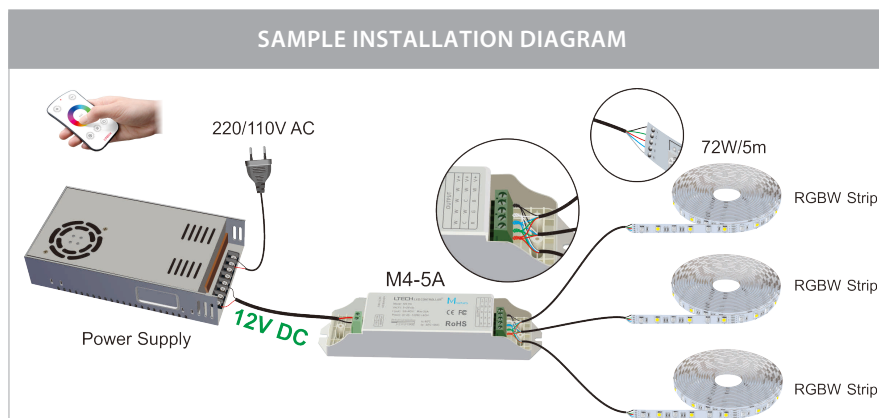

Must be used with a suitable 12v DC LED Driver + RGBW Controller

* Lumens measured @ source
 **See Warranty Terms and Conditions for more information

For more information contact Havit Lighting

ADDRESS:
 143 Beauchamp Road
 Matraville NSW 2036
 Australia

Tel: 02 9381 8300
 Fax: 02 9666 8881
 Email: sales@havit.com.au
 web: www.havit.com.au

14.4w IP54 12v DC RGB + 3000k LED Strip





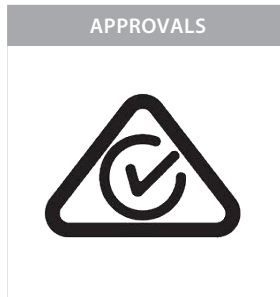
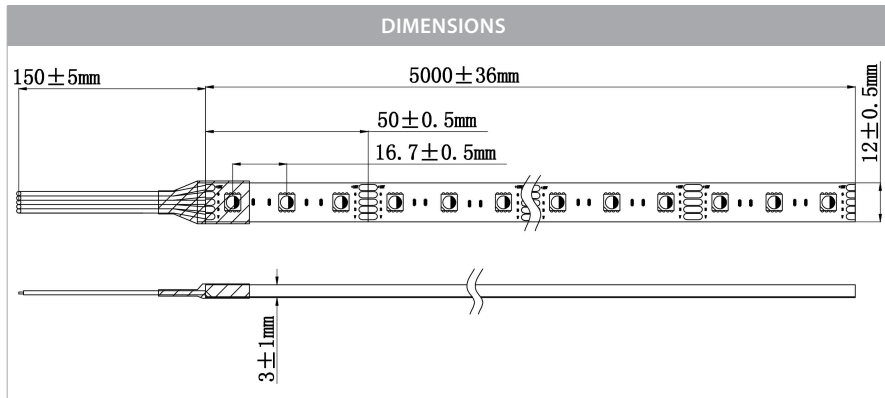
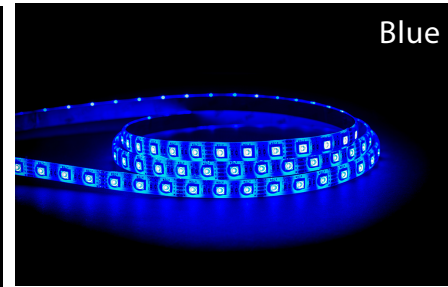
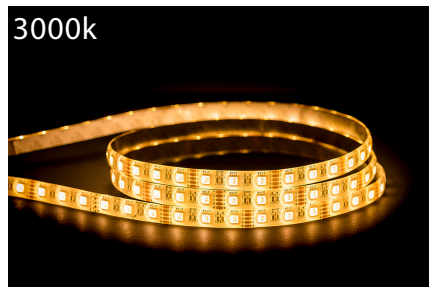

PRODUCT SPECIFICATIONS

Watts Per Metre: 14.4w
Input Voltage: 12v DC
Colour Temp: RGBW (Red, Green, Blue + 3000k)
CRI: >80
Beam Angle: 120°
IP Rating: IP54
Size: 12mm x 3mm
PCB: 3oz
Dimmable: Yes
LED Chip Type: 5050
LED Chips Per Metre: 60 LED'S
Lumens Per Metre: 550lm (3000k)
Maximum Length: 5000mm
Cutting Increments: Every 50mm
Wiring: Parallel
Mounting: Aluminium Profile or Heat Sink
Warranty: 2 Years Replacement**



Product Ordering

| IMAGE | PART NUMBER |
|---|----------------------------|
|     | HV9751-IP54-60-RGBW |

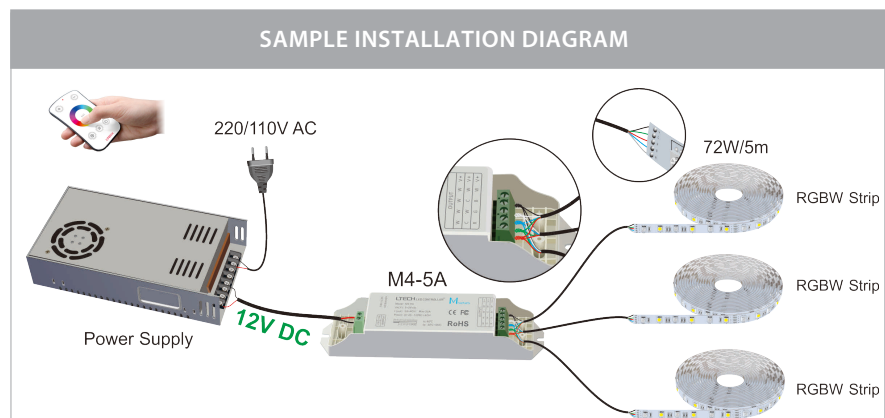

Must be used with a suitable 12v DC LED Driver + RGBW Controller

* Lumens measured @ source
 **See Warranty Terms and Conditions for more information

For more information contact Havit Lighting

ADDRESS:
 143 Beauchamp Road
 Matraville NSW 2036
 Australia

Tel: 02 9381 8300
 Fax: 02 9666 8881
 Email: sales@havit.com.au
 web: www.havit.com.au

14.4w IP67 12v DC RGB + 3000k LED Strip



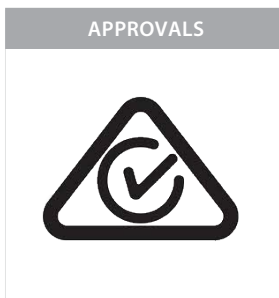
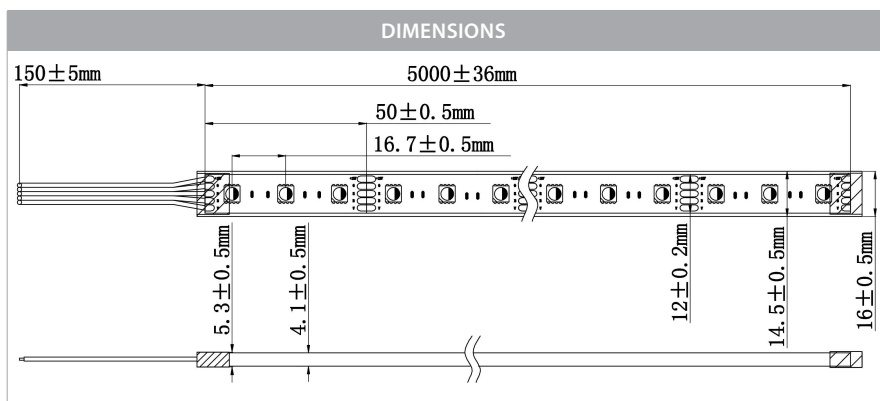
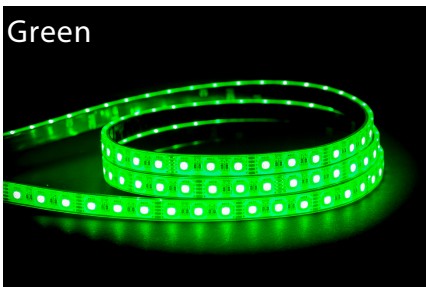

PRODUCT SPECIFICATIONS

- Watts Per Metre:** 14.4w
- Input Voltage:** 12v DC
- Colour Temp:** RGBW (Red, Green, Blue + 3000k)
- CRI:** >80
- Beam Angle:** 120°
- IP Rating:** IP67
- Size:** 16mm x 6mm (Including End Caps)
- PCB:** 3oz
- Dimmable:** Yes
- LED Chip Type:** 5050
- LED Chips Per Metre:** 60 LED'S
- Lumens Per Metre:** 550lm (3000k)
- Maximum Length:** 5000mm
- Cutting Increments:** Every 50mm
- Wiring:** Parallel
- Mounting:** Aluminium Profile or Heat Sink
- Warranty:** 2 Years Replacement**

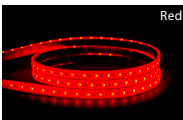

Product Ordering

| IMAGE | PART NUMBER |
|--|----------------------------|
|     | HV9751-IP67-60-RGBW |

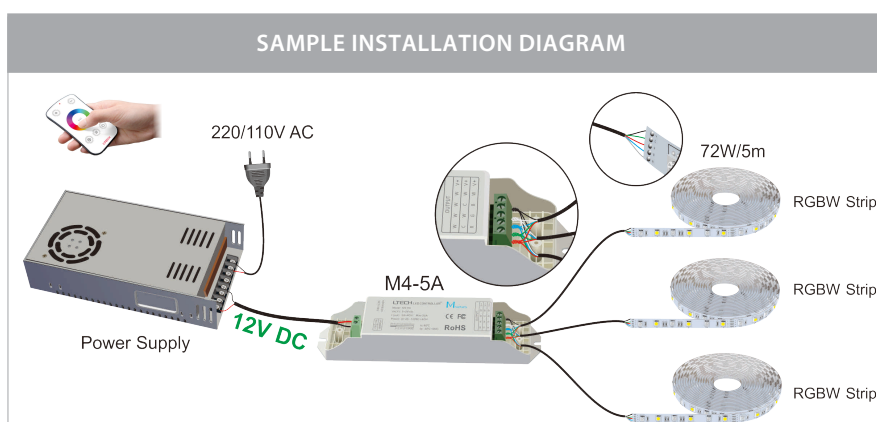

Must be used with a suitable 12v DC LED Driver + RGBW Controller

* Lumens measured @ source

**See Warranty Terms and Conditions for more information

For more information contact Havit Lighting

ADDRESS:
143 Beauchamp Road
Matraville NSW 2036
Australia

Tel: 02 9381 8300
Fax: 02 9666 8881
Email: sales@havit.com.au
web: www.havit.com.au