

GU10 EXTERIOR WALL PILLAR LIGHTS (Titanium)

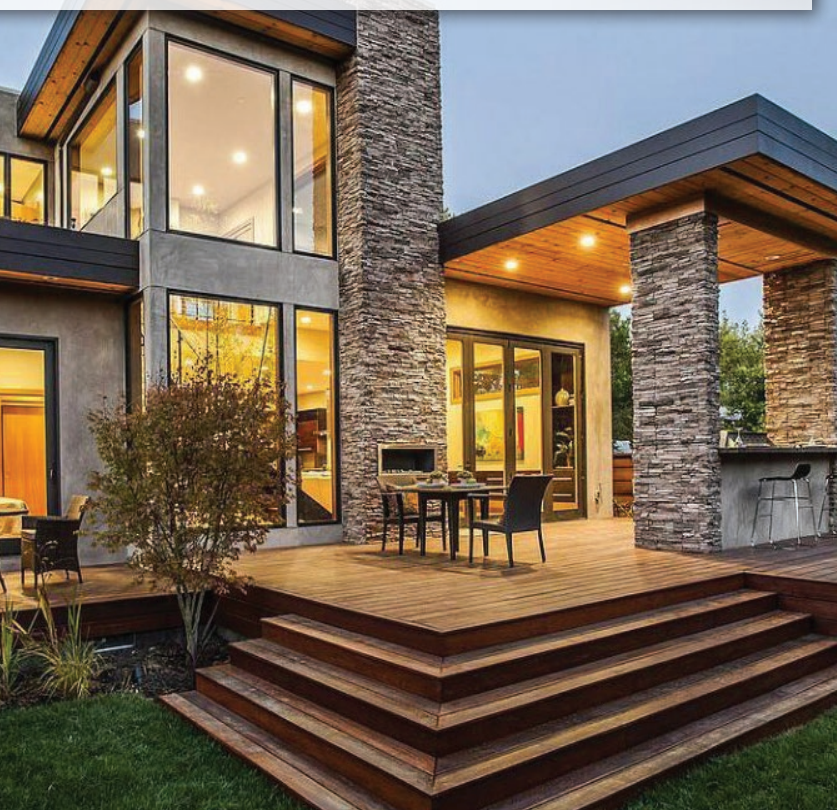

Exterior Lighting



PGUDT



PG1FT



PG1AT



PG2AT

PRODUCT FEATURES

- Input voltage range: 110-265V AC 50/60Hz
- Material: anodized aluminium
- Colour: titanium
- Lamp holder: GU10 (Max 35W halogen globe)
- Globes not included

GU10	IP65 Rated	2YEAR Replacement Warranty
------	----------------------	-----------------------------------------

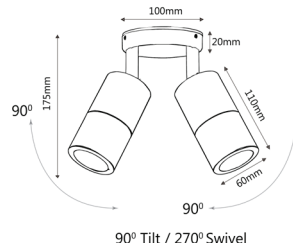
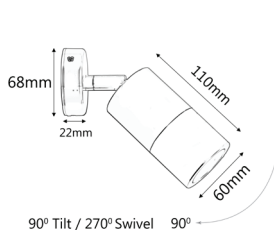
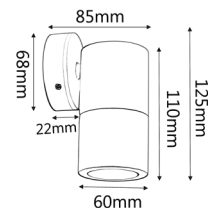
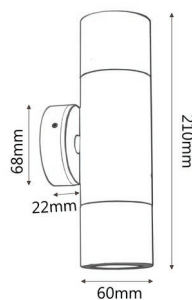

PART NO.	DESCRIPTION	QTY OF GLOBES	WEIGHT (KG)	BOX (CM)	CARTON QTY
PGUDT	WALL GU10 X 2 (Max 35W HAL) PILLAR UP/DN TITANIUM	2XGU10	0.60	23X10X8.5	1/20
PG1FT	WALL GU10 (Max 35W HAL) PILLAR FIXED TITANIUM	1XGU10	0.40	15X10X8	1/20
PG1AT	WALL GU10 (Max 35W HAL) PILLAR S/ADJ TITANIUM	1XGU10	0.40	19.5X8X8	1/20
PG2AT	WALL GU10 X 2 (Max 35W HAL) PILLAR D/ADJ RND BASE TITANIUM	2XGU10	0.75	19X12X12	1/10

GU10 EXTERIOR BAR LIGHTS (Titanium)



Exterior Lighting



PG2BART



PG3BART



PG4BART



PG4SQT

PRODUCT FEATURES

- Input voltage range: 110-265V AC 50/60Hz
- Material: anodized aluminium
- Colour: titanium
- Lamp holder: GU10 (Max 35W halogen globe)
- Globes not included

GU10	IP44 Rated	2YEAR Replacement Warranty
------	----------------------	-----------------------------------------

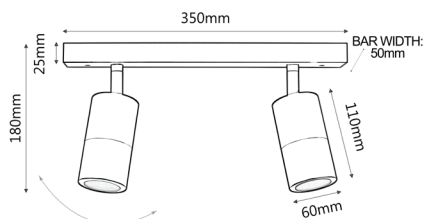

90° Tilt / 270° Swivel on all heads

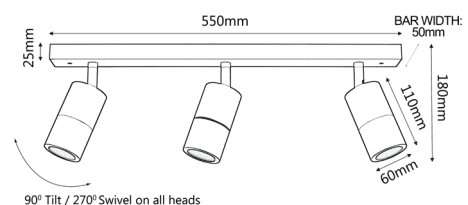

90° Tilt / 270° Swivel on all heads

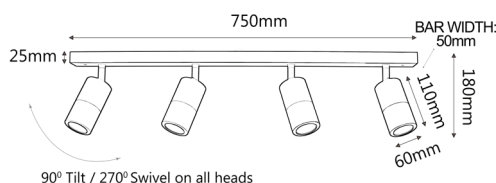

90° Tilt / 270° Swivel on all heads

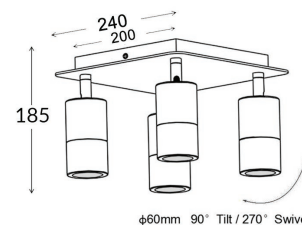

PART NO.	DESCRIPTION	QTY OF GLOBES	WEIGHT (KG)	BOX (CM)	CARTON QTY
PG2BART	WALL GU10 X 2 (Max 35W HAL) PILLAR D/ADJ BAR TITANIUM	2XGU10	1.00	37X21X8	1/10
PG3BART	WALL GU10 X 3 (Max 35W HAL) PILLAR 3 Light BAR TITANIUM	3XGU10	1.50	57X21X8	1/10
PG4BART	WALL GU10 X 4 (Max 35W HAL) PILLAR 4 Light BAR TITANIUM	4XGU10	2.00	66.5X21X8	1/10
PG4SQT	WALL GU10 X 4 PILLAR 4 Light BAR SQ TITANIUM	4XGU10	1.98	27x27x21	1/4

GU10 EXTERIOR WALL PILLAR LIGHTS (WHITE)



Exterior Lighting



PGUDWH



PG1FWH



PG1AWH



PG2AWH

PRODUCT FEATURES

- Input voltage range: 110-265V AC 50/60Hz
- Material: aluminium
- Colour: powder coated white
- Max 35W halogen globe(s)
- Lamp holder: GU10 (Max.35W halogen globes)
- Globes not included

 GU10	IP65 Rated	2YEAR Replacement Warranty
-------------------------------------------------------------------------------------------------	----------------------	-----------------------------------------

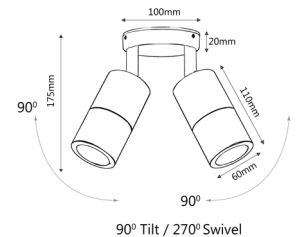
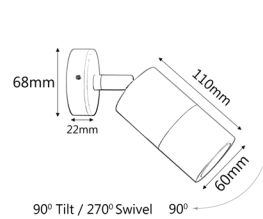
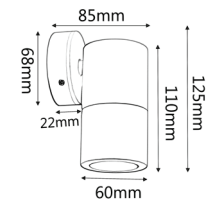
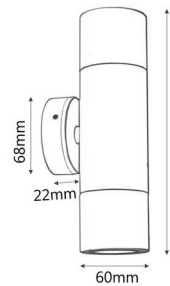

PART NO.	DESCRIPTION	LAMP HOLDER	MAX. WATT	BACK PLATE (mm)	WEIGHT (KG)	BOX (CM)	CARTON QTY
PGUDWH	WALL GU10 X 2 PILLAR UP/DN WH	2xGU10	2x35W	ø68x22	0.58	22.5 x 9.5 x 8.5	1/20
PG1FWH	WALL GU10 PILLAR FIXED WH	1xGU10	35W	ø68x22	0.40	15 x 10 x 8	1/20
PG1AWH	WALL GU10 PILLAR S/ADJ WH 90D Tilt 270D	1xGU10	35W	ø68x22	0.42	19.5 x 8 x 8	1/25
PG2AWH	WALL GU10X2 PILLAR D/ADJ RND BASE WH 90D Tilt 270D	2xGU10	2x35W	ø100x20	0.75	19 x 12 x 12	1/10

GU10 EXTERIOR BAR LIGHTS (White)



PG2BARWH



PG3BARWH



PG4BARWH



PG4SQWH

PRODUCT FEATURES

- Input voltage range: 110-265V AC 50/60Hz
- Material: aluminium
- Colour: powder coated white
- Lamp holder: GU10 (Max.35W halogen globes)
- Globes not included

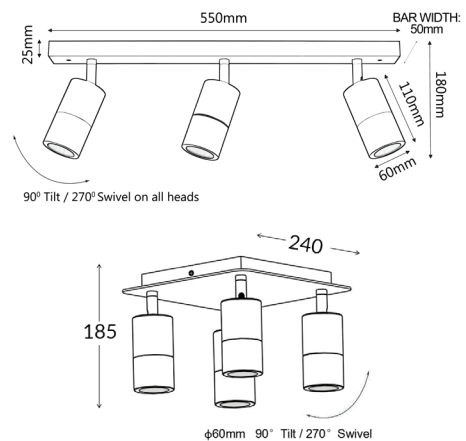
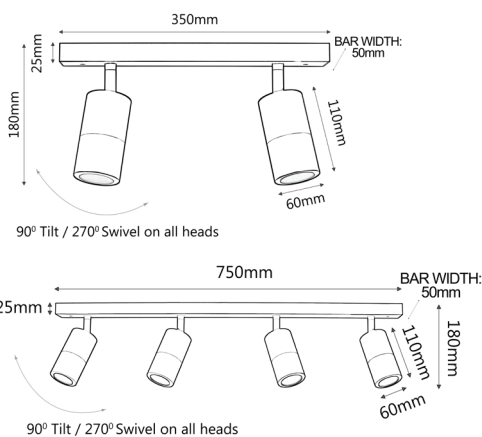

PART NO.	DESCRIPTION	LAMP HOLDER	MAX. WATT	BACK PLATE(mm)	WEIGHT (KG)	LENGTH (CM)	CARTON QTY
PG2BARWH	WALL GU10 X 2 PILLAR D/ADJ BAR WH	2xGU10	2x35W	350x50x25	1.07	7.4x20.7x36.7	1/10
PG3BARWH	WALL GU10 X 3 PILLAR 3 Light BAR WH	3xGU10	3x35W	550x50x25	1.53	7x20.5x56.5	1/10
PG4BARWH	WALL GU10 X 4 PILLAR 4 LIGHT BAR WH	4xGU10	4x35W	750x50x25	2.00	7.5x20x76.5	1/10
PG4SQWH	WALL GU10 X 4 PILLAR 4 Light BAR SQ WH	4xGU10	4x35W	240x240	2.03	26.5x26.5x21.5	1/4

GU10 EXTERIOR WALL PILLAR LIGHTS (Black)



PGUDBL



PG1FBL



PG1ABL



PG2ABL

Exterior Lighting

PRODUCT FEATURES

- Input voltage range: 110-265V AC 50/60Hz
- Material: aluminium
- Colour: powder coated black
- Lamp holder: GU10 (Max 35W halogen globe)
- Globes not included

GU10

IP65

Rated

2YEAR

Replacement
Warranty

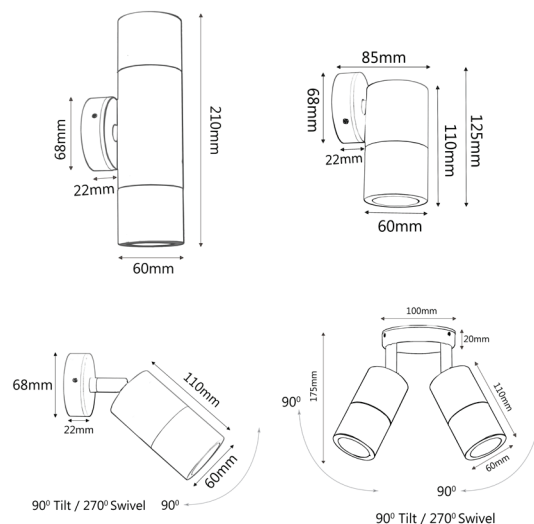

PART NO.	DESCRIPTION	QTY OF GLOBES	WEIGHT (KG)	BOX (CM)	CARTON QTY
PGUDBL	WALL GU10 X 2 (Max 35W HAL) PILLAR UP/DN BLK	2xGU10	0.64	24 x 9.6 x 8.5	1/20
PG1FBL	WALL GU10 X 2 (Max 35W HAL) PILLAR UP/DN BLK	1xGU10	0.8	14 x 10 x 8	1/20
PG1ABL	WALL GU10 (Max 35W HAL) PILLAR S/ADJ BLK	1xGU10	0.42	19 x 8 x 8	1/25
PG2ABL	WALL GU10 X 2 (Max 35W HAL) PILLAR D/ADJ RND BASE BLK	2xGU10	0.8	19 x 22 x 20	1/10

GU10 EXTERIOR BAR LIGHTS (Black)



Exterior Lighting



PG2BARBL



PG3BARBL



PG4BARBL



PG4SQBL

PRODUCT FEATURES

- Input voltage range: 110-265V AC 50/60Hz
- Material: aluminium
- Colour: powder coated black
- Lamp holder: GU10 (Max 35W halogen globe)
- Globes not included

GU10	IP44 Rated	2YEAR Replacement Warranty
------	----------------------	-----------------------------------------

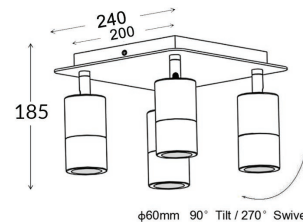
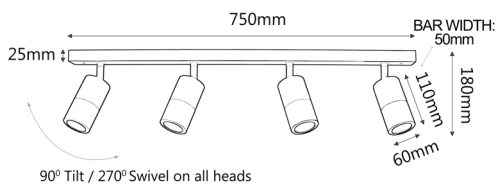
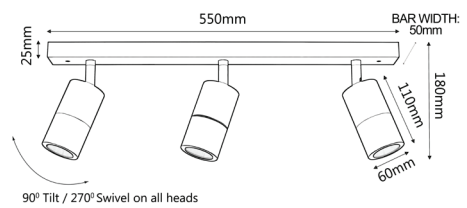
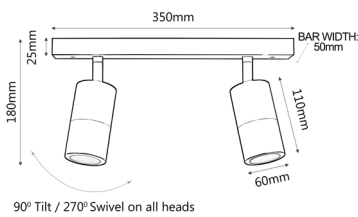

PART NO.	DESCRIPTION	QTY OF GLOBES	WEIGHT (KG)	LENGTH (CM)	CARTON QTY
PG2BARBL	WALL GU10 X 2 (Max 35W HAL) PILLAR D/ADJ BAR BLK	2XGU10	1.00	37x21x8	1/10
PG3BARBL	WALL GU10 X 3 (Max 35W HAL) PILLAR 3 Light BAR BLK	3XGU10	1.50	57x21x8	1/10
PG4BARBL	WALL GU10 X 4 (Max 35W HAL) PILLAR 4 Light BAR BLK	4XGU10	2.00	66.5x21x8	1/10
PG4SQBL	WALL GU10 X 4 PILLAR 4 Light BAR SQ BLK	4XGU10	1.98	27x27x21	1/4