

NOVACOB01

LED Dimmable with **MAGNETIC CHANGEABLE FACEPLATE** Recessed Downlights

TRI-CCT

3000K	4000K	5700K
-------	-------	-------

- Input voltage range: 220-240V 50/60Hz
- Inbuilt constant current driver included
- Housing: aluminium & plastic
- Faceplate: powder coated aluminium
- Diffuser: PC
- Tri-CCT (3000K/ 4000K/ 5700K) in one fitting
- CCT switch on rear
- LED chip: 1PC COB SMD2835
- Power factor: 0.9
- CRI: ≥80
- Flex & plug: 0.6m
- Ambient temperature: -20 to 40°C
- Suitable for dimming
- Suitable for 2-way switching
- Suitable for use with sensors



General Lighting

Box Include:

- 1x Downlight (NOVACOB)
- 1x Loose Satin Chrome (NOVADSC) faceplate
- 1x Loose White faceplate

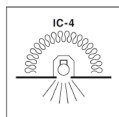

NOVACOB01



NOVADSC

Tested & Recommended Dimmers:

BRAND	PART NO.	PCS PER DIMMER
CLA	LYNX	1-10PCS
CLIPSAL	32E450TM	
HPM	CAT400T	
DIGINET	MEDM, MMDM/RT	

Available faceplates (Sold Separately):

- Matt Black (NOVADBLK)
- Antique Brass (NOVADBR)



NOVADBR

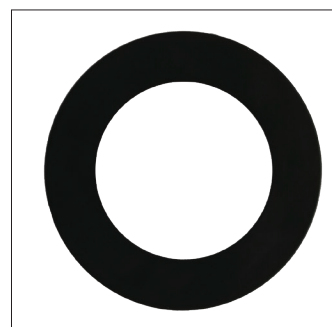

NOVADBLK

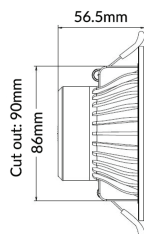

NOVACOB01 line drawing

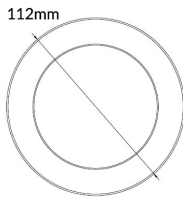
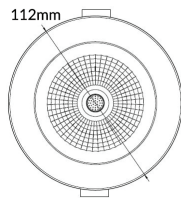

FACEPLATE line drawing

PART NO.	DESCRIPTION	LUMENS			WATT	CUT OUT	BOX WEIGHT	BOX DIMENSIONS	CARTON QTY
		3000K	4000K	5700K					
NOVACOB01	D/L LED COB FIXED WH+S/C DIMM RND TRI	800LM	950LM	850LM	10W	Ø90mm	0.26kg	12x12x7cm	1/40
NOVADBLK	FACEPLATE TO SUIT NOVADLUX01 & NOVACOB01 MATT BLK OD 112mm								
NOVADBR	FACEPLATE TO SUIT NOVADLUX01 & NOVACOB01 ANTIQUE BRASS OD 112mm								

NOVADLUX01

LED Dimmable with **MAGNETIC CHANGEABLE FACEPLATE** Recessed Downlights

TRI-CCT 3000K 4000K 5700K

- Input voltage range: 220-240V 50/60Hz
- Inbuilt constant current driver included
- Housing: aluminium & plastic
- Faceplate: powder coated aluminium
- Diffuser: frosted PC
- Tri-CCT (3000K/ 4000K/ 5700K) in one fitting
- CCT switch on rear
- LED chip: 24pcs SMD2835
- Power factor: 0.9
- CRI: ≥80
- Flex & plug: 600mm
- Ambient temperature: -20 to 40°C
- Suitable for dimming
- Suitable for 2-way switching
- Suitable for use with sensors

30,000hr
Lifetime

120°
Beam Angle

IP44
Rated

DIMMABLE

3YEAR
Replacement
Warranty

IC-4

Tested & Recommended Dimmers:

BRAND	PART NO.	PCS PER DIMMER
CLA	LYNX	NOVADLUX01: 1-10PCS
CLIPSAL	32E450TM	
HPM	CAT400T	
DIGINET	MEDM, MMDM/RT	



NOVADLUX01 Box Include:

- 1x Downlight (NOVADLUX01)
- 1x Loose Satin Chrome (NOVADSC) faceplate
- 1x White faceplate

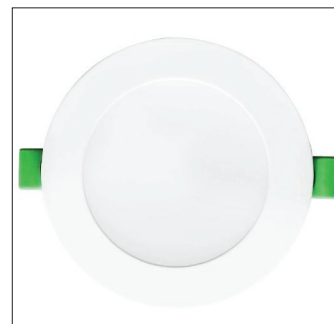

NOVADLUX01



NOVADSC

Available faceplates (Sold Separately):

- Matt Black (NOVADBLK)
- Antique Brass (NOVADBR)



NOVADBR

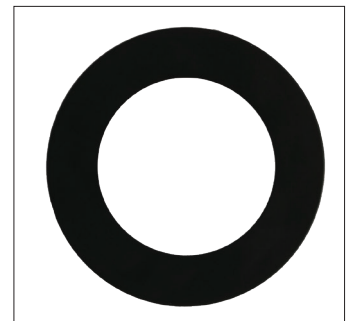

NOVADBLK

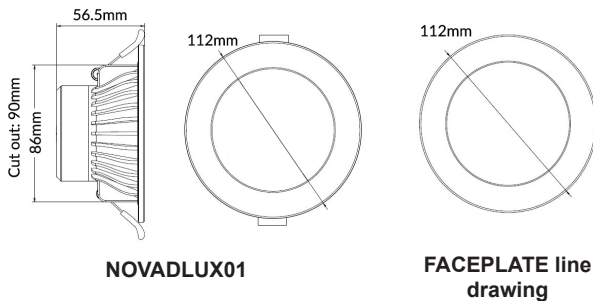

NOVADLUX01

FACEPLATE line drawing

PART NO.	DESCRIPTION	LUMENS			WATT	PRODUCT DIMENSIONS (mm)	CUT OUT (mm)	BOX WEIGHT (kg)	BOX DIMENSIONS (cm)	CARTON QTY
		3000K	4000K	5700K						
NOVADLUX01	D/L LED COB FIXED WH+S/C DIMM RND TRI	800lm	950lm	850lm	10	Ø112x56.5	Ø90	0.26	12x12x7	1/40
NOVADBLK	FACEPLATE TO SUIT NOVADLUX01 & NOVACOB01 MATT BLK OD 112mm									
NOVADBR	FACEPLATE TO SUIT NOVADLUX01 & NOVACOB01 ANTIQUE BRASS OD 112mm									