

GU10 EXTERIOR WALL PILLAR LIGHTS (WHITE)



Exterior Lighting



PGUDWH



PG1FWH



PG1AWH



PG2AWH

PRODUCT FEATURES

- Input voltage range: 110-265V AC 50/60Hz
- Material: aluminium
- Colour: powder coated white
- Max 35W halogen globe(s)
- Lamp holder: GU10 (Max.35W halogen globes)
- Globes not included

| | | |
|------|----------------------|---|
| GU10 | IP65 Rated | 2YEAR Replacement Warranty |
|------|----------------------|---|

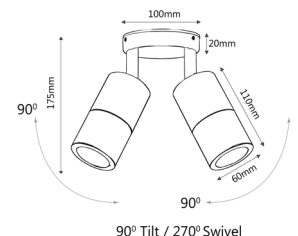
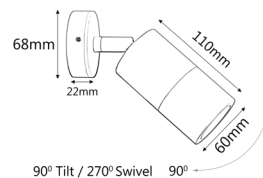
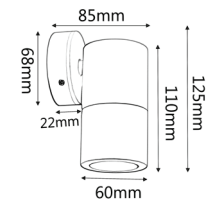
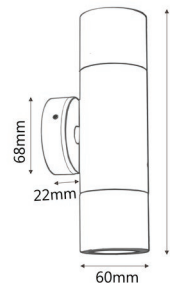

| PART NO. | DESCRIPTION | LAMP HOLDER | MAX. WATT | BACK PLATE (mm) | WEIGHT (KG) | BOX (CM) | CARTON QTY |
|---------------|--|-------------|-----------|-----------------|-------------|------------------|------------|
| PGUDWH | WALL GU10 X 2 PILLAR UP/DN WH | 2xGU10 | 2x35W | ø68x22 | 0.58 | 22.5 x 9.5 x 8.5 | 1/20 |
| PG1FWH | WALL GU10 PILLAR FIXED WH | 1xGU10 | 35W | ø68x22 | 0.40 | 15 x 10 x 8 | 1/20 |
| PG1AWH | WALL GU10 PILLAR S/ADJ WH 90D Tilt 270D | 1xGU10 | 35W | ø68x22 | 0.42 | 19.5 x 8 x 8 | 1/25 |
| PG2AWH | WALL GU10X2 PILLAR D/ADJ RND BASE WH 90D Tilt 270D | 2xGU10 | 2x35W | ø100x20 | 0.75 | 19 x 12 x 12 | 1/10 |

GU10 EXTERIOR BAR LIGHTS (White)



PG2BARWH



PG3BARWH



PG4BARWH



PG4SQWH

PRODUCT FEATURES

- Input voltage range: 110-265V AC 50/60Hz
- Material: aluminium
- Colour: powder coated white
- Lamp holder: GU10 (Max.35W halogen globes)
- Globes not included

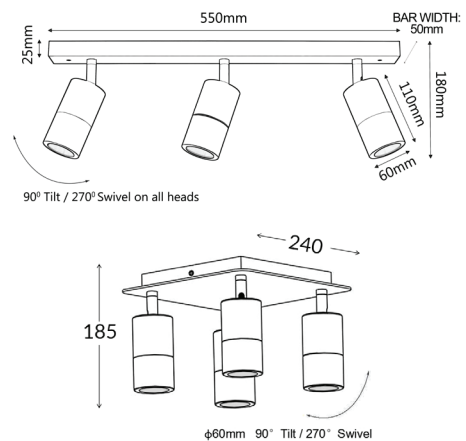
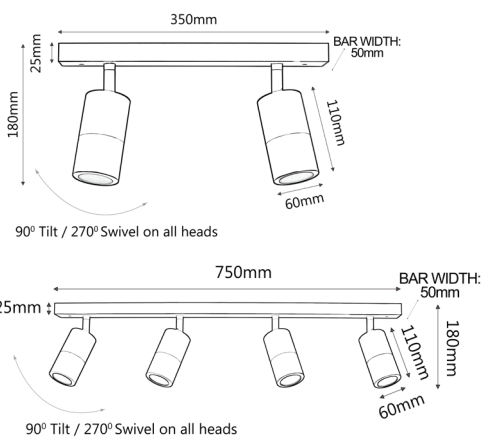

| PART NO. | DESCRIPTION | LAMP HOLDER | MAX. WATT | BACK PLATE(mm) | WEIGHT (KG) | LENGTH (CM) | CARTON QTY |
|----------|--|-------------|-----------|----------------|-------------|----------------|------------|
| PG2BARWH | WALL GU10 X 2 PILLAR D/ADJ BAR WH | 2xGU10 | 2x35W | 350x50x25 | 1.07 | 7.4x20.7x36.7 | 1/10 |
| PG3BARWH | WALL GU10 X 3 PILLAR 3 Light BAR WH | 3xGU10 | 3x35W | 550x50x25 | 1.53 | 7x20.5x56.5 | 1/10 |
| PG4BARWH | WALL GU10 X 4 PILLAR 4 LIGHT BAR WH | 4xGU10 | 4x35W | 750x50x25 | 2.00 | 7.5x20x76.5 | 1/10 |
| PG4SQWH | WALL GU10 X 4 PILLAR 4 Light BAR SQ WH | 4xGU10 | 4x35W | 240x240 | 2.03 | 26.5x26.5x21.5 | 1/4 |

MR16 EXTERIOR WALL PILLAR LIGHTS (WHITE)



PMUDWH



PM1FWH

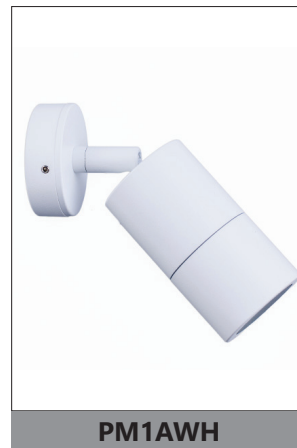

PM1AWH



PM2AWH

PRODUCT FEATURES

- Exterior surface mounted wall pillar spot lights
- Input voltage range: 12-24V
- Material: aluminium
- Colour: white
- Lamp holder: MR16 (Max.20W halogen)
- Globes not included
- Remote control gear required

IP65 Rated **2YEAR** Replacement Warranty

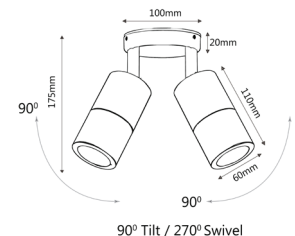
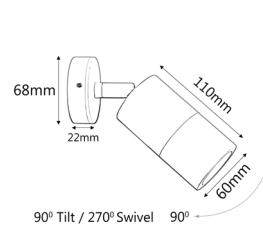
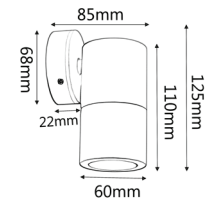
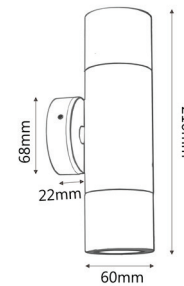

| PART NO. | DESCRIPTION | COLOUR | QTY OF GLOBES | WEIGHT (KG) | BOX (CM) | CARTON QTY |
|----------|--------------------------------|------------------|---------------|-------------|--------------|------------|
| PMUDWH | PILLAR MR16 UP/DN Aluminium WH | POWDER COATED WH | 2xMR16 | 0.58 | 8.5x9.5x22.5 | 25 |
| PM1FWH | PILLAR MR16 FIXED Aluminium WH | POWDER COATED WH | 1xMR16 | 0.39 | 8x10x14 | 25 |
| PM1AWH | PILLAR MR16 S/ADJ Aluminium WH | POWDER COATED WH | 1xMR16 | 0.42 | 8x8x19 | 25 |
| PM2AWH | PILLAR MR16 D/ADJ Aluminium WH | POWDER COATED WH | 2xMR16 | 0.80 | 12x12x19 | 10 |