



神牛微信公众号
Follow Wechat Public Account

合格证
QC PASS

深圳市神牛摄影器材有限公司

地址: 深圳市宝安区福海街道塘尾社区耀川工业区厂房2栋

电话: 0755-29609320(8062) 传真: 0755-25723423 邮箱: godox@godox.com

GODOX Photo Equipment Co., Ltd.

Add: Building 2, Yaochuan Industrial Zone, Tangwei Community, Fuhai Street, Bao'an District, Shenzhen, China Tel: +86-755-29609320(8062) Fax: +86-755-25723423

E-mail: godox@godox.com

godox.com

Made In China



Godox

WMicS1

说明手册
Instruction Manual

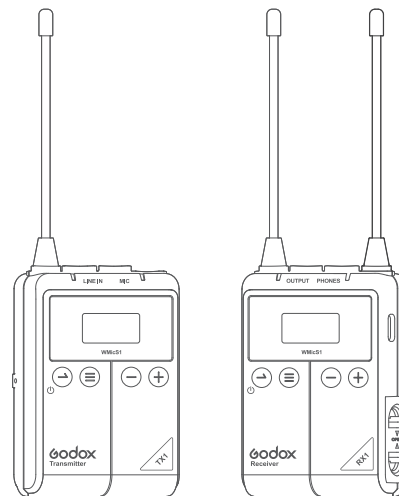

UHF无线麦克风系统

UHF Wireless Microphone system

前言

欢迎使用UHF无线麦克风系统——WMicS1，本产品非常适用于摄影录制，现场采访及语音录制等场合。请仔细阅读本产品说明书，以便能正确的操作，发挥本产品的优越性能。

产品特点

- UHF频率范围：514MHz-596MHz
- 96个无线频道可选，有效减少热频干扰
- 无线距离最大可达100m
- OLED显示屏提供各项参数设置
- 3.5mm耳机实时监听
- 输出音量控制，提供静音功能
- 发射功率可调节
- 一个接收器可同时连接两个发射器
- 两种供电方式

(注：最大支持频率为514MHz-596MHz，96个无线频道在此频率范围中选择，会存在部分频率没有利用的情况。)

警告

- ⚠ 请勿私自拆卸产品，如产品出现故障须由本公司或授权的维修人员进行检查维修。
- ⚠ 请保持干燥：请勿用湿手接触产品，亦不可将产品浸入水中或暴露于雨中。
- ⚠ 请勿让儿童接触本产品。
- ⚠ 请勿在易燃易爆环境中使用。在这些场合下，请注意相关警告标识。
- ⚠ 请勿放置在超过40度的高温环境中。
- ⚠ 若发生任何故障，请立即关闭电源。
- ⚠ 使用电池的注意事项：
 - 只能使用本手册中列出的电池。请勿混用新旧电池或不同类型的电池。
 - 请仔细阅读并遵守由厂商提供的警告或指示。
 - 切勿使电池短路或拆卸电池。
 - 切勿将电池投入火中或加热升温。
 - 切勿试图以反方向安装电池。
 - 当电量用尽时，电池容易漏液。所以为了避免产品受损，请在长期使用本产品或电量用尽时取出电池。
 - 如果受损电池中的液体接触到皮肤或衣服，请立即用大量清水冲洗。

部件名称

腰包发射器 (TX1)

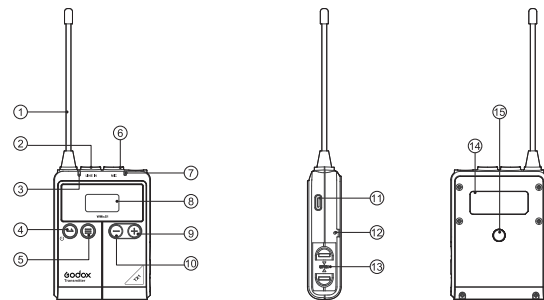

1. 天线
2. 3.5mm 音频线输入接口
3. Power 指示灯
 - 绿灯：电量充足
 - 红灯：电量低,需更换电池
4. 电源 / 静音键
5. 菜单键
6. 麦克风输入接口
7. Audio 指示灯
 - 绿灯：拾音模式
 - 红灯：静音模式
8. OLED 显示屏
9. 菜单 +
10. 菜单 -
11. USB Type-C
12. 金属背夹接口
13. 电池盒 - 两节 5号 电池
14. 产品标签贴
15. 1/4 冷靴接口

OLED显示屏：

1. 通讯频段
2. 无线组别及频道
3. 发射功率指标
4. 拾音 / 静音图标
5. 输入音量显示
6. 电池电量显示

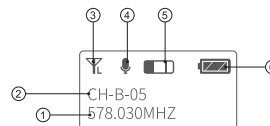

便携接收器 (RX1)

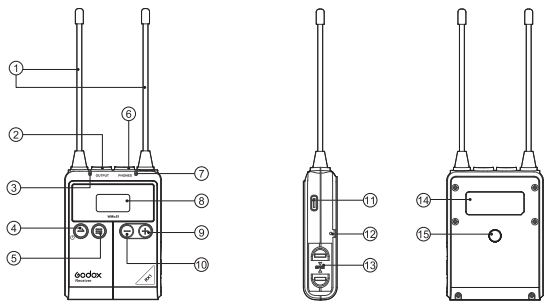

- | | | |
|------------------|------------------|--------------------|
| 1. 天线 | 6. 3.5mm 耳机监听接口 | 11. USB Type-C |
| 2. 3.5mm 音频线输出接口 | 7. RF 指示灯 | 12. 金属背夹接口 |
| 3. Power 指示灯 | - 绿灯: RF 信号强 | 13. 电池盒 - 两节 5 号电池 |
| - 绿灯: 电量充足 | - 红灯: RF 信号弱或已断开 | 14. 产品标签贴 |
| 4. 电源 / 返回键 | 8. OLED 显示屏 | 15. 1/4" 冷靴接口 |
| 5. 菜单键 | 9. 音量 + / 菜单 + | |
| | 10. 音量 - / 菜单 - | |

OLED显示屏:

- A 组射频信号
- B 组射频信号
- 电池电量显示
- A 组接收频道
- B 组接收频道
- 同步发射器电量及输入音量

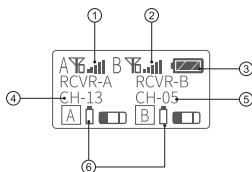

标配物品

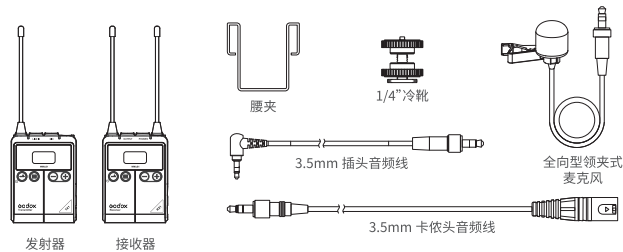

| 名称 | 型号 | 标配物品 |
|----------------|--------------|--|
| 腰包发射器 | TX1 | 发射器 x1 腰夹 x1 全向型领夹式麦克风 x1 |
| 便携接收器 | RX1 | 接收器 x1 腰夹 x1 3.5mm 插头音频线 x1 3.5mm 卡侬头音频线 x1 1/4" 冷靴 x1 |
| UHF 无线麦克风系统组合一 | WMicS1 Kit 1 | 发射器 x1 接收器 x1 腰夹 x2 全向型领夹式麦克风 x1 3.5mm 插头音频线 x1 3.5mm 卡侬头音频线 x1 1/4" 冷靴 x1 |
| UHF 无线麦克风系统组合二 | WMicS1 Kit 2 | 发射器 x2 接收器 x1 腰夹 x3 全向型领夹式麦克风 x2 3.5mm 插头音频线 x1 3.5mm 卡侬头音频线 x1 1/4" 冷靴 x1 |

可搭配产品



无线手持麦克风发射器
WH-M1



卡侬插槽发射器
TX3-XLR

供电方式

两种供电方式

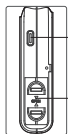

TYPE-C 接口 (5V)

两节 AA(5号) 干电池

使用说明

一、发射器设置

- ⊙ · 开机机：长按2秒电源开关按键即可开/关机；短按电源键开关静音。
- 三 · GRP/CH/RF设置：长按菜单键进入设置界面，再短按菜单键切换下一个设置。



- GRP组别设置：选中GRP，按+/-可选A/B组别。
- CH频道设置：选中CH，按+/-可设置CH，有01-48个频道可选择。
- RF功率设置：选中RF power切换H/L功率。



- 显示屏亮度设置：短按 +/- 至显示屏显示 OLED Light，再长按菜单键选中 OLED Light 对应的亮度级别。短按 +/- 键选择亮度级别，级别：1-8 八级。



- 软件版本：短按 +/- 显示Version时，表示软件的版本。



- 背光时间：短按 +/- 至显示屏显示 BackLight，再长按菜单键背光时间跳动，短按 +/- 键选择背光时间：ON 常亮, OFF 关闭, Delay10S/30S/60S。



- 恢复出厂设置：短按 +/- 至显示屏显示 Restore Default，再长按菜单键即可进行恢复出厂设置。



- 按键锁：在使用时需要进入按键误锁时，可以启用按键锁，在非设置状态下长按“+”进入锁定状态，再次长按“+”进行解锁。

二、接收器设置

- 开关机：长按 2 秒电源开关按键即可开 / 关机；
- RCVR/CH/VOL 设置：当需要设置 A 组别参数时，在显示 A 组别参数时长按菜单键进入设置界面，再短按菜单键切换下一个设置，需要设置 B 组别参数时，则需在显示 B 组别参数时长按菜单键进入设置界面。



- RCVR开关设置：选中RCVR，按+/-可选ON/OFF。
 - CH频道设置：选中CH，按+/-可设置CH，有01-48个频道可选择。
 - VOL 设置：选中VOL，按+/-可设置VOL，有00-30个音量可选择。
- 使用时，将接收器与发射器设置成相同的频道，即可录音和实时监听。



- 显示屏亮度设置：短按 +/- 至显示屏显示 OLED Light，再长按菜单键 OLED Light 对应的亮度值跳动，短按 +/- 键选择亮度级别，级别：1-8 八级。



- 输出模式：分为 Stereo（立体声）和 Mono（单声道）两种模式。短按 +/- 键切换至 Output mode，再长按菜单键即可进行两种声道切换。当输出模式是 Mono（单声道）时，左声道和右声道音频将被混合输出；当输出模式是 Stereo（立体声），左（A 组）和右（B 组）音频声道输出将独立；系统默认为 Mono（单声道）。



- 软件版本：短按 +/- 显示 Version 时，表示软件的版本。



- 背光时间：短按 +/- 至显示屏显示 BackLight，再长按菜单键背光时间跳动，短按 +/- 键选择背光时间：ON 常亮, OFF 常闭, Delay10S/30S/60S。



- 恢复出厂设置：短按 +/- 至显示屏显示 Restore Default，再长按菜单键即可进行恢复出厂设置。



- 按键锁：在使用时需要进入按键免误按时，可以启用按键锁，在非设置状态下长按“+”进入锁定状态，再次长按“+”进行解锁。

三、发射器接口：

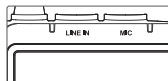

- LINE IN：连接外界音频信号输入。
- MIC：连接领夹麦克风。

四、接收器接口：

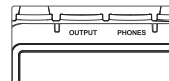

- OUTPUT：连接外界音频信号输出。
- PHONES：连接耳机线。

使用操作

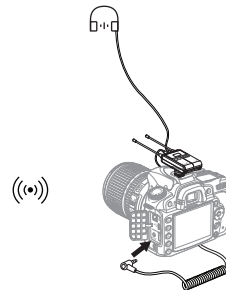

发射器

- ① 将全向型领夹式麦克风插入发射器的“MIC”接口；
- ② 打开发射器，设置相应参数；
- ③ 用腰夹将发射器夹在腰带上或可将发射器直接放进口袋里。

接收器

- ① 将 1/4"冷靴连接到接收器，并将其安装在相机 / 摄影设备上；
- ② 将 3.5mm 插头音频线的一端插入接收器的“OUTPUT”接口，另一端插入相机的“MIC”接口；
- ③ 打开接收器，设置相应参数。

注意：设置参数时，需将发射器与接收器设置相同的组别和频道；

一个接收器连接两个发射器使用时，必须A发射器设置在A组别使用，B发射器设置在B组别使用。

规格参数

| 名称 | 腰包发射器 TX1 | 便携接收器 RX1 |
|--------|-----------------|-----------------|
| 频道组 | A/B | A/B |
| 频道数 | 96(A组48; B组48) | 96(A组48; B组48) |
| RF频率范围 | 514MHz - 596MHz | 514MHz - 596MHz |
| 振荡器类型 | 晶体控制锁相环合成器 | 晶体控制锁相环合成器 |
| 音频频率范围 | 40Hz - 18KHz | 40Hz - 18KHz |
| 声音延迟 | 12ms | 12ms |
| 天线 | 1/4λ | 1/4λ |
| 音频输入接口 | 3.5mm接口 | 3.5mm接口 |
| 供电 | USB接口 | USB Type -C |
| | 电池 | 两节AA(5号)电池 |
| 工作温度范围 | 0°C-50°C | 0°C-50°C |
| 信噪比 | ≈70dB | ≈70dB |
| 接收灵敏度 | \ | -95dBm |
| 失真 | \ | 0.5%以下 |
| 尺寸 | 63*190*22mm | 63*190*25mm |
| 净重 | 70g | 80g |

故障排除

- 如不能接收到音频信号，请检查电池是否正确安装以及是否打开发射器电源；发射器和接收器是否设置在同一组别和频道；麦克风及耳机是否已正确牢固连接到位；功能模式是否设置正确。
- 检查发射器是否设置的静音。
- 如您的发射器受到他人干扰，改变发射器和接收器的频道设置即可。
- 如您发现发射音频距离有限或者有漏发现象，请检查是否电池耗尽，请尝试更换电池。

维护保养

避免跌落：如果受到强烈碰撞或振动，发射器和接收器可能会发生故障。

保持干燥：本产品是非防水产品，如果将其浸入水中或放置于高湿度的环境中将可能发生故障。内部构造生锈可能会导致无法修理的损害。

避免温度骤变：温度的突变，诸如在寒冷天进出温暖的大楼将可能会使发射器和接收器内部结露。为避免结露，请将发射器和接收器事先装入手提袋或塑料包内，以防温度突变。

远离强磁场：无线电广播发射机等设备产生的强静电或强磁场可能会干扰本产品正常工作。1 年保修，消耗品如领夹麦克风等，不在 1 年保修范围。

经发现擅自检修此设备，将取消一年保修期，维修需要收取相关费用。

如果本品出现故障或者被水淋湿，在专业人员维修后方可继续使用。

如有技术更改，恕不另行通知。

产品保修

尊敬的用户，本保修卡是申请保修服务的重要凭证，请您配合销售商填写并妥善保管，谢谢！

| | | |
|-------|------|------|
| 产品信息 | 型号 | 产品条码 |
| 用户信息 | 姓名 | 联系电话 |
| | 通信地址 | |
| 销售商信息 | 名称 | |
| | 联系电话 | |
| | 通信地址 | |
| | 销售日期 | |
| 备注 | | |

注：此表应由销售商盖章确认。

产品信息

本文件适用于相关《产品保修信息》(见后面说明)所列产品，其他非属此范围的产品或部件(如促销品、赠品及其他出厂后附加的部件等)不在此保修承诺内。

保修期

产品及部件的相应保修期按相关的《产品保修信息》执行。保修期自产品首次购买日起算，购买日以购买产品时保修卡登记日期为准。

如何获得保修服务

要保修服务，您可直接与产品销售商或授权服务机构联系，也可拨打神牛产品售后服务电话，与我们联系，由我们的服务人员为您安排服务。申请保修时，您应提供有效的保修卡作为保修凭证，方可获得保修。如您不能提供有效的保修卡，则在我们可确认产品或部件属于保修范围的情况下，也可以为您提供保修，但这不作为我们的义务。

不适用保修的情况

如产品存在下列情况，本文件项下的保证和服务将不适用 ① 产品或部件超过相应保修期；② 错误或不适当使用、维护或保管导致的故障或损坏，如：不当搬运；非按产品合理预期用途使用；不当插拔外接设备；跌落或外力挤压；接触或暴露于不适当温度、溶剂、酸碱、水浸或潮湿环境；③ 由非神牛授权机构或人员安装、修理、更改、添加或拆卸造成的故障或损坏；④ 产品或部件原有识别信息被修改变更或删除；⑤ 无有效保修卡；⑥ 使用非法授权、非标准或非公开发行的软件造成的故障或损坏；⑦ 因不可抗力或意外事件造成的故障或损坏；⑧ 其他非因产品本身质量问题导致的故障或损坏。遇上述情况，您应向相关责任方寻求解决，神牛对此不承担任何责任。因非在保修期或保修范围内的部件、附件或软件导致产品不能正常使用的，不是保修范围内的故障。产品使用过程中正常的脱色，磨损和消耗，不是保修范围内的故障。

产品保修和服务支持信息

产品的保修期和服务类型按以下《产品保修信息》执行：

| 产品类别 | 选件名称 | 保修期(月) | 保修服务类型 |
|------|--|--------|--------|
| 部件 | 电路板 | 12 | 客户送修 |
| | 电池 | 3 | 客户送修 |
| | 充电器、电源线，同步线等带电性能的部件 | 12 | 客户送修 |
| 其他 | 如电池盒、防风棉、防风毛罩、锁紧装置、手提绳、扎带、魔术贴、领夹、便携袋、包装等 | 无 | 无保修 |

神牛产品售后服务电话 0755-29609320-8062

Forward

Thank you for purchasing **UHF Wireless Microphone system-WMicS1**. These products are suitable for video recording, journalistic shooting, audio recording, etc. Please read this manual carefully before using to make sure the correct operation and exert the optimum function.

Features:

- UHF Frequency Range: 514MHz-596MHz
 - There are 96 wireless channels which can be freely switched without interference
 - High and stable sound quality like broadcast
 - The maximum wireless distance up to 100m
 - With OLED display to show the parameters setting
 - Achieve real-time monitoring with 3.5mm earphone
 - With output volume control and silence function
 - The power of transmitter is adjustable
 - Support two transmitters and one receiver to work simultaneously
 - Two power supply mode
- (Note: as the max. support frequency is 514MHz-596MHz which includes the 96 wireless channel's frequency, there are parts of frequency may not be utilized.)

Warning

- ⚠ **Do not disassemble. Should repairs become necessary, this product must be sent to an authorized maintenance center.**
- ⚠ **Always keep this product dry. Do not use in rain or in damp conditions.**
- ⚠ **Keep out of reach of children.**
- ⚠ **Do not use this product in the presence of flammable gas. In certain circumstance, please pay attention to the relevant warnings.**
- ⚠ **Do not leave or store the product if the ambient temperature reads over 40°C.**
- ⚠ **Turn off this product immediately in the event of malfunction.**
- ⚠ **Observe precautions when handling batteries.**
 - Use only batteries listed in this manual. Do not use old and new batteries or batteries of different types at the same time.
 - Read and follow all warnings and instructions provided by the manufacturer.
 - Batteries cannot be short-circuited or disassembled.
 - Do not put batteries into a fire or apply direct heat to them.
 - Do not attempt to insert batteries upside down or backwards.
 - Batteries are prone to leakage when fully discharged. To avoid damage to the product, be sure to remove batteries when the product is not used for a long time or when batteries run out of charge.
 - Should liquid from the batteries come into contact with skin or clothing, rinse immediately with fresh water.

Names of Parts

Body-pack Transmitter (TX1)

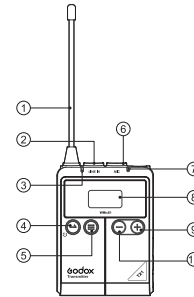

1. Antenna
2. 3.5mm Audio Line In Port
3. Power Indicator
 - Green light: full battery level
 - Red light: Low battery level, replace the batteries
4. Power Source/Mute Button
5. Menu Button

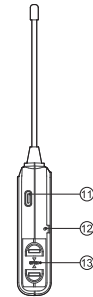

6. Microphone Input Port
7. Audio Indicator
 - Green light: Sound directivity mode
 - Red light: Silent mode
8. OLED Display
9. Menu +
10. Menu -

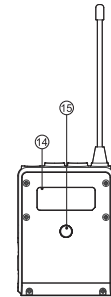

11. USB Type-C Port
12. Metal Clip Port
13. Battery Holder
 - 2×AA Battery
14. Product Label
15. 1/4" Shoe Mount Port

OLED Display :

1. Communication Frequency
2. Wireless Group and Channel
3. Transmitting Power Icon
4. Pick-up Sound/Silent Icon
5. Input Volume Indicator
6. Battery Level Indicator

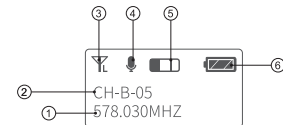

Portable Receiver (RX1)

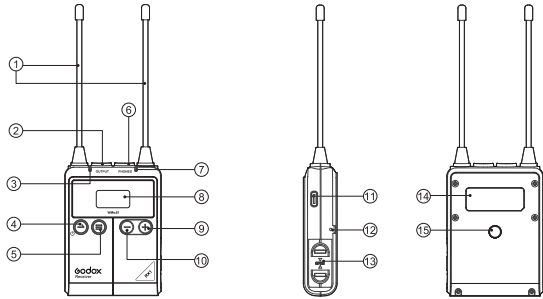

1. Antenna
2. 3.5mm Audio Output Port
3. Power Indicator
-Green light: full battery level
-Red light: Low battery level, replace the batteries
4. Power Source/Return Button
5. Menu Button
6. 3.5mm Earphone Monitoring Port
7. RF Indicator
-Green light: Strong RF signal
-Red light: Weak or disconnected RF signal
8. OLED Display
9. Volume +/Menu +
10. Volume -/Menu -
11. USB Type-C Port
12. Metal Clip Port
13. Battery Holder
-2×AA Battery
14. Product Label
15. 1/4"Shoe Mount Port

OLED Display:

1. A Group Frequency Signal
2. B Group Frequency Signal
3. Battery Level Indicator
4. A Group Receive Channel
5. B Group Receive Channel
6. Transmitter's Battery Level and Volume

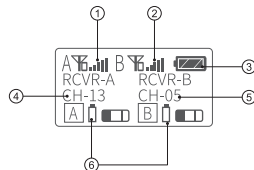

Included Item

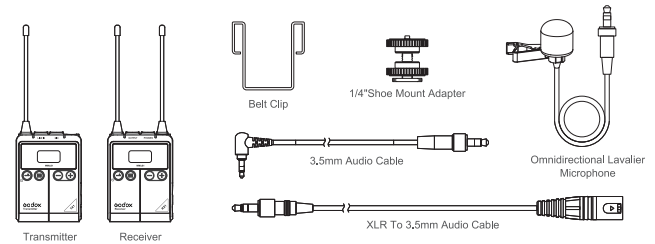

| Name | Model | Included Items |
|--------------------------------------|--------------|---|
| Body-pack Transmitter | TX1 | Transmitter x1 Belt Clip x1 Omnidirectional Lavalier Microphone x1 |
| Portable Receiver | RX1 | Receiver x1 Belt Clip x1 3.5mm Audio Cable x1 XLR To 3.5mm Audio Cable x1 1/4"Shoe Mount Adapter x1 |
| UHF Wireless Microphone System Kit 1 | WMicS1 Kit 1 | Transmitter x1 Receiver x1 Omnidirectional Lavalier Microphone x1 Belt Clip x2 3.5mm Audio Cable x1 XLR To 3.5mm Audio Cable x1 1/4"Shoe Mount Adapter x1 |
| UHF Wireless Microphone System Kit 2 | WMicS1 Kit 2 | Transmitter x2 Receiver x1 Omnidirectional Lavalier Microphone x2 Belt Clip x3 3.5mm Audio Cable x1 XLR To 3.5mm Audio Cable x1 1/4"Shoe Mount Adapter x1 |

Recommended Combination



Wireless Handheld Microphone
Transmitter WH-M1



Plug-On XLR Transmitter TX3-XLR

Power Supply

There are two modes of power supply

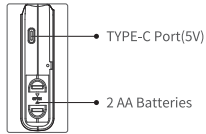

Operation Instruction

Transmitter Setting

- Ⓞ • Power on/off: Long press the power switch for 2 seconds to power it on or off. Short press the power switch to make it silent.
- ☰ • GRP/CH/RF Setting: Long press the menu button to enter the setting interface. Then, short press the menu button to switch the next setting.

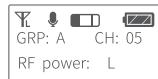

- GRP Group setting: choose GRP and press +/- to choose A or B group.
- CH Channel setting: choose CH and press +/- to set channel from 01 to 48.
- RF Power setting: choose RF power to switch H/L power.



- Display brightness setting: short press +/- button until OLED light is displayed on the panel. Then, long press the menu button to choose the corresponding brightness level of OLED light. Short press +/- button to choose brightness from 1 to 8 levels.



- Software version: short press +/- button until Version is displayed, which means the version of software.



- Backlighting time: Short press +/- until Back Light is displayed on the LCD panel. Then, long press the menu button and the backlighting time will be blinking. Short press the +/- button to choose backlighting time: ON means lighting and OFF means off. Delay 10S/30S/60S.



- Restore factory settings: short press the +/- button until Restore Default is displayed. Then, long press the menu button to restore factory settings.



- Button lock: To avoid pressing down mistakenly, it is recommended to use the button lock. Long press the "+" to enter the locking state and long press it again to unlock.

Receiver Setting

- ⓘ • Power On/Off: long press the button for 2 seconds to power it on or off.
- ☰ • RCVR/CH/VOL setting: to set channel A's parameters, long press the menu button to enter setting interface during the A's parameters are displayed. Then, short press the menu button to switch to the next setting. To set channel B's parameters, long press the menu button to enter setting interface during the B's parameters are displayed.



- RCVR Power switch setting: select RCVR and press +/- button to choose ON/OFF.
 - CH Channel setting: select CH and press +/- button to choose channel from 01 to 48.
 - VOL Setting: select VOL and press +/- button to choose volume from 00 to 30.
- Please set the receiver and transmitter to the same channel during usage, thus achieving recording and real-time monitoring.



- Display brightness setting: short press +/- button until OLED light is displayed on the panel. Then, long press the menu button and the corresponding brightness value of OLED light will be blinking. Short press +/- button to choose brightness from 1 to 8 levels.



- Output mode: there are Stereo mode and Mono mode. Short press +/- button to enter output mode. Then, long press the menu button to switch the two channels. When in Monochannel output, the sound of left channel and right channel will be output simultaneously. When in Stereo channel output, the sound of left channel(A group) and right channel(B group) will be output independently. The default channel of this system is Mono channel.



- Software version: short press +/- button until Version is displayed, which means the version of software.



- Backlighting time: Short press +/- until Back Light is displayed on the LCD panel. Then, long press the menu button and the backlighting time will be blinking. Short press the +/- button to choose backlighting time: ON means lighting and OFF means off. Delay 10S/30S/60S.



- Restore factory settings: short press the +/- button until Restore Default is displayed. Then, long press the menu button to restore factory settings.



- Button lock: To avoid pressing down mistakenly, it is recommended to use the button lock. Long press the "+" to enter the locking state and long press it again to unlock.

Transmitter Port

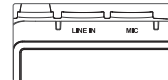

- LINE IN: to connect with external audio signal input.
- MIC: to connect with lavalier microphone.

Receiver Port

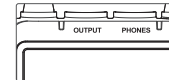

- OUTPUT: to connect with external audio signal output.
- PHONES: to connect with earphone cable.

Operation

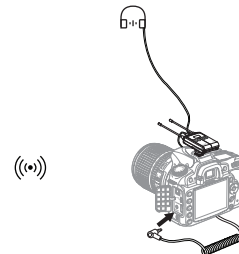
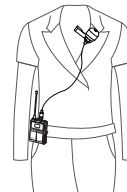

Transmitter

- ① Insert the omnidirectional lavalier microphone into the transmitter's MIC port.
- ② Turn on the transmitter to set the relevant parameters.
- ③ Clip the transmitter onto the belt or put it into your pocket.

Receiver

- ① Connect the 1/4" cold shoe onto the receiver, and install them on the camera or shooting equipment.
- ② Insert one end of the 3.5mm cable into the receiver's OUTPUT port and the other end into camera's MIC port.
- ③ Turn on the receiver to set relevant parameters.

Note: Please set the group and channels of transmitter and receiver to the same when setting parameters.

When a receiver is connecting to two transmitters, A transmitter must be set and used in A group while B transmitter must be set and used in B group.

Technical Data

| | | |
|---------------------------|------------------------------------|------------------------------------|
| Name | Body-pack Transmitter TX1 | Portable Receiver RX1 |
| Channel Group | A/B | A/B |
| Selectable Channel | 96(Group A: 48; Group B: 48) | 96(Group A: 48; Group B: 48) |
| RF Frequency Range | 514MHz - 596MHz | 514MHz - 596MHz |
| Oscillator Type | Crystal Controlled PLL Synthesizer | Crystal Controlled PLL Synthesizer |
| Audio Frequency Range | 40Hz-18KHz | 40Hz-18KHz |
| Sound Delay | 12ms | 12ms |
| Antenna | 1/4λ | 1/4λ |
| Audio Input Port | 3.5mm Port | 3.5mm Port |
| Power Supply | USB Port | USB Type-C |
| | Battery | Two AA batteries |
| Working Temperature Range | 0°C-50°C | 0°C-50°C |
| Signal Noise Ratio | ≈70dB | ≈70dB |
| Receive Sensitivity | \ | -95dBm |
| Distortion | \ | Below 0.5% |
| Size | 63*190*22mm | 63*190*25mm |
| Net Weight | 70g | 80g |

Troubleshooting

- Unable to receive audio signal. Make sure batteries are installed correctly and Power Switch is turned on. Check if the transmitter and the receiver are set to the same channel, if the microphone or earphone is well connected, or if the devices are set to the correct mode.
- Check if the transmitter is set to silent mode or not. Signal disturbance or shooting interference. Change a different channel of the transmitter and receiver.
- Operating audio distance limited or signal missing. Check if batteries are exhausted. If so, replace them.

Maintenance

Avoid sudden drops. The device may fail to work after strong shocks, impacts, or excess stress.

Keep dry. The product isn't water-proof. Malfunction, rust, and corrosion may occur and go beyond repair if soaked in water or exposed to high humidity.

Avoid sudden temperature changes. Condensation happens if sudden temperature changes such as the circumstance when taking the transmitter and receiver out of a building with higher temperature to outside in winter. Please put the transmitter and receiver in a handbag or plastic bag beforehand.

Keep away from strong magnetic field. The strong static or magnetic field produced by devices such as radio transmitters leads to malfunction. This product, except consumables e.g. lapel microphone, is supported with a one-year warranty.

Unauthorized service will void the warranty.

If the product had failures or was wetted, do not use it until it is repaired by professionals. Changes made to the specifications or designs may not be reflected in this manual.

FCC statement:

This equipment complies with FCC radiation exposure limits set forth for an uncontrolled environment. a.This device complies with part 15 of the FCC Rules. Operation is subject to the following two conditions: (1) This device may not cause harmful interference, and (2) this device must accept any interference received, including interference that may cause undesired operation. b.Warning: Changes or modifications to this unit not expressly approved by the part responsible for compliance could void the user's authority to operate the equipment. c.NOTE: This equipment has been tested and found to comply with the

limits for a Class B digital device, pursuant to part 15 of the FCC Rules. These limits are designed to provide reasonable protection against harmful interference in a residential installation. This equipment generates, uses and can radiate radio frequency energy and, if not installed and used in accordance with the instructions, may cause harmful interference to radio communications. However, there is no guarantee that interference will not occur in a particular installation. If this equipment does cause harmful interference to radio or television reception, which can be determined by turning the equipment off and on, the user is encouraged to try to correct the interference by one or more of the following measures: —Reorient or relocate the receiving antenna. —Increase the separation between the equipment and receiver. —Connect the equipment into an outlet on a circuit different from that to which the receiver is connected. —Consult the dealer or an experienced radio/TV technician for help.

Warranty

Dear customers, as this warranty card is an important certificate to apply for our maintenance service, please fill in the following form in coordination with the seller and safe-keep it. Thank you!

| | | |
|-----------------------------|-----------------------|----------------------------|
| Product Information | Model | Product Code Number |
| Customer Information | Name | Contact Number |
| | Address | |
| Seller Information | Name | |
| | Contact Number | |
| | Address | |
| | Date of Sale | |
| Note | | |

Note: This form shall be sealed by the seller.

Applicable Products

The document applies to the products listed on the Product Maintenance Information (see below for further information). Other products or accessories (e.g. promotional items, giveaways and additional accessories attached, etc.) are not included in this warranty scope.

Warranty Period

The warranty period of products and accessories is implemented according to the relevant Product Maintenance Information. The warranty period is calculated from the day (purchase date) when the product is bought for the first time, and the purchase date is considered as the date registered on the warranty card when buying the product.

How to Get the Maintenance Service

If maintenance service is needed, you can directly contact the product distributor or authorized service institutions. You can also contact the Godox after-sale service call and we will offer you service. When applying for maintenance service, you should provide valid warranty card. If you cannot provide valid warranty card, we may offer you maintenance service once confirmed that the product or accessory is involved in the maintenance scope, but that shall not be considered as our obligation.

Inapplicable Cases

The guarantee and service offered by this document are not applicable in the following cases: ①. The product or accessory has expired its warranty period; ②. Breakage or damage caused by inappropriate usage, maintenance or preservation, such as improper packing, improper usage, improper plugging in/out external equipment, falling off or squeezing by external force, contacting or exposing to the improper temperature, solvent, acid, base, flooding and damp environments, etc; ③. Breakage or damage caused by non-authorized institution or staff in the process of installation, maintenance, alternation, addition and detachment; ④. The original identifying information of product or accessory is modified, alternated, or removed; ⑤. No valid warranty card; ⑥. Breakage or damage caused by using illegally authorized, nonstandard or non-public released software; ⑦. Breakage or damage caused by force majeure or accident; ⑧. Breakage or damage that could not be attributed to the product itself. Once met these situations above, you should seek solutions from the related responsible parties and Godox assumes no responsibility. The damage caused by parts, accessories and software that beyond the warranty period or scope is not included in our maintenance scope. The normal discoloration, abrasion and consumption are not the breakage within the maintenance scope.

Maintenance and Service Support Information

The warranty period and service types of products are implemented according to the following **Product Maintenance Information**:

| Product Type | Name | Maintenance Period(month) | Warranty Service Type |
|--------------|---|---------------------------|---|
| Parts | Product Main Body | 12 | Customer sends the product to designated site |
| | Battery | 3 | Customer sends the product to designated site |
| | Charger, Power Cable, Sync Cable, Electrical Parts etc. | 12 | Customer sends the product to designated site |
| Other Items | Battery Case, Windscreen Foam, Wind Cap, Locking Device, Lanyard, Tie, Velcro Tape, Clip, Bag, Package etc. | No | Without warranty |

Godox After-sale Service Call 0755-29609320-8062