

Godox 神牛

迅丽机顶闪光灯  
Thinklite Camera Flash  
TT600



INSTRUCTION MANUAL

说 明 手 册

中英文双语 / Chinese English Bilingual

**在使用本产品之前：**

请先仔细阅读本手册，以确保您能安全使用。请保存好本手册以备将来查询参考。

**Before using this product:**

Please read this user manual carefully in order to ensure your safety and the proper operation of this product. Keep for future reference.

## Foreword

### **Thank you for purchasing a GODOX product.**

TT600 camera flash adopts Godox wireless X system and 2.4G radio transmission, which is compatible with AD360II-C、AD360II-N、TT685C、TT685N、X1T-C、X1T-N, etc. Fit all DSLR camera brands e.g. Canon, Nikon, Sony, etc.

### **This TT600 camera flash features:**

- GN60 (m ISO 100, @200mm). Adjust from 1/1 to 1/128 in 1/3rd stops
- Built-in 2.4G wireless transmission to support transmitting and receiving
- High speed sync, wireless remote control, multi flash and manual focus assist
- Stable consistency and color temperature with good even lighting
- User-friendly LCD display & control panel

## **⚠ Warning**

- ⚠ Always keep this product dry. Do not use in rain or in damp conditions.
- ⚠ Do not disassemble. Should repairs become necessary, this product must be sent to an authorized maintenance center.
- ⚠ Keep out of reach of children.
- ⚠ Stop using this product if it breaks open due to extrusion, falling or strong hit. Otherwise, electric shock may occur if you touch the electronic parts inside it.
- ⚠ Do not fire the flash directly into the eyes (especially those of babies) within short distances. Otherwise visual impairment may occur.
- ⚠ Do not use the flash unit in the presence of flammable gases, chemicals and other similar materials. In certain circumstance, these materials may be sensitive to the strong light emitting from this flash unit and fire or electromagnetic interference may result.
- ⚠ Do not leave or store the flash unit if the ambient temperature reads over 50°C . Otherwise the electronic parts may be damaged.
- ⚠ Turn off the flash unit immediately in the event of malfunction.



## Thinklite Camera Flash

### Conventions used in this Manual

- This manual is based on the assumption that both the camera and camera flash's power switches are powered on.
- Reference page numbers are indicated by "p.\*\*".
- The following alert symbols are used in this manual:
  - ▲ The Caution symbol gives supplemental information.
  - The Note symbol indicates a warning to prevent shooting problem.

# Contents

19	Foreword
20	Warning
23	Name of Parts
	Body
	Control Panel
	LCD Panel
	What's in the Box of TT600?
	Separately Sold Accessories
26	Attaching to a Camera
26	Using the Flash
	Power Management
	Flash Output
	ZOOM: Setting the Flash Coverage
	M Mode
	Multi Mode: Stroboscopic Flash
	S1 Mode
	S2 Mode
	 Hi-Speed Sync Triggering
	Custom Function----Focus Assist Beam
	Buzz Function
	Wireless Flash Shooting: Ratio (2.4G)
	Transmission
	Wireless Control Function
	Sync Triggering
	Custom Function----Sleep Function
	C.Fn Setting Custom Functions
34	Protection Function
35	Advanced Application
37	Technical Data
37	Maintenance

## Name of Parts

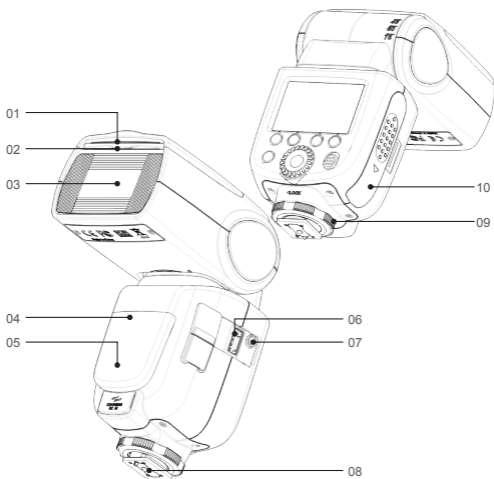

### • Body

- |  |                           |
|--|---------------------------|
| 01. Catchlight Panel                   | 06. Wireless Control Port |
| 02. Built-In Wide Panel<br>(Retracted) | 07. Sync Cord Jack        |
| 03. Flash Head                         | 08. Hotshoe               |
| 04. Optic Control Sensor               | 09. Lock Ring             |
| 05. Focus Assist Beam                  | 10. Battery Compartment   |

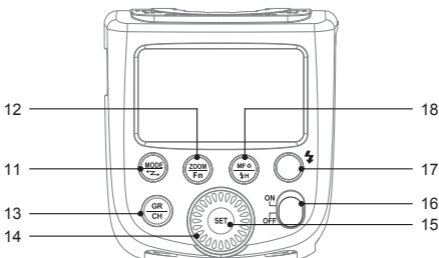

### • Control Panel

- |   |   |
|---|---|
| 11.  Mode Selection Button/<br>Wireless Mode Selection<br>(Long Keypress) | 15.  Set Button   |
| 12.  Zoom / Function Custom<br>Button (Long Keypress)                     | 16. ON/OFF Power Switch   |
| 13.  Group/ Channel Setting<br>(Long Keypress)                            | 17.  Test Button / Flash<br>Ready Indicator                           |
| 14.  Select Dial  | 18.  Focus Assist Beam /<br>High Speed Sync Button<br>(Long Keypress) |

## Name of Parts

### ● LCD Panel

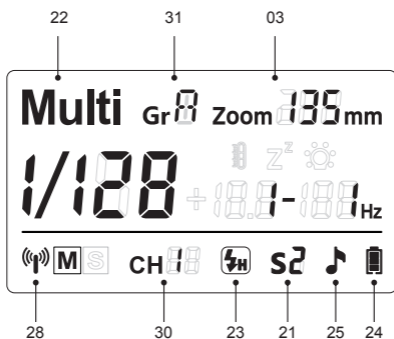
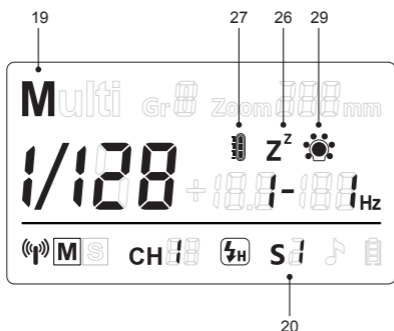

- |  |                                     |
|--|-------------------------------------|
| 19. <M>Manual Flash Mode                 | 26. <Z <sup>z</sup> >Sleep Status   |
| 20. <S1>S1 Slave Flash Triggering        | 27. <🔥>Overtemperature Indication   |
| 21. <S2>S2 Slave Flash Triggering        | 28. <📶>Wireless Signal Transmission |
| 22. <Multi>Multi/Stroboscopic Flash Mode | 29. <🔦>Focus Assist Beam Indicator  |
| 23. <⚡H>High Speed Sync Triggering       | 30. Channel                         |
| 24. <🔋> Battery Level Indication         | 31. Group                           |
| 25. <🎵> Sound Beep Indication            |                                     |

## ● What's in the Box of TT600?

1. Flash unit
2. Mini stand
3. Protection case
4. Instruction manual



## ● Separately Sold Accessories

The product can be used in combination with the following accessories sold separately, so as to achieve best photography effects: **Cells II high speed trigger, FT-16S power & trigger control, Car charger, Mini softbox, White & Silver Reflector, Honeycomb, Color gels, Snoot, etc.**





## Attaching to a Camera

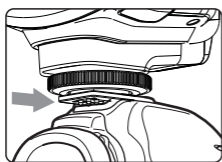

- 1 Attach the Camera Flash.**
- Slip the camera flash's mounting foot into the camera's hotshoe all the way.

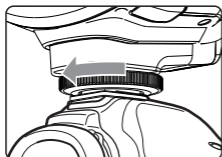

- 2 Secure the Camera Flash.**
- Rotate the locking screw on the mounting foot until it locks up.

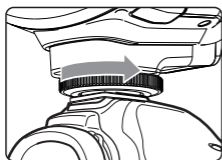

- 3 Detach the Camera Flash.**
- Rotate the locking screw on the mounting foot until it is loosened.

## Using the Flash

### 1. Power Management

Use ON/OFF Power Switch to power the flash unit on or off. Turn off if it will not be used for an extended period of time. This flash unit has Sleep Function and will enter into sleep status when there is no operation for a long time. For Sleep Function setting, see the following instruction.

### 2. Flash Output

- Flash output can be varied from 1/128th power to 1/1 full power in 1/3 stop increments. To obtain a correct flash exposure, use a hand-held flash meter to determine the required flash output.
- Adjust the power output by rotating Select Dial . The following table makes it easier to see how the stop changes in terms off/stop when you increase or decrease the flash output:

Figures displayed when reducing flash output level ➡

1/1	1/1-0.3	1/1-0.7	1/2	1/2-0.3	1/2-0.7	1/4	...	OF
	1/2+0.7	1/2+0.3		1/4+0.7	1/4+0.3		...	

← Figures displayed when increasing flash output level

- ▲** When "OF" is shown on the LCD display, it means no flash output and flash firing is turned off.

### 3. ZOOM: Setting the Flash Coverage

The flash coverage can be set to match the lens focal length from 24 mm to 200 mm. Press  button and rotate Select Dial  to change the flash coverage.

- ▲** When setting the flash coverage, make sure it covers the lens focal length so that the picture will not have a dark periphery.

## Using the Flash

### 4. M Mode: Manual Mode

Press MODE Selection Button  to enter M mode. In this mode, you can set the flash unit onto your camera hot shoe or your trigger hot shoe for firing. Before shooting, adjust the flash power output. When the camera's shutter is pressed, the flash will fire synchronously. Slave triggering mode is not available in M mode.

### 5. Multi Mode: Stroboscopic Flash

Press Mode Selection Button  to enter Multi mode (Stroboscopic flash). With stroboscopic flash, a rapid series of flashes is fired. It can be used to capture multiple images of a moving subject in a single photograph. You can set the firing frequency (number of flashes per sec. expressed as Hz), the number of flashes, and the flash output. For setting procedures, see the following:

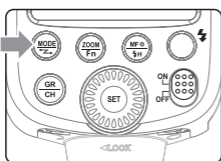

**1** Press the Mode Selection Button  so that "Multi" is displayed.

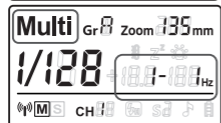

**2** Press Set Button  to select the item to be set. The item blinks.

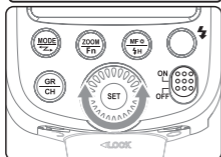

**3** Rotate Select Dial  to set a desired number.

### Calculating the Shutter Speed

During stroboscopic flash, the shutter remains open until the firing stops. Use the provided formula to calculate the shutter speed required to capture the full sequence of flashes:

$$\text{Number of flashes} / \text{Firing frequency} = \text{Shutter speed}$$

For example, if the number of flashes is 10 and the firing frequency is 5 Hz, the shutter speed should be at least 2 sec.

#### Note:

- Stroboscopic flash is most effective with a highly reflective subject against a dark background.
- Using a tripod and a remote switch is recommended.
- A flash output of 1/1 or 1/2 cannot be set for stroboscopic flash.
- Stroboscopic flash can be used with "buLb".

# Using the Flash

## Maximum Stroboscopic Flashes :

Flash Output \ Hz	1	2	3	4	5	6-7	8-9
1/4	7	6	5	4	4	3	3
1/8	14	14	12	10	8	6	5
1/16	30	30	30	20	20	20	10
1/32	60	60	60	50	50	40	30
1/64	90	90	90	80	80	70	60
1/128	100	100	100	100	100	90	80

Flash Output \ Hz	10	11	12-14	15-19	20-50	60-199
1/4	2	2	2	2	2	2
1/8	4	4	4	4	4	4
1/16	8	8	8	8	8	8
1/32	20	20	20	18	16	12
1/64	50	40	40	35	30	20
1/128	70	70	60	50	40	40

**⚠** To avoid overheating and deteriorating the flash head during stroboscopic flash, do not use stroboscopic flash more than 10 times in succession.

## 6. S1 Mode: S1 Slave Triggering Mode

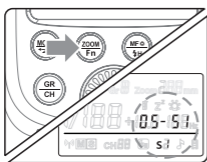

- Long Press <ZOOM Fn> button for 2 seconds to enter the custom menu and press <SET> Button to choose OS. Then, turn the Select Dial to choose OFF/S1/S2.
- In S1 mode, the flash unit can function as a slave flash for creating multiple lighting effects. It is respectively applicable to manual flash environment.
- In S1 mode, the flash unit will fire synchronously when the master flash fires, the same effect as that by the use of radio triggers.

## 7. S2 Mode: S2 Slave Triggering Mode

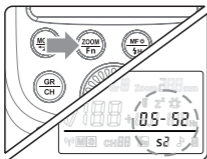





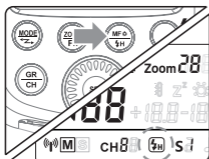

- Long Press <ZOOM Fn> button for 2 seconds to enter the custom menu and press <SET> Button to choose OS. Then, turn the Select Dial to choose OFF/S1/S2.

## Using the Flash

- In S2 mode, the flash unit can function as a slave flash for creating multiple lighting effects. It is applicable when using a TTL master flash.
- In S2 mode, the flash unit will ignore a single “preflash” from the master flash and will only fire in response to the second, actual flash from the master.

### 8. Hi-Speed Sync Triggering



- To enter  mode, long press  button and hold for 2 seconds.
- To exit  mode, press Mode Selection Button or long press  button and hold for 2 seconds again.
- In  hi-speed sync triggering mode, you can use a hi-speed sync trigger to have your flash unit synchronized with all shutter speeds of cameras (max. 1/8000 second, up to your camera). This is convenient when you want to use aperture priority for fill-flash portraits.

#### Note:

\*Hi-speed sync triggering mode is effective only when the flash unit is used together with the following flash triggers.

1. Hi-speed sync trigger, e.g., Godox Cells II transceiver.
2. TTL wireless flash trigger X1C
3. TTL wireless flash trigger X1N

\*Hi-speed sync triggering mode is not available when TT600 is mounted onto the camera.



Godox Cells II transceiver  
(Optional)



TTL wireless flash trigger  
X1C /X1N (Optional)

-  To avoid overheating or deteriorating the flash head during high speed sync flash, the over-temperature protection function will be activated automatically after 10 continuous high-speed flashes and the recycle time becomes 10 seconds longer.

# Using the Flash

## 9. Custom Function--Focus Assist Lamp

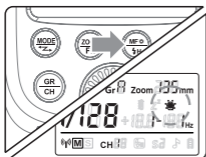

- Under poorly-lit or low-contrast conditions, you can press button to turn on the focus assist beam in order to make it easier to autofocus.
- The beam will automatically put out certain seconds after the last pop is fired. The time between the last fire and the auto shutdown of focus assist beam is called No-Flash Time. The time is user adjustable and set to 10 seconds by default.
- Press button and hold for 2 seconds to enter Custom Function. Then press "SET" button to enter "FC" mode. The LCD panel displays "FC" (Auto shutdown of focus assist lamp) and "No-Flash Time". Rotate Select Dial to set a desired time for the flash. Press button to return.

No-Flash Time	Meaning
10 seconds	10 seconds after the last fire, focus assist lamp will automatically get out.
20 seconds	20 seconds after the last fire, focus assist lamp will automatically get out.
30 seconds	30 seconds after the last fire, focus assist lamp will automatically get out.

## 10. Buzz Function

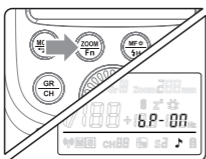

- To turn the buzz function on or off, press button and hold for 2 seconds to enter Custom Function.
- Then press "SET" button to enter "bp" mode. The LCD displays "ON" means buzz is turned on while "OF" means buzz is turned off.
- When the buzzer is turned on, is shown on the LCD display.

## 11. Wireless Flash Shooting: Ratio (2.4G) Transmission

- TT600 has 2.4G ratio transmission (Master/Slave)
- Wireless mode setting: Long press button and hold for 2 seconds until icon is blinking. Turn the Select Dial to set from OFF/Master(M)/Slave(S) mode.
- Channel setting: Long press button and hold for 2 seconds until the figure besides the CH is blinking. Turn the Select Dial to choose the channel from 1~32.
- Group setting: Short press button to select group. In

## Using the Flash

Master mode, groups can be selected from M/A/B/C/D/E; while in Slave mode, groups can be selected from A/B/C/D/E.

- As TT600 adopts Godox wireless X system, it is compatible with AD360II-C、AD360II-N、TT685C、TT685N、X1T-C、X1T-N wireless control, etc.
- See the picture below:

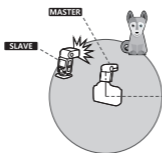

Transmission distance is about 100 meters

## 12. Wireless Control Function

- The flash unit is built in with a Wireless Control Port (6) so that you can wirelessly adjust the power level of the flash and control the on-or-off of your flash, focus assist beam and buzzer, as well as trigger the flash.
- To control the flash wirelessly, you need a Godox FT series remote control set (on-camera and on-flash). Insert its receive end into the Wireless Control Port (6) on the flash and insert the transmit end into the camera hot shoe. Settings made on the hotshoe-mounted transmit and receive ends will be wirelessly communicated to the flash. Then you can press the camera shutter-release button to trigger the flash. You can also hold the transmit end at hand to control your off-camera flash.

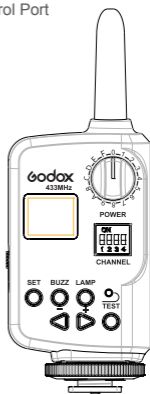

- For full instructions on the use of FT series remote control, see its user manual.

## 13. Sync Triggering

The Sync Cord Jack (7) is a  $\Phi 3.5$ mm plug. Insert a trigger plug here and the flash will be fired synchronously with the camera shutter.

## 14. Custom Function----Sleep Function

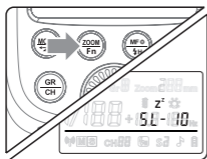

- This product is equipped with Sleep Function to avoid battery drain when the flash unit is idle.
- Press  $\langle$  ZOOM Fn  $\rangle$  button and hold for 2 seconds to enter the Sleep Function Mode. The LCD panel displays "SL" (Sleep) and "Sleeping Time". Idle time before entering Sleep Mode is 10 minutes by default. Rotate Select Dial

## Using the Flash

<  > to set a desired time for the flash or to turn off Sleep Function.

Press <  > button to return.



Idle Time	Meaning
OF	Sleep Function is turned off. The flash unit will not automatically enter sleep mode.
3	Idle time before entering Sleep Mode is set to 3 minutes.
10	Idle time before entering Sleep Mode is set to 10 minutes.
30	Idle time before entering Sleep Mode is set to 30 minutes.
60	Idle time before entering Sleep Mode is set to 60 minutes.

- When the flash enters sleep mode, the LCD panel displays a "Z<sup>z</sup>" icon.
- To wake up the flash unit, press any button on the flash unit, or press the camera release button, or press the trigger TEST button.

















### Note:

**The idle time before entering Sleep Mode is recommended to set short. This can ensure a longer battery life.**

## 15. C.Fn Setting Custom Functions

Custom Function Signs	Function	Settings & Description	Operation
SL	Sleeping Time Setting	Settable Time: <3> 3 minutes <10> 10 minutes <30> 30 minutes <60> 60 minutes <OF> ( OFF )	<ol style="list-style-type: none"> <li>1. Press &lt;  &gt; button to enter Custom Functions.</li> <li>2. Turn the Select Dial &lt;  &gt; to adjust sleeping time.</li> <li>3. Press &lt;  &gt; button to return.</li> </ol> <p>*Press any button can wake up the flash. * The idle time before entering Sleep Mode is recommended to set short. This can ensure a longer battery life.</p>

## Using the Flash

Custom Function Signs	Function	Settings & Description	Operation
FC	Auto Power OFF Time Setting of Auto Focus Assist	<10> 10 seconds <20> 20 seconds <30> 30 seconds	<ol style="list-style-type: none"> <li>1. Press  button to enter Custom Functions.</li> <li>2. Press  button to enter FC states.</li> <li>3. Turn the Select Dial  to adjust.</li> <li>4. Press  button to return.</li> </ol>
bp	Buzz Setting	<ON> On <OF> Off	<ol style="list-style-type: none"> <li>1. Press  button to enter Custom Functions.</li> <li>2. Press  button to enter bp states.</li> <li>3. Turn the Select Dial  to adjust.</li> <li>4. Press  button to return.</li> </ol>
bL	Backlight Setting	Backlight can be set as follows : <ON> : Always lighting <12> : Off in 12 sec. <OF> : Off	<ol style="list-style-type: none"> <li>1. Press  button to enter Custom Functions.</li> <li>2. Press  button to enter bL states.</li> <li>3. Turn the Select Dial  to adjust.</li> <li>4. Press  button to return.</li> </ol>
OS	Optic Slave Mode	<OF> Off <S1> S1 mode <S2> S2 mode	<ol style="list-style-type: none"> <li>1. Press  button to enter Custom Functions.</li> <li>2. Press  button to enter OS states.</li> <li>3. Turn the Select Dial  to adjust.</li> <li>4. Press  button to return.</li> </ol>



# Protection Function

## 1. Over-Temperature Protection

- To avoid overheating and deteriorating the flash head, do not fire more than 30 continuous flashes in fast succession at 1/1 full power. After 30 continuous flashes, allow a rest time of at least 10 minutes.
- If you fire more than 30 continuous flashes and then fire more flashes in short intervals, the inner over-temperature protection function may be activated and make the recycling time about 10 to 15 seconds. If this occurs, allow a rest time of about 10 minutes, and the flash unit will then return to normal.
- When the over-temperature protection is started,  is shown on the LCD display.

### Number of flashes that will activate over-temperature protection:

Power Output Level	Number of Flashes
1/1	30
1/2 +0.7	40
1/2 +0.3	50
1/2	60
1/4 ( +0.3,+0.7 )	100
1/8 ( +0.3,+0.7 )	200
1/16 ( +0.3,+0.7 )	300
1/32 ( +0.3,+0.7 )	500
1/64 ( +0.3,+0.7 )	1000
1/128 ( +0.3,+0.7 )	

### Number of flashes that will activate over-temperature protection in high-speed sync mode:

Power Output Level	Number of Flashes
1/1	15
1/2 ( +0.3,+0.7 )	20
1/4 ( +0.3,+0.7 )	30
1/8 ( +0.3,+0.7 )	
1/16 ( +0.3,+0.7 )	40
1/32 ( +0.3,+0.7 )	
1/64 ( +0.3,+0.7 )	50
1/128 ( +0.3,+0.7 )	

## Protection Function

### 2. Other Protections

The system provides real-time protection to secure the device and your safety. The following lists prompts for your reference:

Prompts on LCD Panel	Meaning
E0	A failure occurs on the temperature sensor. Please send this kit to a maintenance center.
E1	A failure occurs on the recycling system so that the flash cannot fire. Please restart the flash unit. If the problem still exists, please send this product to a maintenance center.
E2	The system gets excessive heat. Please allow a rest time of 10 minutes.
E3	The voltage on two outlets of the flash tube is too high. Please send this product to a maintenance center.

## Advanced Application

### • Bounce Flash

By pointing the flash head toward a wall or ceiling, the flash will bounce off the surface before illuminating the subject. This can soften shadows behind the subject for a more natural-looking shot. This is called bounce flash.

To set the bounce direction, hold the flash head and turn it to a satisfying angle.

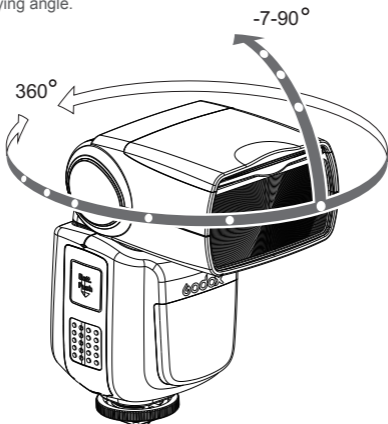

- If the wall or ceiling is too far away, the bounced flash might be too weak and result in underexposure.
- The wall or ceiling should be a plain, white color for high reflectance. If the bounce surface is not white, a color cast may appear in the picture.

## Advanced Application

### ● Creating a Catchlight

With the catchlight panel, you can create a catchlight in the subject's eyes to add life to the facial expression.

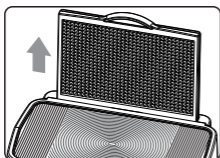

**1** Point the flash head upward by 90°.

**2** Pull out the wide panel. The catchlight panel will come out at the same time.

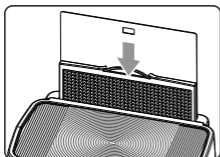

**3** Push the wide panel back in.  
● Push in only the wide panel.  
● Follow the same procedures as for bounce flash.

- ▲** ● Point the flash head straight ahead and then upward by 90°. The catchlight will not appear if you swing the flash head left or right.
- For best catchlight effect, stay 1.5m/4.9ft away from the subject.

### ● Using the Wide Panel

Pull out the built-in wide panel to enlarge the flash lighting range, so as to get more softened and natural lighting effect.

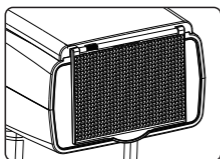

Pull out the wide panel and place it over the flash head as shown. The flash coverage will then be extended to 14 mm.

- The catchlight panel will come out at the same time. Push the catchlight panel back in.

## Technical Data

<b>Product Model</b>	<b>TT600</b>
Guide No. (1/1 power @ 200mm)	GN 60 (m ISO 100)
Vertical Rotation Angle	-7°-90°
Horizontal Rotation Angle	0-360°
Power Supply	Ni-MH batteries (recommended) or 4*LR6 alkaline batteries
Full Power Flashes	Approx. 230 (2500mA Ni-MH batteries)
Recycle Time	Approx. 0.1-2.6 seconds (eneloop Ni-MH batteries of Panasonic). Red LED indicator will light up when the flash is ready.
Flash Duration	1/300s - 1/20000s
Color Temperature	5600K±200K
Wireless Flash Function	Master, Slave, Off
Controllable slave groups	5(A, B , C , D, E)
Transmission Range (approx.)	100m
Channel	1~32
Dimension	64*76*190 mm
Weight without Battery	400g
Weight with Battery	500g

## Maintenance

- Shut down the device immediately should abnormal operation be detected.
- Avoid sudden impacts and the lamp should be dedusted regularly.
- It is normal for the flash tube to be warm when in use. Avoid continuous flashes if unnecessary.
- Maintenance of the flash must be performed by our authorized maintenance department which can provide original accessories.
- This product, except consumables e.g. flash tube, is supported with a one-year warranty.
- Unauthorized service will void the warranty.
- If the product had failures or was wetted, do not use it until it is repaired by professionals.
- Changes made to the specifications or designs may not be reflected in this manual.

**深圳市神牛摄影器材有限公司**

GODOX Photo Equipment Co., Ltd.

地址 /Add: 深圳市宝安区福永镇福洲大道西新和村华发工业园 A4 栋  
Building A4, Xinhe Huafa Industrial Zone, Fuzhou RD West, Fuyong  
Town, Baoan District, Shenzhen 518103, China

电话 /Tel: +86-755-29609320(8062) 传真 /Fax: +86-755-25723423

邮箱 /E-mail: [godox@godox.com](mailto:godox@godox.com)

<http://www.godox.com>