

SPLASH DRONE

Waterproof 3-Axis Gimbal Camera (GC-3) Manual

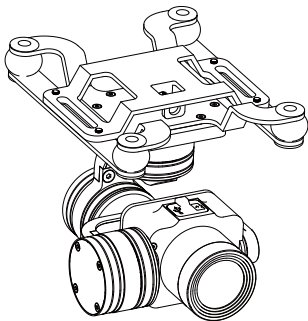

UrbanDrones

The official distributor, support and repair center
in the USA

www.UrbanDrones.com

Phone: 954-213-4977

12201 NW 35 Street Suite 220



Coral Springs, FL 33065

Attention	02
Installation	02
Operating the Gimbal	04
Gimbal Control	04
Camera Control	04
Camera	05
Installing a microSD Card	05
Camera Information Display	05
Camera Buttons	06
Camera Parameter Settings	07
Video Settings	07
Photo Settings	08
System Settings	08
Camera Indicator Light	08
Playback	08
Gimbal Calibration	09
Accelerometer Calibration	09
Gyroscope Calibration	10
Maintenance	10
Soaking and Rinsing the gimbal	10
Lubricating the microSD card sealing plug	11
Defogging the camera lens	11
Hydrophobic lens coating	11

Attention

- ⚠ Your SwellPro Waterproof gimbal incorporates precise electronics and corrosion-resistant materials that have been built to operate in the harsh marine environment. Like any marine equipment, long-life and trouble-free operation relies on due care and maintenance of the equipment.
- ⚠ When landing on water, descend vertically to the surface at a controlled rate. Landing with horizontal speed or impacting the water at speed causes unnecessary strain on the gimbal and can cause damage.
- ⚠ After flying in salt or contaminated water, always thoroughly soak and rinse the gimbal in fresh water immediately after use or before the water can dry inside the gimbal mechanism.
- ⚠ If salt or other sediments are allowed to dry inside the gimbal, thoroughly soak and clean all traces from the camera and gimbal before further use. Refer to the Maintenance section of the manual for further details.

1. Installation

Installation Diagram	Description
	1. If necessary, affix the quick release plate to the bottom of the fuselage with the mounting lug closer to the front of the drone.
	2. Remove the quick-release screw from the mounting plate.



3. Mount the gimbal, with the camera facing the front of the drone onto the quick release plate and secure it with the quick-release screw.



4. Plug the gimbal into the drone, taking care to align the guides or pins on the plug with the socket. When aligned, press the plug firmly into the socket and tighten the waterproofing ring.

2. Operating the Gimbal

Gimbal Control

Remote Control Operation	Description
Pan Control Tilt Control 	<p>Tilt Control Thumbwheel: Controls the camera tilt from looking forward to looking straight down (0° to -90°).</p> <p>Pan Control Thumbwheel: Controls the camera pan angle left and right of centre (-25° to 25°).</p>

Remote Control Operation	Description
Video Preview Photo 	<p>Video: Records Video</p> <p>Preview: Previews without recording</p> <p>Photo: Takes a still image</p>

3. Camera

3.1 Installing a microSD Card

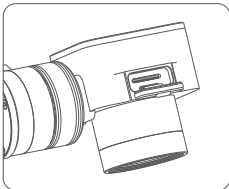

1. Open the soft rubber sealing plug at the top of the camera.
2. With the microSD label facing the back of the camera, gently insert the card into the card slot.
3. Press the card down until you hear a faint click and the card remains fully inserted.

⚠ The SwellPro GC-3 camera supports microSD cards with a maximum capacity of 64GB. When selecting a microSD card for use with your camera, for best results always ensure that the card is rated for 4K video throughput Class 10 or UHS-1 or better.

⚠ Do not insert or pull out the microSD card with the camera turned on as this may damage data on the card.

⚠ If recording video, to save the file correctly, ensure that the camera is switched back to Preview on the remote controller BEFORE turning the camera off or removing the battery from the drone.

3.3 Camera Information Display



- Video Recording Mode
- Video Resolution
- Available Recording Time
- Recording Time
- Red Dot/Slow Flash
- Photo Mode
- Photo Resolution
- Number of photos remaining
- Storage Card Icon
- No Storage Card

3.4 Camera Buttons

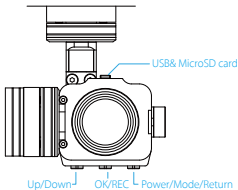

● Power/Mode/Return button

1. If the camera is OFF, press the Power button for 2sec to switch ON, the status indicator light will flash 3 times.
2. To switch OFF the camera, press the Power button for 2sec to switch OFF, the status indicator light will flash 7 times.
3. In Preview mode, press the Power button to cycle modes: Video---Photo---Setup---Playback---Preview--- Video...
4. In Setup mode, press the Power button to return to the previous menu.

● OK/REC button

1. In Video mode, press the OK button to start and stop recording
2. In Photo mode, press the OK button to take a photo.
3. In Setup mode, press the OK button to enter the select the current option.
4. In Playback mode, press the OK button to start playing the selected video, during playback pressing OK again will pause or restart the video.
5. In Playback mode, long press the OK button to delete the current file. The screen will show a confirmation message. Use the Up/Down to select the tick mark and press OK to confirm.

● Up/Down button

1. In Setup mode, press to move down through the menu, press and hold to move upwards.
2. In Preview mode, press to switch between Video and Photo mode.

3.5 Camera Parameter Settings

Camera settings interface

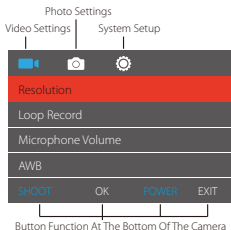

Video Settings

Video Resolution PAL: 4K: 3840x2160 25p 2.7K: 2720x1530 25p 2.5K: 2560x1350 50/25p

FHD: 1920x1080 100/50/25p HD: 1280x720 200/100p

NTSC: 4K: 3840x2160 30p 2.7K: 2720x1530 30p 2.5K: 2560x1350 60/30p

FHD: 1920x1080 120/60/30p HD: 1280x720 240/120p

Loop Record Off 2Min 3Min 5Min

Microphone Volume Off 50% 60% 70% 80% 90% 100%

AWB AUTO/ Incandescent / D4000 / D5000 / Daylight Lamp / Cloudy / D9000 /
D10000 /Fluorescent /Water

EV Value -2 -1.7 -1.3 -1.0 -0.7 -0.3 0 +0.3 +0.7 +1.0 +1.3 +1.7 +2.0

Metering Center Multi Spot

Photo Settings

Photo Size	16M(4608x3456 4:3) 12M(4000x3000 4:3) 8.3M(3840x2160 16:9)
Self Timer	Off 3Sec 5Sec 10Sec
Photo Burst	Off 3Pic/Sec 5Pic/Sec 10Pic/Sec
Timelapse Photo	Off 3Sec 5Sec 10Sec
AWB	AUTO/ Incandescent / D4000 / D5000 / Daylight Lamp / Cloudy / D9000 / D10000 /Fluorescent /Water
EV Value	-2 -1.7 -1.3 -1.0 -0.7 -0.3 0 +0.3 +0.7 +1.0 +1.3 +1.7 +2.0
ISO	AUTO 100 200 400 800 1600
Metering	Center Multi Spot

System Settings



TV Mode	NTSC PAL
Light Frequency	AUTO 50HZ 60HZ
Language	English/ Simplified Chinese/ Traditional Chinese/ Russian/ Deutsch/ Francais/Italiano/Espanol/ Portuguese/Suomalainen/ Dansk/ Svensk/ Norsk sprak/Magyar/ Nederlands/ Slovencina/ Greece

Format

Reset Factory Settings

Swellpro-V1.0.18

Camera Indicator Light

	Green light fast flash 3 times	Power On
	Green light fast flash 7 times	Power Off
	Green light slow flash	Read and write data or video

Playback

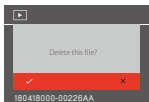

1. In Playback mode, short press the OK button to start playing the selected video, when playing, short press the OK button to pause, short press again to continue playing.
2. In Playback mode, long press the OK button to delete the current file. The screen will show a confirmation message. Use the Up/Down to select the tick mark and press OK to confirm.

4. Gimbal Calibration

The sensitive gyroscope and accelerometer in the gimbal have been calibrated by the factory. However, environmental conditions or a crash landing may require the gimbal to be recalibrated.

If after powering up the gimbal, and allowing 15 seconds for the gimbal to complete its power-up process, the picture is not level, the Accelerometer requires calibration.

Accelerometer calibration

1. Put the aircraft on a horizontal surface, power on the Remote Controller and then the drone. Wait 15 seconds for the gimbal to complete its power up process.
2. Scroll BOTH the gimbal control wheels (Pan and Tilt) to the FAR-LEFT and hold in this position for 6 seconds until the gimbal appears to lose power.
3. Insert a spacer to support the camera in a perfectly level position. A thin book may be suitable.
4. Hold the camera firmly in the level position and scroll the right-hand (TILT) control wheel to the hard right for 2 seconds.
5. Power down the drone. Remove the Gimbal Lock and repower the drone.
6. The calibration is complete.

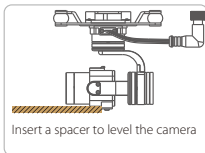
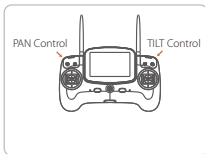



Gyroscope Calibration

If the horizon of the camera alters after initially being level, the gimbal gyroscope requires calibration.

1. Put the aircraft on a horizontal surface, power on the Remote Controller and then the drone.
2. Scroll BOTH the gimbal control wheels (Pan and Tilt) to the FAR-RIGHT and hold in this position for 6 seconds until the gimbal appears to lose power.
3. The gimbal will then recalibrate its gyroscope.
4. Power down the drone for at least 10 seconds and then repower the drone.
5. The calibration is complete.

After completing the calibration, please power down and restart the drone.

 The gimbal must be powered down and repowered to complete calibration. It is normal for the gimbal to be out of level during the calibration process.

 During the accelerometer calibration procedure, the camera Gimbal must be placed on a horizontal surface, without any vibrations. If any abnormality still persists after attempting calibrations, reboot the drone and re-calibrate the Gimbal carefully following the instructions.

5. Maintenance

Like any marine equipment, long-life and trouble-free operation relies on due care and maintenance of your equipment.

After flying in salt or contaminated water, always thoroughly soak and rinse the gimbal in fresh water immediately after use or before the water can dry inside the gimbal mechanism.

Soaking and rinsing the gimbal

If salt or other sediments are allowed to dry inside the gimbal, thoroughly soak and clean all traces from the camera and gimbal before further use.

1. Remove the camera from the drone
2. Locate a container just large enough to hold the gimbal camera in an upright position.
3. Place the gimbal into the container.
4. Fill the container with clean, fresh water, being careful to keep the electrical connector dry. Ensure the gimbal motors are completely immersed.
5. Allow the gimbal to soak for 30 minutes.
6. Rinse the gimbal once again and dry before storage.

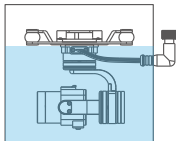

Lubricating the microSD card sealing plug

To ensure a waterproof seal, the microSD sealing plug needs to be clean and free of sand or other particles. A small amount of silicone lubricant can be applied to the microSD sealing plug.

Defogging of the camera lens

When cameras are subjected to changing temperature and humidity levels, it is normal for some fogging of the camera lens to occur. To minimise the risk of fogging of the camera lens:

1. Only open the microSD hatch in dry, warm conditions.
2. Store the gimbal in dry conditions with the microSD hatch open.
3. Should the camera fog during use, open the hatch in dry conditions and allow air to circulate inside the camera housing. Condensation will usually dry within a few minutes.

Hydrophobic lens coating

The lens of your SwellPro camera has been treated with a hydrophobic coating to help disperse water quickly after landing on water or when flying in the rain.

Over time this coating can be removed by exposure to sunlight and the cleaning of the lens. The outer lens of the camera is glass and can be retreated as required with commercially available treatments such as 'Rain-X™'.

SPLASH DRONE

Waterproof 3-Axis Gimbal
Camera (GC-3) Manual

V1.1 2018.09