

spry

User Manual v4.2

Check www.urbandrones.com for the latest version of this manual and firmware updates for your drone.

UrbanDrones

UrbanDrones.com

Sales and support center in the USA

Phone: 954-213-4977



The world's only waterproof sport drone.

SwellPro

PIONEERS OF THE WATERPROOF DRONE

Thank you for purchasing the SwellPro Spry. We have designed and manufactured the Spry to the highest quality standards. Like any marine equipment, long-life and trouble-free operation relies on due care and maintenance. With proper care and maintenance you should enjoy your drone for many years. After flying in salt or contaminated water, always thoroughly rinse and dry your Spry in fresh water immediately after use or before salt and sediment can dry inside moving parts.

[It is important to familiarize yourself with the features of this unique drone by carefully studying this manual and particularly the priority sections indicated in the Table of Contents.](#)

Check www.urbandrones.com for the latest manuals, software and tips. Refer to the Version Information section at the end of this manual, which details additions and corrections to this manual.

Other Information

Visit and subscribe to SwellPro's YouTube channel for instructional videos and product information.



www.facebook.com/urbandrones/

Register your Product Warranty

Please ensure you register your product as soon as possible to ensure warranty coverage.
www.swellpro.com/



Product Overview	05
Product Overview	05
Drone Illustration	06
Remote Controller Illustration	07
FPV Screen OSD Illustration	08
Flight Modes	08
Return Home	10
Drone Indication Lights	11
Propellers	11
Micro SD Card Installation	12
Battery	13
Battery Installation	13
Low Battery Alarm	14
Low temperature precautions	14
Remote Controller	14
Charging Remote Controller Battery	15
Low Battery Alarm	15
Remote Controller Operation	15
Remote Controller Pairing	17
Camera	18
Camera Settings and Use	19
Camera Indicator	20
Flight	20
Basic knowledge before fly	20
Preparation Before your First Flight (or in a new location)	21
Gyroscope Calibration	21
Compass Calibration	22

IMU calibration	23
Starting / Stopping the Motors	23
Basic Flight Steps	24
Water Take-off and Landing	25
Take-off and Landing from a Boat	25
APP Control	27
Tap to Fly	28
Flight Path Setting	29
Flight Safety	30
Battery Related	30
Maintenance	32
Trouble Shooting	33
Disclaimer and Warning	33
Appendix	35
Specifications	35
Warranty Information	36
Version Information	37

Product Overview

Spry is the first-ever compact & portable waterproof sports drone. Its fully waterproof fuselage and built-in camera helps you capture photos and 4K/30fps video in all weather conditions. The competitive power system allows you to experience high-speed flight over water - enjoying true freedom. This section introduces the various drone functions, how to assemble the drone, the various part names of the drone, and its remote controller.

Highlighted Features

1. The Spry fuselage and remote controller are waterproof and suitable for all-weather, all-terrain cruising.
2. The aerodynamic shape of the whole drone is designed to effectively minimize wind resistance and improve flight speed.
3. Spry's camera uses a Sony 1 / 2.3 inch CMOS sensor matched to a lens that minimizes fisheye distortion to obtain natural-looking scenes. Use your Spry to record stunning 4K videos at 30 frames per second or take high-definition 12MP photos.
4. Adjustable lens angle: The Spry' s camera can be tilted up and down with the remote controller to frame your videos better.
5. Optional electronic stabilization system helps ensure smoother footage.
6. The Spry 4K waterproof camera is sealed in an optical glass dome to protect the camera lens from damage. The specially designed dome has high transparency without distortion and also helps avoid excessive glare.
7. Intelligent Follow Me: The Spry uses a built-in motion algorithm to follow the position of the remote controller. The follow me functions supports leading or following camera positions.
8. Target orbit: the Spry can perform an autonomous orbit around a moving object.
9. Auto return: The Spry constantly monitors the location of the remote controller so that it can return to the last-known position of the pilot in case of radio interference or a return-home command.
10. APP smart control: One Key Take Off | Point to Fly | Orbit Fly | Auto Return | Flight Path Settings
11. Compact, portable and easy to use.

Drone Illustration

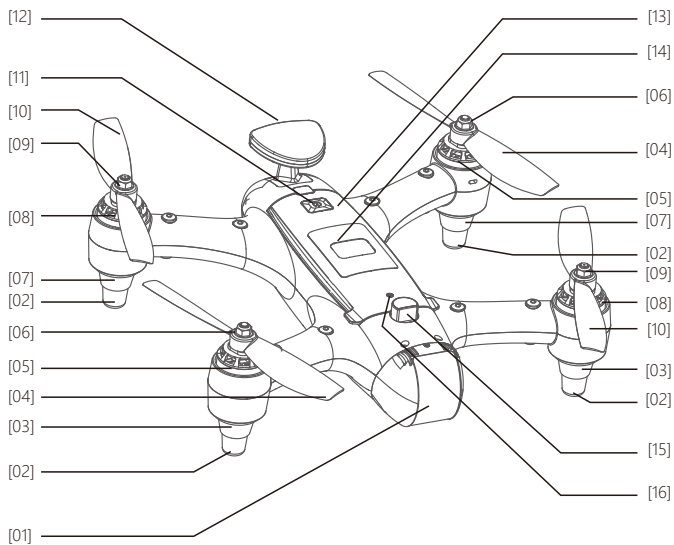

[01] Camera Dome

[02] Rubber Feet

[03] Drone Nose Lights

[04] CCW Propeller

[05] CCW Motor

[06] CCW Propeller Nut

[07] Drone Status Lights

[08] CW Motor

[09] CW Propeller Nut

[10] CW Propeller

[11] Power Button

[12] GPS pod

[13] Battery Cover

[14] Waterproof Membrane

[15] Battery Cover Lock

[16] Battery Cover Mount

Remote Controller Illustration

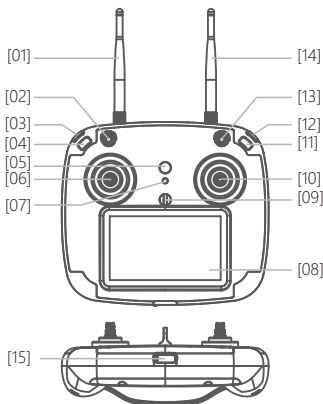

- | | | |
|---|---|--|
| [01] 2.4G Remote Antenna
For drone control signal | [06] Left Joystick
Control the drone's ascent (up), descent (down) and/or to rotate the aircraft nose left or right. | [11] Camera Button
Used for controlling Video and Photo functions. |
| [02] Return-Home Switch
Commands the drone to return automatically | [07] FPV Channel Button
Press and hold to search for the best FPV channel | [12] Camera Up Button
Tilts the camera up |
| [03] Camera Tilt Down Button
Tilts the camera down | [08] FPV Screen
Displays flight data and FPV video | [13] Flight Mode Switch
GPS / Circle / ATTI |
| [04] Follow Me Button
Controls the drone to follow the remote controller | [09] Hanger Ring
Attachment point for neck lanyard | [14] 5.8G FPV Antenna
Receives FPV live video 5.8GHz |
| [05] Power Button + Controller Status Light
Press and hold to power on the remote controller. The button will glow to indicate remote controller status. | [10] Right joystick
Controls the drone direction of flight | [15] USB Port/Vent plug
For charging the remote controller battery and performing firmware upgrades |

⚠ Before powering on the controller, please be sure to put all the toggle switches on the controller in the up position.

⚠ As the remote controller is completely sealed, the air inside is subject to changes in pressure and temperature. If the rubber joystick seals balloon or suck in, simply equalize the pressure inside the remote by briefly opening the USB charge plug.

Note: The default remote control configuration uses a left hand throttle. If you prefer to have right hand throttle, please consult your local dealer.

Display Interface

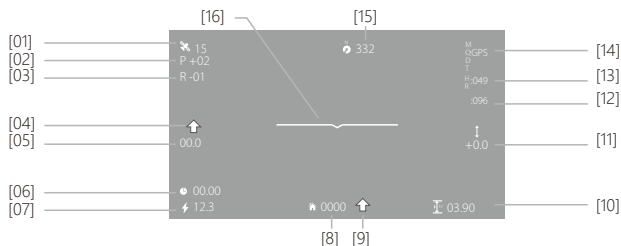

[01] GPS satellites tracked	[07] Drone battery voltage	[13] Current throttle
[02] Angle of aircraft pitch	[08] Distance from the take off point	[14] Flight mode
[03] Angle of aircraft roll	[09] Home point direction relative to drone	[15] Compass bearing
[04] Flight direction	[10] Vertical height	[16] Flight attitude
[05] Flight speed	[11] Vertical speed	
[06] Flight time	[12] Remote controller signal strength	

⚠ If [04] and [09] both point in the same direction, the drone is flying towards to remote controller/home point.

Flight Modes

The Spry utilizes a brand new flight control system which incorporates 6 of the best flight modes.

GPS mode: This mode uses the GPS module to achieve accurate and stabilized hovering, braking, intelligent flight, intelligent return and other intelligent flight mode functions. In this mode, maximum flight speed is 10m/s, maximum ascent speed is 3m/s, and maximum descent speed is 3m/s.

Circle mode: The drone moves 10m from its current location and begins to circle with a radius of 10m with the nose always facing the origin. During circling, the right-hand joystick controls the speed and size of the orbit. Push up to increase the radius of the orbit, push down to reduce the radius of the circle (minimum radius 10m), push the joystick left to speed up the orbit or push it right to slow down the orbit. If you continue to reduce the orbit speed, the drone will change the direction of orbit and start to increase the orbit speed again.

ATTI mode: This is a more advanced flight mode which does not use the GPS positioning function but still maintains altitude stabilization. The drone will drift with any wind when hovering and will not brake when the joysticks are released.

Follow Me: The remote controller has an inbuilt GPS module, and the Follow Me mode is based on the relative position of this GPS module to the drone. The maximum Follow Me speed is 10 m/s (36 KM/H).

Auto-Return: The aircraft has a one-key return function as well as an auto-return if radio contact with the remote controller is lost. When the remote control and GPS signal are good, the aircraft can be commanded to automatically return to the current remote control position.

Circle & Follow Mode: Specifically designed for shooting moving objects, this mode is ideal for taking pictures of moving boats. There are 2 ways to activate this mode: 1. enter the Circle mode, then push the Follow Me button; 2. enter the Follow Me mode, then flick the mode stick. Working mode: When the aircraft switch from Circle mode to Circle & Follow me mode, the aircraft will slowly circle the remote control with a radius of 10 meters; when the aircraft switches from the Follow me mode to Circle & Follow me mode, the drone will fly to a radius of 10 meters and start to circle. It is recommended the Follow Me speed is under 2 m / s, beyond this speed, it is possible to lose the aircraft.

-
- ⚠ In the GPS mode, the drone will not arm unless there are sufficient satellites to establish the home point. This point is used if the drone cannot establish the location of the remote controller.
 - ⚠ In ATTI mode, the drone's top speed is faster than in GPS mode. When flying in a calm environment, the pilot should allow a minimum of 30 meters of braking distance to ensure flight safety.
 - ⚠ Flying in Atti mode requires more skill and caution. If you lose control of the drone in ATTI mode, switching to GPS mode can help stabilize flight as long as there is sufficient GPS coverage.
 - ⚠ In Follow Me mode, the joysticks are disabled. Press and hold the Follow Me button again to cancel Follow Me - the Controller Status Light will flash red confirming Follow Me mode has been cancelled and joystick function has been restored.
 - ⚠ If the GPS module in the remote controller does not have an accurate fix, the controller status light will flash red, Follow Me cannot be started.
-

Return Home

SPRY has two Return Home modes: Manual Return and Out-of-Range Return.



Manual Return: When you activate return function of the Spry, it will return to the remote controller. When returning to the remote control 30 meters away, the aircraft will record the coordinates of the remote control as the final return point. At this point, users can leave this location and let the aircraft land. (During the return flight, if you operate the joystick, the aircraft will stop returning. If you stop operating the joystick, the aircraft continues to return)

Out-of-Range Return: If the drone loses contact with the remote control for any reason, the aircraft will execute an automatic return to the last-known position of the remote control. During the return flight, if the aircraft is reconnected to the remote control signal, the automatic return will be cancelled and the Spry will await instructions from the remote controller.

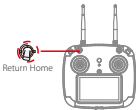
Operation

Illustration	Description
	<p>Press and hold the Return Home switch for 2 seconds, the system will beep and start the return process. At this point, the aircraft will auto-return to the remote controller. "RTH" is displayed in the upper right corner of the remote control screen.</p> <p>To cancel the Return Home process, press and hold the Return Home switch for 2 seconds, the system will beep and cancel the return process after both joysticks have been moved.</p>

Return Process

Flare Maneuver	Description
	Regardless of the vertical height, if the horizontal distance is <20 meters, the drone will maintain its height and return.
	Vertical height < 30metres and horizontal distance > 20metres, the drone will ascend up to 30metres, and then return.

- ⚠ Regardless of the vertical height, if the horizontal distance is <20 meters, the drone will maintain its height and return.
- ⚠ During automatic Return Home, when the remote control signal is restored, switch the Flight Mode briefly between GPS and ATTI mode and move the right joystick to take control of the drone and cancel automatic return.

Drone Indication Lights

The fuselage of the drone includes a pair of Drone Nose Lights and Drone Status Lights on the rear arms. Their positions are shown below:

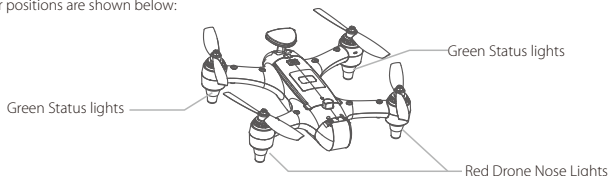

The Red Drone Nose Lights are used to indicate the direction of the nose of the drone, they will be solid red when the drone is powered on. The rear Drone Status Lights are green and indicate the status of the current flight control system. Please refer to the following table for the different flash modes for the Drone Nose and Status Lights.

Drone Nose and Status Light Messages

Aircraft initialization / horizontal calibration:

● ● ● ● Alternating Red, Green slow flashing Aircraft initializing / horizontal calibration

Drone power on/off

● ● ● ● ● ● ● ● Red Fast Flashing Remote control connected but still locked

● ————— Red ON Remote control connected and drone unlocked

Remote controller signal

● ● ● ● ● Red Slow Flashing Remote controller signal lost

GPS Status

● ● ● ● ● Green Slow Flashing Poor GPS signal

● ————— Green ON Good GPS signal

Compass Calibration

● ● ● ● ● ● ● ● Green Fast Flashing Horizontal calibration

● ● ● ● ● Green Slow Flashing Vertical calibration

Low Battery Warning

● ● ● ● ● ● ● ● Red Fast Flashing Low battery warning

Propellers

Spry comes with 6" 2-bladed propellers and is also compatible with 5" 3-bladed propellers. The 2 blade speed is slower, but the flight time is longer than the 3 blade. You can choose propellers to suit your requirements.

Installing and removing the propellers:

1. Place each propeller onto the motor hubs according to the diagram below. The propeller type is stamped on the top of the propeller blade. Propeller types that end with the letter "R" are fitted to clockwise (CW) motors. If propellers are fitted incorrectly, the drone will crash.
2. Hold the motor with one hand while tightening the propeller nut. Tighten the nut only until the propeller does not turn on the motor. Overtightening the propeller nut will damage the motor.
3. Before each flight, check that the propellers are smooth and undamaged.

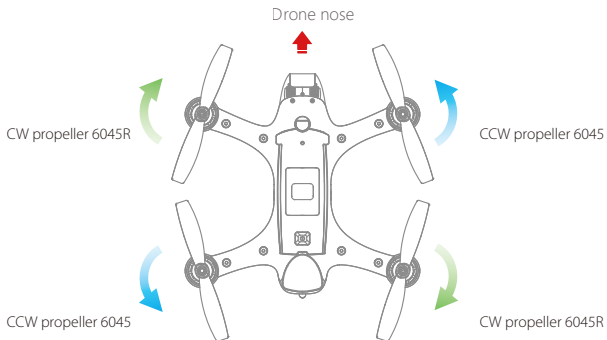

Micro SD Card Installation

When selecting a microSD card for use with your camera, for best results always ensure that the card is rated for 4K video throughput.

To insert the card, place the microSD card face-up in the recess inside the battery compartment. Carefully slide the card towards the nose of the Spry until it clicks and locks into place.

To remove the card, push the card gently towards the nose of the Spry until it clicks and then ejects. Take care to prevent the card from ejecting too fast out of the slot.

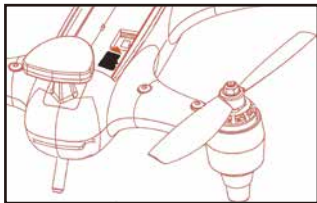

Battery

The Spry is supplied with a high-voltage lithium battery (LiHV) and a corresponding charger.

To charge the drone battery: Plug in the charger. After 3 seconds, its four status lights will flash left and right indicating the charger is ready. Connect the battery to the charger using the supplied adapter cable. The larger plug on the cable is inserted into the top port of the charger. The plugs can only be inserted one way and do not require force. If the plug is difficult to insert, try the other orientation.

After the battery is connected, the four battery status indicators show the level of charge: 25%, 50%, 75%, and 100%. When all 4 lights are permanently ON, the battery is fully charged.

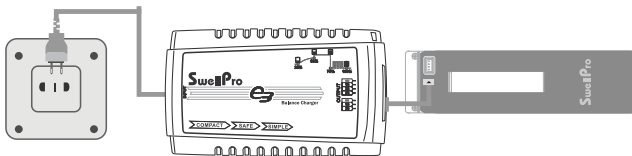

⚠ Note: If the four indicators flash at the same time, the charger or battery is faulty. Stop charging and check all connections.

Battery Installation

- 1 · Twist open the battery hatch lock. Grasp the forward end of the battery cover with the provided tool and pull the battery cover up.
- 2 · Insert the battery vertically into the drone with the contacts towards the back of the drone and **press down until it is properly seated.**
- 3 · Check that the seals on the cover are clean and lightly lubricated. **Insert the back of the cover first, ensuring that the cover is securely under the clip at the base of the GPS dome,** then press down on the cover to seal the battery compartment.

4. Twist the battery cover lock to lock the cover in place.

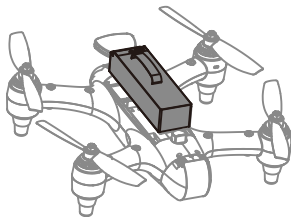

Low Battery Alarm

When the drone battery voltage drops to a low level (10.9V), the Drone Nose Lights will fast-flash red. The pilot will simultaneously receive warnings on the remote controller. The screen will display "Aircraft Low Battery" and the controller will beep and vibrate. Find a suitable place to land as soon as possible. If the aircraft voltage drops to 10.7V, the aircraft will slowly and automatically land in place.

During auto-landing, the pilot can use the remote controller to alter the landing site, but this should be done within one minute or the battery will be over-discharged and the drone may crash.

⚠ During flight when the voltage warning appears on the remote controller screen, prepare to return and land the drone as soon as possible.

⚠ Power OFF the drone when not in use to prevent over-discharging and permanently damaging the battery. Battery damage is not covered by warranty.

Low temperature precautions

1. In low temperature environments (-0C degrees to 5C degrees) , flight time will be reduced. Ensure batteries are fully charged and kept warm (20~30C) before use.

2. Also be aware that the low battery warnings will provide less warning time, so land the drone as soon as the first battery warning appears.

3. After landing on cold water, the drone may need up to 15 seconds to stabilize its gyroscope before being able to re-arm. Consider this before landing on water particularly if there are waves.

Remote Controller

This section introduces the remote controller functions, including drone and camera operation.

Charging the Remote Controller Battery

The Spry Remote Controller has a built-in battery and charging circuit. Charge the controller using the supplied micro-USB cable and a regular 5V/2A USB charger. Normal charging time is ~90 minutes.

Some USB ports and some USB cables cannot provide the full 2 amps (2A) of power required. These ports and cables can still be used to charge the Remote Controller but the charging time will be longer.

During charging, the remote controllers power button will glow blue. When charging is complete the blue light will turn off. Charging is possible during flight if necessary, but the remote must be connected to the drone before connecting the charging cable.

Low Battery Alarm

The remote control has a built-in lithium battery and the operating time is about 2 hours. When the remote controller battery is low, the remote control will beep and the battery power icon in the upper right corner of the screen will be red. The remote control will then have approximately 10 minutes of power left. It is best to return the drone and land as soon as possible or plug in the controller to charge the battery.

Remote Controller Operation

The Spry Remote Controller operates using two frequency bands, 2.4GHz and 5.8GHz. The 2.4GHz band is used for drone control and 5.8GHz is for the FPV video signal. The remote control has a built-in 4.3-inch FPV screen that displays real-time images and flight data of the aircraft.

Power Switch

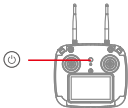
Illustration	Description
	<p>Power on: Long-press the power button for 3 seconds, the remote controller will vibrate, beep and the screen will turn on.</p> <p>Power off: Long-press the power button again for 3 seconds to turn off the remote controller.</p>

One Key Return Home Switch

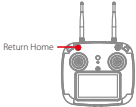
Illustration	Description
	<p>On: Long-press the Return Home switch until the the controller beeps. The aircraft enters the return state, and the FPV screen will display "RTH".</p> <p>Cancel Return Home: Long-press the Return Home switch until the controller beeps. and operate both joysticks to regain control.</p>

Flight Mode Switch

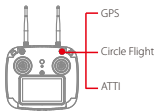
Illustration	Description
	<p>GPS: GPS mode</p> <p>Circle Flight: Orbit mode</p> <p>ATTI: ATTI mode</p>

Follow Me mode Switch

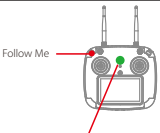
Illustration	Description
 <p>Follow Me</p> <p>Green Status light indicates good GPS fix.</p>	<p>When the Controller Status Light is solid green, this indicates that the GPS of the remote control has a fix and the Follow Me function is available in GPS and Circle mode</p> <p>To activate Follow Me, Long-press the Follow Me button "F" for 2 seconds until a beep sounds. The Controller Status Light will change to solid red, indicating that the aircraft is in Follow Me mode.</p> <p>Long-press the "F" button again for 2 seconds to cancel Follow Me.</p>

- ⚠ In the Follow Me mode, the joysticks are disabled. Long-press the "F" button again to cancel Follow Me and resume joystick operation.
- ⚠ When the speed of the remote controller exceeds 10m/s during Follow Me operation, the drone will continue to fly forward at the maximum speed. At this time, you can slow down or stop to wait for the aircraft. If you're out of the remote control's effective range, the aircraft will return to the position where the GPS signal of the remote control that was final received.
- ⚠ If the remote controller's GPS does not have a fix, the Follow Me function cannot be activated.

Drone Control

Left hand throttle- (American/ European configuration)

- ⚠ Please contact us if you need to change to right hand throttle.

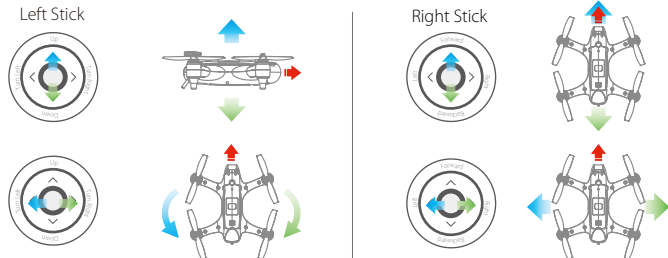

Remote Controller Pairing

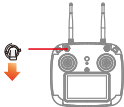
Illustration	Description
	<ol style="list-style-type: none">1. To pair the remote controller to the drone, while holding the Return Home switch down, power on the remote controller.2. The remote controller will vibrate and beep twice. The Controller Status Light will flash red and green.3. Power on the drone. After pairing has completed, the Controller Status Light will turn green.4. Long-press the FPV channel button (CH). The FPV screen will display "RF SEARCHING" and automatically find the best FPV channel.

FPV Channel Tuning

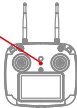
Illustration	Description
 <p>FPV Channel Button</p>	There are 8 FPV channels available. Long-press the FPV channel button (CH) and the system will automatically search for channels.

⚠ Always pair the remote controller and then select the FPV channel to match the best channels and avoid interference.



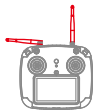

In the absence of obstacles and interference the flight height can reach >80m and FPV transmission range can reach 800m. For best reception, keep the left-hand (2.4GHz) antenna horizontal and the right-hand antenna (5.8GHz) vertical.

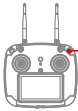

Camera Tilt Control

Illustration	Description
 <p>Camera up Camera down</p>	Camera up: Tilt camera up Camera down: Tilt camera down

Camera Control

Illustration	Description
 <p data-bbox="222 382 312 401">Photo/Video</p>	<p data-bbox="373 147 951 201">Long-press the camera button (five beeps) to start or stop video recording.</p> <p data-bbox="373 215 951 269">Short-press the camera button (two beeps) to take a photo. You cannot take a photo if video recording is started.</p> <p data-bbox="373 318 951 406">After taking a photo, the camera information window will display a camera icon  and the resolution of the photo. The card  icon indicates the remaining number of photos the microSD card can hold.</p> <p data-bbox="373 452 951 506">In video mode,  the card icon  indicates the remaining hours and minutes (hh:mm) the microSD card can hold.</p>

 The Spry will automatically save longer video files into chapter files of 4GB.

Always stop video recording before powering off the Spry or your video will be lost.

Camera

Spry's built-in camera can capture 4K videos and 12 megapixel still images. With its inbuilt WiFi function you can also use a mobile app to change settings and download videos and photos. This section introduces camera parameters and use.

Camera Settings

APP installation: The SwellCam2 app is available for iOS and Android devices. Android systems can download the APK from either the Android Play Store or our website www.swellpro.com.

To connect the app to the Spry's camera, power on the drone, then press the WiFi switch on the underside of the drone. The switch will begin flashing Red-Green. Connect your mobile device to the SwellPro... WiFi hotspot, the password is 00000000.

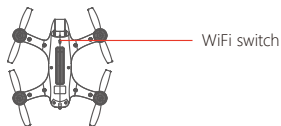

Using the APP: Open the camera APP. The screen will show the camera preview. With the APP, you can set the parameters for photos and video, you can also control the camera on the ground and take photos or videos.

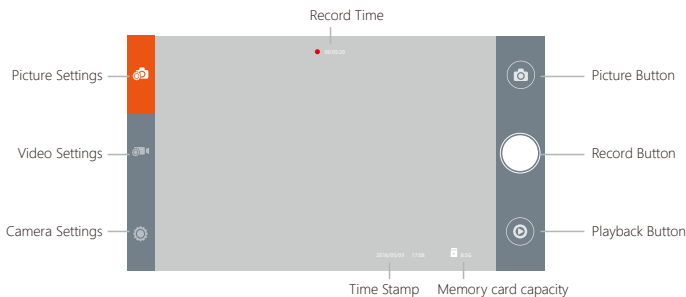

⚠ Turn off the camera's WiFi before flight by pressing the WiFi button.

⚠ When the camera is recording video, turning off the drone without first stopping the video will cause corruption of the video file. Always stop video recording before powering off the drone.

Camera Settings

Photo Settings

Picture Size	12M 16:9 12M 4:3
Burst Speed	OFF 3P/S 5P/S 10P/S
Interval Shooting	OFF 3s 5s 10s 30s 60s
Selfie-Timer	OFF 2s 10s

Video Settings



Resolution	3840x2160 30P 2704x1524 30P 1920x1080 120P/60P/30P 1280x720 240P
Electronic Stabilization	ON OFF
Record Format	MP4 MOV
Video Format	PAL NTSC

⚠ When electronic stabilization is on, distortion correction will also be turned on.

Camera Settings

EV	+2.0 +1.7 +1.3 +1.0 +0.7 +0.3 0.0 -0.3 -0.7 -1.0 -1.3 -1.7 -2.0
White Balance	AUTO, cloudy, sunny, Incandescent lamp, Fluorescent lamp
Distortion Correction	ON OFF
Metering	Global metering, Center-weighted, spot
Format	Confirm Cancel
About this device	firmware details
Restore Settings	Confirm Cancel

Camera Indicator

	Green slow flash	Camera recording
	Alternating Green-Red fast flash	WiFi ON
	Green ON	Camera in preview mode

Flight

Basic flight knowledge

If this is your first time flying a drone, please read this manual thoroughly and watch the instructional videos on our YouTube channel. We recommend taking professional training and guidance. When flying, select an environment appropriate to your skills. **It is advisable for all drone pilots to become familiar with flying in ATTI mode in case of GPS or magnetic interference, which can affect drone controls.**

1. Although the Spry is waterproof, do not fly in heavy fog or if the wind is very strong or gusting above Beaufort Force 4.
2. Don't fly near metal frame walls or structures as this can affect the GPS and compass signals. It is recommended to fly at least 10 meters away. Since the remote controller also has a GPS module inside, please ensure the pilot remains 10 meters away from metal frame walls.
3. Flying in a complex electromagnetic environment, (e.g. boat) radio equipment may interfere with the drone's 2.4G signals which may cause the aircraft to react slowly or become uncontrolled. In these situations, you can turn off the remote control for the aircraft to return automatically, or restart the remote control, which can assist re-establishing control.
4. When your drone is new, calibrate and fly several times over land to adapt the aircraft to the local environment before flying over water.
5. When flying at altitudes above sea level, environmental factors including air density reduce the performance of aircraft and therefore also the drone batteries.
6. When the temperature is below 10°C, the drone may not unlock. Power on the drone for a few minutes to warm up and then the motors can be unlocked.
7. Normally, only the Compass Sensor needs to be calibrated when you have a new drone, check the calibration section.
8. Aircraft does not support calibration on moving objects, such as boats.
9. Make sure the waterproof membrane is in good condition. The membrane prevents water from entering the drone but allows air pressure to equalise the drone's altimeter to operate correctly. Avoid touching the membrane with your hands. If the membrane is dirty or completely soaked it will cause the altimeter to work abnormally and the drone might not hover or fly well.

10. Pre-Flight Inspections and Checks: batteries charged, propellers in good condition and correctly fastened, all motors spin smoothly by manually rotating. battery cover is clean, free of dirt, sand, or any other contaminants, drone fuselage is sealed and the membrane on the top of battery cover is in good condition.
12. Unless it is an emergency, NEVER Lock or STOP the motors in flight as this will cause the drone to fall to the ground and crash.
13. When the low battery level warning is activated, plan to return the drone and land safely before the battery reaches a critical level.
14. If any obstacles are in the flight path of the drone during a Return Home process, control should be regained by turning off the Return Home function.
15. If control of the drone feels slow or the drone pulls to one side, try switching to ATTI mode to check if the drone flies level. In ATTI mode, although the drone will drift with the wind, the body of the drone should remain level with no joystick input. If this check shows that the drone body is unbalanced, land the drone and perform a gyroscope calibration.

Preparation Before your First Flight (or in a new location)

The drone relies on very sensitive sensors to control flight positioning and stability.

Before your first flight, or if your flight is more than 100km from your last flight - you must perform a compass calibration.

* If you are planning to fly the drone from a boat or pontoon platform, you must calibrate the drone beforehand on stable ground.

Gyroscope Calibration

The gyroscope is used by the drone to sense its position and orientation. If the gyroscope is not well calibrated the drone will not fly predictably or may constantly lean to one side. This must be corrected immediately or the drone may increasingly become uncontrollable and crash. The drone may also display the message "Gyro Calibration" on the remote controller screen. In all these situations, gyroscope calibration is required.

Note: When the drone is floating on water, it is normal to intermittently see the "Gyro calibration" message - - this is due to the motion of the water and does not indicate that calibration is required.

How to calibrate the Gyroscope:

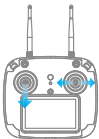
Illustration	Description
	<ol style="list-style-type: none"> <u>1. Place the drone on a stable horizontal surface free of vibration. Power on the remote controller and the drone. Wait for initialization to complete.</u> <u>2. Pull the left joystick down to the lowest position and then fast flick the right joystick left and right continuously until "INITIALIZING....." appears on the FPV screen.</u> <u>3. The drone will now perform gyrocalibration. Do not move or disturb the drone during this process. When the "INITIALIZING" message disappears from the FPV display, the process is complete. Restart the aircraft.</u>

* Gyro calibration on board a ship or on a moving platform will not succeed. Calibrate before boarding.

* When doing gyroscope calibration, ensure that the aircraft is placed is not subject to any vibration or movement.

* Gyro calibration on board a ship or on a moving platform will not succeed. Calibrate before boarding.



Compass Calibration

The compass sensor is used by the drone to control its direction in flight. Due to the Earth's magnetic fields, it is necessary to calibrate the compass sensor for the local environment. The Remote controller screen indicates the compass reading and can help identify if the compass sensor requires calibration. If the drone turns by itself during forward flight, then the compass requires calibrating.

Compass calibration should only be necessary when the drone is new, repaired or the flight location is more than 100km from the last flight.

Compass Calibration

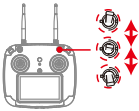
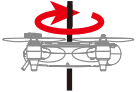
Compass Calibration is performed with the drone outdoors and away from any sources of magnetic interference such as metal structures, radio masts or mobile phones.

Illustration	Description
	1. Power on the remote controller and the drone, after the drone completes initialization, rapidly switch the Flight Mode switch backwards and forwards between the three modes until the drone screen displays "HORIZONTAL CALIBRATION Rotate Drone Clockwise".
	2. Holding the drone horizontally, rotate the drone clockwise until the green LED lights slow flash and the remote control screen displays "VERTICAL CALIBRATION Rotate Drone Clockwise".
	3. Hold the drone nose vertically downward, rotate clockwise until the screen displays "INITIALIZING" indicating the calibration is finished. Place the drone on a horizontal surface for 30 seconds to finish the initialization. Restart the drone.

IMU Calibration

The IMU accelerometer sensor is used to balance the aircraft.

To determine if the IMU is properly calibrated, place the drone on a completely flat and level surface. The (P)Pitch and (R) Roll values on the remote controller should read zero +/- 1 and remain stable. Additionally, if the drone's response feels skewed, the IMU may need recalibration.

*** Normally you don't need to calibrate the IMU. Never calibrate the IMU on a boat or moving platform.**

Note: When the drone is floating on water, it is normal to intermittently see the "IMU calibration" message - this is due to the motion of the water and does not indicate that calibration is required.

How to calibrate the IMU:

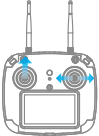
Illustration	Description
	<ol style="list-style-type: none">1. Place the drone on a stable horizontal surface free of vibration. Power on the remote controller and the drone. Wait for initialization to complete.2. Push the left joystick up to the highest position and then fast flick the right joystick left and right continuously until "INITIALIZING....." appears on the FPV screen.3. The drone will now perform IMU calibration. Do not move or disturb the drone during this process. When the "INITIALIZING" message disappears from the FPV display, the process is complete, restart the drone.

Starting / Stopping the Motors



Precautions before unlocking the motors:

- ⚠ Place the drone in an open area at least 3 meters away from you or others.
- ⚠ When the drone is powered on, the drone will do a self-check. When it's done, there will be a "DI" sound. Keep the drone stationary during initialization.
- ⚠ If ATTI mode is selected, there is no need to wait, you can unlock the motors and proceed to takeoff and fly immediately. We recommend new pilots unlock the motors in GPS mode. The motors can't be unlocked in Circle mode.
- ⚠ In GPS mode, if the number of satellites is insufficient, the remote control will vibrate when unlocking the motors, and will display "WARNING NO GPS" and the motors will not unlock.

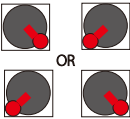
Unlocking (starting) the Motors

Illustration	Description
	<p>Pull both the left and right joysticks simultaneously towards either the lower inside or lower outside points. Maintain this position for 3 seconds to unlock the motors.</p>

Locking (stopping) the Motors (Operate cautiously)

Illustration	Description
 <p>OR</p> 	<p>Pull both the left and right joysticks simultaneously towards either the lower inside or lower outside points. Maintain this position for 3 seconds to lock the motors.</p> <p>Never lock the motors in flight unless there is an emergency as the drone will crash to the ground and may injure somebody.</p>
	<p>Alternatively, once the drone has landed smoothly, pull the throttle stick to the lowest position for 5 seconds to stop the motors.</p>

- ⚠ In GPS mode, if the number of satellites is insufficient, the motors will not unlock and the FPV screen will display a warning message.
- ⚠ Motors cannot be unlocked in Circle mode.
- ⚠ The motors can be unlocked in ATTI mode even if there is no GPS fix however no Home Point will be recorded for the Return to Home function.

Basic Flight Steps

1. Check that the drone is correctly assembled, propellers are tight and the main hatch is sealed.
2. Power on the remote control, followed by the drone.
3. Wait for the FPV screen to display the camera's live video and the OSD flight data. Check that the flight display is normal.
4. Place the drone on a flat open surface or on the surface of the water.
5. Check the following flight data: Battery voltage > 12.5volts, Satellites > 9, Compass indicates the drone's current compass direction.
6. For safety, you should stand upwind and to the side of the drone and at least 3 meters away.
7. Arm the drone then push the THROTTLE joystick up slowly, allowing the drone to take off smoothly. Release the throttle when the drone is approximately 1.5m high. Allow the drone to hover for a moment to ensure flight stability. Always use gradual, smooth joystick movements.
8. When you need to descend, slowly pull down the throttle joystick allowing the drone to descend and land on a flat surface or on the water.
9. After safely landing, keep the throttle down in its lowest position for at least 5 seconds until the motors have stopped or use the disarm joystick command.
10. Stop recording video before powering off the drone, followed by its remote controller.

Water Take-off and Landing

1. When taking off from choppy water, ascend quickly from the surface to prevent the drone being affected by a passing wave.
2. When landing on water, descend vertically to the surface. If the drone lands with horizontal speed, it is possible the drone can flip and be inverted. The flight controller will shut down the motors if the drone becomes inverted.
3. Do not leave the drone floating inverted for more than a few minutes. If the drone becomes inverted on the surface of the water, flip the drone by arming (unlock) the Spry and it will perform a Power Flip and right itself on the water.
4. When the drone lands on water, it is normal for the remote controller screen to display "Gyro Calibration Req". This is due to the movement of the water and does not indicate that the gyro requires recalibration.
5. After landing on water, if the drone does not hover well, land the drone and dry the membrane as it may have become saturated.
6. Always rinse the drone thoroughly after use on water and before salt crystalizes. Salt remaining on membrane will severely affect the performance of the aircraft.
7. The control distance of the remote control is affected by how far above the surface of the water the controller and drone are. The higher the controller is from the water, the further the control and video distance.
8. If the Remote Control is less than 2 meters above choppy water, the control distances of the drone will be affected.
9. Once the drone lands on water, radio reception is affected, particularly if there are waves on the water surface. Therefore, do not land on water unless the drone is closer than 100m. Video transmission is more affected by water than the control signals. Video transmission from the drone floating on the water back to the remote controller is limited to 30m.

When taking off from a boat there needs to be sufficient space, otherwise the drone should be placed on the water for take-off. It is safer and easier to land the Spry on the water beside a boat rather than landing on a rocking boat or where there is not enough space for a safe landing. If the boat is rocking, the Spry may not arm its motors in GPS mode. In this case, carefully take-off in ATTI mode and then switch to GPS mode if there are sufficient satellites.

For safety, it is not recommended to launch or land your Spry from your hands.

Be aware of the direction of the wind relative to the boat. Even when at anchor, it is possible that the wind will not be at the nose of the boat.

Always try and take off with the wind so that the drone will be taken away from the boat. When landing the drone onto a boat, if possible land against the wind so that the drone will be held away from the boat.

* When you are planning to fly the drone from a boat or a mobile platform ensure that the drone does not require calibration before boarding as calibration cannot be performed successfully in an unstable location.

The Spry remote controller has a built-in Wi-Fi module that can be used to connect your mobile device and control the aircraft to perform various intelligent automatic flight modes with the Spry APP.

APP Installation: The Spry app is available for iOS and Android devices. Android systems can download the APK from either the Android market or our website www.swellpro.com.

To connect the app to the Spry's remote controller, power on the remote controller and drone, then connect your mobile device to the WiFi hotspot called SP_FF1....

After successfully connecting, open the APP to display realtime data from the drone such as voltage, coordinates, altitude, distance, GPS signal and other flight parameters.

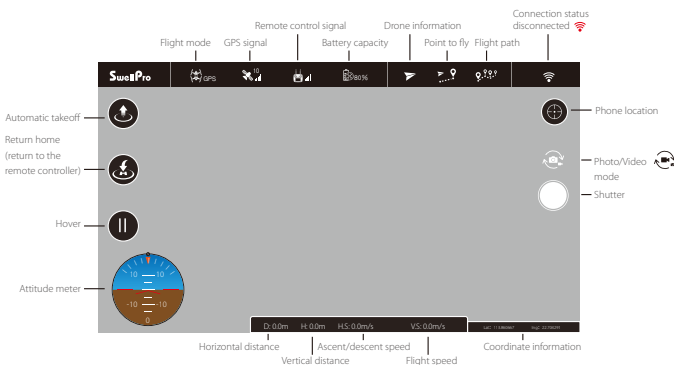

- ⚠ When flying indoors or in enclosed spaces, the lack of a strong GPS signal will affect the positioning stability of the aircraft. Do not use the APP to control the aircraft at this time.
- ⚠ If the aircraft is lost due to improper operation or malfunction, you can use the APP to locate the last coordinates to retrieve the aircraft. The Remote Control must be turned on to use the APP.
- ⚠ Because your mobile device needs to connect to the remote controller, it may be necessary to zoom into the APP map for the flying location prior to connecting to the remote controller in order to download map data.
- ⚠ To control the drone with the APP, you must connect your mobile device to the remote controller's Wifi signal, not the Wifi of the drone.

1. Once you have a minimum of 9 GPS satellites, you can unlock the drone and start flying with the remote controller or click the "takeoff" button on the APP, set the take off altitude and then slide to unlock, the drone will ascend automatically and hover.

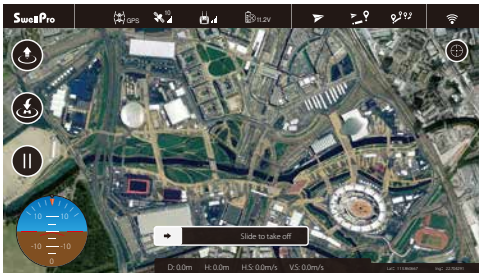
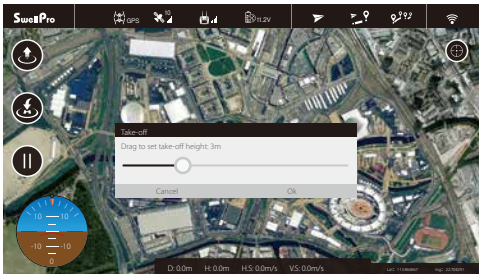

The APP allows you to set hover, return home, flight paths, follow me, tap to fly, etc.

2. Tap-to-Fly: Click the "Point to fly" button, and then click the target points on the map and click the Upload button. The drone will start flying to the point and hover there. If you need to set the parameters manually, you can tap on the flight point.

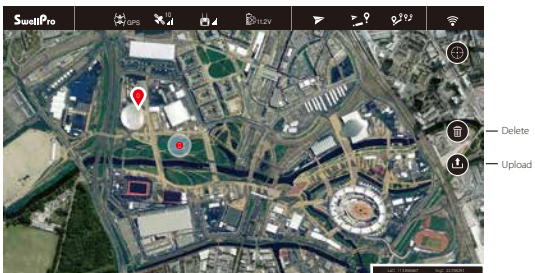

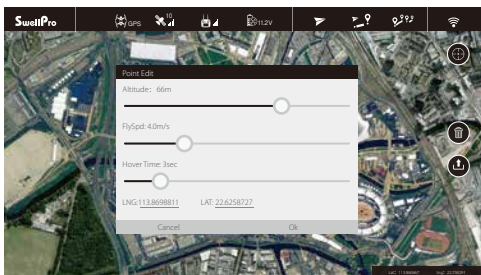

3. Flight Path Setting

- a. Tap the "Flight Path" button at the top of the screen and tap the map to set the flight path (double tap the flight point to delete it, tap the "Delete" button to delete all flight paths). Tap the flight point again to edit.
- b. After completing the setup, click the "Upload" button and the drone will fly according to the flight path.

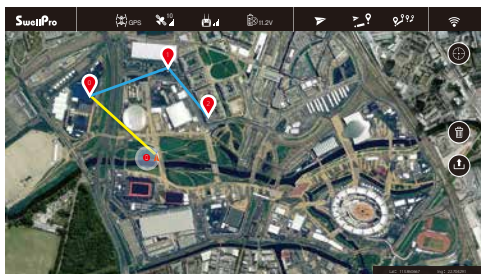

⚠ APP control requires a good wireless communication environment. If the drone does not execute the operation command, this may be due to interference, please try again.

⚠ If the drone continually fails to respond to your APP commands, please operate the drone with the remote controller: quickly switch the Flight Mode switch once, it is suggested to use the GPS mode to take over control.

Flight Safety

1. According to provisions of the International Civil Aviation Organization and many national air traffic regulations, drones must be operated in specified airspaces. The Spry is configured to not exceed an altitude of 200m and a distance of 800m from the remote controller.
2. During flight, try to maintain line of sight with the drone, keep away from obstacles and people.
3. Many regulations require the pilot to fly a drone within line of sight. Take particular care when flying a drone out of sight.
4. Unless it is an emergency, NEVER Lock or STOP the motors in flight as this will cause the drone to fall to the ground and crash.
6. If any obstacles are in the flight path of the drone during a Return Home process, control should be regained by turning off the Return Home function.
8. When taking-off & landing from water, avoid high-speed or abusive landings to avoid damaging the drone.
9. Please make sure you have a comprehensive understanding of the Spry and all the necessary measures required to implement a successful return home function in the event of an emergency.
10. Please be well prepared before each flight; avoid any violent or excessive operations.
11. Please maintain strict compliance with the local laws, any flying in NO-FLY ZONES is prohibited.
12. Any invasion & violation against another person/s right of privacy is not allowed. Before using this product, it remains the duty of the drone pilot to comply with the local laws.
13. Avoid flights in or around strong magnetic fields. This includes wireless electricity emission towers, high-voltage transmission lines, transformer substations, radar towers and other magnetic sources or metal objects.
14. DO NOT fly the Spry under the influence of alcohol, drugs or any other physical or mental impediment.

Flight Restrictions

According to provisions of the International Civil Aviation Organization and many national air traffic regulations, drones must be operated in specified airspaces.

The Spry is configured to not exceed an altitude of 200m and a distance of 800m from the remote controller.

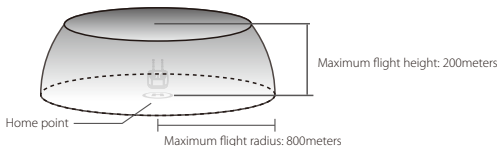

 The safety fence applies in all flight modes.

Battery

Battery Use

1. Do not allow the batteries to come into contact with any kind of liquid.
2. Do not leave batteries out in the rain, or near a source of moisture. If the inside of the battery comes into contact with water, chemical decomposition may occur, potentially resulting in the battery catching fire or exploding.
3. Never use or charge swollen, leaky or damaged batteries.
4. The battery can be used in temperatures ranging from 0°C to 40°C. Use of the battery in environments above 50°C can lead to a fire or explosion. Use of the battery below 0°C might lead to permanent damage.
5. Never disassemble or penetrate the batteries with sharp tools, otherwise, this may result in the battery catching fire, or even lead to an explosion.
6. Electrolytes in the battery are highly corrosive. If any electrolytes make contact with your skin or eyes, immediately wash the affected area with fresh running water for at least 15 minutes, and then see a doctor immediately.
7. If the battery falls into water, pick it up immediately and put it in a safe and open area. Maintain a safe distance from the battery until it is completely dry. Never use the battery again, and dispose of the battery properly as described in the Battery Disposal section below.
8. Do not heat batteries. A battery fire can be extinguished using sand or a dry powder fire extinguisher.
9. Do not put batteries in a microwave oven or in a pressurized container.
10. Do not put any conductive cables or metal objects together with batteries, where they may short-circuit against each other.
11. Do not drop or strike batteries.
12. Do not continue to fly the drone after the low battery alarm has been activated; this will result in over-discharging the battery, and potentially could damage the battery cells.

Battery Charging

1. Always use a Swellpro approved charger to charge the battery of the drone. Swellpro takes no responsibility if the battery is charged using a non-Swellpro charger.
2. In order to avoid any potential accidents happening, please do not leave the battery charging unattended.
3. Do not charge the battery near flammable materials, or on flammable surfaces, such as carpet or wood.
- 4. Do not charge battery immediately after flight, because the battery temperature may be too high.**
5. Disconnect the charger when not in use. Examine and maintain the charger regularly.

Battery Storage and Transportation

1. Keep batteries out of the reach of children and pets.
2. Do not leave the battery near heat sources, such as a furnace, heater, or exposure to strong direct sunshine, for example: in cars.
3. The ideal storage temperature is 22°C ~ 28°C.

4. Keep the battery in a dry and ventilated environment.
5. Never drop the battery into water, or store it in places where there is a possibility of water leakage.
6. Do not drop, strike, impale, pierce, or manually short-circuit the battery.
7. Keep the battery away from metal objects, such as watches, jewellery, and hairpins.
8. Never transport a damaged battery, or a battery with power level higher than 50%.

9. Discharge the drone battery to ~50% before transportation. (The suggested storage voltage level of the drone is ~12.1V, and the radio controller is 50%)

Battery Maintenance

1. Never use the battery when the temperature is too high or too low.
2. The ideal storage temperature is 22°C ~ 28°C.
3. Discharge the power to ~50% (12.1V) when you are not going to use the drone in the coming days.
4. During long term storage, the batteries needs to be checked and charged back to ~50% (12.1v) every 3 months
5. Never over discharge the battery, otherwise the battery cells will be damaged.
6. Do not charge battery immediately after flight, because the battery temperature may be too high.

Maintenance

1. When flying over water, avoid allowing the drone to drop or crash into the water from a high altitude as this could cause major damage to the drone.
2. Don't expose the drone & battery to direct sunlight for sustained periods of time as this can raise the internal temperature of the drone to well above the operating temperature range
3. Please check propellers before each flight. Distorted or damaged propellers should be replaced immediately.
4. After flying over the sea, sand or water, the Spry drone and remote controller must be thoroughly washed with fresh water within 2 hours and dried - especially the motors.
5. It's strongly advised to rinse the drone before the salt crystalizes. * Salt remaining on the waterproof membrane affects drone performance and may cause a crash.
6. Motors are best rinsed by removing the propellers and immersing the motors one at a time into a bucket of warm water and arming the drone so the motors spin.
7. In the event of the Spry not being used for a long time, please store the drone and the batteries in a dry, and ventilated environment at 20°C~25°C.
8. Please refer to <Batteries> for further details on maintaining the batteries.

Troubleshooting

1. Since the Spry and remote controller are completely sealed, occasionally condensation may form on the inside of the glass dome and remote controller screen. This is a normal effect due to changing temperatures and humidity.
 - If a mist forms on the inside of the drone camera dome you can either 1)open the battery cover to let the air inside the drone equalize, or 2)carefully remove the glass dome by releasing the two retaining screws and let the drone and dome dry in a dry environment.
 - For the remote controller, open the USB plug seal in a dry environment and this will allow the moist air to dissipate.
 - If these conditions persist, it is recommended to store the aircraft with the battery door removed and the remote controller with the USB plug open in a box with moisture absorbing crystals available from hardware stores.

Disclaimer and Warning

This product is not a toy, and should only be operated by persons over the age of 15. Please keep it out of reach of children, and pay particular attention to the possible scenarios of children's unexpected appearance during flight operation.

Be sure to read this document carefully before using the product, to fully understand your legal rights, responsibilities and safety instructions. Failure to do so, may cause property damage, safety accidents and personal safety risks. Once this product is used, it is deemed that you have understood, recognized and have accepted all the terms and conditions of this statement. The user is responsible for all the consequences of his actions and consequences. The user agrees to use the product for his sole & legal purpose, and agrees with the terms & conditions of this agreement, and other relevant policies & guidelines that may be specified by SwellPro.

Under the maximum permission by law and approved circumstances, SwellPro is exempt of liability for any indirect, punitive, consequential, special or criminal damages, including the purchase cost, or for loss of income due to the loss of use of the drone.

SwellPro is exempt from the user's liabilities for damage(s) to person/s or property, or injuries incurred directly or indirectly from the use of this product in the following conditions:

1. Damage or injuries incurred when the user/s are under the influence of alcohol, drugs or medication.
2. Any malfunction caused by operators' failure to follow the guidance of the manual to assemble and set up or operate the drone as described and designed.
3. Damage or injuries that may occur due to failure to study the tutorial videos and the user manual before flying the drone.
4. Damage or injuries caused to a person/s or property due to failure in correctly calibrating the drone as outlined in the manual prior to flight.
5. Damage or injuries incurred as a result of the use or installation of any unauthorized third party accessories or counterfeit parts - which were not provided and approved of by SwellPro.
6. Damage or injuries as a result of flying the drone out of eyesight range, or more than 300m away from the controller.
7. Damage or injuries caused by flying the drone in areas of magnetic fields & radio interference.
8. Damage or injuries caused by flying in a NO-FLY ZONE that is regulated by local laws & rules.
9. Damage or injuries including crashes, loss of control or water ingress caused by abusing or modifying the original drone structure,
10. Damage or injuries caused by using broken & ageing components.
11. Damage or injuries caused by continuing to fly the drone even if the low battery alarm is activated.
12. Damage or injuries caused by failure to wash the components with fresh water after flying over or near the sea & corrosive waters.
13. Damage or injuries that have occurred when the drone has been subjected to the following conditions or situations: collision, fire, explosion, floods, tsunamis, ice, snow, avalanche, flooding, landslide, earthquake, etc.
14. Damage or injuries incurred by intentionally dropping or crashing the Spry into the water from a high altitude, especially water ingress into the drone fuselage.
15. Damage or injuries incurred by intentionally dropping or crashing the Spry to the ground or water from a high altitude, especially water leakage into the drone fuselage as a result of this collision.
16. Any invasion & violation against another person/s right of privacy is not allowed. Before using this product, it remains the duty of the drone pilot to comply with the local laws regarding privacy protection.
17. Any invasion or flying over another person/s property is not allowed, please agree with any person/s regarding any potential breach of privacy before the proposed flight.

18. Avoid flights in or around the strong magnetic fields. This includes wireless electricity emission towers, high-voltage transmission lines, transformer substations, radar towers and other magnetic sources or metal objects.
19. DO NOT fly the Spry under the influence of alcohol, drugs or any other physical or mental impediment.
20. Please don't fly the drone with a malfunctioning radio controller - Please fly the drone away from crowds.
21. Other Damage(s) or injuries that are not Swellpro's liability.

Appendix

Specifications

Drone

Waterproof Level	Surface Buoyant
Axis Diameter	270mm
Size (Length x width x height)	233.5 x 249 x 90mm
Weight	538g (Battery excluded)
Brushless Motors	2206 1400KV
Brushless ESC	30A
Propellers	#6045
Battery	3S 3600mAh LiHV battery
Battery weight	220g
Charging Time	About 90mins
Image Transmission Channels	5.8G 8CH
Image Transmission Range	~500m
Flight Time	15-17mins
Max Flight Range	800m from remote controller
Max Flight Altitude	200m
Max Flight Speed	18m/s
Max Ascend Speed	3m/s
Max Follow Me Speed	10m/s
Positioning	GPS/GLONASS
APP Control	Automatic takeoff, automatic hover, automatic return home, point to fly, circling flight, flight path setting, camera control
Hovering Accuracy	±0.5m
Wind Resistance	>10m/s
Working temperature	-10 C -40 C

Remote Controller	
Surface Buoyant	Surface Buoyant
Weight	500g (Battery included)
Frequency	2405-2475HMZ
Control Range	800m
Receiving sensitivity	(1%PER)-105dbm
Working Current	120 mA
Battery Capacity	2S 2000mAh LiPo
Charging Time	About 90mins
FPV Monitor	
Frequency band	5645-5965HMZ
Image reception channels	8
Screen Size	4.3inches
Resolution	800X480Pixels
Brightness	600 cd/m
Camera	
Image Sensor	1/2.3" CMOS, 12M
Lens	F4.53mm f / 2.65
Angle	92.6°
ISO Range	100-1600
Picture Resolution	12MP (16: 9)
Video Resolution	3840 * 2160 30P · 2704x1524 30P · 1920 * 1080 30P / 60P / 120P · 1280 * 720 240P
Max Video Bit Rate	64mbps
Picture Format	JPEG
Video Format	MOV MP4
Storage	Class 10 or UHS-1 and above specifications Micro SD card with max 64GB

Warranty Information

Please visit the Swellpro website to find out the latest information on:

Swellpro After-sales service policy:

Swellpro Maintenance service policy:

Note: When you receive the drone, please register your warranty on our official support page (<https://www.swellpro.com/service.html>) to register and activate the warranty (This is very important; it will ensure your drone is covered by the after-sales terms in the warranty period).

Version Information

SwellPro products are constantly being improved. Therefore, although the latest version of this manual may contain information relating to a release of the equipment different from your own, new information is added constantly which is relevant to ALL customers.

Version	Comments
1.0	Pre-release Manual for Spry
2.0	New Manual for Spry
2.4	Updated details of USB charging and Gyroscope Calibration
2.6	Added IMU Calibration and Page Reflow, Camera control
2.8	Added Low Temperature Flight Warning
2.9	Added APP Control Warning
2.91	Added use the APP to locate the last coordinates to retrieve the aircraft
2.92	Added SPRY Camera Firmware Update Instruction
2.93	Updated Return Home
3.0	Consolidate changes - various clarifications
3.1	Updated FLIGHT BATTERY -Safety Guideline
3.2	Updated Return Home
3.3	Consolidate changes
3.4	Re-check the calibration content
3.5	Re-check the Flight Modes
3.6	Consolidate changes
3.7	Updated Installing and emoving the propellers
3.8	Added introduction of Flight Test Near and On Water Surface
4.1	Consolidate changes and clarifications
4.2	Add "Circle & Follow" mode, correct some description errors



User Manual
2019.8