

# SplashDrone 4

## User Manual



**SwellPro**

Visit [support.swellpro.com](https://support.swellpro.com) for the latest version of this manual and firmware updates for your drone and accessories.

v2.3.2 – September 2022

## Thank You

Thank you for purchasing the SplashDrone 4. We have designed and manufactured the SplashDrone 4 to the highest quality standards.

Like any marine equipment, long-life and trouble-free operation rely on correct care and maintenance. With proper care and maintenance, you should enjoy your drone for many years. After flying in salt or contaminated water, always thoroughly rinse your SplashDrone 4 in freshwater immediately after use or before salt and sediment can dry inside moving parts.

It is important to familiarize yourself with the features of this unique drone by carefully studying this manual and particularly the priority sections indicated in the Table of Contents.

Visit [www.swellpro.com](http://www.swellpro.com) for the latest manuals, software, and tips. Refer to the Version Information section at the end of this manual, which details additions and corrections to this manual.

## Using this Manual

This document is designed to be printed or viewed on a computer or mobile device. If used electronically, you can search directly for terms like "Propeller" to find references. Additionally, you can click on any topic in the Table of Contents to navigate directly to that topic.

## FAQ

The user manual is the best companion while using the product. For the specific problem using the product, the FAQ can be another great resource for you to look at. Go to the SwellPro website, look for support >product support > the product > FAQ to find the FAQ page.

[support.swellpro.com](http://support.swellpro.com)



## Video Tutorials

Visit and subscribe to the SwellPro YouTube channel for tutorial videos and product information. Scan this QR code with your camera phone to go to our channel.



## SwellPro Community

Join our exclusive SwellPro Community to post feedbacks and share your experience with SwellPro products to other users like you.

<https://support.swellpro.com/hc/en-us/community/topics>

## Social Media

Join our Facebook page to meet other people who share their adventures with SwellPro. [www.facebook.com/SwellPro/](http://www.facebook.com/SwellPro/)



## Register Product Warranty

Please register your product to ensure warranty coverage.

[www.swellpro.com](http://www.swellpro.com) > support > register your product

## Download the SDFly App

Get the most from your SplashDrone 4 by flying with the SDFly App. It's available on both the App Store and Google Play store. You can also download the App on our support website: [support.swellpro.com](http://support.swellpro.com).

**There are 2 SDFly Apps, SDFly App and SDFly 2 App. Please use the SDFly App. ONLY use SDFly 2 App if you want to use the MP1 Megaphone. To use the SDFly 2 App, you need to update to a specific set of firmware, please contact us by submitting a request on our support website: [support.swellpro.com](http://support.swellpro.com), we will guide you through the way and provide you the set of firmware.**



# Contents

Thank You	2
Using this Manual	2
FAQ	2
Video Tutorials	2
SwellPro Community	3
Social Media	3
Register Product Warranty	3
Download the SDFly App	3
<b>Contents</b>	<b>4</b>
<b>Product Overview</b>	<b>8</b>
Aircraft Diagram	9
Remote Controller Diagram	10
Remote Controller Screen	11
Install the Aircraft	12
Install Propellers	12
Install the Intelligent Battery	13
Install the Camera/Accessories	14
<b>Aircraft</b>	<b>15</b>
Aircraft Status Indicator	15
Intelligent Battery	16
⊠ Battery Warning	18
Low Battery Warning	19
Aircraft Antenna	20
Antenna Position	<b>Error! Bookmark not defined.</b>
Antenna Blind Spot	21
Strobe Light	22
Waterproof Barometric Membrane	22
<b>Remote Controller</b>	<b>24</b>
Using the Remote Controller	24

Power ON/OFF	24
Flight Mode Switch	24
Joystick Controls	24
Camera Control	25
Gimbal Control	25
Follow Me	26
Return to Home (RTH)	26
Smooth+ Controls	26
BOAT Button	27
Gimbal Button	27
Payload Button (Left)	28
Payload Button (Right) / Slow Mode	28
Remote Control Antenna	28
Optimal Signal Transmission	28
Patch Antenna	28
Attach Mobile Devices	30
Charging the Remote Controller	30
Pairing the Remote Controller	30
About Pairing	30
Identify SN Number	31
For SN number ending with V01	32
For SN number ending since V02 (V02, V03, V04 ... etc)	33
Remote Controller Rear Ports	34
<b>Flight</b>	<b>35</b>
Flight Safety and Environment	35
Flight Restrictions	36
Pre-Flight Checklist	36
Compass Calibration	37
Gyroscope Calibration	38
IMU Calibration	39
Basic Flight Steps	40
Starting/Stopping Motors (Arming the Drone)	41

Water Takeoff and Landing	42
Boat Takeoff and Landing	42
Power Flip	43
Flight Modes	43
Intelligent Follow	46
Smooth+	47
Dynamic Return to Home (RTH)	47
Low Battery Auto Return to Home	48
Low Battery Auto Payload Release	49
<b>SDFly App</b>	<b>50</b>
Download SDFly	50
Connect SDFly	50
Use Mobile Data	50
Home Screen	51
Main Interface	52
Map Interface	53
Set the Wi-Fi Password	54
Set the Wi-Fi Password	54
Reset the Wi-Fi Password	54
<b>Appendix</b>	<b>56</b>
Specifications	56
Firmware Update	58
Flying Guide	58
Joystick Calibration	59
Warranty Information	60
Battery Care and Maintenance	60
Precautions for low-temperature use	61
Battery Charging	61
Battery Storage and Transportation	61
Battery Disposal	62
Maintenance	62

Disclaimer and Warning	62
Version Information	63

## Product Overview

SplashDrone 4 is our 5th and the latest generation of waterproof drones, representing SwellPro's 7 years of knowledge and understanding of drone waterproofing technology.

SplashDrone 4 is the all-new waterproof flight & float platform designed for multipurpose operation in any harsh environment. With its modular payload system design and our variety of payload choices, the SwellPro SD4 can quickly adapt to different tasks in the field.



# Aircraft Diagram

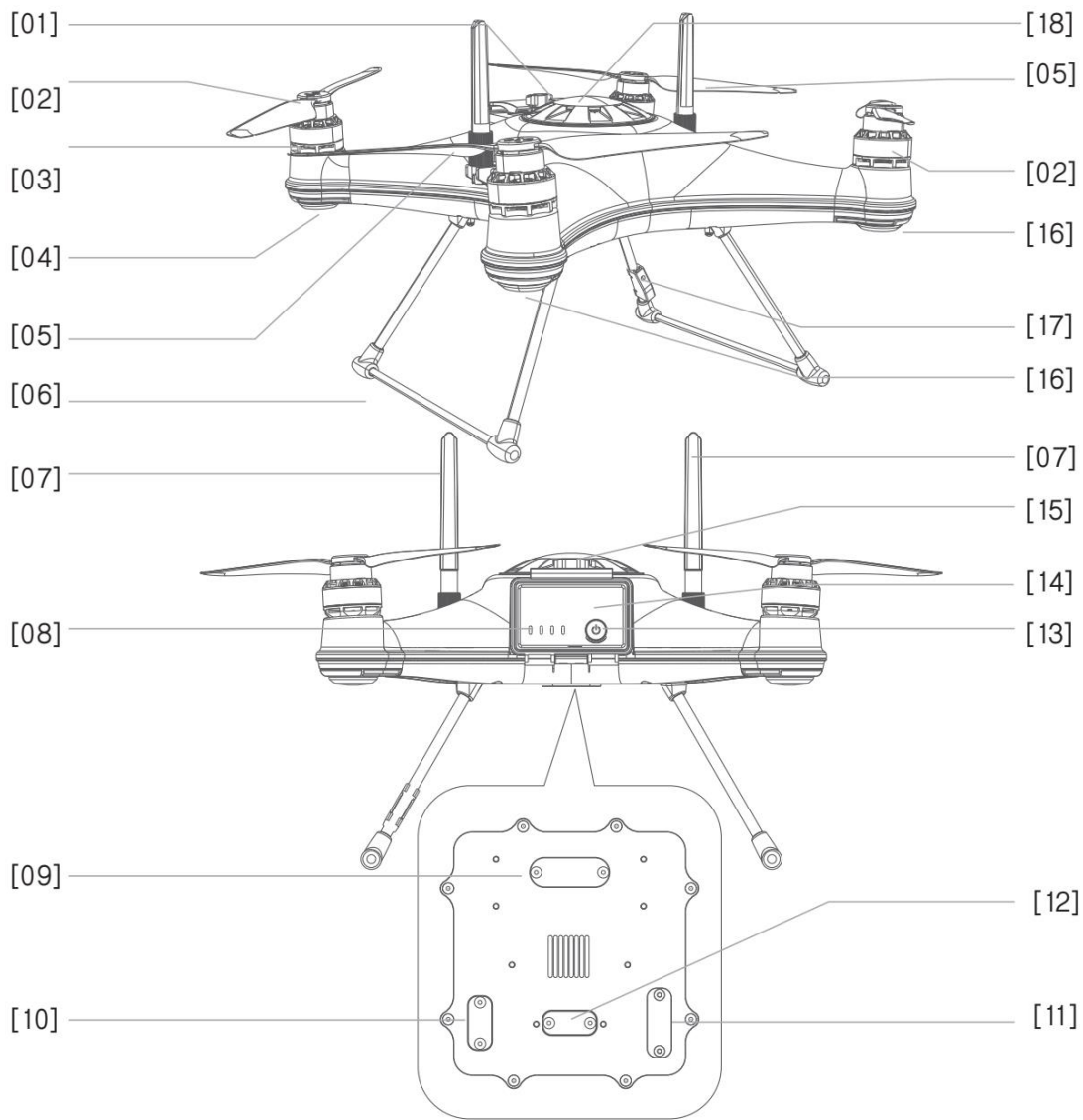

- |  |                                  |
|--|----------------------------------|
| [01] Strobe Light                      | [02] CW (clockwise) Propeller    |
| [03] Waterproof Motor                  | [04] Rear Arm Light              |
| [05] CCW (Counter-clockwise) Propeller | [06] Landing Gear                |
| [07] Antennas                          | [08] Battery Status Indicator    |
| [09] Gimbal Camera Port                | [10] Payload Release Port        |
| [11] SDK Port                          | [12] USB Port and Pairing Button |
| [13] Power Button                      | [14] Battery Hatch               |
| [15] Battery Hatch Lock                | [16] Front Arm Light             |
| [17] Compass Sensor                    | [18] GPS Cover                   |

## Remote Controller Diagram

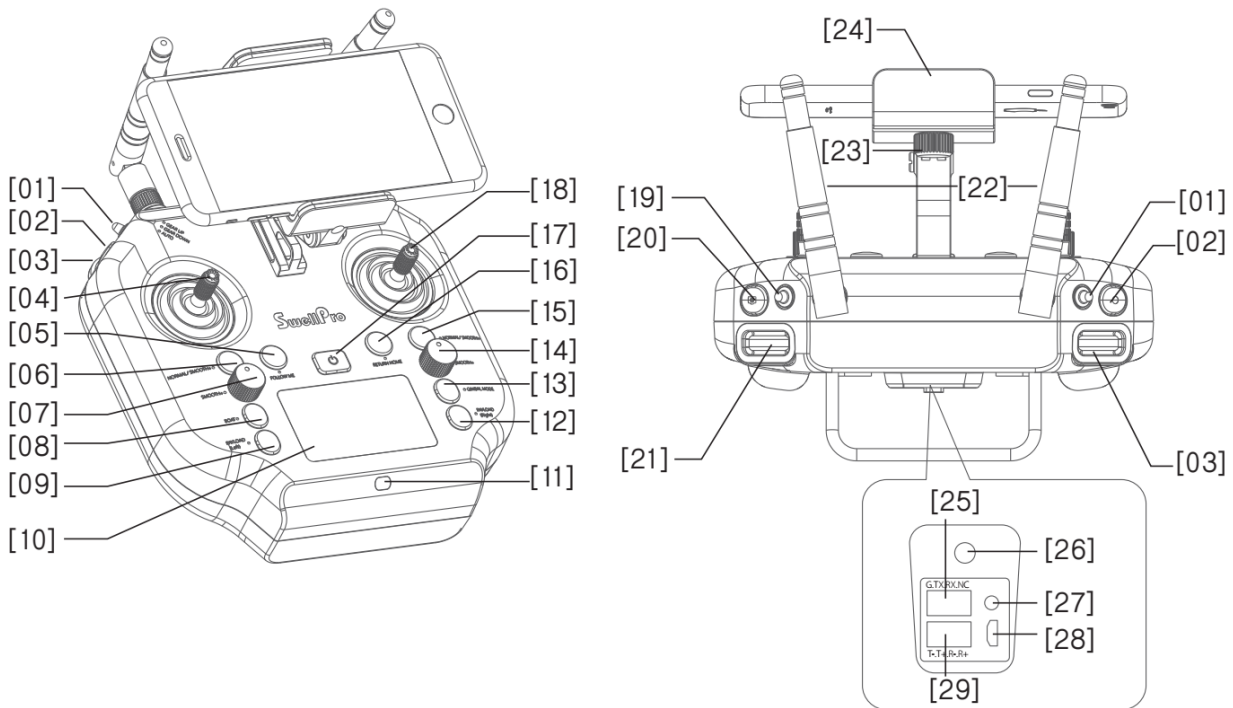

[01] Automatic Landing Gear Toggle (Not Applicable)

[03] Gimbal Pan/Tilt Roller

[05] Follow Me Button

[07] Smooth+ Yaw Knob

[09] Left Payload Release Button

[11] Charging Indicator

[13] Gimbal Mode Switch Button

[15] Smooth+ Roll Switch Button

[17] Power Button

[19] Flight Mode Toggle

[21] Gimbal Pitch Roller

[23] Phone/Tablet Mount Adjustment Knob

[02] Video Button

[04] Left Joystick (Throttle/Yaw)

[06] Smooth+ Yaw Switch Button

[08] Boat Mode Switch Button

[10] Display Screen

[12] Right Payload Release Button

Slow Mode<sup>1</sup>

[14] Smooth+ Roll Knob

[16] RTH Return Home Button

[18] Right Joystick (Pitch/Roll)

[20] Photo Button

[22] Antennas

[24] Phone/Tablet Mount

<sup>1</sup> For the SplashDrone 4 came out later in 2022, the *Payload (Right)* print changes to *Slow Mode*. Button function stays the same. Check [Remote Controller section](#) for the button function.

- [25] Serial Port
- [27] Pairing Button
- [29] Ethernet Port

- [26] Charging Port
- [28] Micro USB Port

## Remote Controller Screen

The screenshots show the following data points:

- [01] Remote Controller Battery Level
- [02] Remote Controller GPS Status <sup>2</sup>
- [03] Drone Signal Strength/Pairing Status
- [04] Flight Mode
- [05] Drone Battery Voltage (V)
- [06] Aircraft GPS Location Accuracy <sup>3</sup>
- [07] Distance
- [08] Height
- [09] Drone Battery Level
- [10] Horizontal Flight Speed
- [11] Vertical Flight Speed
- [12] Estimated Remaining Flight Time
- [13] PITCH: -36
- [14] TIME: 0.213M
- [15] LAT: +22.6370106
- [16] LNG: +113.9458013
- [17] ROLL: -17
- [18] YAW: -130
- [19] RC: 2473922144
- [20] FC: 2473932146
- [21] S.Ver: 000
- [22] Fly Time: 0Min
- [23] (Empty bar chart)

**Legend:**

- G GPS
- A ATTI
- C Cruise
- H Headless
- R Return to Home
- F Follow Me
- O Orbit
- M Manual
- S Sport
- B Boat

- [01] Remote Controller Battery Level
- [03] Drone Signal Strength/Pairing Status
- [05] Drone Battery Voltage (V)
- [07] Distance
- [09] Drone Battery Level
- [11] Vertical Flight Speed

- [02] Remote Controller GPS Status <sup>2</sup>
- [04] Flight Mode
- [06] Aircraft GPS Location Accuracy <sup>3</sup>
- [08] Height
- [10] Horizontal Flight Speed
- [12] Estimated Remaining Flight Time

<sup>2</sup> The icon flashing indicates the remote controller does not receive the GPS signal. When it receive the GPS signal, the icon will stop flashing.

<sup>3</sup> Aircraft GPS Location Accuracy ranges from 1-10 with 10 being the highest accuracy. A rating of 10 indicates a drone location accuracy <1m. 9=1.1 meters; 8=1.2 meters, 7=1.3 meters, 6=1.4 meters, 5=1.5 meters. In GPS mode, it is recommended to take off with at least 5.

- |   |                                      |
|---|--------------------------------------|
| [13] Pitch Angle  | [14] Flight Time                     |
| [15] Drone Latitude                                     | [16] Drone Longitude <sup>4</sup>    |
| [17] Roll Angle   | [18] Yaw Angle                       |
| [19] Remote controller Serial Number & Firmware Version | [20] Flight Controller Serial Number |
| [21] Flight Controller Firmware Version                 | [22] Total Flight Time               |
| [23] Joystick and Control Input                         |                                      |

## Install the Aircraft

### Install Propellers

The SplashDrone 4 has two pairs of propellers - two clockwise propellers and two counter-clockwise propellers. The hub of each motor shows the type of propeller used for that motor. Propellers should not be attached to the wrong motors.

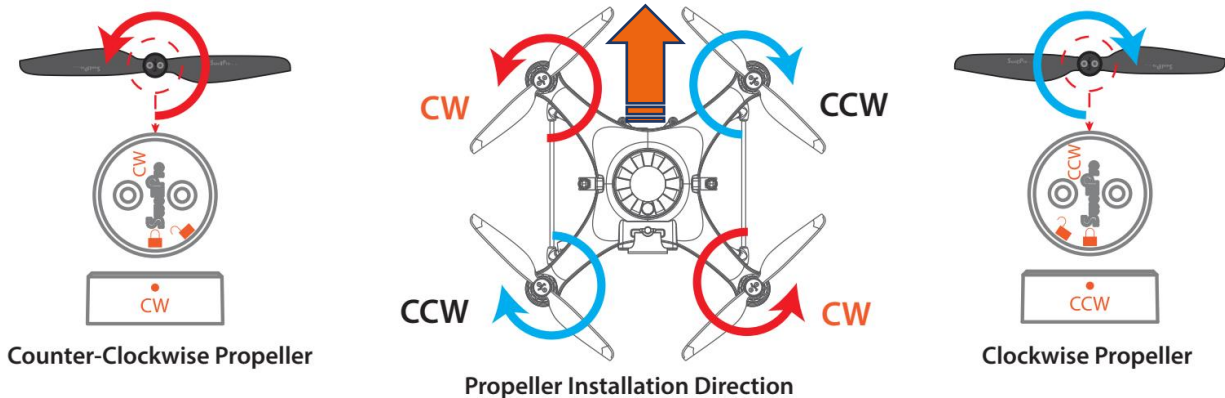

### To install or remove propellers:

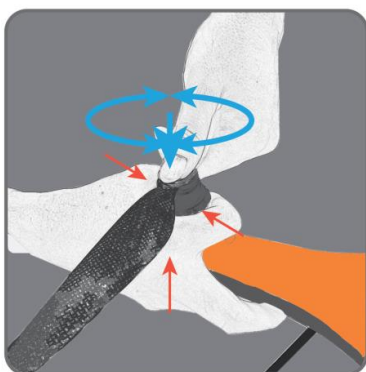

1. Check the propeller's marking (CW/CCW) to see if it matches the motor. CCW propellers to CCW motors, same for CW.
2. Place the propeller on the motor, rotate the propeller in the hub for 1/8<sup>th</sup> of a turn until it engages.
3. Hold the arm of the aircraft tight with one of you hand.
4. Rotate the propellers in the direction indicated by the lock signs with your other hand.
5. To remove the propeller, repeat steps 3&4.

<sup>4</sup> If the signal to the drone is lost for any reason, the remote controller will display the last known location of the drone.

**Always place one hand under the motor to support it when installing or removing propellers. Failure to provide this support could result in bending or breaking the landing gear.**

**The propellers are sharp, please be careful to avoid injury.**

**Do not use broken propellers. Replace the propeller if there is any damage or wear to the propeller.**

**Ensure there is no wobble on the propeller after you install. If you correctly install the propeller, the propeller still wobbles, you might need to tighten the screws on the propeller base.**

**Before each flight, please check that the propellers are smooth all over and are correctly installed and securely fastened. Spin each propeller by hand to check that the motors are free of sand or salt and spin freely.**

## Install the Intelligent Battery

The Intelligent battery is quick and easy to change. Ensure the battery is OFF before inserting or removing it from the drone.

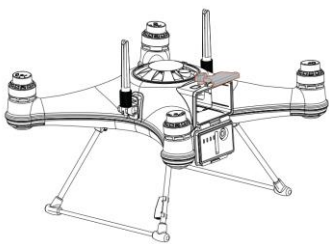

1. Unlock and open the waterproof hatch

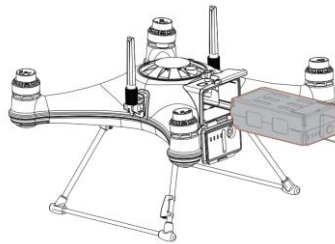

2. Slide in the fully charged intelligent battery and push it firmly into the battery slot.

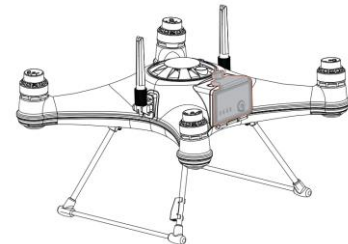

3. Close the battery hatch. Fasten the catch and then lock the hatch.



**When slide in the battery, ensure to firmly press the battery into the battery slot to prevent water ingress.**



**"Beep...Beep" indicates the battery is not fully inserted. Please firmly press it again.**

⚠ Always check to ensure that the waterproof seal on the hatch door is clean and lightly lubricated.

⚠ The drone is no longer waterproof when the battery hatch is open. Do not allow water or sand to enter the drone while the battery hatch is open.

⚠ The Appendix of this manual contains additional warnings and precautions regarding the batteries, safety, charging, and maintenance. Please familiarize yourself with all the information.

## Install the Camera/Accessories

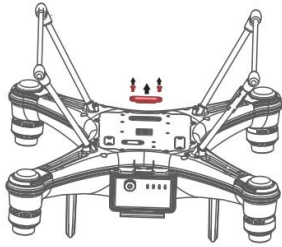

1. Unscrew and take off the gimbal port cover plate using a hex screwdriver. (Equipped with SplashDrone 4)

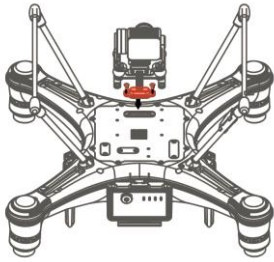

2. Plug the gimbal connector into the drone's gimbal port and screw it in place with a screwdriver.

**! Make sure the rubber ring is attached to the gimbal connector before you screw the connector.**

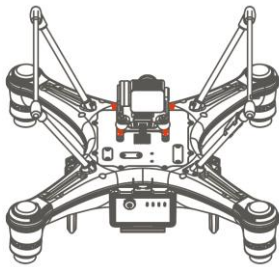

3. Align the holes on the base of the gimbal to the bottom of the drone, screw in to mount the gimbal. Make sure the camera is pointing to the front of the drone.



**Other accessories can be replaced or installed in the same way.**

# Aircraft

## Aircraft Status Indicator

There are two types of aircraft status indicators:

1. Front status indicators (Red).
2. Rear status indicators (Green).

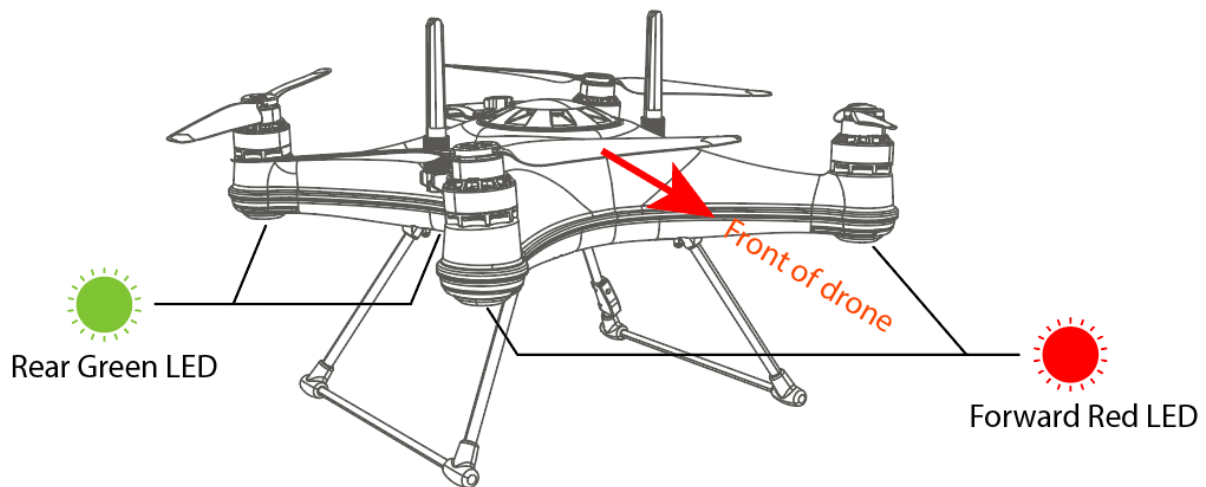

- 💡 The red status indicators are used to identify the head of the drone.
- 💡 All aircraft status indicators can be turned on or off on the App setting.
- 💡 All the status indicator messages are going to prompt on the remote controller screen.



## GPS Status

	Solid Green	Good GPS signal
	Fast Flashing Green	Poor GPS signal

## Low Battery Warning

	Flashing Red 4 times	First low battery warning
	Fast Flashing Red	Second low battery warning
	Flashing Red 3 times	Auto returning home

## Calibration Warning

	Red Green Slow Flashing Together	Compass calibration required
	Fast Flashing Green	Rotate aircraft horizontally
	Slow Flashing Green	Rotate aircraft vertically
	Red Green Slow Flashing Together	Gyroscope calibration required
	Red Green Slow Flashing Together	IMU calibration required
	Red Green Flash Alternatively	Aircraft initializing

## Intelligent Battery

Each slide-in SplashDrone 4 battery has its battery management system, teamed with high-performance 18650 lithium cells to provide up to 30 minutes of flight time.

### The SplashDrone 4 intelligent battery provides:

- Real-time power monitoring and alerting
- Integrated balance charging to ensure battery health, safety, and long life by constantly monitoring battery health, state-of-charge, and temperature.
- Fast, slide-in battery replacement. Integrated connectors allow for wire-free installation and replacement.
- Battery charging and usage data logging to allow for better battery management and event recording.

### Battery Level

The battery level LEDs on the battery pack allow you to check the state of charge of the battery quickly and accurately.

With the Battery turned OFF, short press the power button – the battery LEDs will indicate the state of charge.



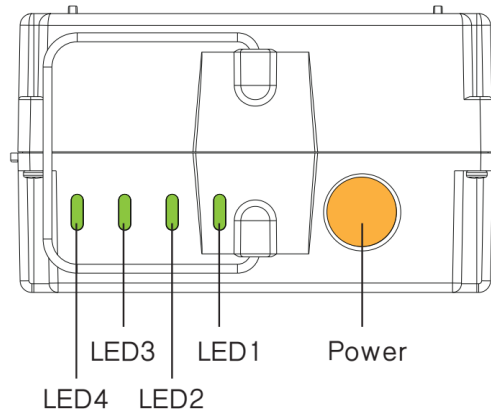

LED1	LED2	LED3	LED4	Battery Level
				88~100%
				76~87%
				63~75%
				51~62%
				38~50%
				25~45%
				13~25%
				0~12%

Solid    Flashing

### Battery Warning Signs

LED1	LED2	LED3	LED4	Battery Warning Type
				Battery Overvoltage Warning
				Battery Undervoltage Warning
				Battery Overcurrent Warning
				Battery Overheating Warning

Flashing

💡 The battery LED might turn yellow when it reaches high current (during the flight or take-off), which it's normal.

### Powering On/Off the Battery

Shortly press the power button once (battery will beep once), then long press the power button for three seconds, battery will beep twice to indicate the battery is turned on. Same for powering off the battery.

## Charging the Batteries

Your SplashDrone 4 is shipped with partially charged batteries. Ensure the drone battery and the remote controller battery are fully charged before use.

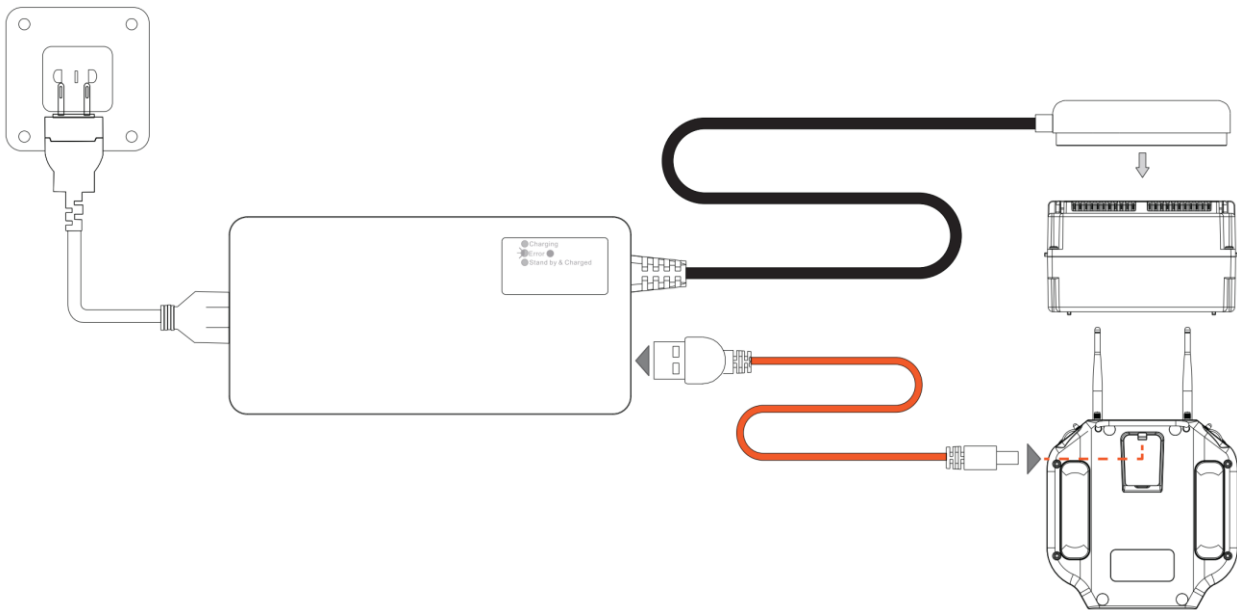

The drone and remote controller batteries can be charged simultaneously using the in-the-box charger.

### How to charge:

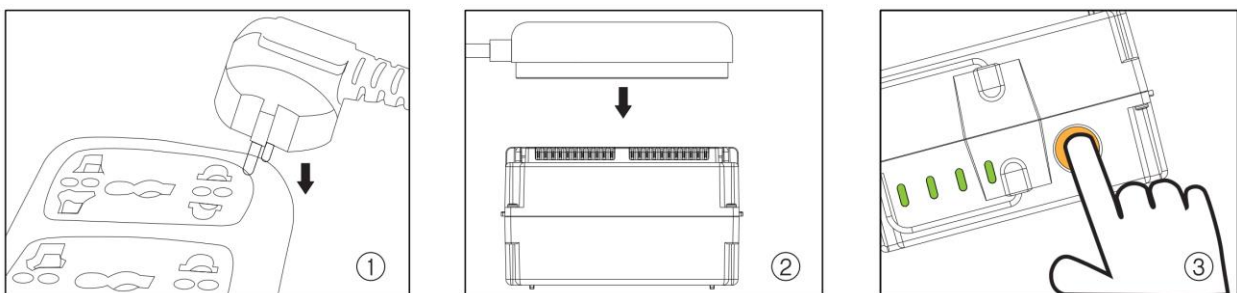

Refer to the above figures to charge the flight battery.

**⚠ The battery needs to be powered on for charging. (Short press the power button once, then long press the power button for three seconds.)**

## **⚠ Battery Warning**

- Keep battery slot **AWAY FROM WATER**. Store battery in a **COOL, DRY** place.
- Do not fly the drone with battery voltage below 12.0 volts.
- Long-term storage voltage: No less than 14.0 volts. Full power storage is the best.
- For more battery care info, check Battery Care and Maintenance section on the Appendix.

**Failure to do so may result in battery catching fire.** SwellPro is exempt from the user's liabilities for damage(s) to person/s or property, or injuries incurred directly or indirectly from the use of this product in this condition.

## Low Battery Warning

The SplashDrone 4 has two low battery warnings to help the pilot manage the drone's battery life. Each time a battery level alarm is activated, the remote controller will beep and vibrate to alert the pilot.

**\*\*\*.WARNING.\*\*\***

**LOW BATTERY**

**Return Aircraft  
and Land**

**\*\*\*.WARNING.\*\*\***

**AIRCRAFT BATTERY  
LEVEL CRITICAL**

**Land Aircraft NOW**

*Level 1 alarm:* The drone battery level has reached 13.0 V. The remote controller screen will prompt "LOW BATTERY; Return Aircraft and Land". The front drone status indicators will flash a pattern of 4 red lights. If low battery auto Return-to-Home is turned on, the drone is going to auto RTH after this low battery warning.

*Level 2 alarm:* The drone battery level has reached 12.0 V. The remote controller screen will prompt "AIRCRAFT BATTERY LEVEL CRITICAL; Land Aircraft NOW".

After 10 seconds, the drone will initiate an in-place auto-landing to protect the drone and battery. The front aircraft status indicators are going to flash red constantly.

During auto-landing, you can control the joystick to overwrite the auto-landing and regain control of the drone. However, flying the drone below 12V is highly dangerous since the battery will not be able to maintain the flight and will result in the aircraft crashing.

**⚠ During the flight, it is important to constantly monitor the battery level as flying in the conditions like strong wind and rapid movements and heavy load can deplete the battery more rapidly.**

**⚠** It is dangerous to continue flying the drone below 12 V. This could result in damage to the battery and the risk of the drone crashing.

## Aircraft Antenna

The antennas of the aircraft can be oriented either upwards or downwards to maximize reception in different situations. The SplashDrone 4 has an effective range of 5 km. Due to the way radio frequency travel, when flying 0.5m above the water, the transmission range reduces to 2.8 km. For the drone floating on the water surface, the transmission range reduces to 500m.

### Antenna Orientation

Adjust the antennas' orientation to ensure a stable connection for your flight. To adjust the antenna position: loosen the antenna nut, adjust the antenna position, and retighten the nut.



**Antenna oriented upward:** Improves reception when the aircraft is flying close to the water surface.



**Antenna oriented downwards:** Improves reception when the aircraft is flying at a high altitude.



**Antenna oriented upward and downward:** Ensure signal connection when the aircraft roll over on water. Use this antenna orientation if you need to land the aircraft on the water during the flight. **Note:** This orientation decreases the connection range in both situations (flying close to water or flying at a high altitude). It's recommended to only use this orientation when you need to land the aircraft on the water.

To adjust the antenna position: loosen the antenna nut, adjust the antenna position, and retighten the nut.

## Antenna Blind Spot

Due to the nature of antenna radiation pattern, there is a blind spot about **40°** under the aircraft. When position under the blind spot area, the remote controller will experience **signal lost**. If you encounter signal lost issue when you are near the aircraft, you might be in the blind spot area.

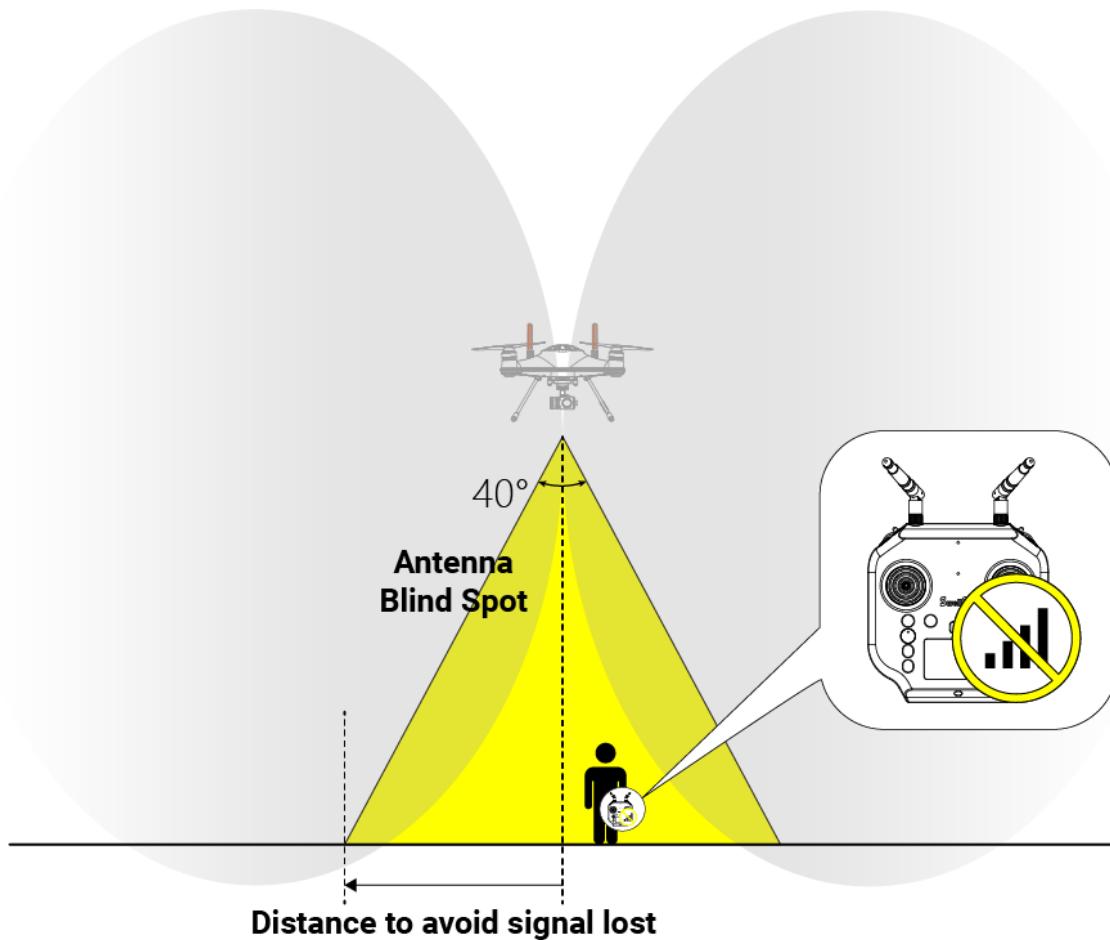

Please avoid being in the blind spot zone to prevent the signal lost issue.

- During take-off, try to fly the aircraft away from you instead of quickly ascending the aircraft into the overhead area near you.
- Same for Return-to-Home/Landing, land the aircraft at a safe distance before you to avoid being in the blind spot area.

Here is the estimated safe distance from the aircraft to prevent signal lost due to being in the blind spot area.

Aircraft Heigh	Safe Distance
10 m	4 m
30 m	11 m
50 m	18 m

80 m	30 m
100 m	37 m
120 m	44 m

💡 If you want to estimate the safe distance, use this equation  $\tan(20^\circ) \times \text{Height}$  to calculate. (Height is the height of the aircraft, which can be obtained from the remote controller or the App)

## Strobe Light

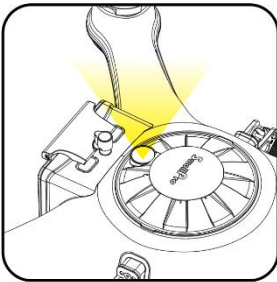

The top of the aircraft is equipped with high-intensity strobe light, which helps identify the drone's position to the pilot and other air traffic. This meets the requirements of night flight regulations in some countries and helps ensure flight safety at night. The strobe can be activated and deactivated in the App (STB).

## Waterproof Barometric Membrane

The waterproof barometric membrane is SwellPro's featured technology. It allows air to pass through the internal chamber of the aircraft to ensure the barometer's proper functioning yet keeps the water from getting in to ensure the SplashDrone 4's all waterproof design. The waterproof barometric membrane is delicate yet an extremely important part for proper flying and waterproofing. Therefore, you should pay special attention to the proper use of waterproof barometric membrane during your operation.

- **Always check the barometric membrane to ensure no damage being observed before flying.**
- **Rinse the barometric membrane thoroughly with freshwater every time after flying.**
- **If you constantly fly your drone in the saltwater environment (sea), it is recommended to change the barometric membrane once every 2 months, since the salt particles can clog the tiny holes on the membrane.**
- **If the aircraft is not flying stably during hovering, or the aircraft is not flying normally during ascend or descend, the barometric membrane might be damage. Please replace the barometric membrane.**
- **If the barometric membrane is damaged or shows signs of wear and tear, replacement of the waterproof barometric membrane is required.**

To replace the barometric membrane:

1. Take out the top cover.
2. Peel off the old waterproof barometric membrane. Clean the surface barometric vent and make sure there is no residue on the surface.

3. Remove the 3M paper from the waterproof barometric membrane and press it firmly on the barometric vent to ensure a tight seal.
4. Put the top cover back.

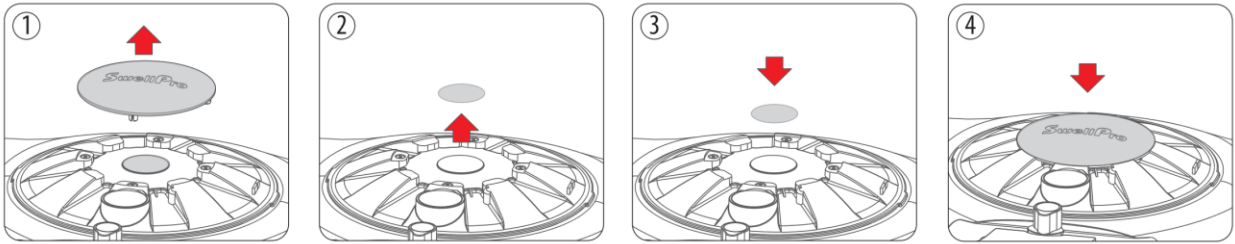

**⚠ Make sure there is a tight seal around the waterproof barometric membrane when applying.**

# Remote Controller

## Using the Remote Controller

⚠ Install the Remote controller antennas BEFORE using or turning the power on. Failure to install the antennas before powering on the remote controller may cause permanent damage to the remote controller. Failure to install the antennas before using may cause antenna ports to oxidate.

### Power ON/OFF

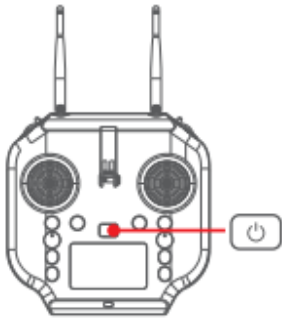

1. Press and hold the Power switch for 3 seconds.
2. The Remote controller will power ON.
3. To turn OFF the Remote controller, return the Camera Control switch to the Preview position to stop any recording.
4. Press and hold the Power switch for 3 seconds. The Remote controller will power OFF.

### Flight Mode Switch

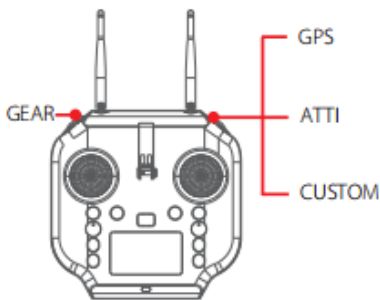

**GPS:** Sets the drone to GPS mode.

**ATTI:** Sets the drone to ATTI mode.

**CUSTOM:** Sets the drone to the user-selected flight mode. This can be set in the App. The default flight mode is Sport mode.

**GEAR:** Not currently supported.

### Joystick Controls

LEFT JOYSTICK controls Throttle & Yaw; RIGHT JOYSTICK controls Pitch & Roll. YAW controls the direction; THROTTLE controls the ascend or descend of the drone; PITCH controls the drone to fly forward or backward; ROLL controls the drone to fly left or right.



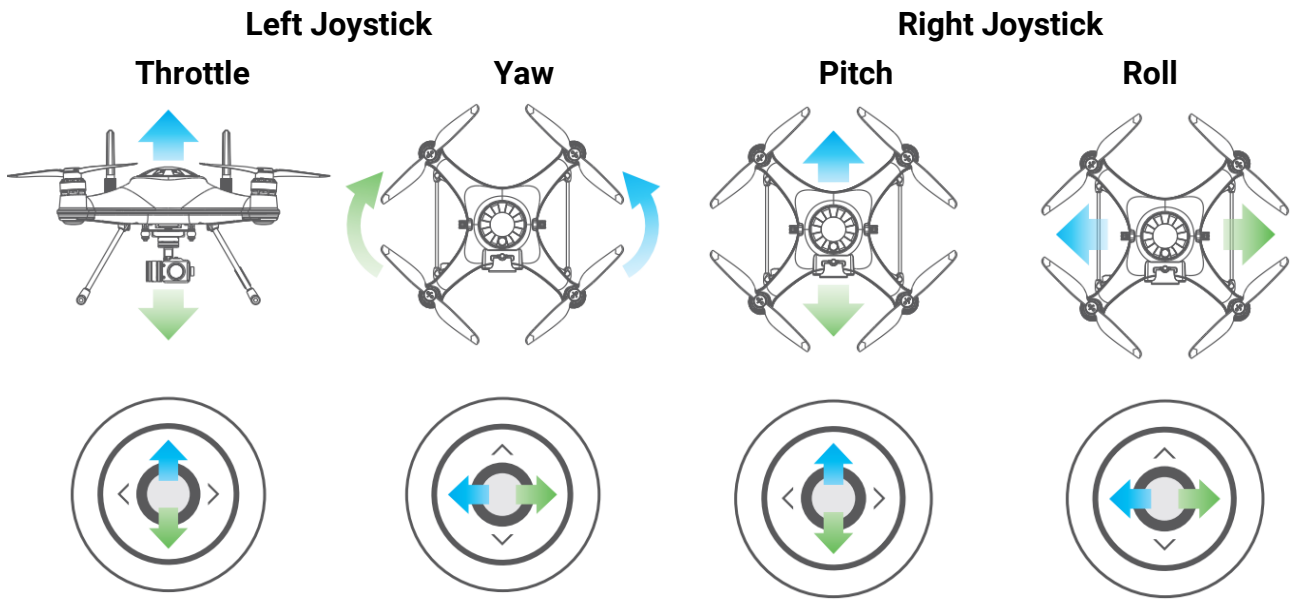

### Camera Control

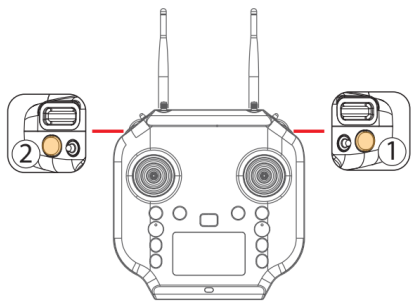
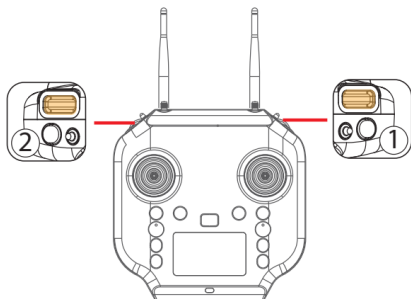

**Photo ①:** Press the photo button to capture photos.

**Video ②:** Press the video button once to start video recording. Press again to stop video recording and save the video file.

**⚠ It is important to stop video recording before powering off the drone.**

### Gimbal Control



**Tilt Control Roller ①:** Control the tilt angle of the gimbal.

**Pan Control Roller ②:** Control the direction of the gimbal.

## Follow Me

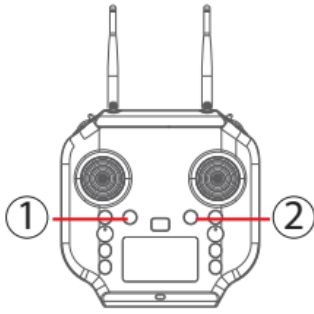

**Start Follow Me:** 1) Check that the remote controller has a GPS signal by checking the GPS status indicator on the screen. (The GPS status icon is not flashing) 2) Press and hold the Follow Me button ① to start Follow Me mode. The remote controller will beep twice.

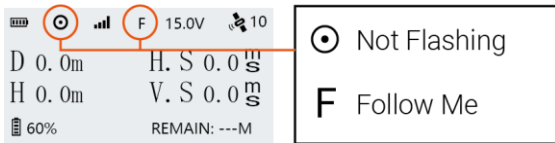

**Stop Follow Me:** Press and hold the "FOLLOW ME" button again until the remote controller beep once to indicate that Follow Me mode is disengaged.

## Return to Home (RTH)

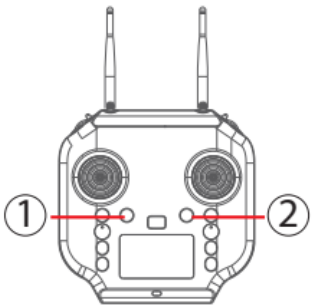

Long press the Return Home button ②, the remote controller will beep and vibrate twice to indicate that the drone will initiate the return to home process. The flight mode indicator on the remote controller status bar will change to the letter "R" to indicate the drone is on the RTH process.

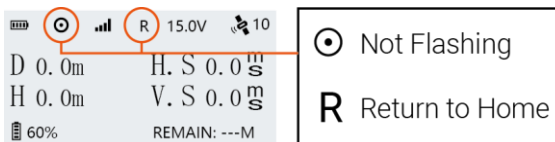

**⚠** If aircraft set to return to remote controller, ensure remote controller has good GPS signal during the entire RTH process. (The GPS status icon is not flashing)

## Smooth+ Controls

The patented "Smooth+" flight control allows the pilot to finely tune the Roll and Yaw of SplashDrone 4. Smooth+ makes professional, steady flight control as easy as turning the knobs.

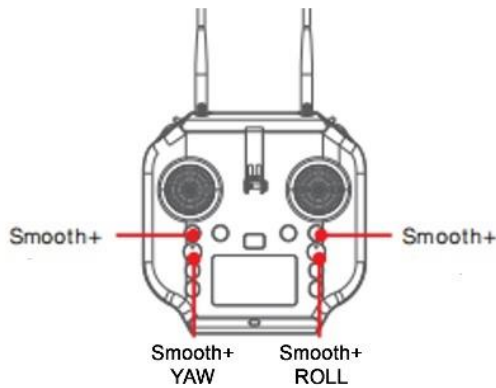

To enter Smooth+ mode, simply press the Smooth+ buttons. **Note: Smooth+ knob need to be in the center position in order to be turned on.**

Press the left Smooth+ button to engage Smooth+ YAW. The left joystick will now only control the ascend/descend of the drone.

Press the right Smooth+ button to engage Smooth+ ROLL. The right joystick will now only control the pitch of the drone.

## BOAT Button

In Boat mode, the SplashDrone 4 can effectively be controlled like a boat on the surface of the water. With a maximum surface speed of 1m/s. **BOAT mode should only be used when the aircraft is equipped with the SwellPro Boat Mode Kit (BKT).**

To enter the Boat mode:

1. Land or place the drone on the water.
2. For landing on the water, lock the drone.
3. Switch the drone to GPS or ATTI mode.
4. Arm the drone by using the inward gesture.
5. Press the BOAT button on the remote controller.
6. The drone now enters the Boat mode.
7. Press the BOAT button again to exit Boat mode. The drone can then take off normally.

## Gimbal Button

There are two gimbal modes: Follow mode and Lock mode. The default mode is Follow mode.

Follow mode keeps the gimbal direction to the head of the drone.

Lock mode locks the gimbal position so the is not going to follow the direction of the drone when the drone is turning.

Press the GIMBAL MODE button once to restore the central position.

Press the GIMBAL MODE for 3 seconds to switch gimbal modes.

💡 Gimbal mode only works for GC3-S and GC3-T.

💡 You can add an extension bar or gimbal overhead kit to take full advantage of gimbal Follow mode and Lock mode.

## Payload Button (Left)

Open: Press the PAYLOAD(Left) button once to open the payload release rod.

Close: Press it again to close the payload release rod.

## Payload Button (Right) / Slow Mode<sup>5</sup>

Press the right Payload (Right) / Slow Mode button 3 times to enter low-speed mode. There is a low-speed mode embedded in all flight modes for a safer flight purpose. (For example, when the drone is equipped with SwellPro Gimbal Extension Bar (GEB), switching to low-speed mode allows the drone to fly more stable and safely.)

## Remote Control Antenna

### Optimal Signal Transmission

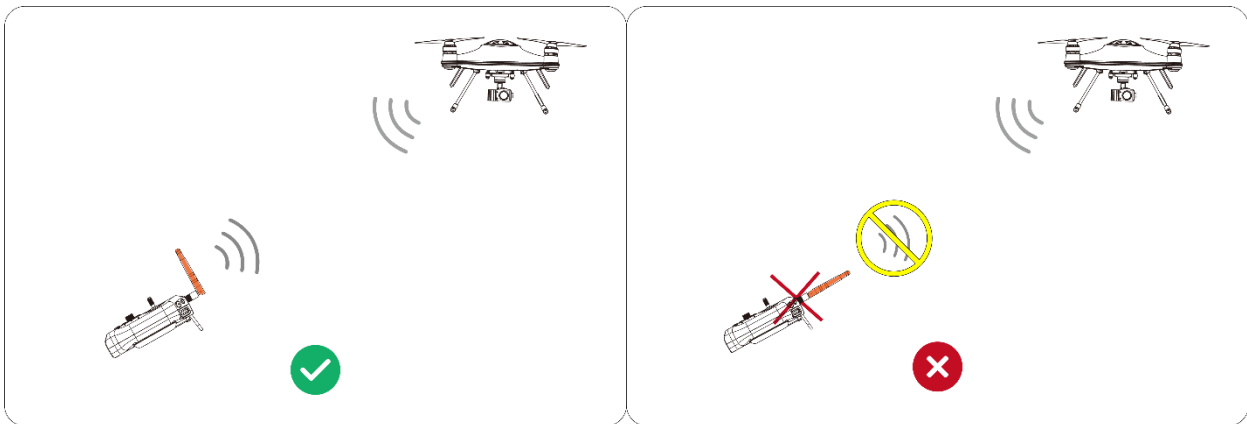

Position the antenna parallel to the aircraft for **optimal signal transmission**.

**DO NOT** point the tip of the antenna to the aircraft. Otherwise, it would result in **signal lost**.

## Patch Antenna

Patch antenna offers high-gain signal transmission allows for better reception. **Switch to patch antenna when you experience frequent signal interruption.**

<sup>5</sup> For the SplashDrone 4 came out later in 2022, the *Payload (Right)* print changes to *Slow Mode*. Button function stays the same.

## Install

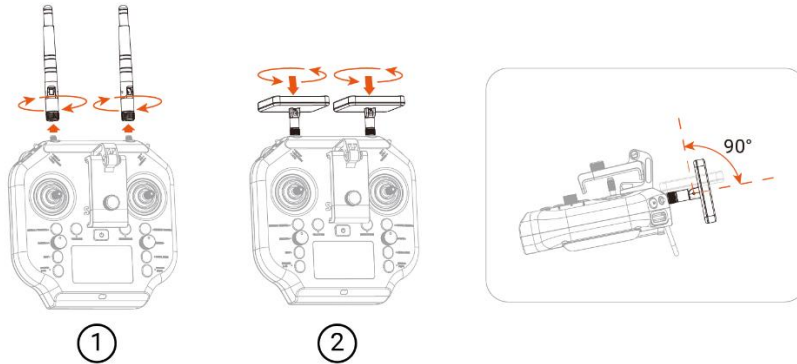

## Use

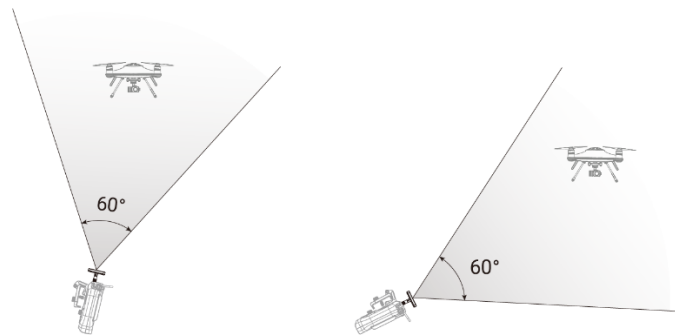

**Always point the patch antenna to the aircraft. Any angle greater than 60° can cause signal interruption.**



*"Signal Interrupt"* will prompt up on the remote controller if the transmission signal is weak. Adjust the angle to the aircraft to make sure the aircraft is in optimal transmission range.

Be aware of surrounding wireless devices or metal objects, as they will affect the transmission signal stability.

Ensure to power off the remote controller before removing or installing the antenna.

Ensure to tighten the antenna to prevent water ingress while using.

## Attach Mobile Devices

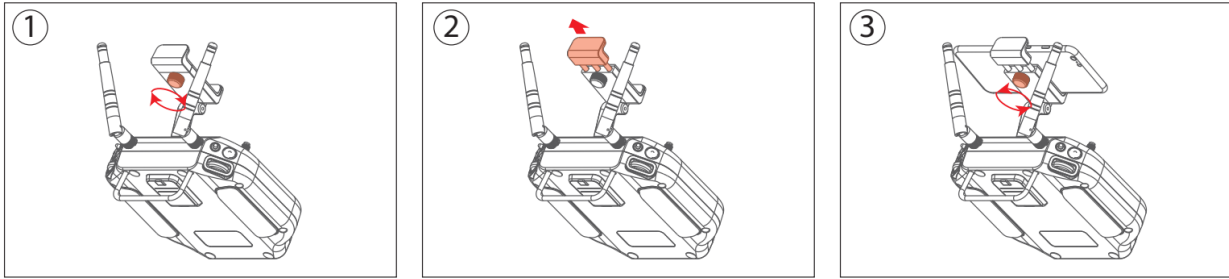

To attach your mobile device to the remote controller:

Release the tightening knob behind the mobile device mount, then slide open the mount to accommodate your device, retighten the knob to secure your mobile device.

💡 There is a larger mobile device mount specific designed for the use of tablets. Visit SwellPro website for more information.

## Charging the Remote Controller

The remote controller can be charged from the in-the-box charger or a standard 5V USB adapter. Recommend using **5V/2A** USB adapter.

The LED light on the remote controller will turn **red** while charging. When the remote controller is fully charged, the LED light will turn **green**.

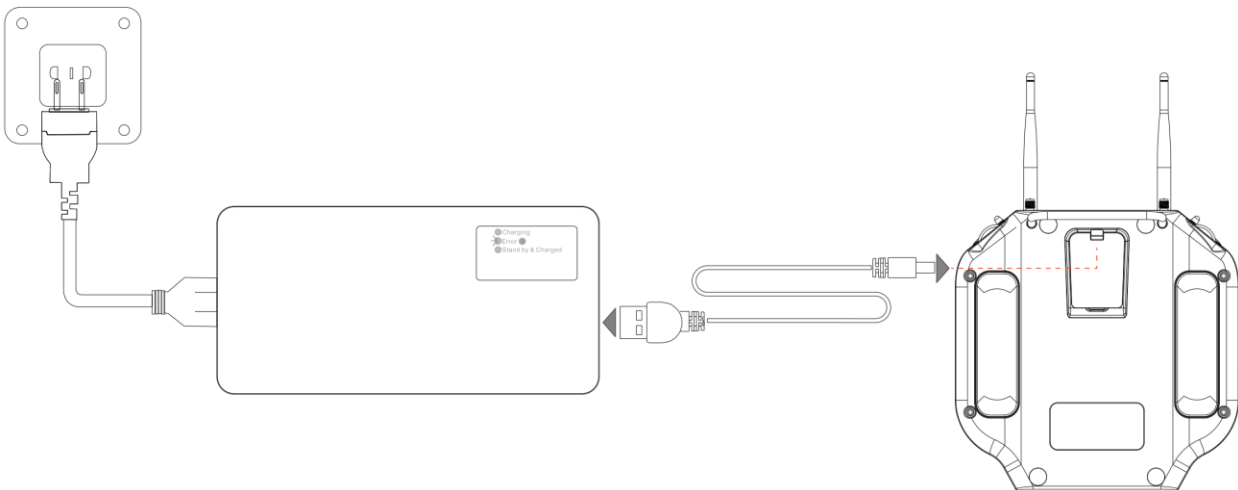

## Pairing the Remote Controller

### About Pairing

The remote controller and the aircraft are paired at the factory before shipping. There is **NO NEED** to pair them for your first use. After turning on, the aircraft and the remote

controller will pair in **2 minutes**. It might take extra time to pair depending on the signal interference of the environment.

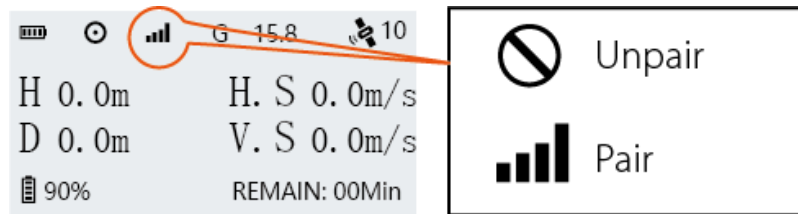

**! ONLY** pair the remote controller for the following condition: After turning on the aircraft and the remote controller for more than 5 minutes, the remote controller signal status bar still shows the Unpair sign.

To ensure the pairing process is successful:

- Please strictly follow the steps to pair.
- Please ensure that you are able to see the light indicator at the bottom of the aircraft. If you can't see the light indicator, please take off the bottom plate so that you are able to see it.
- Please use a timer to count the time needed to press the pair button.

💡 The pair button is delicate. Press the pair button gently to prevent unexpected damage to the button.

---

## Identify SN Number

Before pairing, look for the SN number inside the aircraft battery compartment:



[For SN number ending with V01](#)

[For SN number ending since V02 \(V02, V03, V04 ... etc\)](#)

## For SN number ending with V01

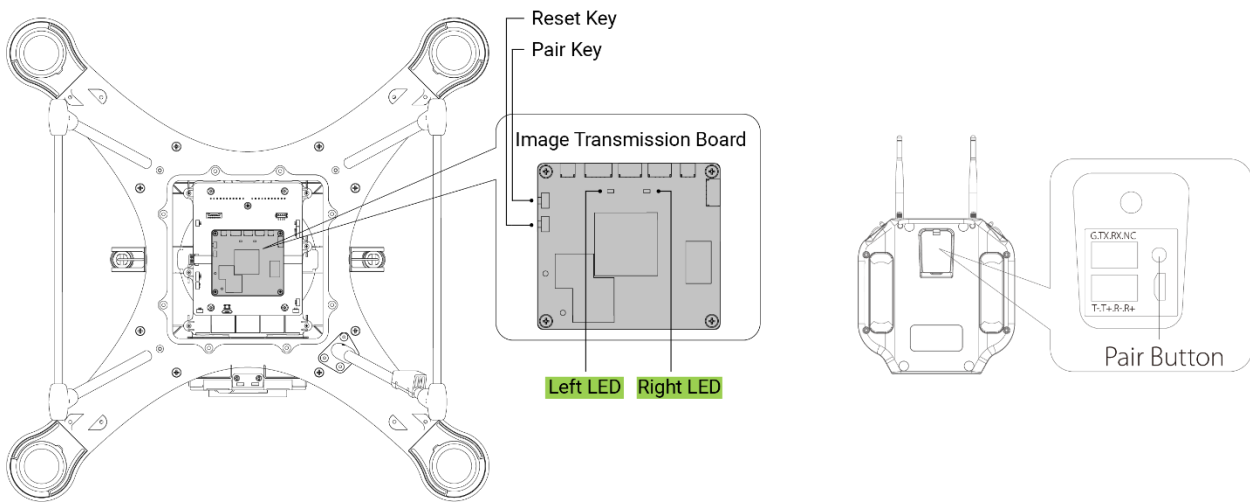

### To pair

1. Turn over the aircraft and place it on the carrying case. Unscrew and take off the bottom plate.
2. Turn on both the aircraft and remote control. Wait for 1 minute until the right LED light turns from flashing to solid.
3. Long press the pair button for 10 seconds. (Do not press shorter than 10 seconds) The right LED will start flashing. **\*If the right LED does not flash, please repeat the step until the right LED starts flashing.**
4. Wait for 1 minute until both the left and right LED turn solid. The reset process is complete.
5. Now, long press the aircraft's pair button for 5-10 seconds. (Do not press shorter than 5 seconds) The right LED will start flashing. **\*If the right LED does not flash, please repeat the step until the right LED starts flashing.**
6. Quick press the remote control's pair button **twice**. Wait for 5 seconds. The left and right LED will flash alternatively.
  - **\*If the left and right LED do not flash alternatively in 10 seconds, please repeat this step again until the left and right LED flash alternatively.**
  - **\*If the left LED does not flash and the right LED has already turned solid. Please repeat the pairing process again from step 1.**
7. The pairing process can take up to 3 minutes. When the pairing process is complete, the right LED will turn from flashing to solid, and the left LED will stay flashing. The remote controller will prompt "Aircraft initializing, please wait".
8. Assemble the bottom plate back, turn over the aircraft and place it on a level surface. The "Aircraft initializing, please wait" prompt will disappear in 30 seconds, and you are now ready to fly.

**If the pairing process does not succeed, please try to pair them again from step 1.**



---

## For SN number ending since V02 (V02, V03, V04 ... etc)

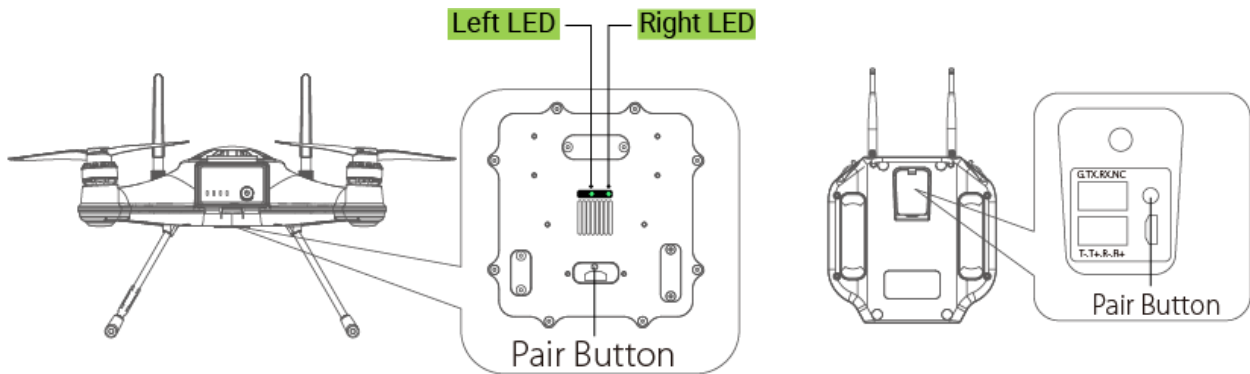

### To pair

1. Turn over the aircraft and place it on the carrying case. Unscrew and take off the "USB/Pairing Button" plate.
2. Turn on both the aircraft and remote control. Wait for 1 minute until the right LED light turns from flashing to solid. **\*If the aircraft and remote control are turned on beforehand, please restart both the aircraft and the remote controller.**
3. Long press the pair button for 10 seconds. (Do not press shorter than 10 seconds) The right LED will start flashing. **\*If the right LED does not flash, please repeat the step until the right LED starts flashing.**
4. Wait for 1 minute until both the left and right LED turn solid. The reset process is complete.
5. Now, long press the aircraft's pair button for 3-5 seconds. (Do not exceed 5 seconds) The right LED will start flashing. **\*If the right LED does not flash, please repeat the step until the right LED starts flashing.**
6. Quick press the remote control's pair button **twice**. The left and right LED will flash alternatively.
  - **\*If the left and right LED do not flash alternatively in 10 seconds, please repeat this step again until the left and right LED flash alternatively.**
  - **\*If the left LED does not flash and the right LED has already turned solid. Please repeat the pairing process again from step 1.**
7. The pairing can take up to 3 minutes. When the pairing process is complete, the right LED will turn from flashing to solid, and the left LED will stay flashing. The remote controller will prompt "Aircraft initializing, please wait".
8. Assemble the bottom plate back, turn over the aircraft and place it on a level surface. The "Aircraft initializing, please wait" prompt will disappear in 30 seconds, and you are now ready to fly.

If the pairing process does not succeed, please try to pair it again from step 1.

## Remote Controller Rear Ports

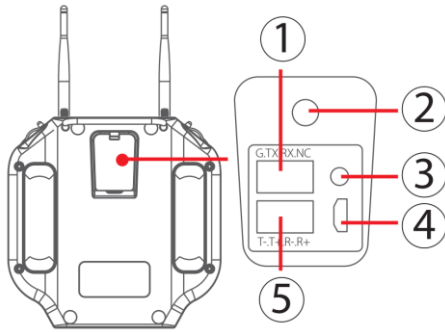

- ① **SDK Serial Port:** access to flight control data and transparent transmission.
- ② **Charging Port:** remote controller charging port.
- ③ **Pairing Button:** used for aircraft and remote controller pairing.
- ④ **Micro USB:** use for remote controller firmware upgrade.
- ⑤ **Ethernet Port:** This supports the development of computer ground station software to control the aircraft and its airborne equipment.

⚠ Ensure to tightly seal the rear rubber sealing before use to prevent water getting in to the remote controller.

# Flight

The drone relies on sensitive sensors to control flight positioning and stability. The SplashDrone 4 is flight tested before shipment, however, an initial calibration of the compass is required for your first use.

⚠ Before operating the drone from a ship or other moving platform, ensure all necessary calibrations have been completed before aboard, as some calibrations require a completely stable platform.

## Flight Safety and Environment

- Please make sure you have a comprehensive understanding of the SplashDrone 4, and all the necessary measures required to implement a successful return home function in the event of an emergency.
- If this is your first time flying a drone, please read this manual thoroughly and watch the tutorial videos on our website [support.swellpro.com](https://support.swellpro.com), or our YouTube channels.
- We recommend taking professional training and guidance. When flying, choose an appropriate environment according to your skills. Check all calibrations and choose a large open area to practice.
- It is **strongly** recommended that all drone pilots become familiar with flying in ATTI mode in case of GPS or magnetic interference, which may result in malfunction when flying on GPS mode.
- When experiencing GPS and magnetic interference during the flight, switch to ATTI mode to gain full control and safely return the aircraft manually. Failure to do so and result in aircraft crashing, the pilot takes the full responsibility.
- Please be well prepared before each flight, avoid any violent or excessive operations.
- Please maintain strict compliance with the local laws, any flying in NO-FLY ZONES is prohibited.
- Any illegal & improper use or operation of this product is prohibited.
- Any invasion & violation of another person's right to privacy is not allowed. Before using this product, it remains the duty of the drone pilot to comply with the local laws regarding privacy protection.
- Any invasion or flying over another person/s property is not allowed, please agree with any persons regarding any potential breach of privacy before the proposed flight.
- DO NOT fly the SplashDrone 4 under the influence of alcohol, drugs, or any other physical or mental impediment.
- Do not fly the drone with a malfunctioning remote controller.
- Please fly the drone away from crowds.

## Flight environment requirement

- Always choose the open space as an ideal flying environment.
- Flying between or near tall buildings could adversely affect the functioning of the compass and adversely affect or block GPS and transmission signals.
- During the flight, try to maintain the line of sight with the drone, keep away from obstacles and people.
- Avoid flying near areas with high electromagnetic interference such as power lines or signal towers to minimize the risk of interfering with the remote controller of the drone.
- Fly below 4000 meters above sea level as environmental factors including air density and wind shear reduce the performance of the aircraft and battery.
- Before flying in low temperatures, warm the battery to  $\sim 25^{\circ}\text{C}$  to maximize flight time.
- Although the SplashDrone 4 is waterproof, do not fly in fog or strong wind conditions. (For wind speed exceeding 14 m/s, or above Beaufort Force 6)

### Restricted Area



Airport



Crowds

### Threats to Flight Safety Scenarios



Radio signal tower



Radar

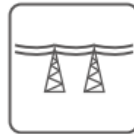

High voltage power lines



Trees



Tall buildings

## Flight Restrictions

According to provisions of the International Civil Aviation Organization and many national air traffic regulations, drones must be operated in specified airspaces. By default, the SplashDrone 4 is configured to not exceed an altitude of 120m the Home Point altitude.

**💡 If you need to cancel the height limitation, please set the flight altitude to 0 on the SDFly App.**

## Pre-Flight Checklist

- Intelligent batteries, remote controller, and your mobile devices are fully charged.
- Check all propellers are in good condition and correctly installed.

**Ensure there is no wobble on the propeller after you install. If you correctly install the propeller, the propeller still wobbles, you might need to tighten the screws on the propeller base.**

- Manually rotate the 4 motors to ensure they can spin smoothly.
- Make sure the waterproof barometric membrane is not damaged.
- **Make sure all the connector sealings are tightly sealed with the rubber rings attached, include the battery sealing, all the base connector ports. Make sure the sealings are free of dirt, sand, and other debris.**
- All the payload modules are tightly mounted to the aircraft.
- Micro SD card has been inserted and tightly sealed.
- SDFly App is successfully connected to the aircraft.
- Check the following flight data: flight battery > 16.0V; remote controller battery > 1 bar; Satellite > 5.

## Compass Calibration

Compass calibration is necessary for any of the following situations:

- The drone is brand new.
- The drone has been repaired.
- The drone has been subjected to strong magnetic fields.
- The drone has been crashed or subjected to heavy shaking.
- The drone sways or drifts excessively during hovering in GPS mode.
- The drone is more than 100 km away from the last calibration location.
- The drone is not able to fly straight.
- The drone is flying to a certain direction when there is no input from the remote controller.
- The remote controller screen prompts "WARNING Compass error Calibrate Compass".

**Compass Calibration Process:**

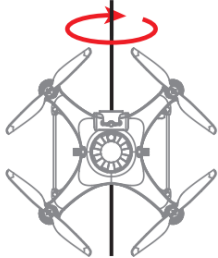
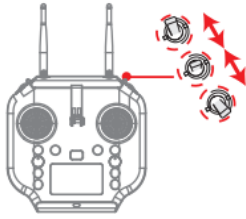

1. Place the drone on a level surface, power on the remote controller then the drone. Wait for the aircraft to connect to the remote controller.
2. After the connection finishes, fast switch the Flight Mode toggle back and forth until the aircraft's rear status indicators flash green, or the remote controller screen prompts "**Compass Calibration Rotate The Aircraft Horizontally**". The drone will now perform compass calibration.
3. Pick up the aircraft and hold the drone horizontally and rotate clockwise about 2~3 turns until the rear indicators slowly flash green or the remote controller screen prompts "**Compass Calibration Rotate Aircraft NOSE DOWN**".
4. Hold the drone nose-down and rotate clockwise about 2~3 turns until the remote controller screen prompts "**Aircraft Initializing, Please Wait**".
5. Place the drone on a level surface for 30 seconds. When the prompt disappears, power off and restart the drone.
6. The compass calibration is complete.

⚠ 1) Compass calibration needs to be performed outdoors in an open area. 2) Remove propellers before calibration. 3) Perform the calibration process away from sources of magnetic fields, such as large metal structures, radio signal towers, power lines or mobile phones, etc.

## Gyroscope Calibration

The gyroscope provides stability data to the flight controller. If the gyroscope is not well calibrated, the aircraft will tilt to one side when it takes off, and the tilted angle will increase until the aircraft can no longer fly.

Process gyroscope calibration for the following situations:

- The drone trembles significantly during hovering in GPS mode.
- The drone's tilt range is too large during ascending in ATTI mode.
- The drone drifts during ascending or descending in GPS mode.
- The drone has been crashed or subjected to heavy shaking.

- The remote controller screen prompts "WARNING Gyroscope error Calibrate Gyroscope".

### Gyroscope Calibration Process:

1. Place the drone on a level surface, power on the remote controller, then the drone. Wait for the aircraft to connect to the remote controller.



2. Hold the left joystick down to its lowest position, then quickly move the right joystick left to right, back and forth, until the front and rear status indicators flash alternately, or the remote controller screen prompts "**Aircraft Initializing, Please Wait**". The drone will now perform gyroscope calibration. Now release the joysticks. This process will be completed in 20 seconds. Do not move the drone during this process.

3. When the front status indicators turn solid red and the rear status indicators turn solid green, or "**Aircraft Initializing, Please Wait**" prompt disappears, power off and restart the drone. Gyroscope calibration is complete.

⚠1) Never calibrate the gyroscope on a boat or other moving platforms. 2) When the drone is floating on water, it may occasionally prompt gyroscope calibration, which is normal and can be ignored. 3) If the calibration fails, the "**Aircraft Initializing, Please Wait**" prompt will not disappear, please follow the steps, and try to calibrate again.

## IMU Calibration

The Inertial Management Unit (IMU) provides the raw data of the aircraft's attitude in space in nine dimensions. The IMU accelerometer sensor is critical to balance the aircraft in flight.

### Proceed IMU calibration for the following situations:

- The drone cannot arm (unlock) the motors after the compass calibration.
- The drone sways or drifts excessively during hovering in GPS mode.
- The drone has been crashed or subjected to heavy shaking.
- The remote controller screen prompts "WARNING IMU error - Calibrate IMU".

### IMU Calibration Process

1. Place the drone on a level surface, power on the remote controller, then the drone. Wait for the aircraft to connect to the remote controller.

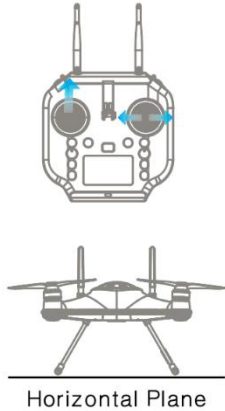

2. Hold the left joystick up to its highest position, then quickly move the right joystick left to right, back and forth, until the front and rear status indicators flash alternately, or the remote controller screen prompts "**Aircraft Initializing, Please Wait**". The drone will now perform IMU calibration. Now release the joysticks. This process will be completed in 20 seconds. Do not move the drone during this process.

3. When the front status indicators turn solid red and the rear status indicators turn solid green, or "**Aircraft Initializing, Please Wait**" prompt disappears, power off and restart the drone. IMU calibration is complete.

⚠1) Never calibrate the IMU on a boat or other moving platforms. 2) When the drone is floating on water, it may occasionally prompt IMU calibration, which is normal and can be ignored. 3) If the calibration fails, the "**Aircraft Initializing, Please Wait**" prompt will not disappear, please follow the steps, and try to calibrate again.

## Basic Flight Steps

1. Check that the aircraft is correctly assembled.
2. The propellers are correctly mounted and secure.
3. The battery hatch is closed and locked.
4. The silicone plug on the back of the remote controller is closed.
5. The mobile device is securely mounted to the remote controller.
6. Place the aircraft on flat open ground or water.
7. Power on the remote controller, followed by the drone.
8. Connect the mobile phone to the remote controller Wi-Fi.
9. Open the App and wait for the camera image to Appear and the flight data display is normal.
10. Check the following flight data: flight battery > 16.0V; remote controller battery > 1 bar; Satellite > 5.
11. For your safety, you should stand upwind and at least 3 meters away from the drone.
12. Novice pilots should always take off in GPS mode.
13. Arm the drone or use the auto take-off on the App.
14. Push the left(throttle) joystick up slowly, allowing the drone to take off smoothly. Release the throttle when the drone is Approximately 1.5 m high. Allow the drone to hover for a moment to ensure flight stability.
15. When you need to descend, gently pull down the left(throttle) joystick, allowing the drone to descend and land on a flat surface or the water.



16. After landing, keep the left(throttle) joystick down to its lowest position for 3 seconds until the motors stop, or you can use the disarm joystick command to stop the motors.
17. Stop video recording before shutting down the drone, otherwise, the video file may be damaged.

## Starting/Stopping Motors (Arming the Drone)



### Before starting the drone, take the following precautions:

1. Place the aircraft in an open area 3 meters away from yourself and others. After the aircraft is powered on, the system will conduct self-checking. After the self-checking is completed, it will sound a confirmation tone.
2. Novice user should fly in GPS mode.
3. If the aircraft cannot be unlocked due to weak GPS signal, switch to ATTI mode to unlock the aircraft. However, it is not recommended for novice pilots to fly in this mode, as the location of the drone is not fixed when flying in this mode.
4. In Custom mode, the motors cannot be unlocked in Cruise, Orbit, Headless mode.

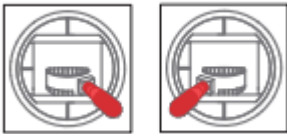
### Starting (Arming) Motors

Remote controller operation	Description
	<p>Pull both the left and right joysticks simultaneously down and inwards and maintain this position for 3 seconds. The motors will be unlocked and start rotating.</p>

### Stopping Motors (Emergency Stop)

Remote controller operation	Description
	<p>Method 1: After the aircraft has landed on the ground or water surface, pull the throttle to the lowest position, and hold for 3 seconds. The motor will be lock and stop rotating.</p> <p> The recommended method for stopping motors.</p>

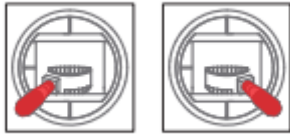

Method 2: Pull both the left and the right joysticks downwards and outwards. This method can be used as an emergency stop.

⚠ Stopping the motors in flight may cause the drone to crash and should only be carried out in an emergency when stopping the motors will minimize potential damage. (For example, there is a risk that the drone may hit people or crowds)

## Water Takeoff and Landing

1. When taking off from choppy water, ascend quickly from the surface to prevent the drone from being affected by a passing wave.
2. When landing on water, descend vertically to the surface. If the drone lands with horizontal speed, it may flip and be inverted. The flight controller will shut down the motors if the drone becomes inverted on the water.

⚠ Do not leave the drone floating inverted for more than a few minutes. Flip the drone using the Power-Flip command or recover the drone as soon as possible to avoid water saturating the waterproof barometric membrane.

## Boat Takeoff and Landing

When takeoff or landing from the boat/kayak, **PAY EXTRA ATTENTION** to the operation, as it can be very difficult and dangerous to operate the aircraft.

- There should be enough space for the drone to take off or land on the boat.
- If there is not enough space on the boat, take off and land on the water can otherwise be a safer, alternative option, as there is sufficient space for the drone to operate.
- When the boat is rocking, the drone may not arm its motors in GPS mode. In this case, carefully take-off in ATTI mode and then switch to GPS mode if the satellite signal is back to.
- Always be aware of the direction of the wind relative to the boat for take-off and landing. Stand in the upwind position relative to the aircraft to prevent the aircraft from drifting toward you when take-off or landing in windy conditions.
- The Smooth+ controls are useful to finely control and balance the drone position during this operation.
- For your safety, it is not recommended to launch or land the SplashDrone 4 from your hands.

- After initiate return-to-home on the boat, always regain control and land manually when the aircraft is approaching near you.

## Power Flip

If the drone becomes inverted on the water, the Power-Flip feature enables the drone to flip back to its upright position.

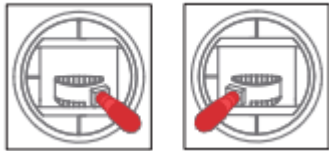

When the drone floating upside-down on the water, pull both the left and right joysticks simultaneously down and inwards and maintain the control until the drone flip over to its upright position.

⚠ Power Flip feature is not applicable when the aircraft is equipped with the Boat Mode Kit (BKT).

## Flight Modes

There are 7 flight modes to configure on the SplashDrone 4 to accommodate the different flight preferences and needs. They are GPS mode, ATTI mode, Sport mode, Orbit mode, Cruise mode, Headless mode, Manual mode, and Boat mode.

### For GPS mode and ATTI mode:

GPS mode and ATTI mode can be set by simply switch the flight mode toggle on the remote controller.

### For Sport mode, Orbit mode, Cruise mode, Headless mode, Manual mode:

Switch the flight mode toggle to Custom mode, then turn to the SDFly App and set the flight mode among these 5 modes on the App flight mode section.

For Return to Home, Follow Me modes, refer to [Dynamic Return to Home](#) and [Intelligent Follow](#) sections for detail info.

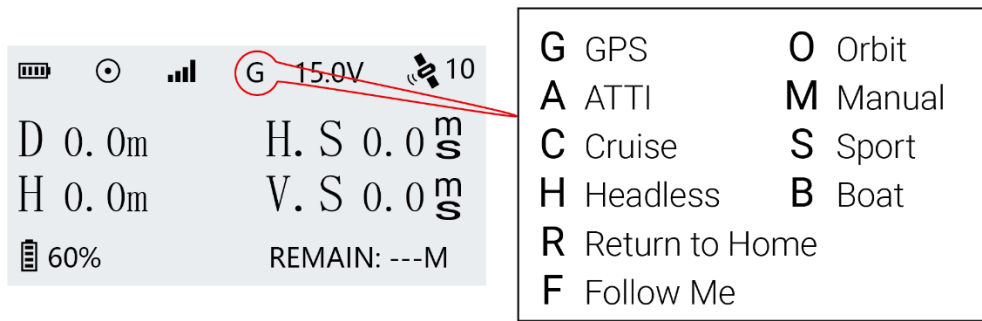

Flight Modes	Letter	Description
<b>GPS</b>	<b>G</b>	In GPS mode, the drone maintains a fixed position and height while hovering (with no input from the remote controller). The maximum flight speed is 10 m/s.
<b>ATTI</b>	<b>A</b>	In ATTI mode, the drone maintains a fixed height but not a fixed position. Therefore, when there is no input to the remote controller, the drone is going to drift with the wind while maintaining its height. The maximum flight speed is 22 m/s.
<b>Sport</b>	<b>S</b>	In Sport mode, the drone is going to fly extremely fast and responsively. When there is no input to the remote controller, the drone is back to GPS mode which maintains its height and position. It is great for extreme operation required for fast and responsive flight. It also provides a fun and exciting flight experience.  <div style="background-color: yellow; padding: 5px;"> <p>⚠ As the drone becomes extremely fast and responsive in Sport mode, it is recommended to use for a more experienced and skilled user.</p> </div>
<b>Orbit</b>	<b>O</b>	In Orbit mode, the drone is going to proceed to a circle flight with a default 10m radius. The orbit radius can be set on the remote controller or through the App. To set the orbit radius on the remote controller, pull down the right joystick to increase the radius, pull up the right joystick to decrease the radius. The minimum radius is 10 m. The max radius can be set to 150 m.
<b>Cruise</b>	<b>C</b>	In Cruise mode, the drone is going to maintain the direction and speed of your input after you release the remote controller.

<b>Headless</b>	<b>H</b>	In Headless mode, the head orientation of the drone is dismissed. The drone can now move in the direction with respect to your point of view. This makes controlling the drone from afar more intuitive and makes manual return-to-home a lot easier when you cannot see the head direction of the drone.
<b>Manual</b>	<b>M</b>	<p>In Manual mode, the drone is NOT going to maintain its height and position. The height, position, and speed of the drone need to be controlled manually in this mode, but the drone is going to maintain level during the flight.</p> <p><b>⚠ This mode should ONLY be used for experienced and skilled users. Please use with caution.</b></p>
<b>Boat</b>	<b>B</b>	<p>In Boat mode, the SplashDrone 4 can effectively be controlled like a boat on the surface of the water. To move the drone forward, pull the right joystick up. To move the drone's direction left or right, pull the left joystick left or right to control. The drone is not able to move backward in boat mode. The drone's speed is limited to 1 m/s. In Boat mode, the App's mission planning can be used normally: tap to fly, waypoints, mapping, orbit.</p> <p>To enter the Boat mode:</p> <ol style="list-style-type: none"> <li>1. Land or place the drone on the water.</li> <li>2. For landing on the water, lock the drone.</li> <li>3. Switch the drone to GPS or ATTI mode.</li> <li>4. Arm the drone by using the inward gesture.</li> <li>5. Press the BOAT button on the remote controller.</li> <li>6. The drone now enters the Boat mode.</li> <li>7. Press the BOAT button again to exit Boat mode. The drone can then take off normally.</li> </ol> <p>Boat mode Application:</p> <p>For underwater photography and underwater search, use SwellPro gimbal cameras and an extension bar. For fish searching, use SwellPro fish finder Dronar 01.</p> <p>For overwater photography, use SwellPro gimbal cameras and the Gimbal Overhead Kits.</p> <p><b>⚠ Boat mode can ONLY be used when the drone equips with SwellPro Boat Mode Kit (BKT). DO NOT use the Boat mode without the floating foams. Using Boat mode on the water without floating foams can result in serious damages to the propellers and motors.</b></p>

⚠ When using Boat mode on the water, be careful of the landing gear and other attached accessories getting caught on weed or other debris to prevent the drone from flying. Be aware of the weeds and other debris to prevent the landing gear and other attached accessories from getting caught by them, which can cause the drone not to be able to move or take off.

💡 There is a Slow mode embedded in all flight modes for a safer flight purpose. (For example, when the drone is equipped with SwellPro Gimbal Extension Bar (GEB), switching to Slow mode allows the drone to fly more stable and safely.) Press the PAYLOAD(Right) / Slow Mode button 3 times to enter Slow mode.

## Intelligent Follow

Thanks to the built-in GPS module on the remote controller. The drone can accurately track the location of the remote controller. When Follow Me mode is turned on, the drone will accurately track and follow the remote controller's position, you can still adjust the aircraft direction, following distance, camera angle on the remote controller.

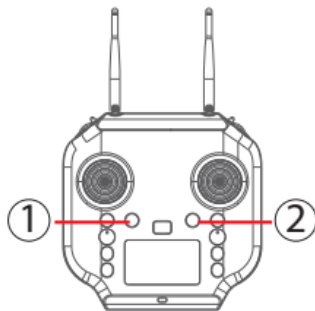

**Start Follow Me:** 1) Check that the remote controller has a GPS signal by checking the GPS status indicator on the screen. (The GPS status icon is not flashing) 2) Press and hold the Follow Me button ① to start Follow Me mode. The remote controller will beep twice.

**Stop Follow Me:** Press and hold the "FOLLOW ME" button again until the remote controller beep once to indicate that Follow Me mode is disengaged.

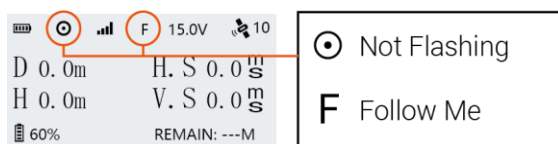

💡 When the remote controller or the drone lost the GPS signal, Follow Me mode will automatically be disengaged, and the drone will hover on a fixed position in the air.

💡 When the remote controller and the drone lost connection, the remote controller will beep and vibrate once, and the drone will initiate the return-to-home process.

⚠ Be aware of the drone's surrounding to prevent the drone from crashing into other objects when using Follow Me mode.

⚠ Since the drone track the GPS location of the remote controller, keep the remote controller in an open-air environment to prevent the built-in GPS from signal lost. (It is not recommended to put the remote controller inside the car or kayak.)

## Smooth+

The patented "Smooth+" flight control allows the pilot to finely tune the Roll and Yaw of SplashDrone 4. Smooth+ makes professional, steady flight control as easy as turning the knobs.

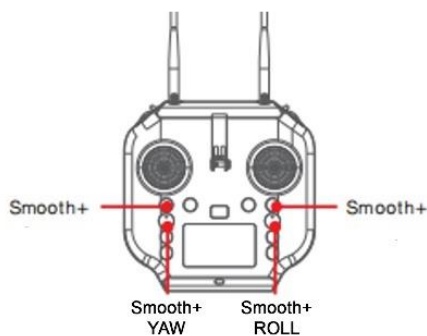

To enter Smooth+ mode, simply press the Smooth+ buttons.

Press the left Smooth+ button to engage Smooth+ YAW. The left joystick will now only control the ascend/descend of the drone.

Press the right Smooth+ button to engage Smooth+ ROLL. The right joystick will now only control the pitch of the drone.

## Dynamic Return to Home (RTH)

The SplashDrone 4 constantly receives the GPS location of the remote controller, allowing the aircraft to always return to the pilot even if they have moved from the original take-off point.

The aircraft will always return to the remote controller location, not the take-off location.

- If no GPS location is established by the remote controller, the drone would return to the take-off point.
- If the remote controller lost the GPS signal during the RTH process, the drone would return to the last known GPS location of the remote controller.

After the return function is activated either manually or automatically, the aircraft will fly to the remote controller's location. Keep in mind that when the aircraft fly back within the range of 30 meters from the remote controller, the aircraft will stop sensing the remote controller's GPS location and return to the last recorded GPS location from the remote controller. The aircraft is going to land on the remote controller's location.

To start Return-to-Home:

- Long press the Return Home button, the remote controller will beep and vibrate twice to indicate that the drone starts the RTH process. The flight mode indicator on the remote controller status bar will change to the letter "R" to indicate the drone is in the RTH process.
- Return-to-Home can also be initiated on the App.
- The RTH height can be set on the App.

### Return Home Process

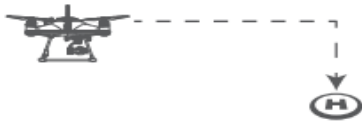

If the aircraft's height is higher than Return-to-Home Height, the drone will maintain its height and return to its home point before landing.



If the aircraft's height is lower than Return-to-Home Height and distance from Home Point > 15m, the drone will ascend to Return-to-Home Height and then return to its Home Point before landing.

During the return home process, the left and right joysticks of the remote controller can be controlled to avoid obstacles or change the landing location. When you stop controlling the joysticks, the aircraft will continue the RTH process. During the RTH process, the Flight Mode toggle is disabled, but the control of attached accessories such as the gimbal camera or payload release module still functions normally.

💡 Return-to-Home Height can be set on the App.

⚠️ If the aircraft's GPS signal is too weak (GPS signal shows 0), the aircraft is not able to initiate RTH.

⚠️ Keep your eyes on the aircraft during the RTH process, watch out for any obstacles on the flight path.

⚠️ If aircraft set to return to remote controller, ensure remote controller has good GPS signal during the entire RTH process. (The remote controller GPS status icon is not flashing)

### Low Battery Auto Return to Home

Low battery auto Return-to-Home can be turned on or off through the App on your preference. By default, low battery auto Return-to-Home is on.

Low battery auto RTH will initiate when the drone intelligent battery reaches Level 1 low battery warning.



**\*\*\*.WARNING.\*\*\***

**LOW BATTERY**

**Return Aircraft  
and Land**

*Level 1 alarm:* The drone battery level has reached 13.0 V. The remote controller screen will prompt "LOW BATTERY; Return Aircraft and Land". The front drone status indicators will flash a pattern of 4 red lights. If low battery auto Return-to-Home is turned on, the drone is going to auto RTH after this low battery warning.

## **Low Battery Auto Payload Release**

Low battery auto payload release is used to increase the RTH possibility when the drone is attached to a heavy load. Low battery auto payload release can be turned on or off through the App on your preference. By default, the low battery auto payload release is off.

When it is on, the low battery auto payload release will be initiate when the drone reach level 1 low battery warning. On level 1 low battery warning, the drone will automatically release the payload then initiate low battery auto Return-to-Home process.

## SDFly App

SDFly is the whole new flight App designed by SwellPro. It marks the new era for SwellPro. SDFly allows SwellPro pilots to do live HD viewing; adjust aircraft and camera setting; proceed with mission planning (include waypoints and mapping); easily browse, download, and share aerial footage. This App currently only supports the SplashDrone 4. It works both on iOS and Android.

## Download SDFly

SDFly can be downloaded on App Store or Google Play. To download the intall package, go to [support.swellpro.com](https://support.swellpro.com) and search for "SDFly App".

## Connect SDFly

After successfully installing the App, turn on the remote controller and then the drone. Connect your mobile device to the remote controller's Wi-Fi hotspot named **SWP\_Bxxxxx**. The default password is "12345678".

After connecting the Wi-Fi, open the SDFly App. You can now log in to the drone.

💡 SplashDrone 4 remote controller allows for up to 4 mobile devices to connect simultaneously. Multiple people can operate the drone together. All the connected devices can control the aircraft, but only the first connected device is able to show the image transmission.

⚠️ The Wi-Fi connection only supports 5G Wi-Fi (Wi-Fi 5 or Wi-Fi 6). Please use the mobile device that supports 5G Wi-Fi in order to connect to the remote controller's hotspot.

## Use Mobile Data

Connecting the mobile device to the remote controller's Wi-Fi can cause the internet connection to be interrupted.

### For iPhone/iPad Users

Proceed to the following steps to use the mobile data while connecting to the remote controller's Wi-Fi:

1. Go to the device's Wi-Fi setting. Look for the remote controller's Wi-Fi (**SWP\_XXXXXX**). Tap in the setting for the Wi-Fi.
2. Under IPV4 address, set "Configure IP" from automatic to manual mode.
3. Configure the manual IP: IP address to "192.168.2.110"; Subnet Mask to "255.255.255.0".
4. Your iOS device is now able to use mobile data while connecting the remote controller's Wi-Fi.

## For Android Users

Turn on the **Auto Switch to Mobile Data** to allow the phone to use mobile data while connecting to the remote controller. Go to Wi-Fi setting > Wi-Fi Preference > Auto Switch to Mobile Data (names might vary depending on different types of phones, not every phone has this function).

## Home Screen

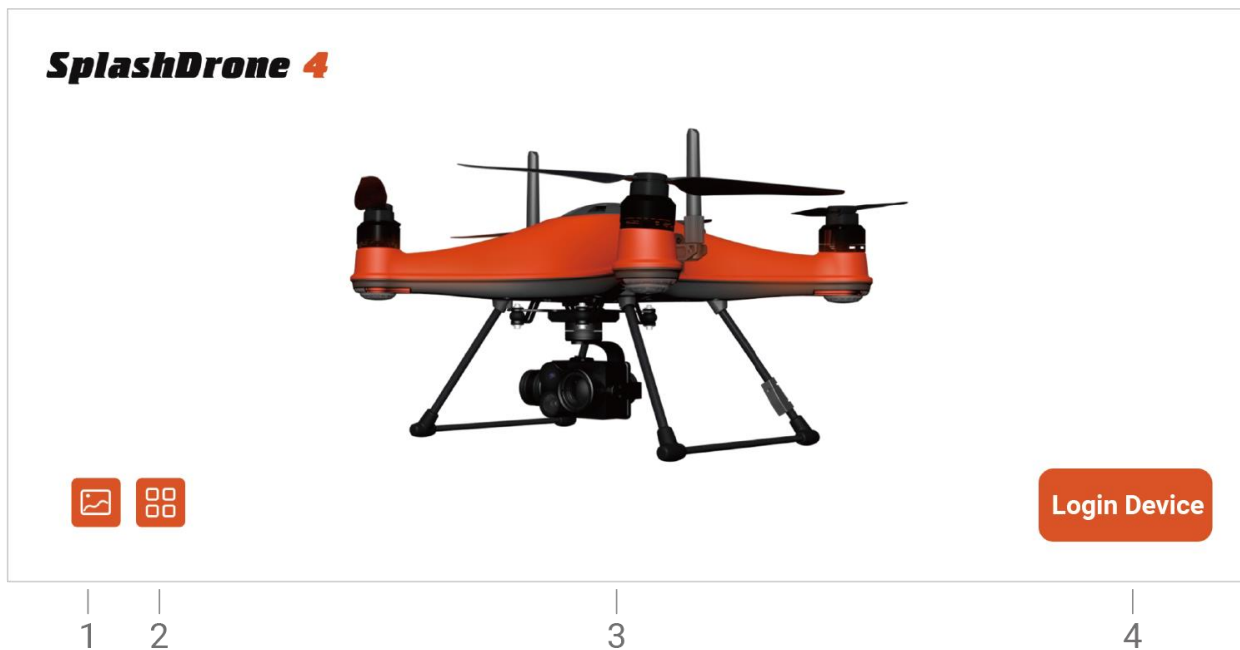

1. **Gallery:** Browse the photos/videos taken from the camera.
2. **Info:** Look for the info about SwellPro website, store, and contact information.
3. **Connection Status:**  
Orange - connected to aircraft.  
Gray - disconnected to aircraft.
4. **Login:** Tap to enter the main interface.

## Main Interface

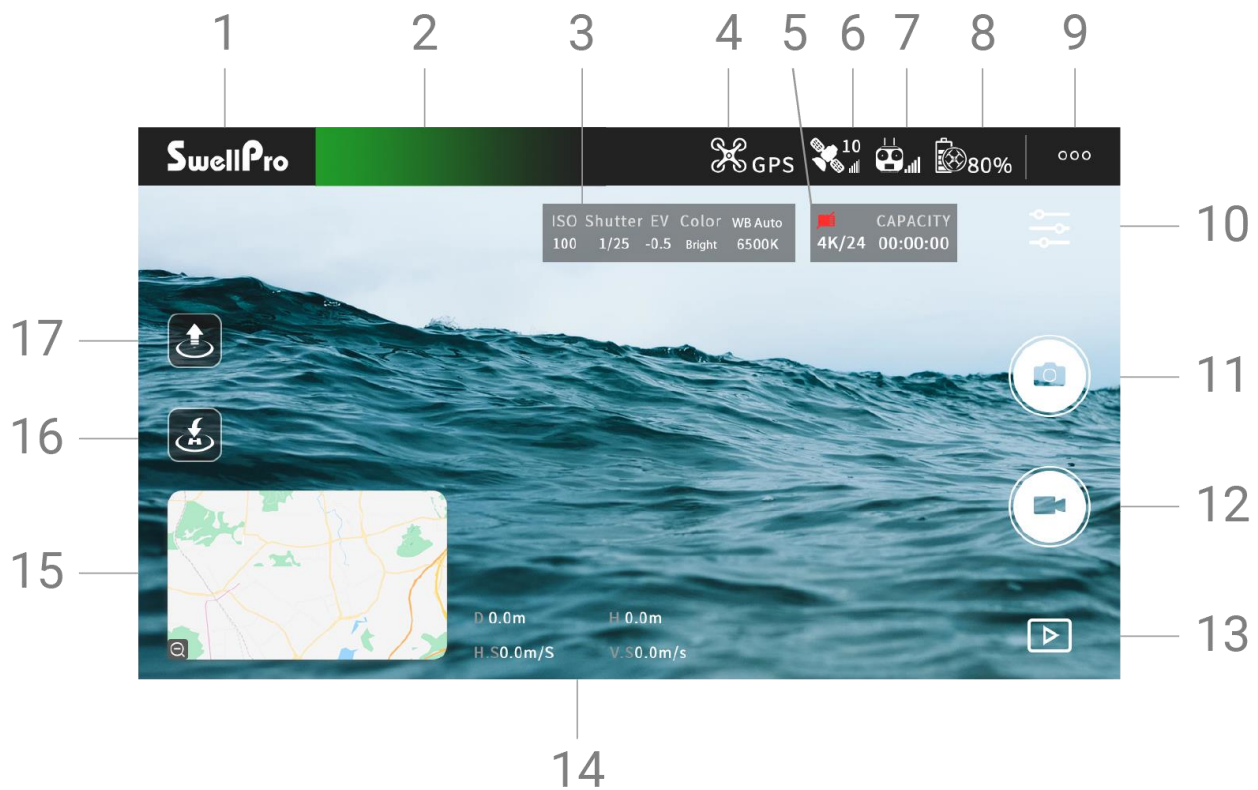

1. **Home Screen:** Return to the main interface.
2. **Aircraft Status:** Displays the status of the aircraft.
3. **Camera Parameters:** Current camera parameters.
4. **Flight Mode:** Current flight mode.
5. **Memory card Information:** Remain memory card capacity.
6. **GPS Signal Level:** GPS signal quality.
7. **Remote Controller Signal Level:** The signal quality between the remote controller and the aircraft.
8. **Aircraft Battery Level:** Real-time display of the battery voltage.
9. **Flight Settings:** Set the drone flight settings and configure flight parameters.
10. **Camera Settings:** Set camera parameters and settings.
11. **Photo:** Take a photo.
12. **Video:** Start/stop video recording.
13. **Playback:** Browse photos and videos that have been taken.
14. **Flight Parameters:** D: Distance between the aircraft and the home point | H: Aircraft height from Home Point | HS: Aircraft horizontal speed | VS: Aircraft vertical speed

15. **Thumbnail map:** Tap to quickly switch to the map interface.
16. **Tap to return:** Tap to start auto return to home (RTH).
17. **Tap to take off:** Tap to auto take off and hover at a height of 3 meters.

## Map Interface

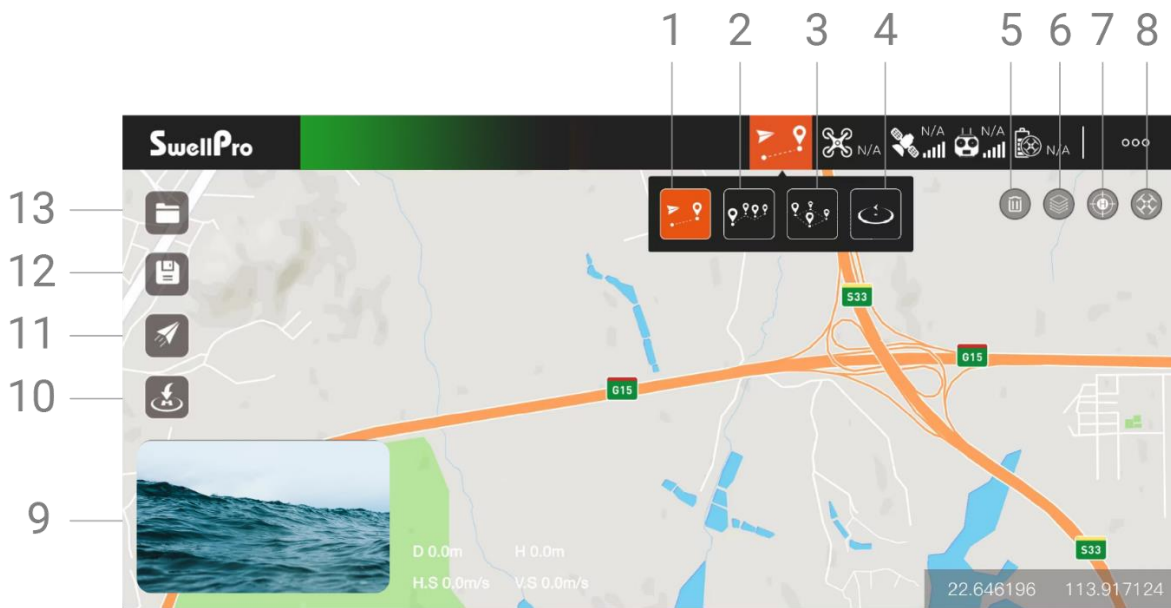

### 1. Tap to Fly

In GPS mode, tap where you want to fly to on the map and the SplashDrone 4 will automatically fly to the location and hover. You can also manually enter longitude and latitude as well as set altitude and speed.

### 2. Waypoints

Select several waypoints on the map, the SplashDrone 4 will fly in a route through the series of waypoints. The height, speed, hover time can also be set for each waypoint.

### 3. Mapping

Set an area boundary on the map, Mapping function will create a series of waypoints forming grid-pattern routes on the map. The drone will then follow the route and proceed with grid flight over the selected area. The spacing between routes, speed, height can be set on the App. The number of waypoints that can be created for Mapping is between 3 and 256. Mapping is useful for search and rescue, survey, and inspection missions.

### 4. Orbit

Orbit combines orbit mode with Tap to Fly. Pilots can set a point on the map and its radius. The drone will fly to the point and start orbiting. The orbit radius, speed, laps can be set on the App.

5. **Delete:** Tap to delete the set point on the map.
6. **Map Layer:** Pilots can choose from 3 different map layers: Standard, Satellite, Dark.
7. **Remote Controller Location:** Tap to quickly identify the location of the remote controller on the map.
8. **Drone Location:** Tap to quickly locate the position of the drone on the map.
9. **Thumbnail Screen:** Tap to switch between camera and map views.
10. **Tap to return:** Tap to start auto return to home (RTH).
11. **Execute:** Tap to excute mission planning (Tap to Flight, Waypoints, Mapping).
12. **Save:** Save the points set on the map for latter use (recurring tasks).
13. **Route Saved:** Access and perform the saved points.

## Set the Wi-Fi Password

### Set the Wi-Fi Password

To set the Wi-Fi password:

1. Connect the SDFly to the remote controller.
2. Login to the device.
3. Go to flight settings, showing as 3 dots on the top right of the interface.
4. Scroll to advanced settings and select "Set Wi-Fi Password".
5. Type the password you want and press "SAVE PASSWORD".
6. Re-connect the Wi-Fi.

### Reset the Wi-Fi Password

To reset the Wi-Fi password:

1. Power on the remote controller.
2. Wait for 40 seconds for the MultiSync video transmission system to boot up.

3. Press the pairing button on the back of the remote controller 5 times.
4. Wait for another 20 seconds for the Wi-Fi password reset to finish. The Wi-Fi password is restored to the default, 12345678.

💡 After resetting the Wi-Fi password, re-pairing the remote controller and the aircraft is **REQUIRED**. To re-pair, the remote controller, and the aircraft, check the pairing part under the remote controller section.

# Appendix

## Specifications

Aircraft	
Waterproof Rating:	IP67
Weight (include battery and propellers) :	2.18 kg
Axis Diameter:	450 mm
Max Ascend Speed:	4 m/s
Max Descend Speed:	4 m/s
Max Flight Speed:	22 m/s (ATTI), 10 m/s (GPS)
Max Tilt Angle:	ATTI: 25°; ATTI (slow mode): 12.5°
Max Altitude from Takeoff Point:	120m (GPS) / ATTI - no limitation
Max Wind Speed Resistance:	72 km/h   20 m/s   39 knot
Max Flight Time:	30 mins (no wind & no load);
Hovering Precision:	±0.5 m (vertical); ±0.5 m (horizontal)
Max Flight Distance:	5.0 km
Max Payload Capacity:	2.0 kg (Include payload accessories)
Max Take-off Weight	4.18 kg
Flight Control:	Hawk
Digital Video Transmission:	MultiSync
Motor:	#3509 - 740Kv (special coated)
ESC:	40A (flux)
Propellers:	#1242 carbon fiber quick release propellers
Motors:	#3509 - 740Kv
Operating Frequency:	5180 - 5875 MHz
Transmitter Power (EIRP):	FCC/IC: ≤ 24 dBm CE/SRRC/MIC: ≤ 20 dBm
Working Temperature:	-10°C ~ 40°C
Satellite Positioning Systems:	GPS/GLONASS
Pass-through Serial Port:	Connect to a third-party device and transfer the data of the third-party device to the remote control



**UART:** Allows for TTL serial port to TCP, with the baud rate of 115200

**Wi-Fi Hotspot** IP: 192.168.1.101:2222

**Power Input:** 12V/2A | 5V/2A

## Remote Controller (MRC)

**Waterproof Rating:** IP66

**Operating Frequency:** 5180 - 5875 MHz

**Transmitter Power (EIRP)** FCC/IC: ≤ 24 dBm  
CE/SRRC/MIC: ≤ 20 dBm

**Real-time Video** 720P@30fps

**Transmission:**

**Latency:** 200 ms (It depends on the actual shooting environment and mobile devices)

**Battery:** 2S 3000mAh

**Working Time:** 7 hours

**Working Current/Voltage:** 0.3A/7.4V

**Ethernet Port:** IP: 192.168.2.220:2222

**Wi-Fi Hotspot** IP: 192.168.2.220: 2020; Default password: 12345678

**Mobile Device Mount:** Suitable for any size phones;  
Tablets require a larger mount (sold separately)

**Screen:** 2.68 inch, 128x64

**Working Temperature:** -10°C - 40°C

**Remote Charging time:** 3 hours

**Power Input:** 5V/2A

## Intelligent Battery (IB4)

**Nominal Capacity:** 6600mAh

**Voltage:** 14.8V

**Type:** Intelligent 4S LiPo

**Watt Hours:** 97.68 Wh

**Size:** 153.6\*82.4\*48.3mm

**Weight:** 735 g (±5 g)

**Working Temperature:** -10°C - 40°C

**Charging Time:** 1.5 hour

**Max Charging Power:** 84 W

## Charger

Input	100 – 240V, 50/60Hz
Output:	16.8V@Dynamic Current / 5V@1.5A
Rated Power:	84.5 W

## Mobile Device connection

Operation Frequency	5180 - 5875 MHz
Max Transmission Distance (Unobstructed, free of interference)	10 m

## App

Mobile App Name	SDFly
Live View Quality	720p@30fps
Latency	< 250 ms (depending on environmental conditions and mobile devices)

## Firmware Update

For the best flight experience, please update the aircraft and the remote controller to the latest firmware.

## Flying Guide

- Many regulations require the pilot to fly a drone within line of sight. Take particular care when flying a drone out of sight.
- Unless it is an emergency, NEVER Lock or STOP the motors in flight as this will cause the drone to fall to the ground and crash.
- When the low battery level warning is activated, plan to return the drone and land safely before the battery reaches a critical level.
- The Return Home function can be used to reorient the drone towards the Home Point. By activating the Return Home function, the drone will rise to the return altitude (20m) and then turn towards the Home Point before starting its return.
- If any obstacles are in the flight path of the drone during a Return Home process, control should be regained by turning off the Return Home function.
- If you crash your drone, lock the motors to prevent damage to the motors and propellers.
- Do not attempt to touch the motors, until the motors have stopped rotating completely.
- When landing on water, avoid abrupt landings to avoid damage to the drone.

- When flying over water, avoid the drone dropping or crash into the water from a high altitude as this could cause major damage to the drone.
- Do not expose the drone & battery to direct sunlight for long periods as this can raise the internal temperature of the drone to well above the operating temperature range.
- If the drone does not Appear to be responding to the remote controller, as usual, switch the drone to ATTI flight mode and fly the drone to a safe landing location.
- The possible causes for the instability or loss of control of the drone could be poor GPS signal, poor radio signal, or weak Earth magnetic field.
- If the drone Appears to be affected by magnetic interference, try the following remedies.
- Re-calibrate both the compass and accelerometer on the SplashDrone 4.
- After completing the calibration, arm the drone motors to fly in GPS mode to verify whether this phenomenon has been eliminated.
- If the abnormality remains the same, please re-locate to another place at least 5KM away and re-calibrate the SplashDrone 4. Following the re-calibration, please test the drone again.
- If the problem persists, please contact SwellPro or your local dealer for further troubleshooting and solutions.

## Joystick Calibration

Calibration of the joysticks is necessary if the third page of the remote controller screen indicates that the control inputs are not centered when the joysticks are in their neutral position.

To calibrate the joysticks, refer to the SwellProTools firmware update instructions.

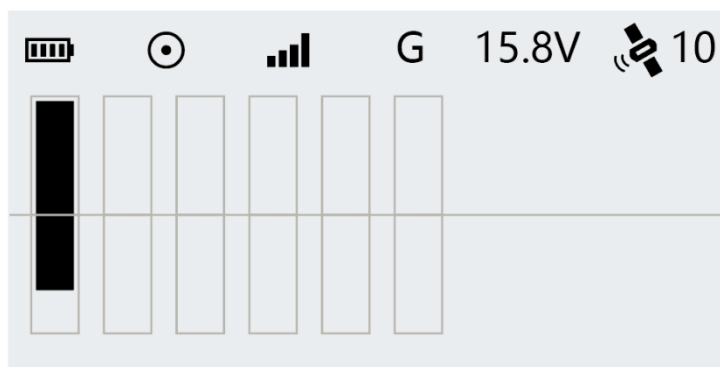

- ⚠ It is necessary to calibrate the remote stick when changing the throttle mode.
- ⚠ Before calibration, make sure that all toggle switches are set to the top position.

## Warranty Information

Please visit the SwellPro support website [support.swellpro.com](https://support.swellpro.com). Search "After-sales Policy" for warranty information.

## Battery Care and Maintenance

- Do not allow the batteries to come into contact with any kind of liquid.
- Do not drop the battery into the water.
- Do not leave batteries out in the rain, or near any sources of moisture. If the inside of the battery comes into contact with water, chemical decomposition may occur, potentially resulting in the battery catching on fire, and may even lead to an explosion.
- Never use or charge swollen, leaky, or damaged batteries. If your batteries are abnormal, please contact SwellPro or a SwellPro authorized dealer for further assistance.
- The battery can be used in temperatures ranging from -10°C to 40°C. Using the battery in environments above 60°C can lead to a fire or explosion. Using the battery below -10°C can lead to permanent damage.
- Never disassemble, or penetrate the batteries with sharp objects, otherwise, this may result in the battery catching fire, or even lead to an explosion.
- Electrolytes in the battery are highly corrosive. If any electrolytes make contact with your skin or eyes, immediately wash the affected area with fresh running water for at least 15 minutes, and then see a doctor immediately.
- If the battery falls into water, pick it up immediately and put it in a safe and open area. Maintain a safe distance from the battery until it is completely dry. Never use the battery again, and dispose of the battery properly as described in the Battery Disposal section below.
- Do not heat batteries. A battery fire can be extinguished using sand, or a dry powder fire extinguisher.
- Do not put batteries in a microwave oven, or a pressurized container.
- Do not put the loose battery cells onto any conductive surface, such as a metal table.
- Do not put any conductive cables or metal objects together with batteries, where they may short-circuit against each other.
- Do not drop or strike batteries.
- Do not place heavy objects on the batteries or the battery charger.
- Clean battery terminals with a clean, dry cloth. Failure to do so may result in poor electrical contact, which could reduce the battery capacity, or damage the charger.
- Do not continue to fly the drone after the low battery alarm has been activated; this will result in over-discharging the battery, and potentially could damage the battery cells.

## Precautions for low-temperature use

- When the battery use in a low-temperature environment (-10°C to 5°C), the battery capacity and flight time will be drastically reduced. It is recommended to take off when the battery is fully charged. Please fully charge and keep the battery warm before use.
- In a low-temperature environment, it is recommended to preheat the battery to above 5°C before flying, and it is better to preheat to above 20°C.
- Before flying in a cold environment, insert the battery into the aircraft to warm up for 1 to 2 minutes, and take off after the battery is fully warmed up.

## Battery Charging

- Always use a SwellPro Approved charger to charge the battery of the drone, and the radio controller. SwellPro takes no responsibility if the battery is charged using a non-SwellPro charger.
- To avoid any potential accidents happening, please do not leave the battery charging unattended.
- Do not charge the battery near flammable materials, or on flammable surfaces, such as carpet or wood.
- Disconnect the charger when not in use.
- Do not clean the charger with denatured alcohol or other flammable solvents.
- Never use a damaged charger.

## Battery Storage and Transportation

- If the drone is not being used for a long period of time, ensure to **fully charge** the intelligent flight battery and remote controller for storage. **To prevent the battery from over-discharge, recharge the battery every 3 months.**
- **Do not leave both the intelligent flight battery and remote controller battery unattended for an excessive period of time (longer than 3 months).** As the battery discharge over time, long storage time without recharge would result in battery over-discharge and cause permanent damage to the battery.
- It is recommended to fully charge the battery before put into storage, as the higher the battery level, the longer the battery can be stored.
- Keep batteries out of the reach of children and pets.
- Do not leave the battery near heat sources, such as a furnace, heater, or exposure to strong direct sunshine, for example: in cars
- The ideal storage temperature is 20°C ~ 28°C.
- Keep the battery in a dry and ventilated environment
- Never drop the battery into the water, or store it in places where there is a possibility of water leakage.
- Do not drop, strike, impale, pierce, or manually short-circuit the battery.
- Keep the battery away from metal objects, such as watches, jewelry, and hairpins.

## Battery Disposal

- Dispose of the battery in specific recycling boxes only after a complete discharge.
- DO NOT place the battery in regular trash containers. Strictly follow your local regulations regarding the disposal and recycling of batteries.

## Maintenance

- After flying over the sea, sand, or water, the SplashDrone 4 and modules must be thoroughly washed with freshwater within 2 hours and dried - especially the motors, gimbals, and camera.
- It is strongly advised to rinse the drone before any salt crystallizes.
- Motors are best rinsed by removing the propellers and immersing the motors one at a time into a bucket of warm fresh water and arming the drone in ATTI flight mode so the motors spin underwater.
- In the event of the SplashDrone 4 not being used for a long time, please store the drone and the batteries in a dry, and ventilated environment at 20°C~28°C.

Refer to the Maintenance manual for more maintenance information.

## Disclaimer and Warning

This product is not a toy and should only be operated by persons over the age of 18. Please keep it out of reach of children and pay particular attention to the possible scenarios of children unexpectedly appearing during flight operations.

Be sure to read this document carefully before using the product, to fully understand your legal rights, responsibilities, and safety instructions. Failure to do so may cause property damage, accidents, and personal injury. Once this product is used, it is deemed that you have understood, recognized, and have accepted all the terms and conditions of this statement.

The user is responsible for all the consequences of his actions and the use of the product. The user agrees to use the product for his sole & legal purpose and agrees with the terms & conditions of this agreement, and other relevant policies & guidelines that may be specified by SwellPro.

Under the maximum permitted by law and Approved circumstances, SwellPro accepts no liability for any indirect, punitive, consequential, special, or criminal damages, including the purchase cost, or loss of income due to the loss of use of the drone.

SwellPro is exempt from the user's liabilities for damage(s) to person/s or property, or injuries incurred directly or indirectly from the use of this product in the following conditions:

- Damage or injuries incurred when the user/s are under the influence of alcohol, drugs, or medication.

- Any malfunction caused by operators' failure to follow the guidance of the manual to assemble and set up or operate the drone as described and designed.
- Damage or injuries may occur due to failure to study the tutorial videos and the user manual before flying the drone.
- Damage or injuries caused to a person/s or property due to failure in correctly calibrating the drone as outlined in the manual before the flight.
- Damage or injuries incurred as a result of the use or installation of any unauthorized third-party accessories or counterfeit parts - which were not provided and Approved of by SwellPro.
- Damage or injuries as a result of flying the drone out of eyesight range, or more than 300m away from the controller.
- Damage or injuries caused by flying the drone in areas of magnetic fields & radio interference.
- Damage or injuries caused by flying in a NO-FLY ZONE that is regulated by local laws & rules.
- Damage or injuries including crashes, loss of control, or water ingress caused by abusing or modifying the original drone structure,
- Damage or injuries caused by using broken & aging components.
- Damage or injuries caused by continuing to fly the drone even if the low battery alarm is activated.
- Damage or injuries caused by failure to wash the components with fresh water after flying over or near the sea & corrosive waters.
- Damage or injuries that have occurred when the drone has been subjected to the following conditions or situations: collision, fire, explosion, floods, tsunamis, ice, snow, avalanche, flooding, landslide, earthquake, etc.
- Damage or injuries incurred by intentionally dropping or crashing the SplashDrone into the water from a high altitude, especially water ingress into the drone fuselage and gimbal malfunction.
- Damage or injuries incurred by intentionally dropping or crashing the SplashDrone to the ground or water from a high altitude, especially water leakage into the drone fuselage and gimbal frame as a result of this collision.
- Damage due to not follow the maintenance manual properly.
- Damage caused by operating the product at a weight greater than the safe takeoff weight, as specified by instruction manuals.
- For any reasons, the user cannot retrieve the drone for further diagnosis and examination.
- The user is not able or unwilling to provide the flight log to SwellPro for diagnosis and examination.
- Any attempt to modify flight log data noticed by SwellPro.
- Other Damage(s) or injuries that are not SwellPro's liability.

## Version Information

SwellPro products are constantly improving, so as the product user manuals. It is recommended to visit [support.swellpro.com](https://support.swellpro.com) to check and download the latest user manual.

## Version

### 1.0 SplashDrone 4 User Manual 1.0 Edition

#### 1.1 SplashDrone 4 User Manual 1.1 Edition

- Add Image Transmission reset guide.
- Add the use of mobile data in conjunction with Wi-Fi connection guide.

#### 1.2 SplashDrone 4 User Manual 1.2 Edition

- Add install battery notice.

##### 1.2.1 SplashDrone 4 User Manual 1.2.1 Edition

- Correct the remote controller charging state error.

##### 1.2.2 SplashDrone 4 User Manual 1.2.2 Edition

- Revise the description on pair & reset instructions.
- Revise the battery notice.

### 2.0 SplashDrone 4 User Manual 2.0 Edition

- Add the **Aircraft Antenna** section and **Remote Controller Antenna** section.

#### 2.0.1 SplashDrone 4 User Manual 2.0.1 Edition

- Add parts “When experiencing ... full responsibility” in the **Flight Safety and Environment** section.
- Add parts “Damage due to not following ... the flight log to SwellPro for diagnosis and examination.” in the **Disclaimer and Warning** section.

#### 2.1 SplashDrone 4 User Manual 2.1 Edition

- Revise the pairing instruction under the **Pairing Remote Controller** section.

#### 2.2 SplashDrone 4 User Manual 2.2 Edition

- Revise the pairing instruction under the **Pairing Remote Controller** section.

#### 2.3 SplashDrone 4 User Manual 2.3 Edition

- Revise multiple sections of the user manual.

##### 2.3.1 SplashDrone 4 User Manual 2.3.1 Edition

- Add propeller wobble notice on [Install Propellers](#) and [Pre-Flight Checklist](#).

##### 2.3.2 SplashDrone 4 User Manual 2.3.2 Edition

- Add the notice of SDFly 2 App on [Download the SDFly App](#).