



## UCONNECT 4C NAV WITH 12-INCH DISPLAY

---

# TABLE OF CONTENTS

SECTION		PAGE
1	SAFETY AND GENERAL INFORMATION .....	3
2	INTRODUCTION .....	13
3	RADIO MODE .....	21
4	MEDIA MODE .....	41
5	PHONE MODE .....	63
6	NAVIGATION MODE — IF EQUIPPED .....	83
7	VOICE RECOGNITION QUICK TIPS .....	145
8	UCONNECT + SIRIUSXM GUARDIAN .....	163



# SAFETY AND GENERAL INFORMATION

## CONTENTS

---

■ SAFETY GUIDELINES . . . . .	4	■ SECURITY FEATURES . . . . .	6
□ Safe Usage Of The Uconnect System . . . . .	4	□ Roadside Assistance Call — If Equipped . . . . .	6
□ Care And Maintenance . . . . .	5	□ SOS Call — If Equipped. . . . .	7
■ CYBERSECURITY . . . . .	5	■ REMOTE SERVICE FEATURES . . . . .	11
		■ SOFTWARE LICENSING INFORMATION . . . . .	11

**SAFETY GUIDELINES****WARNING!**

**ALWAYS drive safely with your hands on the steering wheel. You have full responsibility and assume all risks related to the use of the Uconnect features and applications in this vehicle. Only use Uconnect when it is safe to do so. Failure to do so may result in an accident involving serious injury or death.**

Ensure that all persons read this manual carefully before using the system. It contains instructions on how to use the system in a safe and effective manner.

**Do NOT attach any object to the touchscreen, doing so can result in damage to the touchscreen.**

Please read and follow these safety precautions. Failure to do so may result in injury or property damage.

- Glance at screen only when safe to do so. If prolonged viewing of the screen is required, park in a safe location and set the parking brake.

- Stop use immediately if a problem occurs. Failure to do so may cause injury or damage to the product. Return it to an authorized dealer to repair.
- Ensure the volume level of the system is set to a level that still allows you to hear outside traffic and emergency vehicles.

**Safe Usage Of The Uconnect System**

- Read all instructions in this manual carefully before using your system to ensure proper usage!
- Your system is a sophisticated electronic device. Do not let young children use your system.
- Permanent hearing loss may occur if you play your music or the system at loud volumes. Exercise caution when setting the volume on your system.
- Keep drinks, rain and other sources of moisture away from your system. Besides damage to your system, moisture can cause electric shocks as with any electronic device.

**NOTE:** Many features of this system are speed dependent. For your own safety, it is not possible to use some of the touchscreen features while the vehicle is in motion.

## Exposure To Radio Frequency Radiation

The internal wireless radio operates within guidelines found in radio frequency safety standards and recommendations, which reflect the consensus of the scientific community. The radio manufacturer believes the internal wireless radio is safe for use by consumers. The level of energy emitted is far less than the electromagnetic energy emitted by wireless devices such as mobile phones. However, the use of wireless radios may be restricted in some situations or environments, such as aboard airplanes. If you are unsure of restrictions, you are encouraged to ask for authorization before turning on the wireless radio.

## Care And Maintenance

### Touchscreen

- Do not press the touchscreen with any hard or sharp objects (pen, USB stick, jewelry, etc.) which could scratch the touchscreen surface!
- Do not spray any liquid or caustic chemicals directly on the screen! Use a clean and dry micro fiber lens cleaning cloth in order to clean the touchscreen.

- If necessary, use a lint-free cloth dampened with a cleaning solution, such as isopropyl alcohol or an isopropyl alcohol and water solution ratio of 50:50. Be sure to follow the solvent manufacturer's precautions and directions.

## CYBERSECURITY

Your vehicle may be a connected vehicle and may be equipped with both wired and wireless networks. These networks allow your vehicle to send and receive information. This information allows systems and features in your vehicle to function properly.

Your vehicle may be equipped with certain security features to reduce the risk of unauthorized and unlawful access to vehicle systems and wireless communications. Vehicle software technology continues to evolve over time and FCA US LLC, working with its suppliers, evaluates and takes appropriate steps as needed. Similar to a computer or other devices, your vehicle may require software updates to improve the usability and performance of your systems or to reduce the potential risk of unauthorized and unlawful access to your vehicle systems.

The risk of unauthorized and unlawful access to your vehicle systems may still exist, even if the most recent version of vehicle software (such as Uconnect software) is installed.

### WARNING!

- It is not possible to know or to predict all of the possible outcomes if your vehicle's systems are breached. It may be possible that vehicle systems, including safety related systems, could be impaired or a loss of vehicle control could occur that may result in an accident involving serious injury or death.
- ONLY insert media (e.g., USB, SD card, or CD) into your vehicle if it came from a trusted source. Media of unknown origin could possibly contain malicious software, and if installed in your vehicle, it may increase the possibility for vehicle systems to be breached.
- As always, if you experience unusual vehicle behavior, take your vehicle to your nearest authorized dealer immediately.

### NOTE:

- FCA US LLC or your dealer may contact you directly regarding software updates.
- To help further improve vehicle security and minimize the potential risk of a security breach, vehicle owners should:
  - Routinely check [www.driveuconnect.com/support/software-update.html](http://www.driveuconnect.com/support/software-update.html) (U.S. Residents) or [www.driveuconnect.ca](http://www.driveuconnect.ca) (Canadian Residents) to learn about available Uconnect software updates.
  - Only connect and use trusted media devices (e.g. personal mobile phones, USBs, CDs).

## SECURITY FEATURES

### Roadside Assistance Call — If Equipped

If your vehicle is equipped with this feature and within cellular range, you may be able to connect to Roadside Assistance Call, SiriusXM Guardian Customer Care, Uconnect Care Call and Vehicle Care Call by pressing the "ASSIST" button on the Rearview Mirror of your vehicle. To the extent any such calls incur additional costs, you are

responsible for them. If Roadside Assistance Call is provided to your vehicle, you agree to be responsible for any additional roadside assistance service costs that you may incur.

To provide SiriusXM Guardian services to you, we may record and monitor your conversations with Roadside Assistance Call, SiriusXM Guardian Customer Care, Uconnect Care Call or Vehicle Care Call, whether such conversations are initiated through the SiriusXM Guardian services in your vehicle, or via a landline or mobile telephone, and may share information obtained through such recording and monitoring in accordance with regulatory requirements. You acknowledge, agree and consent to any recording, monitoring or sharing of information obtained through any such call recordings.

### **SOS Call — If Equipped**

The SOS Call system is an embedded phone system that allows you to connect to an Emergency Services Agent in an emergency. You can choose to press the “SOS Call” button on the Rearview Mirror to contact an Emergency Services Agent.

### **SOS Call Operating Instructions**

1. Push the “SOS Call” button on the Rearview Mirror;

**NOTE:** In case the SOS Call button is pushed in error, there will be a ten second delay before the SOS Call system initiates a call to an Emergency Services Agent. To cancel the SOS Call connection, push the “SOS Call” button on the Rearview Mirror or press the “cancellation” button on the Phone Screen. Termination of the SOS Call will turn the green LED light on the Rearview Mirror off.

2. The LED light on the Rearview Mirror will turn green once a connection to an Emergency Services Agent has been made.
3. Once a connection between the vehicle and an Emergency Services Agent is made, the SOS Call system may transmit the following important vehicle information to a Emergency Services Agent:
  - Indication that the occupant placed a SOS Call.
  - The vehicle brand.
  - The last known GPS coordinates of the vehicle – if equipped.



## 8 SAFETY AND GENERAL INFORMATION

4. You should be able to speak with the Emergency Services Agent through the vehicle audio system to determine if additional help is needed.

### **WARNING!**

**ALWAYS** obey traffic laws and pay attention to the road. **ALWAYS** drive safely with your hands on the steering wheel. You have full responsibility and assume all risks related to the use of the features and applications in this vehicle. Only use the features and applications when it is safe to do so. Failure to do so may result in an accident involving serious injury or death.

### **NOTE:**

- Your vehicle may be transmitting data as authorized by the subscriber.
  - Once a connection is made between the vehicle's SOS Call system and the Emergency Services Agent, the Emergency Services Agent may be able to open a voice connection with the vehicle to determine if additional help is needed. Once the Emergency Services Agent opens a voice connection with the vehicle's SOS Call system, the operator should be able to speak with you or other vehicle occupants and hear sounds occurring in the vehicle. The vehicle's SOS Call system will attempt to remain connected with the Emergency Services Agent until the Emergency Services Agent terminates the connection.
5. The Emergency Services Agent may attempt to contact appropriate emergency responders and provide them with important vehicle information and GPS coordinates.

**WARNING!**

- If anyone in the vehicle could be in danger (e.g., fire or smoke is visible, dangerous road conditions or location), do not wait for voice contact from an Emergency Services Agent. All occupants should exit the vehicle immediately and move to a safe location.
- Never place anything on or near the vehicle's operable network and GPS antennas. You could prevent operable network and GPS signal reception, which can prevent your vehicle from placing an emergency call. An operable network and GPS signal reception is required for the SOS Call system to function properly.
- The SOS Call system is embedded into the vehicle's electrical system. Do not add aftermarket electrical equipment to the vehicle's electrical system. This may prevent your vehicle from sending a signal to initiate an emergency call. To avoid interference that can cause the SOS Call system to fail, never add aftermarket equipment (e.g., two-way mobile radio, CB radio, data recorder, etc.) to your vehicle's electrical system or modify the antennas on your vehicle. **IF YOUR VEHICLE LOSES BATTERY POWER FOR**

*(Continued)*

**WARNING! (Continued)**

**ANY REASON (INCLUDING DURING OR AFTER AN ACCIDENT), THE UCONNECT FEATURES, APPS AND SERVICES, AMONG OTHERS, WILL NOT OPERATE.**

- Modifications to any part of the SOS Call system could cause the air bag system to fail when you need it. You could be injured if the air bag system is not there to help protect you.

**SOS Call System Limitations**

If the SOS Call system detects a malfunction, any of the following may occur at the time the malfunction is detected, and at the beginning of each ignition cycle:

- The Rearview Mirror light will continuously be illuminated red.
- The Phone Screen will display the following message "Vehicle phone requires service. Please contact your dealer."
- An In-Vehicle Audio message will state "Vehicle phone requires service. Please contact your dealer."

**WARNING!**

- Ignoring the Rearview Mirror light could mean you will not have SOS Call services. If the Rearview Mirror light is illuminated, have an authorized dealer service the SOS Call system immediately.
- The Occupant Restraint Control module turns on the air bag Warning Light on the instrument panel if a malfunction in any part of the system is detected. If the Air Bag Warning Light is illuminated, have an authorized dealer service the Occupant Restraint Control system immediately.

Even if the SOS Call system is fully functional, factors beyond FCA US LLC's control may prevent or stop SOS Call system operation. These include, but are not limited to, the following factors:

- Delayed accessories mode is active.
- The ignition key is in OFF position.
- The vehicle's electrical systems are not intact.
- The SOS Call system software and/or hardware are damaged during a crash.

- The vehicle battery loses power or becomes disconnected during a vehicle crash.
- LTE (voice/data) or 3G or 4G (data) coverage and/or Global Positioning Satellite signals are unavailable or obstructed.
- Network congestion.
- Weather.
- Buildings, structures, geographic terrain, or tunnels.

**WARNING!**

**ALWAYS obey traffic laws and pay attention to the road. ALWAYS drive safely with your hands on the steering wheel. You have full responsibility and assume all risks related to the use of the features and applications in this vehicle. Only use the features and applications when it is safe to do so. Failure to do so may result in an accident involving serious injury or death.**

**NOTE:**

- Your vehicle may be transmitting data as authorized by the subscriber.
- Never place anything on or near the vehicle's and GPS antennas. You could prevent and GPS signal reception, which can prevent your vehicle from placing an emergency call. An operable network connection and a GPS signal is required for the SOS Call system to function properly.

**General Information**

The following regulatory statement applies to all Radio Frequency (RF) devices equipped in this vehicle:

This device complies with Part 15 of the FCC Rules and with Industry Canada license-exempt RSS standard(s). Operation is subject to the following two conditions:

1. This device may not cause harmful interference, and
2. This device must accept any interference received, including interference that may cause undesired operation.

**NOTE:** Changes or modifications not expressly approved by the party responsible for compliance could void the user's authority to operate the equipment.

**REMOTE SERVICE FEATURES**

For further information regarding Remote Service Features, refer to "Using SiriusXM Guardian" in the "Uconnect + Siriusxm Guardian — If Equipped" Chapter or go to your Owner Site.

**SOFTWARE LICENSING INFORMATION**

For software licensing information, please visit: <http://business.panasonic.com/solutions-automotivesolutions-opensource-fca>.



# INTRODUCTION

## CONTENTS

---

■ UCONNECT 4C NAV WITH 12-INCH DISPLAY . . . . .	.14	■ DRAG & DROP MENU BAR . . . . .	.18
■ IDENTIFYING YOUR RADIO . . . . .	.15	■ UCONNECT 4C NAV WITH 12-INCH DISPLAY SETTINGS . . . . .	.19

## UCONNECT 4C NAV WITH 12-INCH DISPLAY



**NOTE:** Uconnect screen images are for illustration purposes only and may not reflect exact software for your vehicle.

### 1. Media

Press the "Media" button on the touchscreen to access media sources such as: AM, FM, SiriusXM Satellite Radio (subscription or trial required), disc (if equipped) USB, AUX, and Bluetooth as long as the requested media is present.

### 2. Climate

Refer to Climate Controls in your vehicle's Owner's Manual for further details.

### 3. Controls

Press the "Controls" button on the touchscreen to adjust the auto-dimming mirror, heated & vented seats, heated & vented steering wheel (If Equipped).

#### 4. Apps

Press the “Apps”  button on the touchscreen to access Smartphone and Connected vehicle options.

#### 5. Nav

Press the “Nav” button on the touchscreen to access the Navigation feature. Refer to the Navigation section in this manual for further details.

#### 6. Phone

Press the “Phone” button on the touchscreen to access the Uconnect Phone feature.

**NOTE:** Interior trims may vary.

## IDENTIFYING YOUR RADIO

### Uconnect 4C NAV With 12-inch Display





## Key Features

The 4C NAV With 12-inch Display has the following features:

- 12" Touchscreen
- Hands-free/Bluetooth
- USB ports, and AUX jack — If Equipped
- Touchscreen Climate Controls
- Navigation Standard
- SiriusXM Satellite Radio with Trial Included — If Equipped
- Sirius Guardian Connected Services — If Equipped
- HD Radio

**NOTE:** 3D Landmarks are visible at 250 ft (76 m) and below, 3D City Models are visible at 50 ft (15 m) and below and Digital Terrain is visible at 100 mi and below.

## The Uconnect Voice Command And Uconnect Phone Buttons On Your Steering Wheel

The buttons let you use your voice to give commands, and make phone calls hands-free, enter navigation destinations and control your radio and media devices.

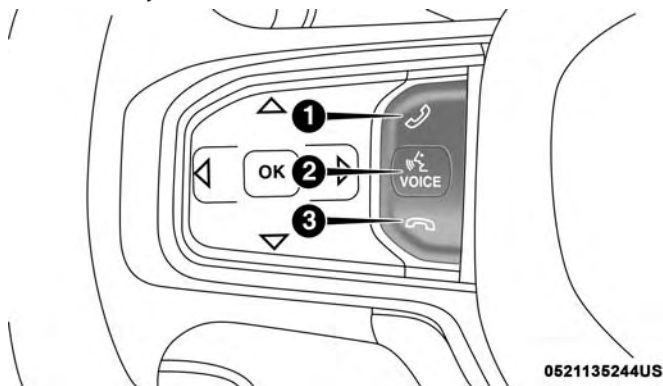

### Uconnect Voice Command Buttons

- 1 — Push To Initiate Or To Answer A Phone Call, Send Or Receive A Text
- 2 — Push To Begin Radio Or Media Functions
- 3 — Push To End Call

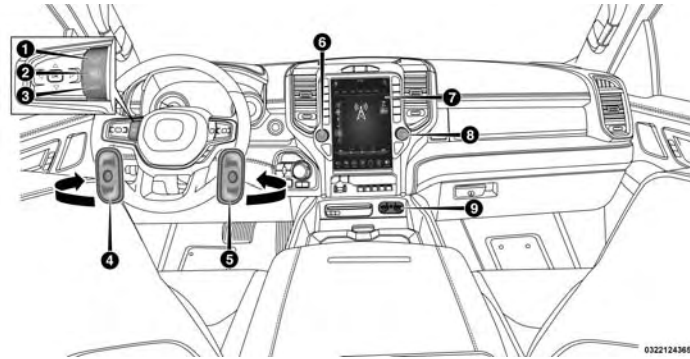

- 1 — Uconnect Phone Button
- 2 — Uconnect Voice Command Button
- 3 — Phone Hang Up Button
- 4 — Steering Wheel Audio Controls (Left Rear Surface of Steering Wheel)

- 5 — Steering Wheel Audio Controls (Right Rear Surface of Steering Wheel)
- 6 — Volume Knob
- 7 — Uconnect System
- 8 — Tune or Scroll Knob/Browse or Enter Button
- 9 — USB Ports and AUX port

**NOTE:** Interior trims may vary.

## DRAG & DROP MENU BAR

The Uconnect features and services in the main menu bar are easily changed for your convenience. Simply follow these steps:



Press the “Apps ” button to open the App screen.

Press and hold, then drag the selected App to replace an existing shortcut in the main menu bar.

The new app shortcut, that was dragged down onto the main menu bar, will now be an active App/shortcut.

**NOTE:** This feature is only available if the vehicle is in PARK.

## UCONNECT 4C NAV WITH 12-INCH DISPLAY SETTINGS



0322124363US

### 1 — Uconnect Buttons On The Touchscreen

Press the “Apps”  button on the touchscreen or press the “Settings” button in the upper right-hand corner of the touchscreen to display the menu setting screen. In this mode, the Uconnect system allows you to access all of your programmable features.

**NOTE:** Depending on the vehicle's options, available feature settings may vary.

When making a selection, press the button on the touchscreen to enter the desired mode. Once in the desired mode, press and release the preferred setting until a check-mark appears next to the setting, showing that setting has been selected. Once the setting is complete, either press the Back Arrow button on the touchscreen to return to the previous menu, or press the “X” button on the touchscreen to close out of the settings screen. Pressing the Up or Down Arrow button on the right side of the screen will allow you to toggle up or down through the available settings.

Refer to “Uconnect Settings” in the Owner’s Manual for further information.



# RADIO MODE

## CONTENTS

---

■ RADIO CONTROLS . . . . .	.22	□ Playhead Controls . . . . .	.33
□ Steering Wheel Audio Controls — If Equipped . . . . .	.24	□ Browse Channels . . . . .	.34
■ SETTING PRESETS . . . . .	.24	■ AUDIO . . . . .	.34
■ SIRIUSXM SATELLITE RADIO MODE — IF EQUIPPED . . . . .	.26		
□ SiriusXM with 360L— If Equipped . . . . .	.27		

## RADIO CONTROLS

The radio is equipped with the following modes:

- AM
- FM
- SiriusXM Satellite Radio (if equipped)

Press the MEDIA button on the touchscreen, bottom left corner, to enter the Media Mode. The different tuner modes; AM, FM, and SXM, can then be selected by pressing the corresponding buttons in the Media mode.

### VOLUME Control

Push the VOLUME control knob to turn on and off the Uconnect system.

The electronic volume control turns continuously (360 degrees) in either direction, without stopping. Turning the VOLUME control knob clockwise increases the volume, and counterclockwise decreases it.

### MUTE Button

Push the MUTE button to mute the system. Push the MUTE button again to unmute the system.

### TUNE/SCROLL Control

When the audio system is turned on, the sound will be set at the same volume level as last played.

Turn the rotary TUNE/SCROLL control knob clockwise to increase or counterclockwise to decrease the radio station frequency. Push the BROWSE/ENTER button to choose a selection.

### Screen Close

The X button on the touchscreen at the top right, provides a means to close the Direct Tune Screen. The Direct Tune Screen also auto closes if no activity occurs within 20 seconds.

### HD Radio

HD Radio technology (available only in the U.S. and Canadian markets) works similar to conventional radio except it allows broadcasters to transmit a high-quality digital signal. With an HD radio receiver, the listener is provided with a clear sound that enhances the listening experience. HD radio can also transmit data such as song title or artist.

## Seek And Direct Tune Functions

The Seek Up and Down functions are activated by pressing the double arrow buttons on the touchscreen to the right and left of the radio station display, or by pressing the left “Steering Wheel Audio Control” (if equipped) up or down.

### Seek Up▶▶

Press and release the “Seek Up” ▶▶ button on the touchscreen to tune the radio to the next listenable station or channel. During a Seek Up function, if the radio reaches the starting station after passing through the entire band two times, the radio will stop at the station where it began.

### Fast Seek Up

Press and hold the “Seek Up” ▶▶ button on the touchscreen to advance the radio through the available stations or channels at a faster rate, the radio stops at the next available station or channel when the button on the touchscreen is released.

### Seek Down◀◀

Press and release the “Seek Down” ◀◀ button on the touchscreen to tune the radio to the next listenable station or channel. During a Seek Down function, if the

radio reaches the starting station after passing through the entire band two times, the radio will stop at the station where it began.

### Fast Seek Down

Press and hold the “Seek Down” ◀◀ button on the touchscreen to advance the radio through the available stations or channel at a faster rate, the radio stops at the next available station or channel when the button on the touchscreen is released.

### Direct Tune

Press the “Tune” button on the touchscreen located at the bottom of the radio screen. The Direct Tune button on the touchscreen is available in AM, FM and SXM radio modes and can be used to direct tune the radio to a desired station or channel.

Press the available number button on the touchscreen to begin selecting a desired station. Once a number has been entered, any numbers that are no longer possible (stations that cannot be reached) will become deactivated/grayed out.



## Undo

You can backspace an entry by pressing the bottom left “Undo” button or the  button on the touchscreen.

## Steering Wheel Audio Controls — If Equipped

The remote sound system controls are located on the rear surface of the steering wheel. Reach behind the wheel to access the switches.

The right-hand control is a rocker-type switch with a push-button in the center and controls the volume and mode of the sound system. Pushing the top of the rocker switch will increase the volume, and pushing the bottom of the rocker switch will decrease the volume.

Pushing the center button will make the radio switch between the various modes available (AM/FM/SXM etc.).

The left-hand control is a rocker-type switch with a push-button in the center. The function of the left-hand control is different depending on which mode you are in.

The following describes the left-hand control operation in each mode.

## Radio Operation

Pushing the top of the switch will “Seek” up for the next listenable station and pushing the bottom of the switch will “Seek” down for the next listenable station.

The button located in the center of the left-hand control will tune to the next preset station that you have programmed in the radio preset button.

## Media Mode

Pushing the top of the switch once will go to the next track on the selected media (AUX, Bluetooth, USB). Pushing the bottom of the switch once will go to the beginning of the current track, or to the beginning of the previous track if it is within eight seconds after the current track begins to play.

If you push the switch up or down twice, it plays the second track; three times, it will play the third, etc.

## SETTING PRESETS

The Presets are available for all Radio Modes, and are activated by pressing any of the six “Preset” buttons on the touchscreen, located at the top of the screen.

When you are receiving a station that you wish to commit into memory, press and hold the desired numbered button on the touchscreen for more than two seconds or until you hear a confirmation beep.

The Radio stores up to 12 presets in each of the Radio modes. A set of six presets are visible at the top of the radio screen.

You can switch between the two radio presets by pressing the “arrow button” located in the upper right of the radio touchscreen.

### **Browse In AM/FM**

When in either AM or FM, the Browse Screen provides a means to edit the Presets List and is entered by pushing the ENTER/BROWSE button.

### **Scrolling Preset List**

Once in the Browse Presets screen, you can scroll the preset list by rotation of the TUNE/SCROLL knob, or by pressing the “Up and Down” arrow keys, located on the right of the screen.

### **Preset Selection From List**

A Preset can be selected by pressing any of the listed Presets, or by pushing the BROWSE/ ENTER button on the TUNE/SCROLL knob to select the currently highlighted Preset.

When selected, the radio tunes to the station stored in the Preset.

### **Deleting Presets**

A Preset can be deleted in the Presets Browse screen by pressing the “Trash Can” icon for the corresponding Preset.

### **Return To Main Radio Screen**

You can return to the Main Radio Screen, by pressing the “X” button, or the back arrow button, on the touchscreen when in the Browse Presets screen.

## **SIRIUSXM SATELLITE RADIO MODE — IF EQUIPPED**

SiriusXM Satellite Radio uses direct satellite-to-receiver broadcasting technology to provide clear, coast to coast radio content. SiriusXM is a subscription based service.

### **SiriusXM All Access Package**

All satellite radio equipped vehicles come with a trial to the SiriusXM All Access package. Get every channel available on your satellite radio, including all of your premium programming. Plus, listen to SiriusXM anywhere with over 160 channels on your computer, and smartphone and tablet with our app.

Go to [siriusxm.com/getallaccess](http://siriusxm.com/getallaccess) for more information

SiriusXM services require subscriptions, sold separately after the trial included with the new vehicle purchase. If you decide to continue your service at the end of your trial subscription, the plan you choose will automatically renew and bill at then-current rates until you call SiriusXM at 866-635-2349 to cancel. See SiriusXM Customer Agreement for complete terms at [www.siriusxm.com](http://www.siriusxm.com) (U.S. Residents)

or [www.siriusxm.ca](http://www.siriusxm.ca) (Canadian Residents) or call 888-539-7474 All fees and programming subject to change. Our satellite service is available only to those at least 18 and older in the 48 contiguous USA and D.C. Our SiriusXM satellite service is also available in PR (with coverage limitations). Our Internet radio service is available throughout our satellite service area and in AK. © 2018 SiriusXM Radio Inc. Sirius, XM and all related marks and logos are trademarks of SiriusXM Radio Inc.

This functionality is only available for radios equipped with a Satellite receiver. In order to receive satellite radio, the vehicle needs to be outside with a clear view to the sky.

If the screen shows Acquiring Signal, you might have to change the vehicle's position in order to receive a signal. In most cases, the satellite radio does not receive a signal in underground parking garages or tunnels.

### **No Subscription**

Radios equipped with a Satellite receiver, require a subscription to the SiriusXM Service. When the Radio does not have the necessary subscription, the Radio is able to receive the Pre-View channel only.

## Acquiring SiriusXM Subscription

To activate the SiriusXM Satellite Radio subscription, U.S. residents call:

1-800-643-2112

Canadian residents call:

1-877-438-9677

**NOTE:** You will need to provide the SiriusXM ID (RID) Radio ID.

The Satellite Mode is activated by a press of the “SXM” button on the touchscreen.

When in Satellite mode, the following features are displayed:

- The SXM button on the touchscreen is highlighted
- The vehicle presets are displayed.
- The Genre is displayed below the Channel Logo.
- The SiriusXM Channel Logo and Channel Number is displayed in the center.

- Show Name, Artist Name, and Song Title are displayed in the center of the screen below the Channel Number and Logo.
- The SiriusXM function buttons are displayed below near the Program Information.

Tuning is done by operating the Tune Knob or by Direct Tune, similar to other Radio Bands, see Presets, browse, Tune Knob, and Direct Tune.

In addition to the tuning Operation functions common to all Radio modes, the replay, Traffic/Weather Jump, and fav button functions are available in SiriusXM Mode.

## SiriusXM with 360L— If Equipped

The new SiriusXM with 360L delivers more content variety for all users including access to specific streaming channels and On Demand Content (once trial has expired, a purchased data plan will be required to receive streaming channels and On Demand Content). It allows you to have more control over your listening experience, as well as designing a customizable favorites menu of content, exactly how you want it. The system will recommend content based on your listening habits, providing endless listening options.

**Voice Search:**

Press the “Search” button and speak terms such as your favorite artist, sports team, talk show or celebrity. The personalized search results are ordered by relevancy to the search term spoken. The most relevant content is listed first based on listening history.

**Personalized Listening Experience:**

Recommendations (For You) are based each listeners’ listening habits. The recommendations can improve and grow through increased use. The more the listener listens, the better the recommendations get. Similar channels will also become easier to find based on their listening history.

**NOTE:** Additional capabilities (like Voice Search and Personalized recommendations) are available only when there is a data connection to the Cloud.

**Account Management:**

SiriusXM has made it easy for you to control your account from your vehicle. Some key account management features, now available to access from your vehicle, include:

- Subscribing to a SiriusXM audio service
- Setting up a login for online account center
- Creating SiriusXM listener profiles
- Updating your contact information
- Seeing the duration left in your SiriusXM trial and the status of your account

**Delivering Variety:**

Not only does SiriusXM offer over 160+ satellite channels in your car, you also get all Streaming Channels and On Demand Content. That way, you’ll never have to miss a favorite show. Diehard sports fans can easily find and follow favorite sports team on-the-go with the dedicated Live Sports Category. The feature has all NFL, MLB, NBA, NHL, college football and college basketball games. It broadcasts all games with national unbiased game calls when available.

## Enhanced Sports PxP And Live Sports Feature

Your favorite sports teams must be loaded onto your SiriusXM favorites bar, which are located under the Favorites menu item.

Tap and hold the League Logo on the Now Playing page. It will then display the Team Preset Modal which displays the teams for the play-by-play game current being broadcast.



To access the various sports teams:

1. Click on the Media icon on your touchscreen, and navigate to the SiriusXM icon on the left hand side of the screen.
2. Click the Categories icon below on the lower portion of the touchscreen where you will then be able to fine-tune your search by each separated category.
3. Under the Sports category you will then be able to locate your favorite team(s) and add them to your Favorites bar.

Within the individual Sports categories all Team channels are displayed as well as the generic sports channels. Under the Live Sports Category, all of the game that are in Pre-Game, In-Progress and Final state are shown and tuning happens automatically based off of available broadcasts and if the team(s) are in the user's SiriusXM Favorites.

Long press a Team Logo or Channel Logo and it will add/remove the team to your SiriusXM Favorites.

**NOTE:** Any teams which exist within your Favorites will be presented first in alphabetical order, before displaying Non-Favorite teams in alphabetical order. If the user has no favorite teams, the teams will be presented in alphabetical order only.

You will only be able to tune to Sport Games if the game state flag is in Pre-Game, In Progress, or Final Score mode. In all other cases, the No Games Modal, or Scheduled Game mode will be displayed.



1 — Satellite Vs. Streaming	2 — Navigation Map Overlap — if available
-----------------------------	---

3 — Notification Of Favorite Artists And Songs	4 — New Linear Tuner Plus Direct Tune Keypad
5 — Offboard VR For Finding Audio Content (Ex: "Detroit Tigers")	6 — Listener Profile And SiriusXM Setup Menu
7 — Other Related Content You May Like	8 — Move Backwards And Forward Within The Audio Buffer. Forward Button Changes To 'Live' At The Live Point. Refer To "Play Ahead Controls" Within This Section For Further Information.
9 — Super-Categories To Find Content (Ex: Ball Games) Quickly	10 — Anticipates And Recommends Content Based Off Of Your Listening History
11 — Long Press Any Channel Logo To Add To Favorite List. Presets Automatically Added To Favorite List Too	



## Adding Profiles Feature

SiriusXM created a listener profile feature that allows you to add/change/delete listener profiles. When switching users, favorites, vehicle presets, listening history, recommendations and personalized features will reflect the last selected listener profile by the driver.

If more than one SiriusXM profile has been created, when switching between Driver 1 and Driver 2 SiriusXM listener profiles, the vehicle preset bar will change/update automatically/accordingly. If only one SiriusXM listener profile exists, then the presets bar will not change.

**NOTE:** If there are no named listener profiles, the default listener avatar will be shown with text prompting you to create a listener profile.

To create a new listener profile (speed restricted feature):

1. From the profile and settings menu, select the 'Add Listener' option.
2. Begin adding a new listener profile by using the keyboard with whatever characters you choose.
3. Once tapping the next button, you can then choose from a set of eight generic avatars to further personalize your listener profile, and then touch the Done button.

**NOTE:** Users can download the SiriusXM smartphone App and use the RadioID for free access, if the subscription allows you to access SiriusXM content outside of your vehicle.

**NOTE:** Names and avatars can be changed at any given time, and the change will be reflected on all devices associated with the same Radio ID account.

4. Once you have selected an avatar, you will be returned to the profile and settings menu with the new listener profile you have just created selected.

**NOTE:** If an account already has five or more listeners, the option to 'Add Listener' will not be available.

The switch listener profile screen allows you to switch between existing listener profiles.

To delete a listener profile:

1. Tap on the listener profile you want to delete. Tap the "Delete Listener" button from the profiles setting menu located towards the bottom of the page.
2. A pop-up message will appear and mention that deleting the listener profile is not recoverable. If you are sure you want to continue, touch the Delete button.

**NOTE:** When deleting a listener profile: If only one listener profile – a new default listener profile will be created and you will be returned to the profile and settings menu showing the new default listener profile as active.

If two listener profiles – you will be returned to the listener profile and settings menu showing the new active listener profile.

If more than two listener profiles – you will be taken to the change/add listener profile screen and will need to select the listener profile you wish to use.

### **Playhead Controls**

The playhead function provides a means to play/pause, and skip backward/forward on the Now Playing screen.

#### **Play/Pause**

Press the “Pause/Play” button on the touchscreen to pause the playing of live or rewound content at any time. Play can be resumed again by pressing of the “Pause/Play” button on the touchscreen.

### **Skip Rewind**

By pressing the Skip Rewind (RW) button on the touchscreen, it does not rewind a set amount of time. It rewinds at segments, which for music channels is songs. Long press of the RW button will skip all the way back to the beginning of the buffer (up to one hour for SAT content and up to five hours for streaming content).

### **Skip Forward**

By pressing the “FW” button on the touchscreen, it does not go forward a set amount of time. It skips forward at segments, which for music channels is songs. Long press of the Skip Forward button will skip all the way to the LIVE point.

## Browse Channels

Browsing channels can be done via Categories or through the Linear Tuner/ Direct Turner. Editing your SiriusXM favorites can be done from the Favorites menu item.



To locate a desired channel, swipe either left or right to scan different stations.

## Artist & Song Alerts

The “Artist & Song Alerts” can be set from the Notify button on the Now Playing Screen and edited through the SiriusXM Profile & Settings.

## Tune Start

Tune Start begins playing the current song from the beginning when you tune to a music channel which is controlled by your SiriusXM Favorites for Satellite channel audio and ALL streaming channel audio. Tune Start can be turned on/off in the SiriusXM Profile & Settings.

## AUDIO

Press the “Audio” button on the touchscreen to activate the Audio settings screen to adjust Balance/Fade, Equalizer, Speed Adjusted Volume, Aux volume Offset, and Surround Sound.

You can return to the Radio screen by pressing the “X” located at the top right.

## Balance/Fade

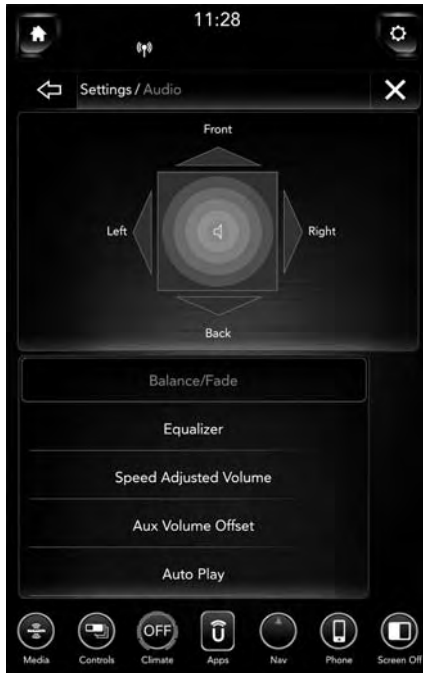

Press the “Balance/Fade” button on the touchscreen to Balance audio between the front speakers or fade the audio between the rear and front speakers.

Pressing the “Front,” “Rear,” “Left,” or “Right” buttons or press and drag the red Speaker Icon to adjust the Balance/Fade.

## Equalizer

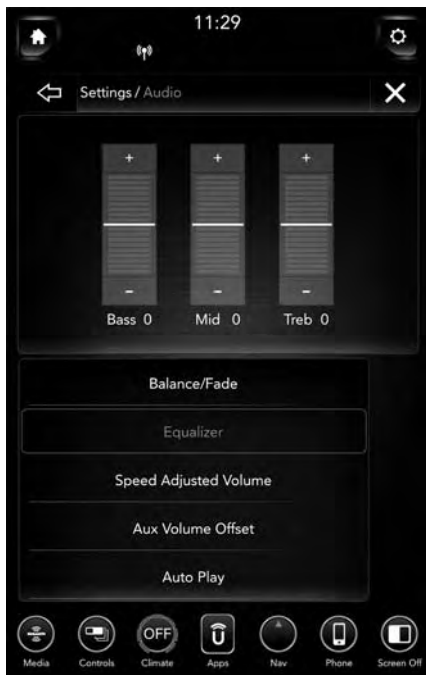

Press the “Equalizer” button on the touchscreen to activate the Equalizer screen.

Press the “+” or “-” buttons, or by pressing and dragging over the level bar for each of the equalizer bands. The level value, which spans between plus or minus nine, is displayed at the bottom of each of the Bands.

## Speed Adjusted Volume



Press the "Speed Adjusted Volume" button on the touchscreen to activate the Speed Adjusted Volume screen.

The Speed Adjusted Volume is adjusted by selecting from "Off," "1," "2" or "3." This alters the automatic adjustment of the audio volume with variation to vehicle speed. Volume increases automatically as speed increase to compensate for normal road noise.

## AUX Volume Offset

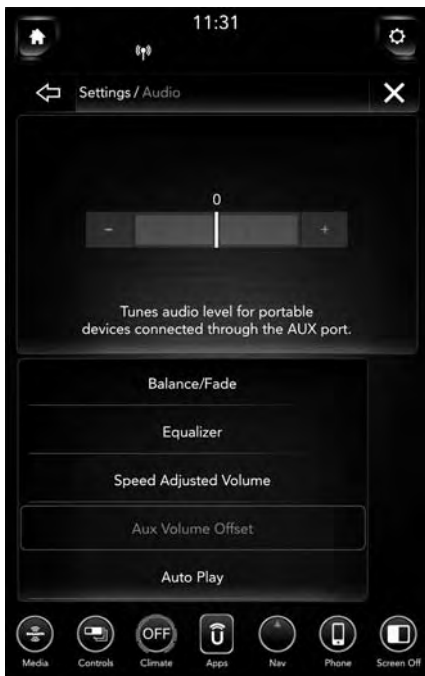

Press the “AUX Volume Offset” button on the touchscreen to activate the AUX Volume Offset screen.

The AUX Volume Offset is adjusted by pressing of the “+” and “-” buttons. This alters the AUX input audio volume. The level value, which spans between plus or minus three, is displayed above the adjustment bar.

## Auto Play

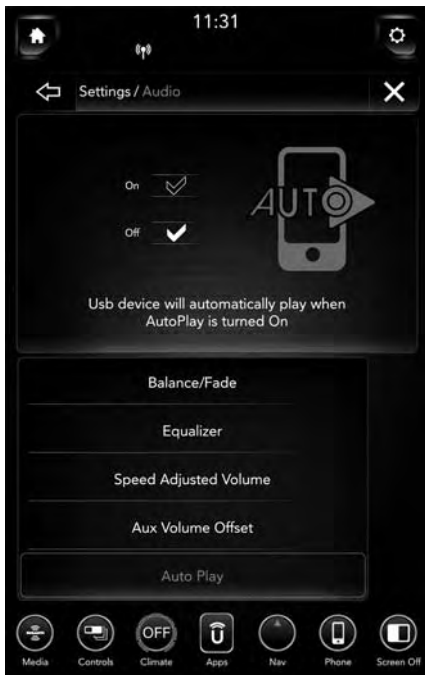

Press the “Auto Play” button on the touchscreen to activate the Auto Play screen.

The Auto Play feature begins playing music as soon as a USB Media device is connected to one of the vehicle’s Media USB ports, when it is turned on. Press “Off” to turn the setting off.





# MEDIA MODE

## CONTENTS

---

■ DISC MODE — IF EQUIPPED . . . . .	42	■ ANDROID AUTO & APPLE CARPLAY . . . . .	46
■ USB MODE . . . . .	43	□ Android Auto . . . . .	46
■ AUX MODE . . . . .	44	□ Apple CarPlay Integration . . . . .	53
■ BLUETOOTH MODE . . . . .	45	□ Android Auto And Apple CarPlay Tips And Tricks . . . . .	59

## DISC MODE — IF EQUIPPED

### Overview

Disc Mode is entered by either inserting a Disc or pressing the “Disc” button on the left side of the display. Once in Media Mode, press the “Source” button on the touchscreen and select “CD.”

A “Insert Disc” message will be displayed on the screen in the Disc mode when a Disc is not present in the Radio.

### Seek Up ►►/Seek Down◄◄

Press and release the Seek Up ►► button on the touchscreen for the next selection on the Disc. Press and release the Seek Down ◄◄ button on the touchscreen to return to the beginning of the current selection, or to return to the beginning of the previous selection if the Disc is within the first three seconds of the current selection.

### Browse

Press the “Browse” button on the touchscreen to display the browse window. The left side of the browse window displays a list of ways you can browse through the contents of the Disc. If supported by the device, you can browse by Folders, Artists, Playlists, Albums, Songs, etc. Press the

desired button on the touchscreen on the left side of the screen. The center of the browse window shows items and it’s sub-functions, which can be scrolled by pressing the “Up” and “Down” buttons to the right. The TUNE/SCROLL knob can also be used to scroll.

### Media Mode

Press the “Media” button on the touchscreen to select the desired audio source: Disc.

### Repeat

Press the “Repeat” button on the touchscreen to toggle the repeat functionality. The Repeat button on the touchscreen is highlighted when active. The Radio will continue to play the current track, repeatedly, as long as the repeat is active.

### Shuffle

Press the “Shuffle” button on the touchscreen to play the selections on the compact disc in random order to provide an interesting change of pace. Press the button on the touchscreen a second time to turn this feature off.

### Audio

Refer to Radio Mode for adjusting the audio settings.

## Info

Press the “Info” button on the touchscreen to display the current track information. Press the “Info” button on the touchscreen a second time to cancel this feature.

## Tracks

Press the “trks” button on the touchscreen to display a pop up with the Song List. The currently playing song is indicated by an arrow and lines above and below the song title. When in the Tracks List screen you can rotate the TUNE/SCROLL knob to highlight a track (indicated by the line above and below the track name) and then push the ENTER/BROWSE knob to start playing that track.

Pressing the “trks” button on the touchscreen while the pop up is displayed will close the pop up.

## USB MODE

### Overview

USB/iPod Mode is entered by either inserting a USB device or iPod and cable into the USB Port or press the “iPod” button on the left side of the display.

### Seek Up ►►/Seek Down◀◀

Press and release the Seek Up ►► button on the touchscreen for the next selection on the USB device/iPod. Press and release the Seek Down ◀◀ button on the touchscreen to return to the beginning of the current selection, or to return to the beginning of the previous selection if the USB device/iPod is within the first three seconds of the current selection.

### Browse

Press the “Browse” button on the touchscreen to display the browse window. The left side of the browse window displays a list of ways you can browse through the contents of the USB device/iPod. If supported by the device, you can browse by Folders, Artists, Playlists, Albums, Songs, etc. Press the desired button on the left side of the screen. The center of the browse window shows items and it's sub-functions, which can be scrolled by pressing the “Up” and “Down” buttons to the right. The TUNE/SCROLL knob can also be used to scroll.

**NOTE:** In USB mode, if the connect phone plays music by third party audio apps, there will be no “Browse” function.

## Media Mode

Press the “Media” button on the touchscreen to select the desired audio source: USB.

## Repeat

Press the “Repeat” button on the touchscreen to toggle the repeat functionality. The Repeat button on the touchscreen is highlighted when active. The Radio will continue to play the current track, repeatedly, as long as the repeat is active.

## Shuffle

Press the “Shuffle” button on the touchscreen to play the selections on the USB/iPod device in random order to provide an interesting change of pace. Press the “Shuffle” button on the touchscreen a second time to turn this feature off.

## Info

Press the “Info” button on the touchscreen to display the current track information. Press the “Info” button on the touchscreen a second time to cancel this feature.

## Tracks

Press the “trks” button on the touchscreen to display a pop up with the Song List. The currently playing song is

indicated by an arrow and lines above and below the song title. When in the “trks” List screen you can rotate the TUNE/SCROLL knob to highlight a track (indicated by the line above and below the track name) and then push the ENTER/BROWSE knob to start playing that track.

Pressing the “trks” button on the touchscreen while the pop up is displayed will close the pop up.

## Audio

Refer to Radio Mode for adjusting the audio settings.

## AUX MODE

### Overview

AUX (Auxiliary Mode) is entered by inserting an AUX device using a cable with a 3.5 mm audio jack into the AUX port or by pressing the AUX button on the left side of the display.

### Inserting Auxiliary Device

Gently insert the Auxiliary device cable into the AUX Port. If you insert an Auxiliary device with the ignition ON and the radio ON, the unit will switch to AUX mode and begin to play when you insert the device cable.

## Controlling The Auxiliary Device

The control of the auxiliary device (e.g., selecting playlists, play, fast forward, etc.) cannot be provided by the radio; use the device controls instead. Adjust the volume with the VOLUME And ON/OFF rotary knob, or with the volume of the attached device.

**NOTE:** The radio unit is acting as the amplifier for audio output from the Auxiliary device. Therefore, if the volume control on the Auxiliary device is set too low, there will be insufficient audio signal for the radio unit to play the music on the device.

## Media Mode

Press the “Media” button on the touchscreen to select the desired audio source: AUX.

## Audio

Refer to Radio Mode for adjusting the audio settings.

## BLUETOOTH MODE

### Overview

Bluetooth Streaming Audio (BTSA) or Bluetooth Mode is entered by pairing a Bluetooth device, containing music, to the Uconnect System.

Before proceeding, the Bluetooth device must be paired to the Uconnect Phone to communicate with the Uconnect System.

**NOTE:** See the pairing procedure in the Uconnect Phone section for more details.

To access Bluetooth mode, press the “Bluetooth” button on the left side of the display.

### Seek Up ►►/Down◀◀

Press and release the “Right Arrow” ►► button on the touchscreen for the next selection on the Bluetooth device. Press and release the “Left Arrow” ◀◀ button on the touchscreen to return to the beginning of the current selection, or return to the beginning of the previous selection if the Bluetooth device is within the first second of the current selection.

### Media Mode

Press the “Media” button on the touchscreen to select the desired audio source: Bluetooth.

### Tracks

If the Bluetooth device supports this feature, press the “trks” button on the touchscreen to display a pop up with

the Song List. The currently playing song is indicated by a red arrow and lines above and below the song title.

Pressing the “trks” button on the touchscreen while the pop up is displayed will close the pop up.

### **Audio**

Refer to Radio Mode for adjusting the audio settings.

## **ANDROID AUTO & APPLE CARPLAY**

### **Android Auto**

**NOTE:** Feature availability depends on your carrier and mobile phone manufacturer. Some Android Auto features may or may not be available in every region and/or language.

Android Auto is a feature of your Uconnect system, and your Android 5.0 Lollipop, or higher, powered smartphone with a data plan, that allows you to project your smartphone and a number of its apps onto the touchscreen radio display. Android Auto brings you useful information, and organizes it into simple cards that appear just when they are needed. Android Auto can be used with Google’s best-in-class speech technology, the steering wheel controls, the knobs and buttons on your radio faceplate, and the radio display’s touchscreen to control many of your apps. To use Android Auto follow the following procedure:

1. Download the Android Auto app from the Google Play store on your Android-powered smartphone.
2. Connect your Android powered smartphone to one of the media USB ports in your vehicle. If the Android Auto app was not downloaded, the first time you plug your device in, the app begins to download.

**NOTE:** Be sure to use the factory-provided USB cable that came with your phone, as aftermarket cables may not work.

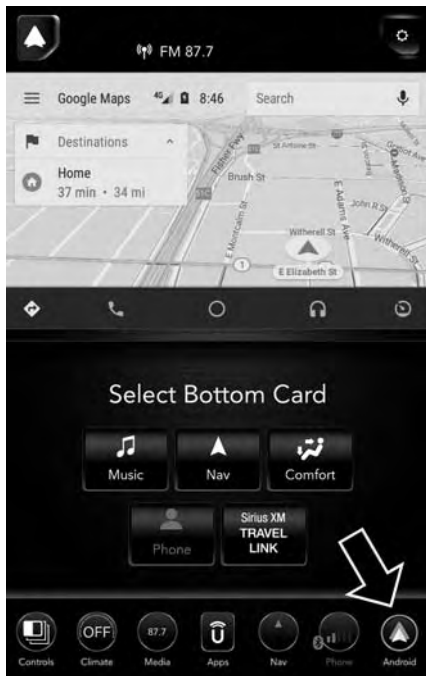

- Once the device is connected and recognized, the “Phone” icon on the drag & drop menu bar changes to the Android Auto Icon. Android Auto launches immediately, but if it not, refer to “Android Auto And Apple CarPlay Tips And Tricks” in this section for the procedure to enable the feature “AutoShow”. You can also launch it by touching the Android Auto icon on the touchscreen.

4

Once Android Auto is up and running on your Uconnect system, the following features can be utilized using your smartphone’s data plan:

- Google Maps for navigation
- Google Play Music, Spotify, iHeart Radio, etc. for music
- Handsfree Calling, and Texting for communication
- Hundred of compatible apps

**NOTE:** To use Android Auto, make sure you are in an area with cellular coverage. Android Auto may use cellular data and your cellular coverage is shown in the upper right corner of the radio screen.



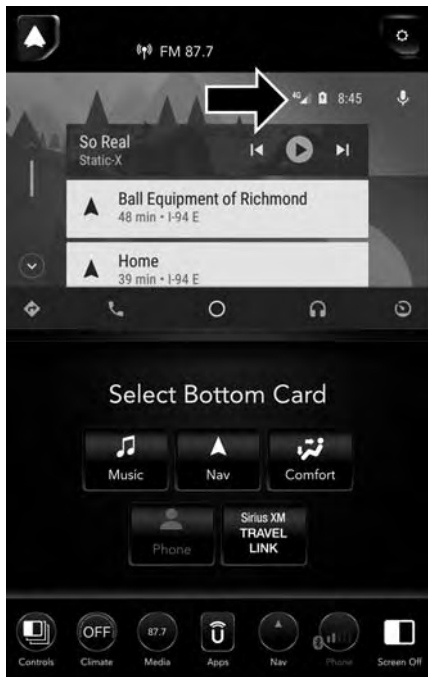

**NOTE:** Requires compatible smartphone running Android™ 5.0 Lollipop or higher and download app on Google Play. Android, Android Auto and Google Play are trademarks of Google Inc.

## Maps

Push and hold the VR button on the steering wheel or tap the microphone icon to ask Google to take you to a desired destination by voice. You can also touch the Navigation icon in Android Auto to access Google Maps.

**NOTE:** If the VR button is not held, and is only pushed, the built-in Uconnect VR prompts you and any navigation command said launches the built-in Uconnect navigation system.

While using Android Auto, Google Maps provides voice-guided:

- Navigation
- Live traffic information
- Lane guidance

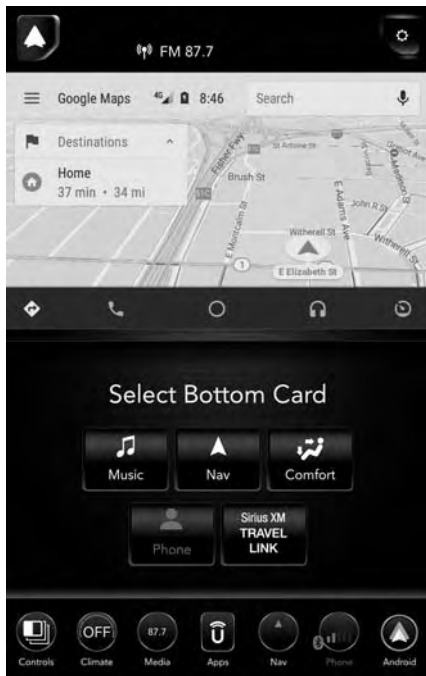

**NOTE:** If you are using the built-in Uconnect navigation system, and you try and start a new route using the Android Auto, via voice or any other method, a pop-up appears asking if you would like to switch from Uconnect navigation to smartphone navigation. A pop-up also appears, asking if you'd like to switch, if Android Auto is currently in use and you attempt to launch a built-in Uconnect route. Selecting "Yes" switches the navigation type to the newly used method of navigation and a route will be planned for the new destination. If "No" is selected the navigation type remains unchanged.



For further information, refer to [www.android.com/auto/](http://www.android.com/auto/) (U.S. Residents) or [www.android.com/intl/en\\_ca/auto/](http://www.android.com/intl/en_ca/auto/) (Canadian Residents).

For further information on the navigation function, please refer to <https://support.google.com/android> or <https://support.google.com/androidauto/>.

## Music

Android Auto allows you to access and stream your favorite music with apps like Google Play Music, iHeartRadio, and Spotify. Using your smartphone's data plan, you can stream endless music on the road.

**NOTE:** Music apps, playlists, and stations must be set up on your smartphone prior to using Android Auto, for them to work with Android Auto.

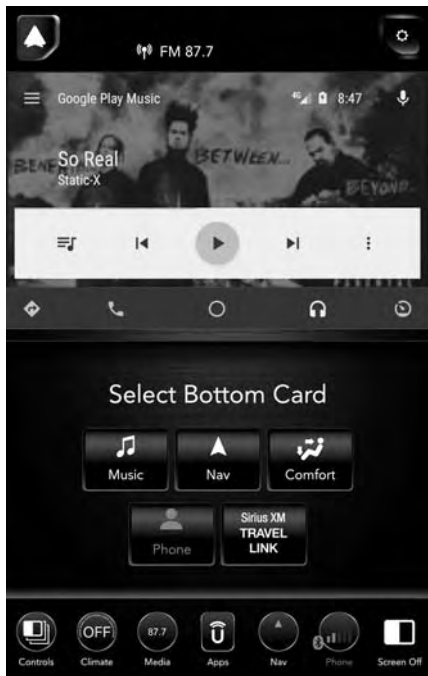

**NOTE:** To see the metadata for the music playing through Android Auto, select the Uconnect System's media screen.

For further information refer to <https://support.google.com/androidauto>.

### Communication

With Android Auto connected, press and hold the VR button on the steering wheel to activate voice recognition specific to the Android Auto. This allows you to send and reply to text messages, have incoming text messages read out loud, and place and receive hands-free calls.

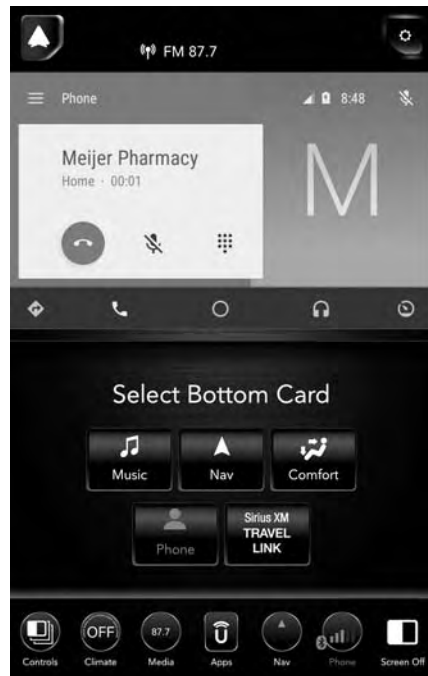
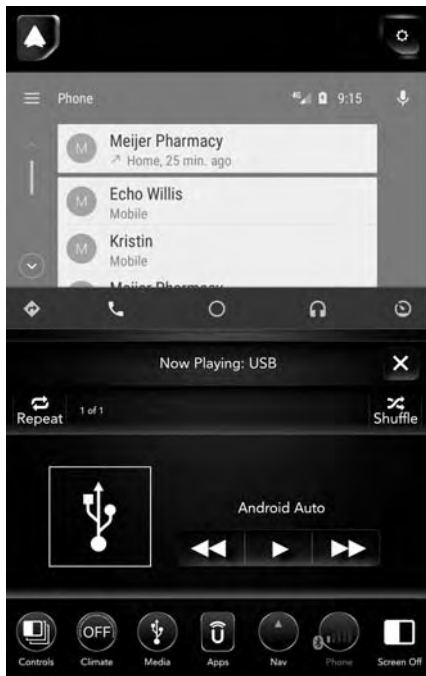

## Apps

The Android Auto App displays all the compatible apps that are available to use with Android Auto, every time it is launched. You must have the compatible app downloaded, and you must be signed in to the app for it to work with Android Auto. Refer to [g.co/androidauto](http://g.co/androidauto) to see the latest list of available apps for Android Auto.

### Apple CarPlay Integration

**NOTE:** Feature availability depends on your carrier and mobile phone manufacturer. Some Apple CarPlay features may or may not be available in every region and/or language.

Uconnect works seamlessly with Apple CarPlay, the smarter, more secure way to use your iPhone in the car, and stay focused on the road. Use your Uconnect Touchscreen display, the vehicle's knobs and controls, and your voice with Siri to get access to Apple Music, Maps, Messages, and more.

To use CarPlay, make sure you are using iPhone 5 or later, have Siri enabled in Settings, ensure your iPhone is unlocked for the very first connection only, and then use the following procedure:

1. Connect your iPhone to one of the media USB ports in your vehicle.

**NOTE:** Be sure to use the factory-provided Lightning cable that came with your phone, as aftermarket cables may not work.

2. Once the device is connected and recognized, the "Phone" icon on the drag & drop menu bar automatically changes to the CarPlay Icon. CarPlay launches automatically, but if not, refer to "Android Auto And Apple CarPlay Tips And Tricks" in this section for the procedure to enable the feature "AutoShow". You can also touch the Apple CarPlay icon on the touchscreen to launch it.

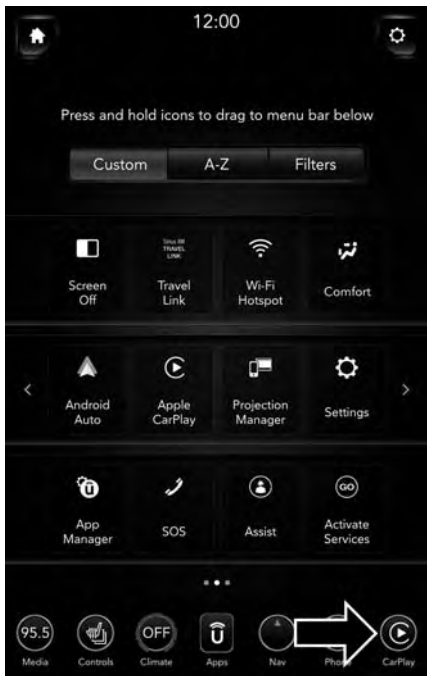

Once CarPlay is up and running on your Uconnect system, the following features can be utilized using your iPhone's data plan:

- Phone
- Music
- Messages
- Maps

**NOTE:** To use CarPlay make sure that cellular data is turned on, and that you are in an area with cellular coverage. Your data and cellular coverage is shown on the left side of the radio screen.

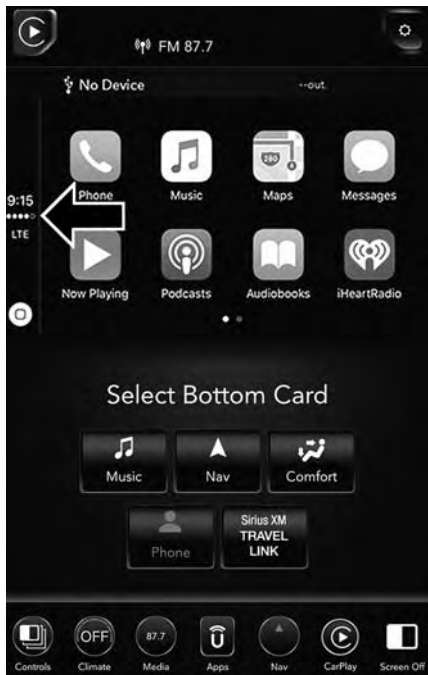

**NOTE:** Requires compatible iPhone. See dealer for phone compatibility. Data plan rates apply. Vehicle user interface is a product of Apple®. Apple CarPlay is a trademark of Apple Inc. iPhone is a trademark of Apple Inc., registered in the US and other countries. Apple terms of use and privacy statements apply.

## Phone



## Phone

With CarPlay, press and hold the VR button on the steering wheel to activate a Siri voice recognition session. You can also press and hold the Home button within CarPlay to start talking to Siri. This allows you to make calls or listen to voice mail as you normally would using

Siri on your iPhone.

**NOTE:** Only temporarily pushing the VR button on the steering wheel launches a built-in VR session, not a Siri session, and it will not function with CarPlay.



## Music



Music

CarPlay allows you to access all your artists, playlists, and music from iTunes. Using your iPhone's data plan, you can also use select third party audio apps including music, news, sports, podcasts and more.

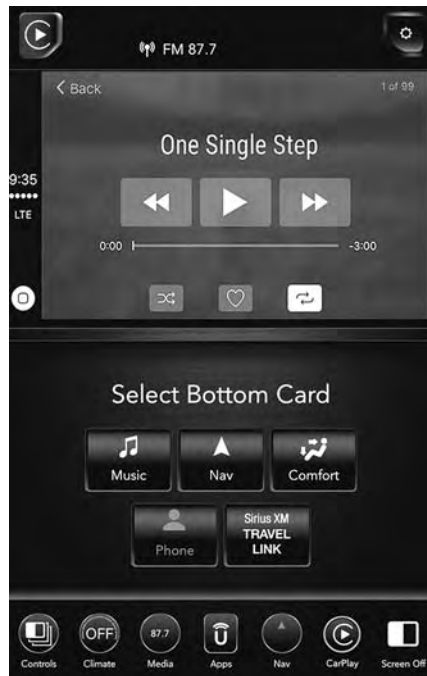

## Messages



## Messages

Just like Phone, CarPlay allows you to use Siri to send or reply to text messages. Siri can also read incoming text messages, but driver's will not be able to read messages, as everything is done via voice.

## Maps



## Maps

To use your Apple Maps for navigation on your Uconnect system, launch CarPlay, and push and hold the VR button on the steering wheel to use Siri to set your desired destination. Alternatively, choose a Nearby destination by pressing Destinations and selecting a category, by launching Siri from the destinations page, or even by typing in a destination.

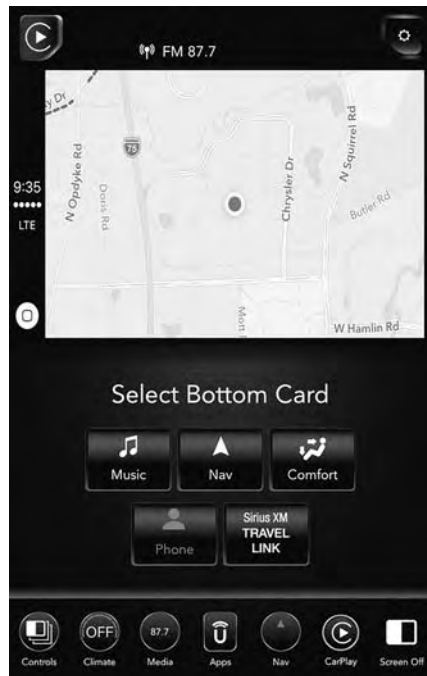

## NOTE:

- If the VR button is not held, and is only pushed, the built-in Uconnect VR prompts you and any navigation command said launches the built-in Uconnect navigation system.
- If you are using the built-in Uconnect navigation system, and you try and start a new route using CarPlay, via voice or any other method, a pop-up appears asking if you would like to switch from Uconnect navigation to iPhone navigation. A pop-up also appears, asking if you'd like to switch, if an CarPlay navigation is currently in use and you attempt to launch a built-in Uconnect route. Selecting "Yes" switches the navigation type to the newly used method of navigation and a route will be planned for the new destination. If "No" is selected the navigation type remains unchanged.

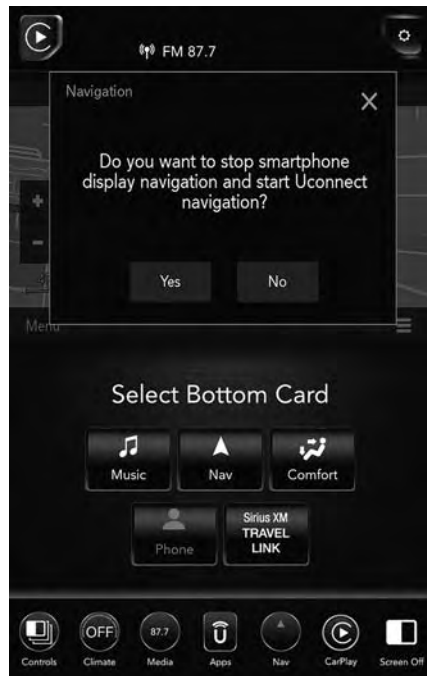

## Apps

To use a compatible app with CarPlay, you must have the compatible app downloaded, and you must be signed in to the app. Refer to [www.apple.com/ios/carplay](http://www.apple.com/ios/carplay) (U.S. Residents) or [www.apple.com/ca/ios/carplay](http://www.apple.com/ca/ios/carplay) (Canadian Residents) to see the latest list of available apps for CarPlay.

## Android Auto And Apple CarPlay Tips And Tricks

### AutoPlay

AutoPlay is a feature of the Uconnect system that automatically begins playing music off of the connected device, as soon as it is connected. This feature can be turned on or off in the Uconnect Settings, within the Audio Settings category. It's default setting is on.

**NOTE:** AutoPlay is not supported by Android Auto.

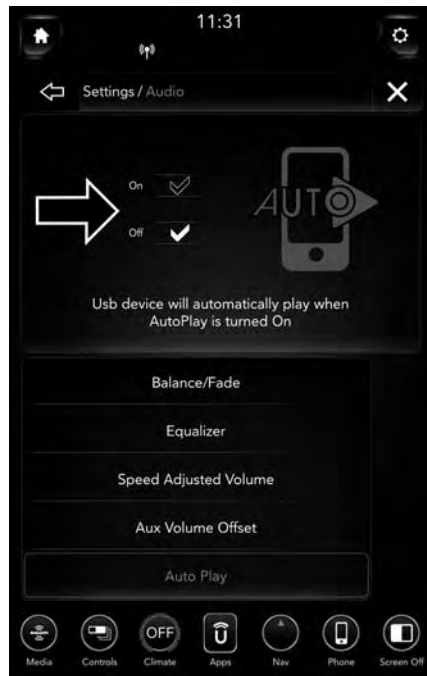

## Projection Manager

Projection Manager is a feature of the Uconnect system that automatically launches and displays Android Auto/Apple CarPlay when the phone is initially connected to the USB media port. This feature can be turned on and off in the Uconnect Settings, within the Display Settings category. The default setting is on.



## Android Auto Automatic Bluetooth Pairing

After connecting to Android Auto for the first time and undergoing the setup procedure, the smartphone will automatically pair to the Uconnect system via Bluetooth without any setup required every time it is within range, if Bluetooth is turned on.

**NOTE:** Android Auto features cannot be used with Bluetooth, a USB connection is required for its use. Android Auto uses both Bluetooth and USB connections to function, and the connected device will be unavailable to other devices when connected using Android Auto.

## Multiple Devices Connecting To The Uconnect System

It is possible to have multiple devices connected to the Uconnect system. For example, if using Android Auto/Apple CarPlay, the connected device will be the one that will be used to place hands-free phone calls or send hands-free text messages. However, another device can also be paired to the Uconnect system, via Bluetooth, as an audio source, so the passenger can stream music.

## NOTE:

- If using a Samsung device, every time it is connected to a media USB, and there is another device plugged in, you will need to manually change the configuration of the USB connection in order for the Samsung device to send data.
- The Uconnect 4C NAV built-in media functions will be unavailable when Android Auto/Apple CarPlay are in use.



# PHONE MODE

## CONTENTS

■ OVERVIEW	.65	□ Phonebook Download (Automatic Phonebook Transfer From Mobile Phone) — If Equipped	.74
■ PHONE OPERATION	.67	□ Managing Your Favorites	.74
□ Operation	.67	□ To Remove A Favorite	.75
□ Natural Speech	.68	■ PHONE CALL FEATURES	.75
□ Help Command	.68	□ Ways To Initiate A Phone Call	.75
□ Cancel Command	.68	□ Dial By Saying A Number	.75
□ Pair (Link) Uconnect Phone To A Mobile Phone	.68	□ Call By Saying A Phonebook Name	.76
□ Pair Additional Mobile Phones	.71	□ Call Controls	.76
□ Pair A Bluetooth Streaming Audio Device	.71	□ Touch-Tone Number Entry	.76
□ Connecting To A Particular Mobile Phone Or Audio Device After Pairing	.73	□ Recent Calls	.77
□ Disconnecting A Phone Or Audio Device	.73	□ Answer Or Ignore An Incoming Call — No Call Currently In Progress	.77
□ Deleting A Phone Or Audio Device	.73	□ Answer Or Ignore An Incoming Call — Call Currently In Progress	.77
□ Making A Phone Or Audio Device A Favorite	.73		



- Do Not Disturb . . . . .77
- Place/Retrieve A Call From Hold . . . . .78
- Making A Second Call While Current Call Is In Progress . . . . .78
- Toggling Between Calls . . . . .78
- Join Calls . . . . .78
- Call Termination . . . . .79
- Redial . . . . .79
- Call Continuation . . . . .79
- ADVANCED PHONE CONNECTIVITY . . . . .79
  - Transfer Call To And From Mobile Phone . . . . .79
  - Connect Or Disconnect Link Between The Uconnect Phone And Mobile Phone . . . . .79
- THINGS YOU SHOULD KNOW ABOUT YOUR UCONNECT PHONE . . . . .80
  - Voice Command . . . . .80
  - Far End Audio Performance . . . . .81
  - Bluetooth Communication Link . . . . .81
  - Power-Up . . . . .81
  - General Information . . . . .81

## OVERVIEW

Uconnect Phone is a voice-activated, hands-free, in-vehicle communications system. Uconnect Phone allows you to dial a phone number with your mobile phone.

Uconnect Phone supports the following features:

### Voice Activated Features:

- Hands-Free dialing via Voice (“Call John Smith Mobile” or, “Dial 248-555-1212”).
- Hands-Free text to speech listening of your incoming SMS messages.
- Hands-free Text Message Reply. (Forward one of 18 pre-defined SMS messages to incoming calls/text messages).
- Redialing last dialed numbers (“Redial”).
- Calling Back the last incoming call number (“Call Back”).
- View Call logs on screen (“Show incoming calls,” “Show Outgoing calls,” “Show missed Calls,” “Show Recent Calls”).
- Searching Contacts phone number (“Search for John Smith Mobile”).

### Screen Activated Features

- Dialing via Keypad using touchscreen.
- Viewing and Calling contacts from Phonebooks displayed on the touchscreen.
- Setting Favorite Contact Phone numbers so they are easily accessible on the Main Phone screen.
- Viewing and Calling contacts from Recent Call logs.
- Reviewing your recent Incoming SMS.
- Listen to Music on your Bluetooth Device via the touchscreen.
- Pairing up to ten phones/audio devices for easy access to connect to them quickly.

**NOTE:** Your phone must be capable of SMS messaging via Bluetooth for messaging features to work properly.

Your mobile phone’s audio is transmitted through your vehicle’s audio system; the system will automatically mute your radio when using the Uconnect Phone.

For Uconnect customer support:

- U.S. residents - visit [UconnectPhone.com](http://UconnectPhone.com) or call:  
877-855-8400
- Canadian residents - visit [UconnectPhone.com](http://UconnectPhone.com) or call:  
800-465-2001  
(English) or (French) call:  
800-387-9983
- Visit [UconnectPhone.com](http://UconnectPhone.com)

Uconnect Phone allows you to transfer calls between the system and your mobile phone as you enter or exit your vehicle and enables you to mute the system's microphone for private conversation.

### WARNING!

**ALWAYS drive safely with your hands on the steering wheel. You have full responsibility and assume all risks related to the use of the Uconnect features and applications in this vehicle. Only use Uconnect when it is safe to do so. Failure to do so may result in an accident involving serious injury or death.**



The Uconnect Phone is driven through your Bluetooth "Hands-Free Profile" mobile phone. Uconnect features Bluetooth technology - the global standard that enables different electronic devices to connect to each other without wires or a docking station, so Uconnect Phone works no matter where you stow your mobile phone (be it your purse, pocket, or briefcase), as long as your phone is turned on and has been paired to the vehicle's Uconnect Phone. The Uconnect Phone allows up to ten mobile phones or audio devices to be linked to the system. Only one linked (or paired) mobile phone and one audio device can be used with the system at a time.

### *Uconnect Phone Button*

The Uconnect Phone  button on your steering wheel is used to get into the phone mode and make calls, show recent, incoming, outgoing calls, view phonebook etc.,. When you press the button you will hear a BEEP. The beep is your signal to give a command.

### *Uconnect Voice Command Button*

The Uconnect Voice Command  button on your steering wheel is only used for “barge in” and when you are already in a call and you want to send Tones or make another call.

The  button on your steering wheel is also used to access the Voice Commands for the Uconnect Voice Command features if your vehicle is equipped. Please see the Uconnect Voice Command section for direction on how to use the  button.

The Uconnect Phone is fully integrated with the vehicle’s audio system. The volume of the Uconnect Phone can be adjusted either from the radio volume control knob or from the steering wheel radio control (right switch), if equipped.

## PHONE OPERATION

### Operation

Voice commands can be used to operate the Uconnect Phone and to navigate through the Uconnect Phone menu structure. Voice commands are required after most Uconnect Phone prompts. There are two general methods for how Voice Command works:

1. Say compound commands like “Call John Smith mobile.”
2. Say the individual commands and allow the system to guide you to complete the task.

You will be prompted for a specific command and then guided through the available options.

- Prior to giving a voice command, one must wait for the beep, which follows the “Listen” prompt or another prompt.
- For certain operations, compound commands can be used. For example, instead of saying “Call” and then “John Smith” and then “mobile”, the following compound command can be said: “Call John Smith mobile.”
- For each feature explanation in this section, only the compound command form of the voice command is given. You can also break the commands into parts and say each part of the command when you are asked for it. For example, you can use the compound command form voice command “Search for John Smith,” or you can break the compound command form into two voice commands: “Search Contact” and when asked “John Smith.” Please remember, the Uconnect Phone works

best when you talk in a normal conversational tone, as if speaking to someone sitting a few feet/meters away from you.

### Natural Speech

Your Uconnect Phone Voice system uses a Natural Language Voice Recognition (VR) engine.



Natural speech allows the user to speak commands in phrases or complete sentences. The system filters out certain non-word utterances and sounds such as “ah” and “eh.” The system handles fill-in words such as “I would like to.”

The system handles multiple inputs in the same phrase or sentence such as “make a phone call” and “to Kelly Smith.” For multiple inputs in the same phrase or sentence, the system identifies the topic or context and provides the associated follow-up prompt such as “Who do you want to call?” in the case where a phone call was requested but the specific name was not recognized.

The system utilizes continuous dialog; when the system requires more information from the user it will ask a question to which the user can respond without pushing the “Voice Command”  button on your steering wheel.



### Help Command

If you need assistance at any prompt, or if you want to know your options at any prompt, say “Help” following the beep.

To activate the Uconnect Phone from idle, simply push the Phone  button (if active) on your steering wheel and say a command or say “help.” All Uconnect Phone sessions begin with a push of the VR button or the Phone  button (if active) on the radio control head.

### Cancel Command

At any prompt, after the beep, you can say “Cancel” and you will be returned to the main menu.

You can also push the VR button  or Phone  button (if active) on your steering wheel when the system is listening for a command and be returned to the main or previous menu.

### Pair (Link) Uconnect Phone To A Mobile Phone

To begin using your Uconnect Phone, you must pair your compatible Bluetooth enabled mobile phone. Mobile phone pairing is the process of establishing a wireless connection between a cellular phone and the Uconnect system.

To complete the pairing process, you will need to reference your mobile phone Owner's Manual. Please visit [UconnectPhone.com](http://UconnectPhone.com) for complete mobile phone compatibility information.



#### NOTE:

- You must have Bluetooth enabled on your phone to complete this procedure.
  - The vehicle must be in PARK.
1. Place the ignition in the ACC or ON position.
  2. Press the “Phone” button in the Menu Bar on the touchscreen.
    - If there are no phones currently connected with the system, a pop-up will appear asking if you would like to pair a mobile phone.
  3. Select “Yes” to begin the pairing process.
  4. Search for available devices on your Bluetooth enabled mobile phone.
    - Press the Settings button on your mobile phone.
    - Select Bluetooth and ensure it is enabled. Once enabled, the mobile phone will begin to search for Bluetooth connections.

5. If No is selected, and you still would like to pair a mobile phone, press the “Pairing” button from the Uconnect Phone main screen.
  - Select “Paired Phones” then press the “Paired Phones and Audio Devices” button on the touchscreen, then press the “Add Device”.
  - Search for available devices on your Bluetooth enabled mobile phone (see below). When prompted on the phone, select “Uconnect” and accept the connection request.
6. Uconnect Phone will display an in progress screen while the system is connecting.
7. When your mobile phone finds the Uconnect system, select “Uconnect.”
8. When prompted on the mobile phone, accept the connection request from Uconnect Phone.
9. When the pairing process has successfully completed, the system will prompt you to choose whether or not this is your favorite phone. Selecting “Yes” will make this phone the highest priority. This phone will take precedence over other paired phones within range and will connect to the Uconnect system automatically when entering the vehicle. Only one mobile phone and/or one Bluetooth audio device can be connected to the Uconnect system at a time. If “No” is selected, simply select “Uconnect” from the mobile phone/audio device Bluetooth screen, and the Uconnect system will reconnect to the Bluetooth device.

**NOTE:** Some mobile phones will require you to enter the PIN number.

**NOTE:** Software updates on your phone or the Uconnect system may interfere with the Bluetooth connection. If this happens, simply repeat the pairing process. However, first, make sure to delete the device from the list of phones on your Uconnect system. Next, be sure to remove Uconnect from the list of devices in your phone’s Bluetooth settings.

## Pair Additional Mobile Phones

1. Press the “Settings” button on the touchscreen from the Phone main screen.
2. Press the “Add Device” button on the touchscreen.
3. Search for available devices on your Bluetooth enabled mobile phone. When prompted on the phone, enter the name and PIN shown on the Uconnect screen.
4. Uconnect Phone will display an in process screen while the system is connecting.
5. When the pairing process has successfully completed, the system will prompt you to choose whether or not this is your favorite phone. Selecting “Yes” will make this phone the highest priority. This phone will take precedence over other paired phones within range.

**NOTE:** For phones which are not made a favorite, the phone priority is determined by the order in which it was paired. The latest phone paired will have the higher priority.

You can also use the following VR commands to bring up the Paired Phone screen from any screen on the radio:

- “Show Paired Phones” or
- “Connect My Phone”

## Pair A Bluetooth Streaming Audio Device

1. Press the “Media” button on the touchscreen to begin.
  2. Change the Source to Bluetooth.
  3. Press the “Bluetooth” button on the touchscreen to display the Paired Audio Devices screen.
  4. Press the “Add Device” button on the touchscreen.
- NOTE:** If there is no device currently connected with the system, a pop-up will appear.
5. Search for available devices on your Bluetooth enabled audio device. When prompted on the device, enter the PIN shown on the Uconnect screen.
  6. Uconnect Phone will display an in process screen while the system is connecting.



7. When the pairing process has successfully completed, the system will prompt you to choose whether or not this is your favorite device. Selecting Yes will make this device the highest priority. This device will take precedence over other paired devices within range.

**NOTE:** For devices which are not made a favorite, the device priority is determined by the order in which it was paired. The latest device paired will have the higher priority.

You can also use the following VR command to bring up a list of paired audio devices.

- “Show Paired Phones” or
- “Connect My Phone”



## Connecting To A Particular Mobile Phone Or Audio Device After Pairing

Uconnect Phone will automatically connect to the highest priority paired phone and/or Audio Device within range. If you need to choose a particular phone or Audio Device follow these steps:

1. Press the "Pairing" button on the touchscreen.
2. Press the "Paired and Audio Devices" button on the touchscreen.
3. Press to select the particular Phone or the particular Audio Device. A pop-up menu will appear, press "Connect Phone."
4. Press the "X" to exit out of the Settings screen.

## Disconnecting A Phone Or Audio Device

1. Press the "Pairing" button on the touchscreen.
2. Press the "Paired Phones and Audio Devices" button on the touchscreen.
3. Press the "Settings" button located to the right of the device name.
4. The options pop-up will be displayed.

5. Press the "Disconnect Device" button on the touchscreen.
6. Press the "X" to exit out of the Settings screen.

## Deleting A Phone Or Audio Device

1. Press the "Pairing" button on the touchscreen.
2. Press the "Paired Phones and Audio Devices" button on the touchscreen.
3. Press the "Settings" button located to the right of the device name for a different Phone or Audio Device than the currently connected device.
4. The options pop-up will be displayed.
5. Press the "Delete Device" button on the touchscreen.
6. Press the "X" to exit out of the Settings screen.

## Making A Phone Or Audio Device A Favorite

1. Press the "Pairing" button on the touchscreen.
2. Press the "Paired Phones and Audio Devices" button on the touchscreen.
3. Press the "Settings" button located to the right of the device name.

4. The options pop-up will be displayed.
5. Press the “Make Favorite” button on the touchscreen; you will see the chosen device move to the top of the list.
6. Press the “X” to exit out of the Settings screen.

### **Phonebook Download (Automatic Phonebook Transfer From Mobile Phone) — If Equipped**

If equipped and specifically supported by your phone, Uconnect Phone automatically downloads names (text names) and number entries from the mobile phone’s phonebook. Specific Bluetooth Phones with Phone Book Access Profile may support this feature. See Uconnect website, [UconnectPhone.com](http://UconnectPhone.com), for supported phones.

- To call a name from a downloaded mobile phone book, follow the procedure in the “Uconnect Voice Recognition Quick Tips” section.
- Automatic download and update of a phone book, if supported, begins as soon as the Bluetooth wireless phone connection is made to the Uconnect Phone, for example, after you start the vehicle.

- A maximum of 5,000 contact names with four numbers per contact will be downloaded and updated every time a phone is connected to the Uconnect Phone.
- Depending on the maximum number of entries downloaded, there may be a short delay before the latest downloaded names can be used. Until then, if available, the previously downloaded phonebook is available for use.
- Only the phonebook of the currently connected mobile phone is accessible.
- This downloaded phonebook cannot be edited or deleted on the Uconnect Phone. These can only be edited on the mobile phone. The changes are transferred and updated to Uconnect Phone on the next phone connection.

### **Managing Your Favorites**

There are two ways you can add an entry to your Favorites.

1. After loading the mobile phonebook, press the “Favorites” button on the touchscreen, and then press one of the “+Add favorite Contact” buttons that appears on the list.

2. After loading the mobile phonebook, select “Contacts” from the Phone main screen, then select the appropriate number. Press the down arrow symbol button next to the selected number to display the options pop-up. In the pop-up select “Add to Favorites.”

**NOTE:** If the Favorites list is full, you will be asked to remove an existing favorite.

### To Remove A Favorite

1. To remove a Favorite, select “Favorites” from the Phone main screen.
2. Next select the down arrow icon next to the contact you want to remove from your favorites. This will bring up the options for that favorite contact.
3. Press “Remove from Favs.”

### PHONE CALL FEATURES

The following features can be accessed through the Uconnect Phone if the feature(s) are available and supported by Bluetooth on your mobile service plan. For example, if your mobile service plan provides three-way calling, this feature can be accessed through the Uconnect Phone. Check with your mobile service provider for the features that you have.

### Ways To Initiate A Phone Call

Listed below are all the ways you can initiate a phone call with Uconnect Phone.

- Redial
- Dial by pressing in the number
- Voice Commands (Dial by Saying a Name, Call by Saying a Phonebook Name, Redial or Call Back)
- Favorites
- Mobile Phonebook
- Recent Call Log
- SMS Message Viewer

### Dial By Saying A Number

1. Push the “VR” button on your steering wheel to begin.
2. After the “Listening” prompt and the following beep, say “Dial 151-123-4444.”
3. The Uconnect Phone will dial the number 151-123-4444.

## Call By Saying A Phonebook Name

1. Push the “VR” button on your steering wheel to begin.
2. After the “Listening” prompt and the following beep, say “Call John Doe Mobile.”
3. The Uconnect Phone will dial the number associated with John Doe, or if there are multiple numbers it will ask which number you want to call for John Doe.

## Call Controls

The touchscreen allows you to control the following call features:

- Answer
- End
- Ignore
- Hold/unhold
- Mute/unmute
- Transfer the call to/from the phone
- Swap two active calls
- Join two active calls together

## Touch-Tone Number Entry

1. Press the “Phone” button on the touchscreen.
2. Press the “Dial” button on the touchscreen.
3. The Touch-Tone screen will be displayed.
4. Use the numbered buttons on the touchscreens to enter the number and press “Call.”

If your vehicle has two buttons on the steering wheel (VR and Phone), press the VR  button on your steering wheel to send a touch-tone. If your vehicles has three buttons on the steering wheel (VR, Phone Send, and Phone End), press the Phone Send button on your steering wheel to send a touch-tone and say “Send 1234#” or you can say “Send Voicemail Password” if Voicemail password is stored in your mobile phonebook.

## Recent Calls

You may browse a list of the most recent of each of the following call types:

- All Calls
- Incoming Calls
- Outgoing Calls
- Missed Calls

These can be accessed by pressing the “recent calls” button on the Phone main screen.

You can also push the “VR” button on your steering wheel and say “Show my incoming calls” from any screen and the Incoming calls will be displayed.

**NOTE:** Incoming can also be replaced with “Outgoing,” “Recent” or “Missed.”

## Answer Or Ignore An Incoming Call — No Call Currently In Progress

When you receive a call on your mobile phone, the Uconnect Phone will interrupt the vehicle audio system. Push the Phone  button on the steering wheel to accept the call. You can also press the “answer” button on the touchscreen or press the caller ID box.

## Answer Or Ignore An Incoming Call — Call Currently In Progress

If a call is currently in progress and you have another incoming call, you will hear the same network tones for call waiting that you normally hear when using your mobile phone. Press the “Phone”  button on the steering wheel, answer button on the touchscreen or caller ID box to place the current call on hold and answer the incoming call.

**NOTE:** The Uconnect Phone compatible phones in the market today do not support rejecting an incoming call when another call is in progress. Therefore, the user can only answer an incoming call or ignore it.

## Do Not Disturb

With Do Not Disturb, you can disable notifications from incoming calls and texts, allowing you to keep your eyes on the road and hands on the wheel. For your convenience, there is a counter display to keep track of your missed calls and text messages while you were using Do Not Disturb.

Do Not Disturb can automatically reply with a text message, a call or both, when declining an incoming call and send it to voicemail.

Automatic reply messages can be:

- “I am driving right now, I will get back to you shortly.”
- Create a custom auto reply message up to 160 characters.

**NOTE:** Only the first 25 characters can be seen on the touchscreen while typing a custom message.

While in Do Not Disturb, Conference Call can be selected so you can still place a second call without being interrupted by incoming calls.

**NOTE:**

- Reply with text message is not compatible with iPhones.
- Auto reply with text message is only available on phones that support Bluetooth MAP.

### **Place/Retrieve A Call From Hold**

During an active call, press the “Hold” button on the Phone main screen.

### **Making A Second Call While Current Call Is In Progress**

You can place a call on hold by pressing the “Hold” button on the Phone main screen, then dial a number from the dialpad, recent calls, SMS Inbox or from the phonebooks. To go back to the first call, refer to “Toggling Between Calls” in this section. To combine two calls, refer to “Join Calls” in this section.

### **Toggling Between Calls**

If two calls are in progress (one active and one on hold), press the “Swap” button on the Phone main screen. Only one call can be placed on hold at a time.

You can also push the Phone  button to toggle between the active and held phone call.

### **Join Calls**

When two calls are in progress (one active and one on hold), press the “Join Calls” button on the Phone main screen to combine all calls into a Conference Call.

## Call Termination

To end a call in progress, momentarily press the Phone “End”  button on the touchscreen or the Phone “End” button on the steering wheel. Only the active call(s) will be terminated and if there is a call on hold, it will become the new active call.

## Redial

Press the “Redial” button on the touchscreen, or push the “VR” button and after the “Listening” prompt and the following beep, say “Redial.”

The Uconnect Phone will call the last number that was dialed from your mobile phone.

## Call Continuation

Call continuation is the progression of a phone call on the Uconnect Phone after the vehicle ignition has been switched to OFF.

**NOTE:** The call will remain within the vehicle audio system until the phone becomes out of range for the Bluetooth connection. It is recommended to press the “transfer” button on the touchscreen when leaving the vehicle.

## ADVANCED PHONE CONNECTIVITY

### Transfer Call To And From Mobile Phone

The Uconnect Phone allows ongoing calls to be transferred from your mobile phone to the Uconnect Phone without terminating the call. To transfer an ongoing call from your connected mobile phone to the Uconnect Phone or vice versa, press the “Transfer” button on the Phone main screen.

### Connect Or Disconnect Link Between The Uconnect Phone And Mobile Phone

If you would like to connect or disconnect the Bluetooth connection between a Uconnect Phone paired mobile phone and the Uconnect Phone, follow the instructions described in your mobile phone User’s Manual.



## THINGS YOU SHOULD KNOW ABOUT YOUR UCONNECT PHONE

### Voice Command

For the best performance:

- Adjust the rearview mirror to provide at least ½ inch (1 cm) gap between the overhead console (if equipped) and the mirror.
- Always wait for the beep before speaking.
- Speak normally, without pausing, just as you would speak to a person sitting a few feet/meters away from you.
- Ensure that no one other than you is speaking during a voice command period.

Performance is maximized under:

- Low-To-Medium Blower Setting
- Low-To-Medium Vehicle Speed
- Low Road Noise
- Smooth Road Surface

- Fully Closed Windows
- Dry Weather Condition

### WARNING!

**ALWAYS drive safely with your hands on the wheel. You have full responsibility and assume all risks related to the use of the Uconnect features and applications in this vehicle. Only use Uconnect when it is safe to do so. Failure to do so may result in an accident involving serious injury or death.**

Even though the system is designed for many languages and accents, the system may not always work for some.

**NOTE:** It is recommended that you do not store names in your favorites phonebook while the vehicle is in motion.

Phonebook (Mobile and Favorites) name recognition rate is optimized when the entries are not similar. You can say "O" (letter "O") for "0" (zero).

Even though international dialing for most number combinations is supported, some shortcut dialing number combinations may not be supported.

## Far End Audio Performance

Audio quality is maximized under:

- Low-To-Medium Blower Setting
- Low-To-Medium Vehicle Speed
- Low Road Noise
- Smooth Road Surface
- Fully Closed Windows
- Dry Weather Conditions
- Operation From The Driver's Seat

Performance such as audio clarity, echo, and loudness to a large degree rely on the phone and network, and not the Uconnect Phone.

Echo at the far end can sometimes be reduced by lowering the in-vehicle audio volume.

In a convertible vehicle, system performance may be compromised with the convertible top down.

## Bluetooth Communication Link

Mobile phones have been found to lose connection to the Uconnect Phone. When this happens, the connection can

generally be re-established by switching the mobile phone OFF/ON. Your mobile phone is recommended to remain in Bluetooth ON mode.

## Power-Up

After switching the ignition key from OFF to either the ON or ACC position, or after a language change, you must wait at least 15 seconds prior to using the system.

## General Information

The following regulatory statement applies to all Radio Frequency (RF) devices equipped in this vehicle:

This device complies with Part 15 of the FCC Rules and with Industry Canada license-exempt RSS standard(s). Operation is subject to the following two conditions:

1. This device may not cause harmful interference, and
2. This device must accept any interference received, including interference that may cause undesired operation.

**NOTE:** Changes or modifications not expressly approved by the party responsible for compliance could void the user's authority to operate the equipment.



# NAVIGATION MODE — IF EQUIPPED

## CONTENTS

---

■ OPERATING NAVIGATION . . . . .	85	□ Where To? — City Center . . . . .	120
■ WHERE TO? . . . . .	86	□ Where To? — Closest Cities . . . . .	121
□ Where To? — Main Menu . . . . .	86	□ Where To? — Phone . . . . .	123
□ Where To? — Quick Search . . . . .	88	□ Where To? — GEO Coordinate . . . . .	124
□ Where To? — Address . . . . .	90	□ Where To? — Trails . . . . .	125
□ Where To? — Recent . . . . .	92	□ Before Route Guidance . . . . .	126
□ Where To? — Favorite Destinations . . . . .	95	■ VIEW MAP . . . . .	129
□ Where To? — Point of Interest . . . . .	97	□ View Map — Settings . . . . .	129
□ Where To? — Trips . . . . .	113	■ HOME . . . . .	131
□ Where To? — Intersection . . . . .	115	□ Navigating Home. . . . .	131
□ Where To? — Point on Map . . . . .	116	■ WORK . . . . .	131
□ Where To? — Home . . . . .	118	□ Navigating To Work . . . . .	131
□ Where To? — Work . . . . .	119		

■ INFORMATION . . . . .	131	□ Emergency — Hospital . . . . .	137
□ Information — Main Menu . . . . .	131	□ Emergency — Police . . . . .	138
□ Information — SiriusXM Traffic Plus . . . . .	132	□ Emergency — Fire Department . . . . .	140
□ Information — Where Am I? . . . . .	133	■ MAP UPDATES . . . . .	141
□ Information — Trip Computer . . . . .	134	■ SIRIUSXM TRAFFIC PLUS . . . . .	142
□ Information — Country Info . . . . .	135	■ SIRIUSXM TRAVEL LINK . . . . .	142
■ EMERGENCY . . . . .	136		
□ Emergency — Main Menu . . . . .	136		

## OPERATING NAVIGATION

To access the Navigation system, press the "Nav" button on the touchscreen.



- Press "Where To?" to find or route to a destination.
- Press "Where To?" and then press "Home" to set a home address, if not already set, and to program a route home.
- Press "Where To?" and then press "Work" to set a work address, if not already set, and to program a route to work.
- Press "Information" to view Traffic, Where Am I? and Trip Computer information.
- Press "Where To?" and then press "Emergency" to search for Hospitals, Police and Fire Stations near your current location. You can also display your current location and save any Emergency facility location to your Favorites.
- Press the search bar at the top of the screen to search for a specific address to program a route to.

## WHERE TO?

### Where To? — Main Menu

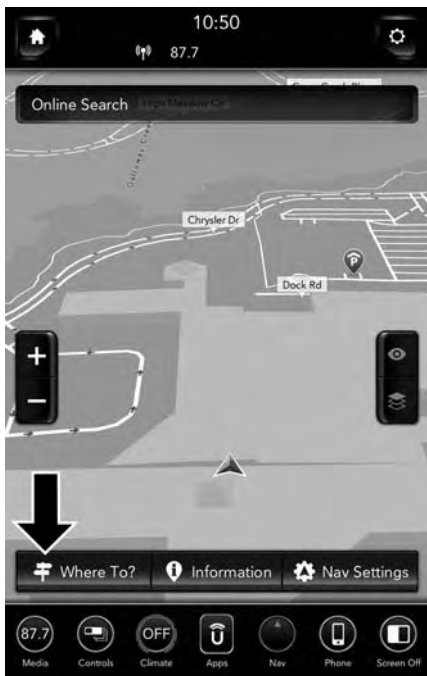

From the Nav Main Menu, press the “Where To?” button on the touchscreen and select one of the following methods to program a route guidance.

**NOTE:** Refer to the individual section of the chosen option for further information.

#### Quick Search

Press this button on the touchscreen to quick search “Where To?” categories for a location.

#### Address

Press this button on the touchscreen to search by a street address or a street name with house number.

#### Recent

Press this button on the touchscreen to access previously routed addresses or locations.

#### Favorites

Press this button on the touchscreen to access previously saved addresses or locations.

### **Point of Interest**

Press this button on the touchscreen when you want to route to a point of interest. The Point of Interest (POI) database allows you to select a destination from a list of locations and public places, or points of interest.

### **Trips**

Press this button on the touchscreen to program a new trip or recall a saved trip.

### **Intersection**

Press this button on the touchscreen to enter in two street names as a destination.

### **Point on Map**

Press this button on the touchscreen to select a destination directly from the Map screen. By selecting a street segment or icon, you can quickly enter a destination without the need to input the city name or street.

### **Home**

Press this button on the touchscreen to program or confirm a route to the saved home address.

### **Work**

Press this button on the touchscreen to program or confirm a route to the saved work address.

### **City Center**

Press this button on the touchscreen to route to a particular city. The navigation system will calculate a route with the destination at the center of the city.

### **Closest Cities**

Press this button on the touchscreen to route to a nearby city. The screen will display an alphabetical listing of nearby cities. The navigation system will calculate a route with the destination at the center of the nearby city.

### **Phone Number**

Press this button on the touchscreen to route to a location or point of interest by the phone number.

### **GEO Coordinates**

Press this button on the touchscreen to route to a GEO Coordinate. A geo coordinate is a coordinate used in geography. You can determine a geo coordinate with the help of a handheld GPS receiver, a map, or the navigation system.



## Trails

Press the “Trails” button on the touchscreen and select the option to start trail recording to track the route you are driving. Select the option to “stop trail recording” to end tracking. This gives you a point of reference to for a particular route if needed.

## Edit Where To?

Press this button on the touchscreen and select which “Where To?” categories you would like to appear in the “Where To?” menu, and which ones you don’t.

**NOTE:** You can press the “back” arrow button on the touchscreen to return to the previous screen or the “X” button on the touchscreen to exit.

## Where To? — Quick Search

To search all the “Where To?” categories for a location, follow these steps:

1. While in the Nav Main Menu, press the “Where To?” button on the touchscreen, then press the “Quick Search” button on the touchscreen.



2. Enter the location name, street address, city, etc. you wish to search for, to search all “Where To?” categories for the entered location, and press “OK.”



3. Select the desired location from the list of locations that appears. Once the correct location has been selected, you will be asked to confirm your route by pressing “GO.”



4. Press the “GO” button on the touchscreen to begin your route.

If you are currently on a route guidance and you select Recent, the system asks you to choose one of the following:

- Cancel previous route
- Add to Current Route

Within “Add to Current Route” you can add the destination to your current route, or set it as the final destination.

**NOTE:** You can press the “back arrow” button on the touchscreen to return to the previous screen or the “X” button on the touchscreen to exit.

### Where To? — Address

To enter a destination by Address, follow these steps:

1. While in the Nav Main Menu, press the “Where To?” button on the touchscreen, then press the “Address” button on the touchscreen.



- Press “Street Name or City Name” to begin entering the address of your destination.



If you press “City Name,” you will have to enter and select/press the desired city name, followed by the desired street name then the house number.

If you press “Street Name,” you will have to enter and select/press the desired street name in the correct city and then you will have to enter the house number.

To change the state and/or country, press the “state, country” button on the touchscreen and follow the prompts to change the state and/or country.



Once the correct City, Street and Number has been entered, you will be asked to confirm your route by pressing "Route To."

3. Press the "GO" button on the touchscreen to confirm your destination and begin your route.

If you are currently on a route guidance and you select Recent, the system asks you to choose one of the following:

- Cancel previous route
- Add to Current Route

Within "Add to Current Route" you can add the destination to your current route, or set it as the final destination.

**NOTE:** You can press the "back arrow" button on the touchscreen to return to the previous screen or the "X" button on the touchscreen to exit.

### Where To? — Recent

To route to a Recent destination, follow these steps:

1. While in the Nav Main Menu, press the "Where To?" button on the touchscreen, then press the "Recent" button on the touchscreen.



2. Press the button on the touchscreen with the name of the desired destination.



- To display the options for a destination from the list, press the "..." button on the touchscreen, which opens a pop-up menu with the options for that destination.

## 94 NAVIGATION MODE — IF EQUIPPED

To delete a destination from the list, press “Delete” in that pop-up menu.



The following Options are available for each destination:

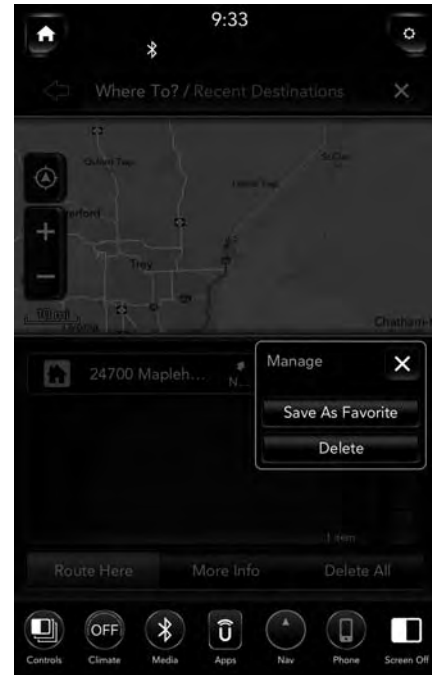

- Save as Favorite
- Delete

3. Select “Route To” to confirm your route.
4. Press “GO” to confirm your destination, and begin your route.

If you are currently on a route guidance and you select a Intersection, the system asks you to choose one of the following:

- Cancel previous route
- Add to Current Route

Within “Add to Current Route” you can add the destination to your current route, or set it as the final destination.

**NOTE:** You can press the “back arrow” button on the touchscreen to return to the previous screen or the “X” button on the touchscreen to exit.

### Where To? — Favorite Destinations

To route to a Favorite destination, follow these steps:

1. While in the Nav Main Menu, press the “Where To?” button on the touchscreen, then press the “Favorites” button on the touchscreen.





2. Press the button on the touchscreen with the name of the desired favorite destination and confirm the route with “Route To.” Press “GO” to confirm the destination, and start the route guidance.
3. To delete a destination from the list, press the “...” button next to the destination and select “Delete” in the pop-up menu on the touchscreen.
4. To save a favorite destination, press the “Add Favorite” button on the touchscreen and follow the steps to route a destination.
5. To display the options for a favorite destination press the “Options” button on the touchscreen.

The following Options are available for each favorite destination:

- Edit Name
- Phone Number
- Move Up
- Move Down
- Delete

If you are currently on a route guidance and you select a Favorite, the system asks you to choose one of the following:

- Cancel previous route
- Add to Current Route

Within “Add to Current Route” you can add the destination to the current route, or set it as your final destination.

**NOTE:** You can press the “back arrow” button on the touchscreen to return to the previous screen or the “X” button on the touchscreen to exit.

## Where To? — Point of Interest

To enter a destination by Point of Interest (POI), press the “Where To?” button from the Nav Main Menu, then press the “Point of Interest” button on the touchscreen.



The Point of Interest database allows you to select a destination from a list of locations and public places, or points of interest.

You have the following POIs to choose from:

- ATM/Bank
- Automotive
- Coffee Shops
- Community
- Entertainment
- Gas Stations
- Hotels Or Motels and more
- Local Services
- Medical



You can also change your POI search area, by pressing any of the category buttons on the touchscreen, and pressing the “Around Here” button. You have the following options to change your search area:

- Around Here
- In a City or Zip Code
- Along Route (only available during route guidance)
- Around Destination (only available during route guidance)
- Around Next Waypoint



**NOTE:** You can press the “back arrow” button on the touchscreen to return to the previous screen or the “X” button on the touchscreen to exit.

## POI — Search By Name

To select for a specific POI, follow these steps:

1. While in the Nav Main Menu, press the “Where To?” button on the touchscreen, then press the “Points Of Interest” button on the touchscreen.



2. Press the “Search By Name” button on the touchscreen.

3. A keyboard appears on the screen. Type in the POI that you want to search and press the “List” button on the touchscreen to display available items.
4. Press the desired POI and press “Route To” to confirm the route.
5. Press the “GO” button to confirm the destination and begin the route.

If you are currently on a route guidance and you select a POI, the system asks you to choose one of the following:

- Cancel previous route
- Add to Current Route

Within “Add to Current Route” you can add the destination to the current route, or set it as the final destination.

**NOTE:** You can press the “back arrow” button on the touchscreen to return to the previous screen or the “X” button on the touchscreen to exit.

## POI — POI Categories

To select a POI type, follow these steps:

1. While in the Nav Main Menu, press the “Where To?” button on the touchscreen, then press the “Point of Interest” button on the touchscreen.



2. Press “POI Categories” button on the touchscreen.



You can search through the available POI categories to find your desired POI.

The available categories are:

- List All POIs
- ATM or Banking
- Automotive
- Coffee Shops
- Community
- Entertainment
- Gas Stations
- Highway Exit
- Hotels or Motels
- Local Services
- Medical
- Parking
- Parks and Recreation
- Restaurants
- Shopping
- Travel and Transportation





3. Select a category and then select a subcategory if necessary. Press the “List All POIs” button on the touchscreen to search within the POI categories.
4. Press the desired POI and press “Route To” to confirm the route.
5. Press the “GO” button to confirm the destination and begin the route.

If you are currently on a route guidance and you select a POI, the system asks you to choose one of the following:

- Cancel previous route
- Add to Current Route

Within “Add to Current Route” you can add the destination to your current route, or set it as the final destination.

**NOTE:** You can press the “back arrow” button on the touchscreen to return to the previous screen or the “X” button on the touchscreen to exit.

### POI — Restaurants

To select a Restaurant POI, follow these steps:

1. While in the Nav Main Menu, press the “Where To?” button on the touchscreen, then press the “Point of Interest” button on the touchscreen.



2. Press the “Restaurants” button on the touchscreen.



You can search for a restaurants by the following categories, which are button tabs at the top of the screen.

- Name
- Distance
- ABC (Search)

3. Press the desired Restaurant and press “Route To” to confirm the route.
4. Press the “GO” button to confirm the destination and begin route.

If you are currently on a route guidance and you select a Restaurant, the system asks you to choose one of the following:

- Cancel previous route
- Add to Current Route

Within “Add to Current Route” you can add destination into your current route, or set the destination as your final destination.

**NOTE:** You can press the “back arrow” button on the touchscreen to return to the previous screen or the “X” button on the touchscreen to exit.

## POI — Hotels/Motels

To select a Hotel or Motel POI, follow these steps:

1. While in the Nav Main Menu, press the “Where To?” button on the touchscreen, press the “Point of Interest” button on the touchscreen.



2. Press “POI Categories” and then press the “Hotels or Motels” button on the touchscreen.



You can search for a hotel or motel by the following categories, which are button tabs at the top of the screen.

- Name
- Distance

3. Press the desired hotel or motel and press “Route To” to confirm the route.
4. Press the “GO” button to confirm the destination and begin the route.

If you are currently on a route guidance and you select a Hotel or Motel, the system asks you to choose one of the following:

- Cancel previous route
- Add to the Current Route

Within “Add to the Current Route” you can add the destination to your current route, or set it as your final destination.

**NOTE:** You can press the “back arrow” button on the touchscreen to return to the previous screen or the “X” button on the touchscreen to exit.

### POI — Gas Stations

To select a Gas Station POI, follow these steps:

1. While in the Nav Main Menu, press the “Where To?” button on the touchscreen, then press the “Point of Interest” button on the touchscreen.



2. Press the “Gas Stations” button on the touchscreen.



You can search for a gas station by the following categories, which are button tabs at the top of the screen.

- Name
  - Distance
3. Press the desired Gas Station and press “Route To” to confirm the route.
  4. Press “GO” to confirm destination and begin route.

If you are currently on a route guidance and you select a gas station, the system asks you to choose one of the following:

- Cancel previous route
- Add to Current Route

Within “Add to Current Route” you can add destination into your current route, or set the destination as your final destination.

**NOTE:** You can press the “back arrow” button on the touchscreen to return to the previous screen or the “X” button on the touchscreen to exit.

## POI — Shopping

To select a Shopping POI, follow these steps:

1. While in the Nav Main Menu, press the “Where To?” button on the touchscreen, then press the “Point of Interest” button on the touchscreen.



2. Press the “Shopping” button on the touchscreen.



You can search for shopping areas by the following categories, which are button tabs at the top of the screen.

- Name
  - Distance
3. Press the desired store and press “Route To” to confirm the route.
  4. Press the “GO” button to confirm the destination and begin route.

If you are currently on a route guidance and you select a store, the system asks you to choose one of the following:

- Cancel previous route
- Add to Current Route

Within “Add to Current Route” you can add destination into your current route, or set the destination as your final destination.

**NOTE:** You can press the “back arrow” button on the touchscreen to return to the previous screen or the “X” button on the touchscreen to exit.

## POI — ATM/Banking

To select a ATM or Bank POI, follow these steps:

1. While in the Nav Main Menu, press the “Where To?” button on the touchscreen, then press the “Point of Interest” button on the touchscreen.





2. Press the “ATM or Banking” button on the touchscreen.



You can search for an ATM or Bank by the following categories, which are button tabs at the top of the screen.

- Name
- Distance

3. Press the desired ATM or Bank and press “Route To” to confirm the route.

4. Press the “GO” button to confirm the destination and begin the route.

If you are currently on a route guidance and you select an ATM or Bank POI, the system asks you to choose one of the following:

- Cancel previous route
- Add to Current Route

Within “Add to Current Route” you can add the destination to the current route, or set it as the final destination.

**NOTE:** You can press the “back arrow” button on the touchscreen to return to the previous screen or the “X” button on the touchscreen to exit.

## Where To? — Trips

To route to a saved Trip, follow these steps:

1. While in the Nav Main Menu, press the “Where To?” button on the touchscreen then press the “Trips” button on the touchscreen.



2. Press the button on the touchscreen with the name of the desired Trip and press the first destination in the list.

3. Confirm the route by pressing “Route To,” and then press “GO” to confirm the destination and to start the route guidance.

To add a Trip, follow these steps:

1. Press the “Create New Trip” button on the touchscreen.
2. Press the “Destination” button on the touchscreen, and then press “Pick Destination.”
3. Press “Add Destination,” or “Insert Final Destination” to add waypoints and destinations to your trip.
4. Choose from the following options to add a destination
  - Address
  - Recent
  - Point of Interest
  - Favorites
  - Home
  - Intersection
  - GEO Coordinates
  - Point on Map
  - City Center
  - Closest Cities
  - Phone Number

**NOTE:** Refer to the individual section of the chosen option for further information.

5. To save your Trip, you must press “Calculate Route” and press “Save.”
6. Your new Trip appears on the Trips list.

To delete a Trip from the list, press the “Gear Icon” button on the touchscreen and then select “Delete” from the pop-up menu.

To display the options for a trip press the “Gear Icon” button on the touchscreen.

The following Options are available for each trip:

- Edit Name
- Move Up
- Move Down
- Delete

**NOTE:** You can press the “back arrow” button on the touchscreen to return to the previous screen or the “X” button on the touchscreen to exit.

## Where To? — Intersection

To enter a destination by Intersection, follow these steps:

1. While in the Nav Main Menu, press the “Where To?” button on the touchscreen, then press the “Intersection” button on the touchscreen.



2. Press the “City Name” or “Street Name” button, to enter the desired city, or street, name.

**NOTE:** If the system automatically recognizes the city, or street, it will populate a list of recognized cities, or streets, if not press the “List” button to select from the available options.

3. If “City Name” was selected, you must select the correct city, you will then be asked to spell the desired street name, and then the intersecting street.

If “Street Name” was selected, you must select the correct street, you will then be asked to spell the intersecting street, and then the desired city.

**NOTE:** If the system automatically recognizes the street, or city, it populates a list of recognized streets/cities, if not press the “List” button to select from the available options.

4. Press the “Route To” button on the touchscreen to confirm your route, and then press “GO” to confirm the destination and begin your route.

If you are currently on a route guidance and you select a Intersection, the system asks you to choose one of the following:

- Cancel previous route
- Add to Current Route

Within “Add to Current Route” you can add the destination to your current route, or set it as the final destination.

**NOTE:** You can press the “back arrow” button on the touchscreen to return to the previous screen or the “X” button on the touchscreen to exit.

### Where To? — Point on Map

To enter a destination by Point on Map, follow these steps:

1. While in the Nav Main Menu, press the “Where To?” button on the touchscreen then press the “Point on Map” button on the touchscreen.

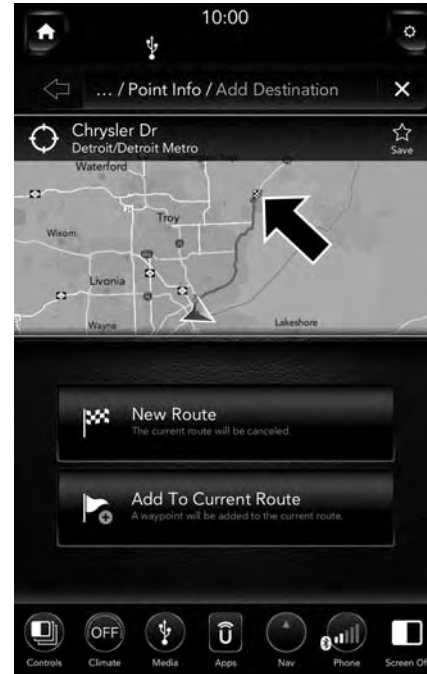

2. Use the touchscreen to drag the center of the cross over the desired destination.

3. Once your cross is where you want it, press “Route To”, or select “Places Nearby” to select a nearby destination. Then press “GO” to confirm the destination and begin route guidance.

If you are currently on a route guidance and you select a Point on Map, the system asks you to choose one of the following:

- Cancel previous route
- Add to Current Route

Within “Add to Current Route” you can add the destination to the current route, or set it as the final destination.

**NOTE:** You can press the “back arrow” button on the touchscreen to return to the previous screen or the “X” button on the touchscreen to exit.

### Where To? — Home

To enter your Home Address, follow these steps:

1. While in the Nav Main Menu, press the “Where To?” button on the touchscreen then press the “Home” button on the touchscreen.



If there is no Home Address entered, press “Yes” to enter it now.

- To set your Home Address choose one of the following options:

**NOTE:** Refer to the individual section of the chosen option for further information.

- City Name
- Street Name

Once you have generated your Home Address, you will be asked to Save it.

- Press the “Save Home” button on the touchscreen to confirm your destination and begin the route to your Home Address.
- This address will be saved as your Home Address and it can be accessed by pressing the “Home” button in the Where To? Menu.

**NOTE:** You can press the “back arrow” button on the touchscreen to return to the previous screen or the “X” button on the touchscreen to exit.

### Where To? — Work

To enter your Work Address, follow these steps:

- While in the Nav Main Menu, press the “Where To?” button on the touchscreen then press the “Work” button on the touchscreen.





If there is no Work Address entered, press “Yes” to enter it now.

- To set your Work Address, choose one of the following options:

**NOTE:** Refer to the individual section of the chosen option for further information.

- City Name
- Street Name

Once you have generated your Work Address, you will be asked to Save it.

- Press the “Save Work” button on the touchscreen to confirm your destination and begin the route to your Work Address.
- This address will be saved as your Work Address and it can be accessed by pressing the “Work” button in the Where To? Menu.

**NOTE:** You can press the “back arrow” button on the touchscreen to return to the previous screen or the “X” button on the touchscreen to exit.

## Where To? — City Center

To enter a destination by City Center, follow these steps:

- While in the Nav Main Menu, press the “Where To?” button on the touchscreen then press the “City Center” button on the touchscreen.



2. Enter the name of the City you would like to route to.
3. Press the desired city from the list.
4. Press the “Route To” button on the touchscreen to confirm your route, and then press “GO” to confirm your destination and begin your route.

If you are currently on a route guidance and you select a City Center, the system asks you to choose one of the following:

- Cancel previous route
- Add to Current Route

Within “Add to Current Route” you can add the destination to the current route, or set it as the final destination.

**NOTE:** You can press the “back arrow” button on the touchscreen to return to the previous screen or the “X” button on the touchscreen to exit.

### Where To? — Closest Cities

To enter a destination by Closest City, follow these steps:

1. While in the Nav Main Menu, press the “Where To?” button on the touchscreen then press the “Closest Cities” button on the touchscreen.



2. Press the desired city from the list.



3. Press the “Route To” button on the touchscreen to confirm your route and then press “GO” to confirm your destination and begin your route.

If you are currently on a route guidance and you select a Closest City, the system asks you to choose one of the following:

- Cancel previous route
- Add to Current Route

Within “Add to Current Route” you can add the destination to your current route, or set it as the final destination.

**NOTE:** You can press the “back arrow” button on the touchscreen to return to the previous screen or the “X” button on the touchscreen to exit.

## Where To? — Phone

To enter a destination by Phone number, follow these steps:

1. While in the Nav Main Menu, press the “Where To?” button on the touchscreen then press the “Phone Number” button on the touchscreen.



2. Enter the Phone Number of the destination you would like to route to.
3. Press the desired destination from the list.

4. Press the “Route To” button on the touchscreen to confirm your route, and then press “GO” to confirm your destination and begin your route.

If you are currently on a route guidance and you select a Phone number destination, the system asks you to choose one of the following:

- Cancel previous route
- Add to Current Route

Within “Add to Current Route” you can add the destination to your current route, or you can set it as your final destination.

**NOTE:** You can press the “back arrow” button on the touchscreen to return to the previous screen or the “X” button on the touchscreen to exit.

### Where To? — GEO Coordinate

To route to a saved Trip, follow these steps:

1. While in the Nav Main Menu, press the “Where To?” button on the touchscreen then press the “GEO Coordinate” button on the touchscreen.



2. Enter the Latitude by typing in the numbers. Use the dial pad to select specific numbers in the location shown.

3. Press the “OK” button on the touchscreen.
4. Enter the Longitude by typing in the numbers. Use the dial pad to select specific numbers in the location shown.
5. Press “OK” to confirm the destination.
6. Press the “Route To” button on the touchscreen to confirm your route, and then press “GO” to confirm your destination and begin your route.

If you are currently on a route guidance and you select a Geo Coordinate, the system asks you to choose one of the following:

- Cancel previous route
- Add to Current Route

Within “Add to Current Route” you can add the destination to your current route, or set it as your final destination.

**NOTE:** You can press the “back arrow” button on the touchscreen to return to the previous screen or the “X” button on the touchscreen to exit.

### **Where To? — Trails**

When starting to drive a trail you want to record, follow these steps:

1. While in the Nav Main Menu, press the “Where To?” button on the touchscreen then press the “Trails” button on the touchscreen.



2. Press “Start Recording.”
3. When you want to end the recording of a route, press the “Record” button, and press “Yes” to confirm.

The trip you record is added to the Recent Trails list.

### Before Route Guidance

Before confirming the destination with the “GO” button on the touchscreen, it is possible to select options different from the default route settings.

- Route Options – Press the “Route Options” button on the touchscreen to display a list of options to alter your route. To make a selection press and release the desired setting.



- Alternatives – Press the “Alternatives” button on the touch-screen to choose road types to avoid during your route. To make a selection press and release the desired setting.





## 128 NAVIGATION MODE — IF EQUIPPED

- Avoid – Press the "Avoid" button on the touchscreen to choose road types to avoid during your route. To make a selection press and release the desired setting.



- Since toll roads, tunnels and ferries are built for the purpose of shortening travel distances, avoiding these road types may increase distance and travel time.
- Save – Press the “Save” button on the touchscreen to save the destination as a Trip.

Press the “GO” button on the touchscreen to confirm your destination and to start your route guidance.

**NOTE:** You can press the “back arrow” button on the touchscreen to return to the previous screen or the “X” button on the touchscreen to exit.

## VIEW MAP

### View Map — Settings

With the Map displayed, press the button on the bottom right of the map that has three horizontal lines on it on the touchscreen. Then press the “Nav Settings” button on the touchscreen.



The following Map Settings are available:



- **Edit Route** — Press this button on the touchscreen to edit the route you select
- **Stop Guidance** — Press this button on the touchscreen to stop the previously selected guidance.
- **Upcoming Turns** — Press this button on the touchscreen to display upcoming turns on the route you select.
- **Repeat Guidance** — Press this button on the touchscreen to repeat the previously selected route.
- **Mute Guidance** — Press this button on the touchscreen to mute the guidance announcements.
  - U.S. (mile/feet)
  - Imperial (mile/yard)
  - Metric (meter)
- **GPS (DMS)** — Press this button on the touchscreen to change the GPS display. Press the desired button on the touchscreen.
  - Decimal
  - DMS
  - DM

**Copy device information to USB? — If Equipped** — Press this button on the touchscreen to copy your radio information to a USB jump drive through the available USB port.

## HOME

### Navigating Home

Refer to “Where To? — Home” in the “Where To?” section of this chapter for information.

## WORK

### Navigating To Work

Refer to “Where To? — Work” in the “Where To?” section of this chapter for information.

## INFORMATION

### Information — Main Menu

From the Nav Main Menu, press the “Information” button on the touchscreen and select one of the following options to view additional information.

- Traffic
- Where Am I?
- Trip Computer
- Country Info



### Information — SiriusXM Traffic Plus

To select SiriusXM Traffic Plus information, follow these steps:

1. While in the Nav Main Menu, press the “Information” button on the touchscreen.
2. Press the “Traffic” button on the touchscreen.



Traffic displays detailed traffic information, refer to SiriusXM Traffic Plus in this section for further information.

## Information — Where Am I?

To select “Where Am I?” information, follow these steps:

1. While in the Nav Main Menu, press the “Information” button on the touchscreen.
2. Press the “Where Am I?” button on the touchscreen.



Where Am I? displays the address and GEO Coordinates of your current location.

3. Press the “Show GPS Info” button on the touchscreen to view the GPS information.
4. Press the “Save” button on the touchscreen to save the location in your Favorites.

**NOTE:** You can press the “back arrow” button on the touchscreen to return to the previous screen or the “X” button on the touchscreen to exit.

### Information — Trip Computer

To select “Trip Computer” information, follow these steps:

1. While in the Nav Main Menu, press the “Information” button on the touchscreen.
2. Press the “Trip Computer” button on the touchscreen.



Trip Computer displays the following trip information from your last trip:

- Travel Direction
- Distance to final Destination
- Vehicle Speed
- Distance Traveled
- Overall average speed
- Moving average speed
- Maximum speed
- Total time traveled
- Travel time spent moving
- Travel time spent stopped

**NOTE:** You can press the “back arrow” button on the touchscreen to return to the previous screen or the “X” button on the touchscreen to exit.

### Information — Country Info

To select “Country Info” information, follow these steps:

1. While in the Nav Main Menu, press the “Information” button on the touchscreen.
2. Press the “Country Info” button on the touchscreen.



3. Select the desired country on the touchscreen. Information, such as average speed limits and specific phone number country codes, will be provided about the selected country.



## EMERGENCY

### Emergency — Main Menu

From the Nav Main Menu, press the “Emergency” button on the touchscreen and press one of the following options to search and route to a specific location.

- Hospital – Search and route to a Hospital close to your current location
- Police – Search and route to a Police Station close to your current location
- Fire Department – Search and route a Fire Department close to your current location



Press the “Where Am I?” button on the touchscreen to display your exact current location.

Press the “Save” button on the touchscreen to save your current location in Favorites.

**NOTE:** You can press the “back arrow” button on the touchscreen to return to the previous screen or the “X” button on the touchscreen to exit.

### Emergency — Hospital

To search for a Hospital close to your current location, follow these steps:

1. While in the Nav Main Menu, press the “Emergency” button on the touchscreen.
2. Press the “Hospital” button on the touchscreen.



You can search for a Hospital by the following categories, which are button tabs at the top of the screen.

- Name
- Distance

**NOTE:** In case of emergency, please contact the facility to verify their availability before proceeding.

3. Press the desired Hospital and press “Route To” to confirm your route, and then press “GO” to confirm the destination and begin route guidance.

If you are currently on a route guidance and you select a Hospital the system asks you to choose one of the following:

- Cancel previous route
- Add to Current Route

Within “Add to Current Route” you can add the destination to your current route, or set it as your final destination.

**NOTE:** You can press the “back arrow” button on the touchscreen to return to the previous screen or the “X” button on the touchscreen to exit.

### **Emergency — Police**

To search for a Police Station close to your current location, follow these steps:

1. While in the Nav Main Menu, press the “Emergency” button on the touchscreen.
2. Press the “Police” button on the touchscreen.



You can search for a Police Station by the following categories, which are button tabs at the top of the screen.

- Name
- Distance

**NOTE:** In case of emergency, please contact the facility to verify their availability before proceeding.

3. Press the desired Police Station and press "Route To" to confirm your route, and then press "GO" to confirm your destination and begin route guidance.

If you are currently on a route guidance and you select a Police Station the system asks you to choose one of the following:

- Cancel previous route
- Add to Current Route

Within "Add to Current Route" you can add the destination to your current route, or set it as your final destination.

**NOTE:** You can press the "back arrow" button on the touchscreen to return to the previous screen or the "X" button on the touchscreen to exit.

## Emergency — Fire Department

To search for a Fire Department close to your current location, follow these steps:

1. While in the Nav Main Menu, press the “Emergency” button on the touchscreen.
2. Press the “Fire Department” button on the touchscreen.



You can search for a Fire Department by the following categories, which are button tabs at the top of the screen.

- Name
- Distance

**NOTE:** In case of emergency, please contact the facility to verify their availability before proceeding.

3. Press the desired Fire Department and press “Route To” to confirm your route, and then press “GO” to confirm your destination and begin route guidance.

If you are currently on a route guidance and you select a Fire Department the system asks you to choose one of the following:

- Cancel previous route
- Add to Current Route

Within “Add to Current Route” you can add the destination to your current route, or set it as the final destination.

**NOTE:** You can press the “back arrow” button on the touchscreen to return to the previous screen or the “X” button on the touchscreen to exit.

## MAP UPDATES

The map data available in your vehicle is the most up-to-date information that was available when your vehicle was built. Map data is updated periodically as map information changes. Follow the steps below if you wish to obtain an update for your vehicle.

1. Please visit [chryslergroup.navigation.com](http://chryslergroup.navigation.com) to obtain your map update. At the top of the page, click the brand of your vehicle. Then, at the drop down menu, select your vehicle model and its model year. You will then be directed to a page that will let you know if your vehicle needs a map update or not.
2. Or, visit [DriveUconnect.com](http://DriveUconnect.com) (U.S. Residents) or [DriveUconnect.ca](http://DriveUconnect.ca) (Canadian Residents) and follow these steps:
  - Under the “Support” tab, click “Map Updates.” Select your vehicle brand, model, and year. Then, Simply follow the steps and place your order.

3. Or, if you wish, you can also visit your dealer or place a phone call to request your Map Update. FCA US LLC Dealer Garmin Support:

877-628-4480

FCA US LLC Consumer FreshMaps:

866-422-8171

US/CAN General Consumer Support:

888-628-6277

## SIRIUSXM TRAFFIC PLUS

**Don't drive through traffic. Drive around it.**

Avoid congestion before you reach it. By enhancing your vehicle's navigation system with the ability to see detailed traffic information, you can pinpoint traffic incidents, determine average traffic speed and estimate travel time along your route. Since the service is integrated with a vehicle's navigation system, SiriusXM Traffic Plus can help drivers pick the fastest route based on traffic conditions.

1. Detailed information on traffic speed, accidents, construction, and road closings.
2. Traffic information from multiple sources, including police and emergency services, cameras and road sensors.
3. Coast-to-coast delivery of traffic information.
4. View conditions for points along your route and beyond.

## SIRIUSXM TRAVEL LINK

In addition to delivering over 160 channels of the best sports, entertainment, talk, and commercial-free music, SiriusXM offers premium data services that work in conjunction with compatible navigation systems. SiriusXM Travel Link brings a wealth of useful information into your vehicle and right to your fingertips.

- Weather — Check variety of local and national weather information from radar maps to current and five day forecast.

- Fuel Prices — Check local gas and diesel prices in your area and route to the station of your choice.
- Sports Scores — In-game and final scores as well as weekly schedules.
- Movie Listings — Check local movie theatres and listings in your area and route to the theater of your choice.

SiriusXM Travel Link feature is completely integrated into your vehicle. A few minutes after you start your vehicle, Travel Link information arrives and updates in the background. You can access the information whenever you like, with no waiting.

- To access SiriusXM Travel Link, press the “Apps ” button on the touchscreen, then the SiriusXM Travel Link button on the touchscreen.

**NOTE:** SiriusXM Travel Link requires a subscription, sold separately after the trial subscription included with your vehicle purchase.





# VOICE RECOGNITION QUICK TIPS

## CONTENTS

---

■ INTRODUCING UCONNECT . . . . .	146	■ VEHICLE HEALTH REPORT/ALERT . . . . .	156
■ GET STARTED . . . . .	147	■ MOBILE APP . . . . .	156
■ BASIC VOICE COMMANDS . . . . .	148	■ SIRIUSXM TRAVEL LINK . . . . .	157
■ RADIO . . . . .	149	■ SIRI EYES FREE — IF EQUIPPED . . . . .	158
■ MEDIA . . . . .	150	■ USING DO NOT DISTURB . . . . .	159
■ PHONE . . . . .	151	■ ANDROID AUTO . . . . .	160
■ VOICE TEXT REPLY . . . . .	152	■ APPLE CARPLAY . . . . .	161
■ CLIMATE . . . . .	153	■ GENERAL INFORMATION . . . . .	162
■ NAVIGATION . . . . .	154	■ ADDITIONAL INFORMATION . . . . .	162
■ SIRIUSXM GUARDIAN — IF EQUIPPED . . . . .	155		
■ REGISTER . . . . .	156		

## INTRODUCING UCONNECT

Start using Uconnect Voice Recognition with these helpful quick tips. It provides the key Voice Commands and tips you need to know to control your Uconnect 4C NAV system.



## GET STARTED

All you need to control your Uconnect system with your voice are the buttons on your steering wheel.

1. Visit [UconnectPhone.com](http://UconnectPhone.com) to check mobile device and feature compatibility and to find phone pairing instructions.
2. Reduce background noise. Wind noise and passenger conversations are examples of noise that may impact recognition.
3. Speak clearly at a normal pace and volume while facing straight ahead. The microphone is located in the headliner and aimed at the driver.
4. Each time you give a Voice Command, you must first push either the VR or Phone button, wait until **after** the beep, then say your Voice Command.
5. You can interrupt the help message or system prompts by pushing the VR or Phone button and saying a Voice Command from current category.

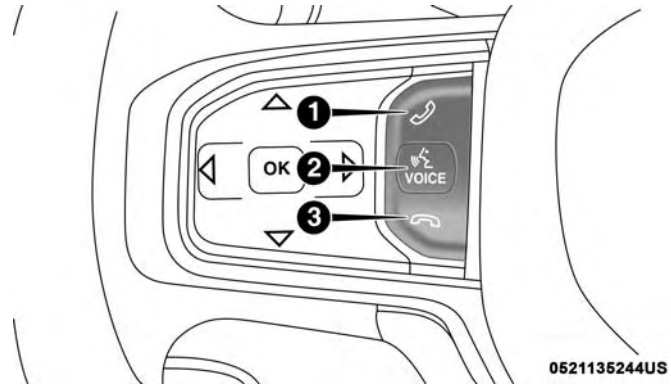

Uconnect Voice Command Buttons

- 1 — Push To Initiate Or To Answer A Phone Call, Send Or Receive A Text
- 2 — For All Radios: Push To Begin Radio, Climate, or Media Functions.
- 3 — Push To End Call

## BASIC VOICE COMMANDS

The basic Voice Commands below can be given at any point while using your Uconnect system.

Push the VR button . After the beep, say:

- “ **Cancel** ” to stop a current voice session
- “ **Help** ” to hear a list of suggested Voice Commands
- “ **Repeat** ” to listen to the system prompts again

Notice the visual cues that inform you of your voice recognition system’s status. Cues appear on the top of the touchscreen.



**NOTE:** Uconnect screen images are for illustration purposes only and may not reflect exact software for your vehicle.

## RADIO

Use your voice to quickly get to the AM, FM or SiriusXM Satellite Radio stations you would like to hear. (Subscription or included SiriusXM Satellite Radio trial required.)

Push the VR button . After the beep, say:

- “ **Tune to** ninety-five-point-five FM”
- “ **Tune to Satellite Channel Hits 1**”

**TIP:** At any time, if you are not sure of what to say or want to learn a Voice Command, push the VR button  and say “ **Help.**” The system provides you with a list of commands.



## MEDIA

Uconnect offers connections via USB, Bluetooth and auxiliary ports (If Equipped). Voice operation is only available for connected USB and AUX devices. (Remote CD player optional and not available on all vehicles.)

Push the VR button . After the beep, say one of the following commands and follow the prompts to switch your media source or choose an artist.

- “ Change source to Bluetooth”
- “ Change source to AUX”
- “ Change source to USB”
- “ Play artist Beethoven”; “ Play album Greatest Hits”; “ Play song Moonlight Sonata”; “ Play genre Classical”

**TIP:** Press the Browse button on the touchscreen to see all of the music on your USB device. Your Voice Command must match **exactly** how the artist, album, song and genre information is displayed.

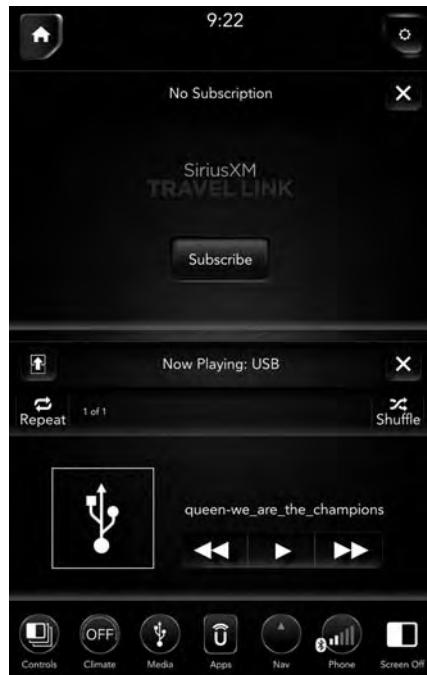

## PHONE

Making and answering hands-free phone calls is easy with Uconnect. When the Phonebook button is illuminated on your touchscreen, your system is ready. Check [UconnectPhone.com](http://UconnectPhone.com) for mobile phone compatibility and pairing instructions.

Push the Phone button . After the beep, say one of the following commands:

- “ Call John Smith”
- “ Dial 123-456-7890 and follow the system prompts”
- “ Redial (call previous outgoing phone number)”
- “ Call back (call previous incoming phone number)”

**TIP:** When providing a Voice Command, push the Phone button  and say “ Call,” then pronounce the name **exactly** as it appears in your phone book. When a contact has multiple phone numbers, you can say “ Call John Smith **work**.”





## VOICE TEXT REPLY

Uconnect announces **incoming** text messages. Push the Phone button  and say “**Listen.**” (Must have compatible mobile phone paired to Uconnect system.)

1. Once an incoming text message is read to you, push the Phone button . After the beep, say: “**Reply.**”
2. Listen to the Uconnect prompts. After the beep, repeat one of the pre-defined messages and follow the system prompts.

### PRE-DEFINED VOICE TEXT REPLY RESPONSES

Yes.	Stuck in traffic.	See you later.
No.	Start without me.	I'll be late.
Okay.	Where are you?	I will be <number> minutes late.
Call me.	Are you there yet?	
I'll call you later.	I need directions.	See you in <number> of minutes.
I'm on my way.	Can't talk right now.	
I'm lost.		Thanks.

**TIP:** Your mobile phone must have the full implementation of the **Message Access Profile (MAP)** to take advantage of this feature. For details about MAP, visit [UconnectPhone.com](http://UconnectPhone.com).

Apple iPhone iOS 6 or later supports reading **incoming** text messages only. To enable this feature on your Apple iPhone, follow these four simple steps:

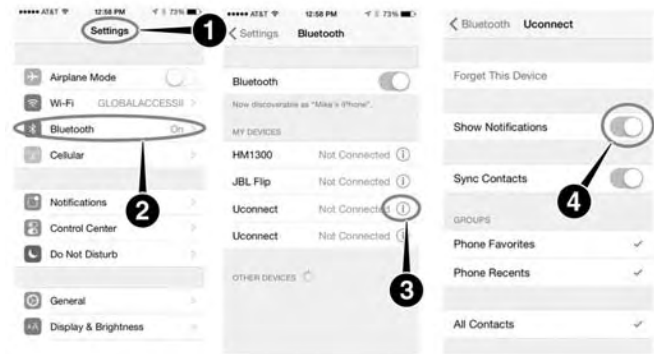

### iPhone Notification Settings

- 1 — Select “Settings”
- 2 — Select “Bluetooth”
- 3 — Select The (i) For The Paired Vehicle
- 4 — Turn On “Show Notifications”

**TIP:** Voice Text Reply is not compatible with iPhone, but if your vehicle is equipped with Siri Eyes Free, you can use your voice to send a text message.

## CLIMATE

Too hot? Too cold? Adjust vehicle temperatures hands-free and keep everyone comfortable while you keep moving ahead. (If vehicle is equipped with climate control.)

Push the VR button . After the beep, say one of the following commands:

- “ Set driver temperature to 70 degrees”
- “ Set passenger temperature to 70 degrees”

**TIP:** Voice Command for Climate may only be used to adjust the interior temperature of your vehicle. Voice Command will not work to adjust the heated seats or steering wheel if equipped.



## NAVIGATION

The Uconnect navigation feature helps you save time and become more productive when you know exactly how to get to where you want to go.

1. To enter a destination, push the VR button . After the beep, say, “ **Find address** 800 Chrysler Drive Auburn Hills, Michigan.”
2. Then follow the system prompts.

**TIP:** To start a POI search, push the VR button . After the beep, say: “ **Find nearest** coffee shop.”



**SIRIUSXM GUARDIAN — IF EQUIPPED****CAUTION!**

Some SiriusXM Guardian services, including SOS Call and Roadside Assistance Call will NOT work without an operable LTE (voice/data) or 3G or 4G (data) network connection compatible with your device.

**NOTE:** Your vehicle may be transmitting data as authorized by the subscriber.

An included trial and/or subscription is required to take advantage of the SiriusXM Guardian services in the next section of this guide. To register with SiriusXM Guardian, press the “Apps  ” button on the 12-inch touchscreen to get started.

**NOTE:** SiriusXM Guardian is available only on equipped vehicles purchased within the continental United States, Alaska and Hawaii. Services can only be used where coverage is available; see coverage map for details.

 SOS Call

 Theft Alarm Notification

 Remote Door Lock/Unlock

 Send & Go

 Vehicle Finder

 Stolen Vehicle Assistance

 Remote Vehicle Start\*\*

 Remote Horn & Lights

 Roadside Assistance Call

Vehicle Health Reports\*\*

Vehicle Health Alert\*\*

Performance Pages Plus\*\*

\*\*If vehicle is equipped.

## REGISTER

To unlock the full potential of SiriusXM Guardian in your vehicle, you must activate your SiriusXM Guardian services.

1. Press the “Apps ” icon on the bottom of your in-vehicle touchscreen.
2. Select the Activate Services icon from your list of apps.
3. Select “Customer Care” to speak with a SiriusXM Guardian Customer Care agent who will activate services in your vehicle, or select “Enter Email” to activate on the web.

## VEHICLE HEALTH REPORT/ALERT

Your vehicle will send you a monthly email report, which summarizes the performance of your vehicle’s key systems so you can stay on top of your vehicle’s maintenance needs. Your vehicle will also send you Vehicle Health Alerts when it detects issues with its key systems that need your attention. For further information go to the Owner Site website at [www.mopar.com/en-us/care/owners-manual.html](http://www.mopar.com/en-us/care/owners-manual.html)(U.S. Residents) or [www.mopar.ca](http://www.mopar.ca) (Canadian Residents).

## MOBILE APP

You’re only a few steps away from using remote commands and playing your favorite music in your car.



To use the Uconnect App:

- Download the Uconnect App to your mobile device.
- Press the Info button on the navigation bar at the bottom of the app for Vehicle Info.
- Press the Remote button on the navigation bar at the bottom of the app to Lock/Unlock, Remote Start, and activate your horn and lights remotely.

- Press the Location button on the navigation bar at the bottom of the app to bring up a map to locate your vehicle or send a location to your vehicle's navigation system.
- Press the Settings button in the upper left corner of the app to bring up app settings and access the Assist Call Centers.

**NOTE:** For further information please visit [DriveUconnect.com](http://DriveUconnect.com) (U.S. Residents) or [DriveUconnect.ca](http://DriveUconnect.ca) (Canadian Residents).

## SIRIUSXM TRAVEL LINK

Need to find a gas station, view local movie listings, check a sports score or the 5 - day weather forecast? SiriusXM Travel Link is a suite of services that brings a wealth of information right to your Uconnect 4C NAV system.

Push the VR button . After the beep, say one of the following commands:

- “ Show fuel prices”
- “ Show 5 - day weather forecast”
- “ Show extended weather”

**TIP:** Traffic alerts are not accessible with Voice Command.

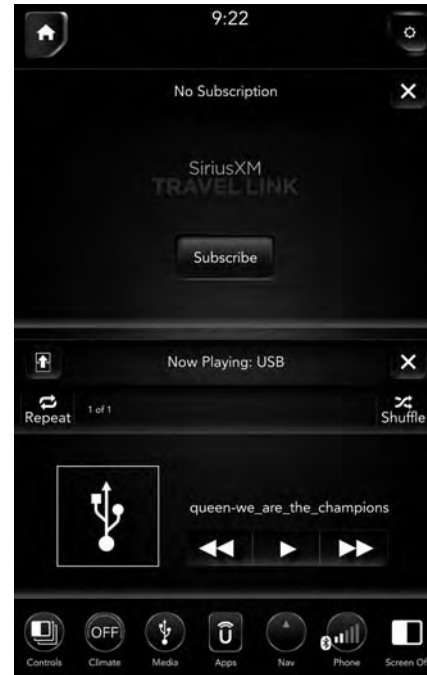

## SIRI EYES FREE — IF EQUIPPED

Siri lets you use your voice to send text messages, select media, place phone calls and much more. Siri uses your natural language to understand what you mean and responds back to confirm your requests. The system is designed to keep your eyes on the road and your hands on the wheel by letting Siri help you perform useful tasks.

To enable Siri, push and hold, then release the Uconnect Voice Recognition (VR) button on the steering wheel. After you hear a double beep you can ask Siri to play podcasts and music, get directions, read text messages and many other useful requests.



## USING DO NOT DISTURB

With Do Not Disturb, you can disable notifications from incoming calls and texts, allowing you to keep your eyes on the road and hands on the wheel. For your convenience, there is a counter display to keep track of your missed calls and text messages while you were using Do Not Disturb.

Do Not Disturb can automatically reply with a text message, a call or both, when declining an incoming call and send it to voicemail.

Automatic reply messages can be:

- “I am driving right now, I will get back to you shortly.”
- Create a custom auto reply message up to 160 characters.

While in Do Not Disturb, Conference Call can be selected so you can still place a second call without being interrupted by incoming calls.

### NOTE:

- Only the beginning of your custom message will be seen on the touchscreen.
- Reply with text message is not compatible with iPhones.
- Auto reply with text message is only available on phones that supporting Bluetooth MAP.



## ANDROID AUTO

Android Auto allows you to use your voice to interact with Android's best-in-class speech technology through your vehicle's voice recognition system, and use your smartphone's data plan to project your Android powered smartphone and a number of its apps onto your Uconnect touchscreen. Connect your Android 5.0 (Lollipop), or higher, to one of the media USB ports, using the factory-provided USB cable, and press the new Android Auto icon that replaces your "Phone" icon on the main menu bar to begin Android Auto. Push and hold the VR button on the steering wheel, or press and hold the "Microphone" icon within Android Auto, to activate Android's VR, which recognizes natural voice commands, to use a list of your smartphone's features:

- Maps
- Music
- Phone
- Text Messages
- Additional Apps



## APPLE CARPLAY

Apple CarPlay allows you to use your voice to interact with Siri through your vehicle's voice recognition system, and use your smartphone's data plan to project your iPhone and a number of its apps onto your Uconnect touchscreen. Connect your iPhone 5, or higher, to one of the media USB ports, using the factory-provided Lightning cable, and press the new CarPlay icon that replaces your "Phone" icon on the main menu bar to begin Apple CarPlay. Press and hold the VR button on the steering wheel, or press and hold the "Home" button within Apple CarPlay, to activate Siri, which recognizes natural voice commands to use a list of your iPhone's features:

- Phone
- Music
- Messages
- Maps
- Additional Apps



## GENERAL INFORMATION

The following regulatory statement applies to all Radio Frequency (RF) devices equipped in this vehicle:

This device complies with Part 15 of the FCC Rules and with Industry Canada license-exempt RSS standard(s). Operation is subject to the following two conditions

1. This device may not cause harmful interference, and
2. This device must accept any interference received, including interference that may cause undesired operation.

**NOTE:** Changes or modifications not expressly approved by the party responsible for compliance could void the user's authority to operate the equipment.

## ADDITIONAL INFORMATION

© 2018 FCA US LLC. All rights reserved. Mopar and Uconnect are registered trademarks and Mopar Owner Connect is a trademark of FCA US LLC. Android is a trademark of Google Inc. SiriusXM and all related marks and logos are trademarks of SiriusXM Radio Inc.

Uconnect System Support:

- U.S. residents visit [DriveUconnect.com](http://DriveUconnect.com) or call: 1-877-855-8400(24 hours a day 7 days a week)
- Canadian residents visit [DriveUconnect.ca](http://DriveUconnect.ca) or call: 1-800-465-2001(English) or 1-800-387-9983(French)

SiriusXM Guardian services support:

- U.S. residents visit [www.siriusxm.com/guardian](http://www.siriusxm.com/guardian) or call: 1-844-796-4827
- Canadian residents visit [www.siriusxm.ca/guardian](http://www.siriusxm.ca/guardian) or call: 1-877-324-9091

# UCONNECT + SIRIUSXM GUARDIAN

## CONTENTS

---

■ INTRODUCTION TO SIRIUSXM GUARDIAN . . .165	□ Send & Go . . . . .178
□ What Is SiriusXM Guardian? . . . . .165	□ Vehicle Finder . . . . .179
□ Included Trial Period For New Vehicles . . . . .167	□ 4G Wi-Fi Hotspot — If Equipped. . . . .181
□ Features And Packages . . . . .167	□ Theft Alarm Notification. . . . .183
■ GETTING STARTED WITH SIRIUSXM GUARDIAN. . . . .168	□ Stolen Vehicle Assistance. . . . .184
□ Activation . . . . .168	□ Remote Door Lock/Unlock . . . . .187
□ Download The Uconnect App . . . . .169	□ Remote Vehicle Start. . . . .190
□ Using Your Owner’s Site. . . . .170	□ Remote Horn & Lights . . . . .193
■ USING SIRIUSXM GUARDIAN . . . . .171	□ Monthly Vehicle Health Report . . . . .195
□ SOS Call . . . . .171	□ Vehicle Health Alert . . . . .195
□ Roadside Assistance Call. . . . .176	

- MANAGE MY SIRIUSXM GUARDIAN ACCOUNT . . . . .195
  - How To Manage My SiriusXM Guardian Account . . . . .195

- SIRIUSXM GUARDIAN AND FAQs . . . . .196
  - SiriusXM Guardian Business Hours: . . . . .196
  - Data Collection & Privacy . . . . .200
  - Safety Guidelines . . . . .201

## INTRODUCTION TO SIRIUSXM GUARDIAN

One of the many benefits of your vehicle's Uconnect system is that you can now take advantage of SiriusXM Guardian connected vehicle services. To unlock the full potential of SiriusXM Guardian in your vehicle, you first need to activate SiriusXM services.

### WARNING!

**ALWAYS** obey traffic laws and pay attention to the road. **ALWAYS** drive safely with your hands on the steering wheel. You have full responsibility and assume all risks related to the use of the features and applications in this vehicle. Only use the features and applications when it is safe to do so. Failure to do so may result in an accident involving serious injury or death.

**NOTE:** SiriusXM Guardian involves the collection, transmission and use of data from your vehicle. Refer to "Data Collection and Privacy" in "Uconnect + SiriusXM Guardian" for more information.

### What Is SiriusXM Guardian?

SiriusXM Guardian uses an embedded device in the Uconnect system installed in your vehicle, which receives GPS signals and communicates with the SiriusXM Guardian Customer Care center via wireless and landline communications networks. Depending on the type of device in your vehicle, some SiriusXM Guardian services require an operable LTE (voice/data) or 3G or 4G (data) network compatible with your device. SiriusXM Guardian is available only on equipped vehicles purchased within the continental United States, Alaska, Hawaii, Puerto Rico and Canada.

**NOTE:** Certain SiriusXM Guardian services are dependent on a properly installed and operational Uconnect device, cellular network availability that is compatible with the device in your vehicle, and GPS network availability. Not all features of SiriusXM Guardian are available everywhere at all times, particularly in remote or enclosed areas. Other factors outside the control of SiriusXM Guardian that may limit or prevent service delivery are hills, structures, buildings, tunnels, weather, damage to the electrical system or other important parts of your vehicle, network congestion, civil disturbances, actions of third parties or the government, Internet failure, or the physical location of your vehicle, such as in an underground parking structure or under a bridge.

For a complete list of available SiriusXM Guardian services, please visit: .

- U.S. residents: [siriusxm.com/guardian](http://siriusxm.com/guardian).
- Canadian residents: [siriusxm.ca/guardian](http://siriusxm.ca/guardian).

Not all SiriusXM Guardian features are available for all models.

SiriusXM Guardian provides:

- The ability to remotely lock/unlock your doors using the SiriusXM Guardian App, by calling SiriusXM Guardian Customer Care, or by logging on to your owner site at [www.mopar.com/en-us/care/owners-manual.html](http://www.mopar.com/en-us/care/owners-manual.html) (U.S. Residents) or [www.mopar.ca](http://www.mopar.ca) (Canadian Residents). You can also remotely start your vehicle (if equipped) from virtually anywhere and activate your horn and lights via the app or owner site.
- Theft Alarm Notification via text or e-mail.
- Send & Go capability with the SiriusXM Guardian App. Use the SiriusXM Guardian App to easily search, map and send your locations directly to your Uconnect Navigation.
- The ability to locate your vehicle, when you forget where you parked, using the Vehicle Finder function of the SiriusXM Guardian App.

Before you drive, familiarize yourself with the easy-to-use Uconnect System and SiriusXM Guardian services.

## The ASSIST and SOS Call Buttons On Your Rearview Mirror

The ASSIST Button is used for contacting Roadside Assistance, Vehicle Care, Uconnect Care, and SiriusXM Guardian Customer Care. The SOS Call button connects you directly to SiriusXM Guardian Customer Care for assistance in an emergency.

## Included Trial Period For New Vehicles

Your new vehicle may come with an included trial period for use of the SiriusXM Guardian services starting on the date of vehicle purchase. To get started with your trial, enrollment in SiriusXM Guardian is required. The Uconnect 4C NAV includes a trial\* of SiriusXM Guardian services from your date of purchase.

\* Included Trials apply to new vehicles only.

There are a few quick ways for you to identify your radio. For a more complete description, please refer to the User Guide in your glove box or visit [DriveUconnect.com](http://DriveUconnect.com) (U.S. Residents) or [DriveUconnect.ca](http://DriveUconnect.ca) (Canadian Residents).

- The Uconnect 4C NAV features a large 12-inch full color touchscreen.
- The Uconnect 4C NAV has Navigation. You will find the Nav icon on the bottom menu bar of the touchscreen, or listed under Uconnect Apps icon.

## Features And Packages

After the trial period, you must purchase a subscription to continue your services by visiting the SiriusXM Guardian Store or calling a SiriusXM Guardian Customer Care agent at:

- U.S. residents call: 1-844-796-4827
- Canadian residents call: 1-877-324-9091

SiriusXM has created a new feature to make subscribing for further services easier.



A message will pop-up on your touchscreen to subscribe and choose a package. Please see the below steps for subscribing to SiriusXM through the touchscreen:

1. Choose a package that works for you. It also allows you to compare other packages side by side in order to see the different features that SiriusXM offer.
2. Create an account by including your first name, address, city, state and email address.
3. Enter in your credit card and billing information.
4. Confirm your purchase and agree to their terms and conditions.

**NOTE:** There is also an option to view the details of your purchase, including the date your credit card will be charged, when your renewal date will be, and the estimated price of your renewal.

Clicking “Purchase” on your touchscreen will display a pop-up, reading “Your card is being processed.” At the Finish window, SiriusXM will ask you to create a password for the account. Once your password is approved, a message will appear on your touchscreen that displays, “Congratulations! You’re all set.” You will now be able to access SiriusXM, create personalized presets, and access the many other features that they offer.

For the latest information on packages and pricing information:

- U.S. residents visit [www.siriusxm.com/guardian](http://www.siriusxm.com/guardian)
- Canadian residents visit [www.siriusxm.ca/guardian](http://www.siriusxm.ca/guardian)

## GETTING STARTED WITH SIRIUSXM GUARDIAN

### Activation

To unlock the full potential of SiriusXM Guardian in your vehicle, you must activate your SiriusXM Guardian services.

1. Press the SiriusXM icon on the Media screen.
2. Select the Activate Services icon from your list of apps.
3. Select “Choose Package” to select a package and activate services in your vehicle. Follow the on-screen prompts to enter your information.

**NOTE:** A message will appear in your vehicle to advise when your SiriusXM trial period is about to expire and will offer the option to renew your subscription.

For further information, refer to “Features And Packages” in this section, or visit:

- U.S. residents visit: [siriusxm.com/guardian](http://siriusxm.com/guardian)
- Canadian residents visit: [siriusxm.ca/guardian](http://siriusxm.ca/guardian)

### Download The Uconnect App

Once you have activated your services, you’re only a few steps away from using remote commands.



Mobile App

To use the Uconnect app:

- Once you have activated your SiriusXM Guardian services, download the Uconnect app to your mobile device. Use your Owner Account login and password to open the app.
- Once on the “Remote” screen, you can begin using Remote Door Lock/Unlock, Remote Vehicle Start, and activate your horn and lights remotely, if equipped.
- Press the “Location” button on the bottom menu bar of the app to bring up a map to locate your vehicle or send a location to your Uconnect Navigation, if equipped.
- Press the “Settings” side menu in the upper left corner of the app to bring up app settings and access the Assist Call Centers.

**NOTE:** For further information:

- U.S. residents visit: [siriusxm.com/guardian](http://siriusxm.com/guardian)
- Canadian residents visit: [siriusxm.ca/guardian](http://siriusxm.ca/guardian)

## Using Your Owner's Site

Your Owner's Site website [www.mopar.com/en-us/care/owners-manual.html](http://www.mopar.com/en-us/care/owners-manual.html) (U.S. Residents), or [www.mopar.ca](http://www.mopar.ca) (Canadian Residents) provides you with all the information you need, all in one place. You can track your service history, find recommended accessories for your vehicle, watch videos about your vehicle's features, and easily access your user guides and manuals. It is also where you can manage your SiriusXM Guardian account. This section will familiarize you with the key elements of the website that will help you get the most of your SiriusXM Guardian system.

- **Edit Profile:**

To manage the details of your SiriusXM Guardian account, such as your contact information, password and SiriusXM Guardian PIN, click on the "Edit Profile" button to access the details of your account.

- **Connected Services Status:**

This statement will indicate your SiriusXM Guardian equipped vehicle.

- **Remote Commands:**

For vehicles with an active SiriusXM Guardian subscription, press one of these icons and enter your four-digit SiriusXM Guardian Security PIN to remotely start (if equipped), lock/unlock doors or sound the horn and lights.

## Editing Your Notifications

Notifications are an important element of your SiriusXM Guardian account. For example, any time you use your remote services (such as Remote Door Unlock), or if your security alarm is set off, you can elect to receive a text message, push notifications, and/or E-mail to notify you of the event. To set up the notifications, please follow these instructions.

1. Log on to your Owner's Account at [www.mopar.com/en-us/care/owners-manual.html](http://www.mopar.com/en-us/care/owners-manual.html) (U.S. Residents), or [www.mopar.ca](http://www.mopar.ca) (Canadian Residents).

2. Click the “Edit Profile” button.
3. Once there, you can edit Notification Preferences.
4. You can enter one mobile phone and/or E-mail address to notify you, and you can customize the types of messages.

## USING SIRIUSXM GUARDIAN

### SOS Call

#### CAUTION!

Some SiriusXM Guardian services, including SOS Call and Roadside Assistance Call will NOT work without an operable LTE (voice/data) or 3G or 4G (data) network connection compatible with your device.

### Access To Emergency Services At The Push Of A Button

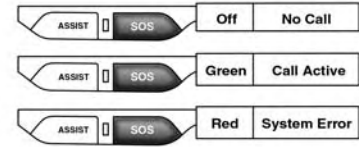
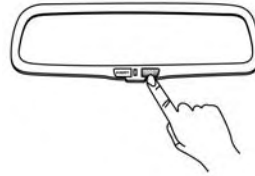

1101103021NA

### SiriusXM Guardian In-Vehicle Assistance Features

With SiriusXM Guardian, your vehicle has on-board assistance features located on the rear view mirror designed to enhance your driving experience if you should ever need assistance or support.

## Description

SOS Call is a feature that, at the push of a button, can contact emergency services. It's a convenient way to get in contact with a SiriusXM Guardian Customer Care agent in the event of an emergency. When the connection between the vehicle and the live agent is made, your vehicle will automatically transmit location information to SiriusXM Guardian Customer Care. In the event of a minor collision, medical or any other emergency, press the SOS button to be connected to a call center agent who can send emergency assistance to your vehicle's location.

**NOTE:** Certain SiriusXM Guardian services are dependent on a properly installed and operational Uconnect system, cellular network availability that is compatible with the device in your vehicle, and GPS network availability. Not all features of SiriusXM Guardian are available everywhere at all times, particularly in remote or enclosed areas.

## How It Works

1. Push the "SOS" Call button on the Rearview Mirror; the indicator light will turn green indicating a call has been placed.

## NOTE:

- In case the "SOS" Call button is accidentally pushed, there is a ten second delay before the SOS call is placed. The system will verbally alert you that a call is about to be made. To cancel the SOS Call connection, push the "SOS" Call button on the Rearview Mirror or press the "Cancel" button on the touchscreen within ten seconds.
  - During an SOS Call, the Bluetooth paired phone is disconnected so incoming or outgoing calls will go through mobile versus the handsfree system which is not available due to the SOS Call.
2. Once a connection between the vehicle and a SiriusXM Guardian Customer Care agent is made, the SOS Call system will connect your vehicle to a SiriusXM Guardian Customer Care agent who will stay on the line with you.

**NOTE:** Calls between the vehicle occupants and the SiriusXM Guardian Customer Care center may be recorded or monitored for quality assurance purposes. Through your enrollment in and use of the SiriusXM Guardian services, you consent to being recorded.

## SOS Call System Limitations

Vehicles that have been purchased in the U.S. and that travel into Mexico and Canada may have limited services. In particular, responses to SOS Call or other emergency services may be unavailable or very limited. Vehicles purchased outside the United States, and Canada are unable to receive SiriusXM Guardian services.

If the SOS Call system detects a malfunction, any of the following may occur at the time the malfunction is detected:

- The Rearview Mirror light will continuously be illuminated red.
- The screen will display the following message “Vehicle phone requires service. Please contact an authorized dealer.”
- An In-Vehicle Audio message will state “Vehicle phone requires service. Please contact an authorized dealer.”

Even if the SOS Call system is fully functional, factors beyond FCA US LLC’s control may prevent or stop SOS Call system operation. These include, but are not limited to, the following factors:

- The ignition key has been removed from the ignition and the delayed accessories mode is active.
- The ignition key is in OFF position.
- The vehicle’s electrical systems are not intact.
- The SOS Call system software and/or hardware is damaged during a vehicle crash.
- The vehicle battery loses power or becomes disconnected during a vehicle crash.
- LTE (voice/data) or 3G or 4G (data) coverage and/or Global Positioning Satellite signals are unavailable or obstructed.
- Network congestion.
- Weather.
- Buildings, structures, geographic terrain, or tunnels.

If your vehicle loses battery power for any reason (including during or after an accident) the SOS Call System, among other vehicle systems, will not operate.

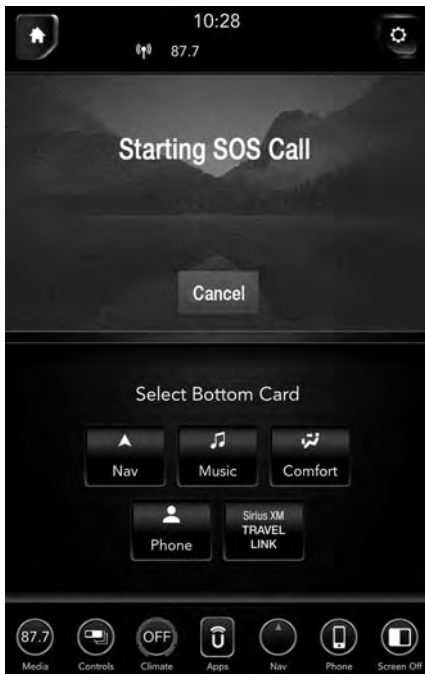

## Requirements

- This feature is available only on vehicles sold in the U.S.
- Vehicle must be properly equipped with the SiriusXM Guardian System. Vehicle must be registered with SiriusXM Guardian and have an active subscription that includes the applicable feature.
- Vehicle must have an operable LTE (voice/ data) or 3G or 4G (data) network connection compatible with your device.
- Vehicle must be powered in the ON/RUN or ACC (Accessory) position with a properly functioning electrical system.

## WARNING!

- Never place anything on or near the vehicle's LTE (voice/data) or 3G or 4G (data) and GPS antennas. You could prevent LTE (voice/data) or 4G (data) and GPS signal reception, which can prevent your vehicle from placing an emergency call.

*(Continued)*

**WARNING! (Continued)**

- Do not add any aftermarket electrical equipment to the vehicle's electrical system. This may prevent your vehicle from sending a signal to initiate an emergency call. To avoid interference that can cause the SOS Call system to fail, never add aftermarket equipment (e.g., two-way mobile radio, CB radio, data recorder, etc.) to your vehicle's electrical system or modify the antennas on your vehicle. **IF YOUR VEHICLE LOSES POWER FOR ANY REASON (INCLUDING DURING OR AFTER AN ACCIDENT), NEITHER THE UCONNECT APPS NOR THE SIRIUSXM GUARDIAN SERVICES WILL NOT OPERATE.**
- The Occupant Restraint Controller (ORC) turns on the Air Bag Warning Light on the instrument panel if a malfunction in any part of the air bag system is detected. If the Air Bag Warning Light is illuminated, the air bag system may not be working properly and the SOS Call system may not be able to send a signal to the SiriusXM Guardian Customer Care center. **If the Air Bag Warning Light is illuminated, have an authorized dealer service your vehicle immediately.**

*(Continued)***WARNING! (Continued)**

- Ignoring the Rearview Mirror light could mean you will not have SOS Call services if needed. If the Rearview Mirror light is illuminated, have an authorized dealer service the SOS Call system immediately.
- If anyone in the vehicle could be in danger (e.g., fire or smoke is visible, dangerous road conditions or location), do not wait for voice contact from a SiriusXM Guardian Customer Care agent. All occupants should exit the vehicle immediately and move to a safe location.
- Failure to perform scheduled maintenance and regularly inspect your vehicle may result in vehicle damage, accident or injury.



## FAQs

- 1. What Happens If I Accidentally Push The SOS Call Button On The Mirror?** You have 10 seconds after pushing the SOS Call button to cancel the call. To cancel the call, either push the "SOS" Call button again, or press the "cancel" button on the in-vehicle touchscreen.
- 2. What Type Of Information Is Sent When I Use The SOS Call Button From My Vehicle?** Certain vehicle information, such as make and model, is transmitted along with last known GPS location.

**NOTE:** Calls between vehicle occupants and the SiriusXM Guardian Customer Care center may be monitored or recorded for quality assurance. By using the service, you consent to the collection and sharing of this information.

### 3. When Could I Use The SOS Call Button?

You can use the SOS Call button to make a call if you or someone else needs emergency assistance.

## Roadside Assistance Call

Easy Call To Roadside Assistance 24/7 Using ASSIST Button

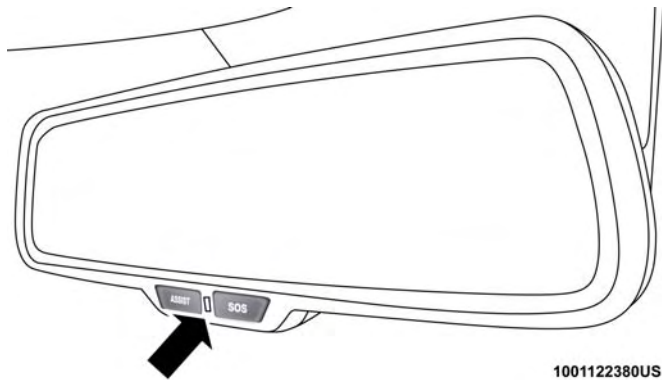

1001122380US

## SiriusXM Guardian In-Vehicle Assistance Features

With SiriusXM Guardian, your vehicle has on-board assistance features located on the rear view mirror designed to enhance your driving experience if you should ever need assistance or support.

## Description

Vehicles equipped with the SiriusXM Guardian system feature will contain an ASSIST button on the rear view mirror. Once your SiriusXM Guardian services have been activated, the ASSIST button can connect you directly to one of four important care centers for support.

- **Roadside Assistance Call** — If you get a flat tire, or need a tow, you'll be connected to someone who can help anytime. Additional fees may apply. (See the Disclaimers section below for more detail.)
- **SiriusXM Guardian Customer Care** — Contact the SiriusXM Guardian Customer Care call center to activate your services, renew after your trial has expired and for in-vehicle support for your SiriusXM Guardian system or help answering any general questions surrounding your connected services.
- **Uconnect Care Call** — In vehicle support for all non-connected Uconnect system features, such as radio and bluetooth connections.
- **Vehicle Care Call** — Total support for your vehicle.

## How It Works

You or someone in the vehicle simply presses the ASSIST button located on the rear view mirror and you will be presented with your ASSIST options on the touchscreen. Make your selection by pressing the touchscreen.

## Requirements

- This feature is available only on vehicles sold in the U.S.
- Vehicle must be properly equipped with the SiriusXM Guardian system.
- Vehicle must have an operable LTE (voice/data) or 3G or 4G (data) network connection.
- Vehicle must be registered with SiriusXM Guardian and have an active subscription that includes the applicable feature.
- Vehicle must be powered in the ON/RUN or ACC (Accessory) position with a properly functioning electrical system.

## Disclaimers

If Roadside Assistance Call is provided to your vehicle, you agree to be responsible for any additional roadside assistance service costs that you may incur. In order to provide SiriusXM Guardian services to you, we may record and monitor your conversations with Roadside Assistance Call, Vehicle Care, Uconnect Care, or SiriusXM Guardian Customer Care, whether such conversations are initiated through the SiriusXM Guardian services in your vehicle, or via a landline or mobile device, and may share information obtained through such recording and monitoring in accordance with regulatory requirements. You acknowledge, agree and consent to any recording, monitoring or sharing of information obtained through any such call recordings.

## FAQs

### What Is The Phone Number For Roadside Assistance Call?

The phone number is:

US:1-800-521-2779

Canada:1-800-363-4869

### If I Am Subscribed To SiriusXM Guardian, Does It Cover Towing Or Other Expenses Incurred By Using Roadside Assistance?

No, however your new vehicle may include Roadside Assistance Call services.

## Send & Go

Use the mobile app to easily search and send your locations directly to your vehicle navigation system. It's easy to enter and great for quick access on the go.

## Description

The Send & Go feature of the Uconnect App allows you to search for a destination on your mobile device, and then send the route to your vehicle's navigation system.

## How It Works

1. Use the SiriusXM Guardian App to find the destination.

There are multiple ways to find a destination. After selecting the "Location" tab at the bottom of the App, browse through one of the categories provided, or type the name or keyword in the search box at the top of the App. You can also select categories such as Favorites, Contact List.

2. Select your destination from the list that appears. Location information will then be displayed on the map.

From this screen, you will be able to:

- View the location on a map.
  - See the distance from your current location.
  - Send the address by selecting “Send to Vehicle” from the mobile app.
3. Send the destination to the Uconnect Navigation in your vehicle. You can also call the destination by pressing the “Call” button.
  4. Confirm your destination inside your vehicle by pressing the “Send To Vehicle” option on the pop-up that appears on the radio touchscreen.

### Requirements

- Vehicle must be properly equipped with the Uconnect system and a Uconnect 4C or Uconnect 4C NAV unit.
- Vehicle must have an operable LTE (voice/data) or 3G or 4G (data) network connection compatible with your device.
- Vehicle must be registered with SiriusXM Guardian and have an active subscription that includes the applicable feature.

### FAQs

1. **How long does it take to send the route and destination to my vehicle?** Depending on various conditions, it can take up to three minutes for the request to get through to your vehicle.
2. **Can I cancel a route I sent to my vehicle?** Yes, once you enter your vehicle, and start the engine, the pop-up message stating that you have a new route will appear. There is an exit button on the pop-up that will cancel to route if selected.
3. **Can I select a different route than the most recent one I sent to my vehicle?** Yes, once you enter the vehicle, and start the engine, the pop-message has a “Locations” option. Once “Locations” is selected you can choose from a list of recently sent destinations.

### Vehicle Finder

Forget where you parked your car? We'll help you locate it! Simply use the SiriusXM Guardian App on your smartphone and you'll be on track.

### Description

The Vehicle Finder feature of the Uconnect App allows you to find the location of your stationary vehicle when you

have lost it. You can also sound the horn and flash the lights to make finding your vehicle even easier.

### How It Works

Use the SiriusXM Guardian App to find the location of your vehicle.

1. Select the “Location” tab at the bottom of the App. Then touch the vehicle icon to find your vehicle.
2. Choose how you want to view the information by pressing the layers button. Three options will appear:
  - Map
  - Satellite
  - Hybrid
3. You can also select the “Person” icon to see your location.
4. Once the vehicle has been located, you can map a route to your vehicle.

### NOTE:

- You are responsible for using remote services that sound horn and flash lights in accordance with the laws, rules and ordinances in effect at the location of your vehicle.
- Certain SiriusXM Guardian services are dependent on a properly installed and operational Uconnect system, cellular network availability that is compatible with the device in your vehicle, and GPS network availability. Not all features of SiriusXM Guardian are available everywhere at all times, particularly in remote or enclosed areas.

### Requirements

- Vehicle Finder will not work while vehicle is in motion.
- Vehicle must be properly equipped with the Uconnect System.
- Vehicle must have an operable LTE (voice/data) or 3G or 4G (data) network connection compatible with your device.

- Vehicle must be registered with SiriusXM Guardian and have an active subscription that includes the applicable feature.
- Vehicle ignition must have been turned on within 14 days.

## FAQs

1. **Can someone else locate my vehicle?** Your vehicle may be located by anyone who has your PIN and access to your account. It is your responsibility to guard your PIN accordingly. See the Uconnect and SiriusXM Guardian terms of service for more information.
2. **How long does it take to sound my horn and flash the lights?** Depending on various conditions, it can take three minutes or more for the request to get through to your vehicle.
3. **How do I turn off the horn and lights after I turn them on?** If you are close enough to the vehicle, you can use the Key Fob to turn off the horn and lights by pressing the red "Panic" button.

## 4G Wi-Fi Hotspot — If Equipped



### WiFi Hotspot

#### Create A 4G Wi-Fi Hotspot For Use In Your Vehicle

#### Description

4G Wi-Fi Hotspot (If Equipped) is an in-vehicle service that connects your device to the AT&T LTE (voice/data) or 4G (data) network that is ready to go where ever you are. After you've made your purchase, turn on your device's Wi-Fi and connect your devices.

#### WARNING!

**The driver should NEVER use the 4G Wi-Fi Hotspot while driving the vehicle. Failure to do so may result in an accident involving serious injury or death.**

- Enables your passengers to connect up to eight mobile devices to the web.
- A high-speed, secure connection allows Wi-Fi-enabled devices – such as a laptop, tablet or smartphone to connect to your private in-vehicle network.

## How It Works

4G Wi-Fi Hotspot allows you and your passengers to connect their portable devices to the built-in 4G Wi-Fi capabilities of your Uconnect system. Purchasing 4G Wi-Fi Hotspot requires the use of an internet-enabled portable device. Uconnect offers a complimentary 3-month trial period that includes 1GB of total data. The trial can be activated any time within the first year of new vehicle ownership.

1. To start, make sure the box for Enable Wi-Fi Hotspot is un-checked.
2. Select the Wi-Fi Hotspot Setup option from the touchscreen to locate your Hotspot name and password. Take note of this information.
3. Tap the back arrow to return to the main Wi-Fi Hotspot page, then check the box to Enable Wi-Fi Hotspot.
4. From your portable device Wi-Fi settings menu, select the Hotspot name from the list of available networks and enter the password.
5. Open the web browser on your portable device and enter the following web address <https://myvehicle.att.com/#/login>.
6. Create a my vehicle account or log in to an existing account.
7. Select and purchase the desired subscription option. The Wi-Fi Hotspot activates after a few minutes. For additional assistance, call AT&T Customer Care at: 866-595-1330

Once the 4G Wi-Fi Hotspot is purchased you can change its name and the password by selecting the 4G Wi-Fi App and pressing the “Setup Wi-Fi Hotspot” button. You can also view the connected devices from the app screen by pressing the “View Connected Devices” button.

**NOTE:** A SiriusXM Guardian subscription is not required in order to purchase and use the 4G Wi-Fi Hotspot.

### **WARNING!**

**Always drive safely with your hands on the steering wheel and obey all applicable laws. You have full responsibility and assume all risks related to the use of the features and applications in this vehicle. Only use the features and applications in this vehicle when it is safe to do so. Failure to do so may result in an accident involving in serious injury or death.**

## Theft Alarm Notification

Notifies you via email, text message (SMS), or push notification when the vehicle's factory-installed theft alarm system has been triggered.

### Description

You've probably seen this before, a vehicle's alarm goes off in a parking lot or out on the street, and the owner is nowhere to be found. With Theft Alarm Notification, your vehicle will alert you of the situation.

### CAUTION!

**Should you receive a notification that your security alarm has been triggered, PLEASE RESPOND WITH CAUTION. There are a number of reasons why your alarm may have been triggered. In the event you believe your vehicle may have been stolen, please see the details of the Stolen Vehicle Assistance service below.**

## How It Works

Theft Alarm Notification can send you an email, text message (SMS), or push notification should the alarm go off. The following instructions will help you manage your notifications.

1. Log on to your Owner's Site website using the username and password you used when activating your SiriusXM Guardian system.
  - If you forgot your username or password, links are provided on the website to help you retrieve them.
2. Once logged in, click on the SiriusXM Guardian tab.
3. Once there, you can edit Notification Preferences.
4. If you have more than one vehicle with SiriusXM Guardian, use the drop-down menu to manage notifications on your preferred vehicle.
5. You can enter one mobile phone and/or E-mail address to your notifications, and you can customize the types of messages you receive.
6. You're all set. Should your theft alarm go off, a notification(s) will be sent to the number(s) and/or E-mail(s) you provided.



## Requirements

- Vehicle must be properly equipped with the SiriusXM Guardian System and a factory installed Theft Alarm system. **Vehicle must be registered with SiriusXM Guardian and have an active subscription that includes the applicable feature.**
- Your vehicle must have an operable LTE (voice/data) or 3G or 4G (data) network connection compatible with your device.
- Owner must properly set up notification to have the Theft Alarm Notification sent to an appropriate mobile device or E-mail account.

### CAUTION!

**In the event your theft alarm is activated, use caution and evaluate the situation from a safe distance. If any unauthorized or suspicious person is near or inside of your vehicle, immediately contact the police. Do not do anything that could jeopardize your safety or the safety of those around you.**

## FAQs

1. **How can I change where I receive notifications?** You can manage your notifications by going to your Owner's Site and log in with your username and password. Once there, you can click on "Edit Profile," then the Notification Preference.
2. **Can I receive a text message (SMS) when my Theft Alarm goes off?** Yes. You may choose where and how to receive notifications on the SiriusXM Guardian web portal.

## Stolen Vehicle Assistance

### Description

If your vehicle is stolen, the SiriusXM Guardian Customer Care agent may be able to locate the stolen vehicle and work with law enforcement to help recover it. You should contact local law enforcement immediately to file a stolen vehicle report. Once the report has been filed with law enforcement, you may notify SiriusXM Guardian Customer Care that you have filed the report. The SiriusXM Guardian Customer Care agent will ask for the stolen vehicle report number issued by local law enforcement. The vehicle must have an operable LTE (voice/ data) or 3G or 4G (data) network connection and must be registered

with SiriusXM Guardian with an active subscription that includes this feature. In addition, the vehicle must be within the United States.

### How It Works

1. If your vehicle is stolen, contact local law enforcement as soon as possible. They will work with you to file a stolen vehicle report.
  2. Next, inform SiriusXM Guardian Customer Care that your vehicle has been stolen. SiriusXM Guardian Customer Care can be reached by:
    - U.S. residents calling: 1-844-796-4827
    - Canadian residents calling: 1-877-324-9091
- The SiriusXM Guardian Customer Care Agent will ask for the stolen vehicle report number (as issued by your local law enforcement). If you have downloaded the SiriusXM Guardian App, you can push the “Settings” button on your device, select “ASSIST Call Centers,” and then select “SiriusXM Guardian Customer Care” to make the call.
3. SiriusXM Guardian Customer Care will authenticate that you are the owner of the vehicle and contact the law enforcement with whom you filed the stolen vehicle report.

4. SiriusXM Guardian Customer Care will work with your local law enforcement to locate the vehicle. You will be contacted by law enforcement if your vehicle is recovered. While the investigation is ongoing, you should also contact your insurance company to inform it of the situation.

### Requirements

- Vehicle must be properly equipped with the Uconnect System.
- Vehicle must have an operable LTE (voice/ data) or 3G or 4G (data) network connection compatible with your device.
- Vehicle must be registered with SiriusXM Guardian and have an active subscription that includes the applicable feature.

**NOTE:** Certain SiriusXM Guardian services are dependent on a properly installed and operational Uconnect system, cellular network availability that is compatible with the device in your vehicle, and GPS network availability. Not all features of SiriusXM Guardian are available everywhere at all times, particularly in remote or enclosed areas.

## FAQs

1. **What to do if my vehicle is stolen?** First, call local law enforcement as soon as possible. They will work with you to file a stolen vehicle report. Then SiriusXM Guardian Customer Care can be contacted by:

- U.S. residents calling: 1-844-796-4827
- Canadian residents calling: 1-877-324-9091

and inform SiriusXM Guardian Customer Care that your vehicle has been stolen and that you have filed a stolen vehicle report with law enforcement. SiriusXM Guardian Customer Care will help you through the process.

2. **Can someone locate my vehicle?** To enhance your privacy, and the privacy of others using your vehicle, a stolen vehicle police report is required for you to activate this service. You must involve local law enforcement to have SiriusXM Guardian locate your vehicle. We may also locate the vehicle for other law enforcement or government agencies, subject to a valid court order telling SiriusXM Guardian to do so. We will also provide the service for FCA entities to locate a vehicle that you have purchased through them.

3. **How will I know if my vehicle is recovered?** After you provide the SiriusXM Guardian Customer Care agent with the stolen vehicle report, the agent will work together with law enforcement to try to locate your vehicle. If your vehicle is recovered, you will be contacted by law enforcement.

4. **Can SiriusXM Guardian lower my insurance rates?** Some insurance providers offer lower rates on vehicles equipped with systems that can deter auto theft. When shopping for insurance, be sure to inform the insurance provider of your SiriusXM Guardian services subscription, to find out if the insurance provider can offer you a lower rate.

**NOTE:** Neither FCA nor SiriusXM are insurance companies, and SiriusXM Guardian is not an insurance product. You are responsible for obtaining insurance coverage for your vehicle and yourself.

## Remote Door Lock/Unlock

Lock Or Unlock Your Vehicle From Virtually Anywhere Using Your Computer, Mobile Device, Or SiriusXM Guardian Customer Care App.

### Description

The Remote Door Lock/Unlock feature provides you the ability to lock or unlock the door on your vehicle, without the keys and from virtually any distance. You can send a request to your vehicle in one of three ways:

- Using the Uconnect App from a compatible device
- From the your Owner's Site
- Contacting SiriusXM Guardian Customer Care

### How It Works

#### Uconnect App:

1. Download the Uconnect App to a compatible device and login using your username and password.
2. To lock the doors, push the button with the closed lock icon; to unlock the doors push the button with the open lock icon.

3. A pop-up screen will appear asking for your SiriusXM Guardian Security PIN (this is the same four digit code established when you activated your SiriusXM Guardian system). Enter the SiriusXM Guardian Security PIN on the keypad.
4. The Uconnect App will confirm if your command was sent (or not).
5. It will take a little while for the command to go through to your vehicle. The time it takes depends on a number of technical conditions.
6. A message will let you know if the command was received by your vehicle.

#### Your Owner's Site website:

1. Log on to your Owner's Site using the username and password you used when activating your SiriusXM Guardian system.

**NOTE:** If you forgot your username or password, links are provided on the website to help you retrieve them.

2. If you have more than one vehicle registered into your Owner's Site, select the vehicle you want to send the command by clicking on its image along the top.

3. Push the Door Lock icon next to your vehicle information.

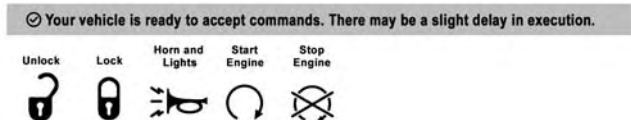

1001076627

4. You will then be asked to enter your SiriusXM Guardian Security PIN (this is the same four digit code established when you activated your SiriusXM Guardian system). Please enter your SiriusXM Guardian Security PIN.
5. A message will appear on the screen to let you know if the command has been sent to your vehicle.

### SiriusXM Guardian Customer Care:

1. If you need to unlock the doors of your vehicle, contact SiriusXM Guardian Customer Care by:
  - U.S. residents calling: 1-844-796-4827
  - Canadian residents calling: 1-877-324-9091
2. For security purposes, the SiriusXM Guardian Customer Care agent will verify your identity by asking for your 4-digit SiriusXM Guardian Security PIN.
3. After providing your SiriusXM Guardian Security PIN, you can ask them to lock or unlock your vehicle. The agent will send a command to your vehicle to get the task done.

**NOTE:** Anyone with access to your PIN may request Remote Door Lock/Unlock. It is your responsibility to protect your PIN appropriately.

## Requirements

- Vehicle must be properly equipped with the SiriusXM Guardian system.
- Vehicle must have an operable LTE (voice/data) or 3G or 4G (data) network connection. If using the Uconnect App to command your vehicle, your device must be compatible and be connected to an operable LTE (voice/data) or 3G or 4G (data) network connection.
- Vehicle must be registered with SiriusXM Guardian and have an active subscription that includes the applicable feature.
- An ignition cycle is required for some remote commands, such as Remote Vehicle Start and Remote Door Lock/ Unlock if following a Remote Horn & Lights activation.
- Your Remote Door Lock/Unlock request will not be processed if the vehicle is in motion, the ignition key is on or during an emergency call.

**NOTE:** The SiriusXM Guardian Care agents are trained to help you with unlocking of your door (for example, in an accidental lock-out). All other Remote Services should be performed via your Owner's Site or through the Uconnect App on your compatible device.

## FAQs

1. **How long does it take to unlock or lock the door?**  
Depending on various conditions, it can take up to 3 minutes or more for the request to get to your vehicle.
2. **Which is faster, my Key Fob or the Uconnect App?**  
Your Key Fob will lock/unlock the door more quickly, however its range is limited and your Uconnect App comes in handy for these and other situations.
3. **Will my vehicle be safe if I lose my device?** People sometimes lose their mobile devices, which is why security measures have been engineered into the Uconnect App. Asking for your username, password and SiriusXM Guardian Security PIN are required for the activation of Remote services through your mobile device. It is your responsibility to protect your passwords and PINs.

#### 4. Why can't all mobile devices use the Uconnect App?

The Uconnect App is compatible with most devices with the Apple and Android operating systems. The capabilities of these devices allows us to remotely command your vehicle. Other operating systems may be supported in the future.

#### 5. Why is the Uconnect App running slow?

The Uconnect App relies on a mobile network connection from your device to send commands to your vehicle which must have an operable LTE (voice/data) or 3G or 4G (data) network connection. If either your device or your vehicle are in an area with below average coverage, it may take longer to log in and send commands.

### Remote Vehicle Start

**Use Your Computer or Wireless Device App to Start the Engine And Remotely Warm Up or Cool Down the Vehicle**

#### Description

The Remote Vehicle Start feature provides you with the ability to start the engine on your vehicle, without the keys and from virtually any distance. Once started, the preset climate controls in your vehicle can warm up or cool down

the interior before you have to get in. You can send a request to your vehicle in one of two ways:

- Using the Uconnect App from a compatible device.
- From the Your Owner Site website.

You can also send a command to turn off an engine that has been started using Remote Vehicle Start. After 15 minutes if you have not entered your vehicle with the key, the engine will shut off automatically.

This remote function requires your vehicle to be equipped with a factory-installed Remote Start system.

If you want, you can set up notifications for your account push notifications every time a command is sent to Remote Start or cancel a Remote Start.

#### How It Works

#### SiriusXM Guardian For Uconnect App:

1. Download the Uconnect App to a compatible device and login using your username and password.
2. To start the engine, press the "circular arrow." To turn off an engine that has been remote started, press the circular arrow with an X in the middle button.

3. A pop-up screen will appear asking for your SiriusXM Guardian Security PIN (this is the same 4-digit code established when you registered your SiriusXM Guardian system). Enter the SiriusXM Guardian Security PIN on the keypad.
  4. The Uconnect App will confirm if your command was sent (or not).
  5. It will take a little while for the command to go through to your vehicle. The time it takes depends on a number of technical conditions.
  6. A message will let you know if the command was received by your vehicle.
2. If you have more than one vehicle registered into your Owner's Site, select the vehicle you want to send the command by clicking on its image along the top.
  3. Beneath the image of a vehicle like yours, you will see a row of icons. On your dashboard you will see remote command icons. To start the engine, press the "circular arrow," to turn-off an engine that has been remote started press the "cancel" button.
  4. You will then be asked to enter your SiriusXM Guardian Security PIN (this is the same 4-digit code established when you activated your SiriusXM Guardian system). Please enter your SiriusXM Guardian Security PIN.
  5. A message will appear on the screen to let you know if the command was received by your vehicle.

#### Your Owner Site website:

1. Log on to your Owner Site using the username and password you used when activating your SiriusXM Guardian services in your vehicle.

**NOTE:** If you forgot your username or password, links are provided on the website to help you retrieve them.

**NOTE:** The SiriusXM Guardian Customer Care agents are not trained for Remote Vehicle Start services.



## FAQs

**1. How long does it take to remotely start my vehicle?**

Depending on various conditions, it can take three minutes or more for the request to get through to your vehicle.

**2. Which is faster, my Key Fob or the Uconnect App?**

Your Key Fob will remote start your vehicle more quickly. However its range is limited. For example, when you are leaving the stadium after the game, you can use the Uconnect App to remote start your vehicle and have the inside of your vehicle comfortable by the time you get to it.

**3. Will my vehicle be safe if I lose my wireless device?**

People sometimes lose their wireless devices, which is why security measures have been engineered into the Uconnect App. Asking for your username, password and SiriusXM Guardian Security PIN help to ensure that nobody can start your vehicle if they happen to find your device.

**4. Can someone drive off with my vehicle using the App?**

No. Driving your vehicle still requires the keys to be in the vehicle. The Remote Start feature simply starts the engine to warm up or cool down the interior before you arrive.

**5. Can I stop a vehicle that is being driven with the cancel Remote Vehicle Start command?**

No. If the vehicle is in motion, the cancel Remote Vehicle Start button will not stop the vehicle.

**6. Why can't all mobile devices use the Uconnect App?**

The Uconnect App has been designed to work on most devices with the Apple and Android operating systems. The capabilities of these device allows us to remotely command your vehicle. Other operating systems may be supported in the future.

## Remote Horn & Lights

### Can't Find Your Vehicle In The Parking Lot? Sound The Horn And Flash The Lights On Your Vehicle To Locate It

#### Description

It is easy to locate a vehicle in a dark, crowded or noisy parking area by activating the horn and lights. It may also help if you need to draw attention to your vehicle for any reason. You can send a request to your vehicle in one of two ways:

- Using the Uconnect App from a compatible device.
- From your Owner's Site website.

If you want, you can set up, push notifications every time a command is sent to turn on the horn and lights.

#### Uconnect App:

#### How It Works

1. Download the Uconnect App to a compatible device and login using your username and password.
2. To turn on the horn and lights, press the "trumpet icon."
3. A pop-up screen will appear asking for your SiriusXM Guardian Security PIN (this is the same four digit code established when you activated your SiriusXM Guardian system). Enter the SiriusXM Guardian Security PIN on the keypad.
4. The Uconnect App will confirm if your command was sent (or not).
5. It will take a little while for the command to go through to your vehicle. The time it takes depends on a number of technical conditions.
6. A message will let you know if the command was received by your vehicle.

#### Your Owner Site website:

1. Log on to your Owner's Site website using the username and password you used when registering your SiriusXM Guardian system.
  - If you forgot your username or password, links are provided on the website to help you retrieve them.
2. If you have more than one vehicle registered into your Owner's Site, select the vehicle you want to send the command by clicking on its image along the top.

3. Beneath the image of a vehicle like yours, you will see a row of icons. To turn on the horn and lights, press the “trumpet icon.” To turn off the horn and lights, press the “trumpet icon” again.

**NOTE:** A quicker way to turn off your Remote Horn & Lights would be to push the “Panic” button on your Key Fob if you are near the vehicle.

4. You will then be asked to enter your SiriusXM Guardian Security PIN (this is the same four digit code established when you activated your SiriusXM Guardian system). Please enter your SiriusXM Guardian Security PIN.
5. A message will appear on the screen to let you know if the command was received by your vehicle.

**NOTE:** The Remote Horn & Lights feature is designed to be loud and get noticed. Please keep in mind the surroundings when using this feature. You are responsible for compliance with local laws, rules and ordinances in the location of your vehicle when using Remote Horn & Lights.

## FAQs

1. **How long does it take to sound my horn and flash the lights?** Depending on various conditions, it can take three minutes or more for the request to get through to your vehicle.
2. **Which is faster, my Key Fob or the Uconnect App?** Your Key Fob will sound the horn and flash the lights quicker; however its range is limited.
3. **How do I turn off the horn and lights after I turn them on?** If you are close enough to the vehicle, you can use the Key Fob to turn off the horn and lights by pressing the red “Panic” button. Otherwise, Remote Horn & Lights will continue for 20 seconds.
4. **Why can't all mobile devices use the Uconnect App?** The Uconnect App has been designed to work on most devices with the Apple and Android operating systems. The capabilities of these device allows us to remotely command your vehicle. Other operating systems may be supported in the future.

## Monthly Vehicle Health Report

Monthly Vehicle Health Report is a Uconnect service through which a summary of the performance of your vehicle's key systems will be sent to you every month so you can stay on top of your vehicle's maintenance needs. This is provided as a convenience to you and does not substitute for your regular maintenance to your vehicle.

In order to provide the monthly Vehicle Health Report, the Uconnect System in your vehicle may collect and transmit vehicle data to SiriusXM Guardian and to FCA, such as your vehicle's health and performance, your vehicle's location, your utilization of the features in your vehicle, and other data.

This data collection and transmission begins when you enroll in SiriusXM Guardian and will continue even if you cancel your SiriusXM Guardian subscription unless and until you call SiriusXM Guardian Customer Care and tell us to deactivate your Uconnect system at:

- U.S. residents call: 1-844-796-4827
- Canadian residents call: 1-877-324-9091

Please see the Uconnect Privacy Policy for more information, located at [www.driveuconnect.com/sirius-xm-guardian/privacy.html](http://www.driveuconnect.com/sirius-xm-guardian/privacy.html) (U.S. Residents) or [www.driveuconnect.ca](http://www.driveuconnect.ca) (Canadian Residents).

## Vehicle Health Alert

Your vehicle will send you an email alert if it senses a problem under the hood with one of your vehicle's key systems. For further information, go to your Owner's Site website.

**NOTE:** Vehicle Health Alert emails require you to register, and activate services. During this process you will be asked to provide an email address to which the reports will be sent.

## MANAGE MY SIRIUSXM GUARDIAN ACCOUNT

8

### How To Manage My SiriusXM Guardian Account

To manage your SiriusXM Guardian account, press the ASSIST button in your vehicle, or call SiriusXM Guardian Customer Care.

**NOTE:** It is recommended, when selling your vehicle, or turning in your lease, to call SiriusXM Guardian Care to remove your personal data.

For further assistance call SiriusXM Guardian Customer Care:

- U.S. residents call: 1-844-796-4827
- Canadian residents call: 1-877-324-9091

### SIRIUSXM GUARDIAN AND FAQs

For additional information about SiriusXM Guardian if you have an active subscription, push the ASSIST button on the rear view mirror and then select SiriusXM Guardian Call on your in-vehicle touchscreen to contact SiriusXM Guardian. Your call will be directed to a SiriusXM Guardian agent or held in a queue until an agent is available or go to your Owner's Site website. If you do not have an active subscription, push the ASSIST button and click the Activate button to activate services.

You can also phone SiriusXM Guardian directly by:

- U.S. residents calling: 1-844-796-4827
- Canadian residents calling: 1-877-324-9091

### SiriusXM Guardian Business Hours:

Central Time

- Monday through Friday – 7:00 am to 10:00 pm
- Saturday – 8:00 am to 9:00 pm

1. **How Do I Register For My SiriusXM Guardian Account?** Push the ASSIST button on your rearview mirror. Press the “Activate” button on the touchscreen. Select “Call Care” to speak with a SiriusXM Guardian Customer Care agent or select “Enter Email” to activate on the web. If you choose to enter your email address, you will then confirm your email address. You will receive an email with an activation link that will be good for 72 hours. Once you click the activation link, you will be prompted to fill out your information and accept Terms and Conditions. Then, you will be directed to the SiriusXM Guardian home page to complete your profile and demo the remote services.
2. **Why Do I Need An Email Address?** Without an email address, customers cannot register for SiriusXM Guardian. Customers need to register so they can subscribe to receive additional services and create a SiriusXM Guardian Security PIN for remote command requests.

3. **How Do I Create A SiriusXM Guardian Security PIN?**  
Set up your SiriusXM Guardian Security PIN during the registration process. The SiriusXM Guardian Security PIN will be required to authenticate you when accessing your account via SiriusXM Guardian Call or performing any remote services, such as Remote Door Lock/Unlock, Remote Horn & Lights, or Remote Vehicle Start.
4. **What If I Forgot My SiriusXM Guardian Security PIN?**  
If you've already activated services, and forgot your SiriusXM Guardian Security PIN, you can reset the PIN by selecting Edit Profile on your Owner Site.  
You can also call SiriusXM Guardian Customer Care:
  - U.S. residents call: 1-844-796-4827
  - Canadian residents call: 1-877-324-9091
5. **How Do I Update My SiriusXM Guardian Payment Account Address?** Your SiriusXM Guardian Payment Account address can be updated online, or by calling SiriusXM Guardian Customer Care from ASSIST in your vehicle. To update online: Login to your Owner's Site, and select Edit Profile > SiriusXM Guardian Payment Account.
6. **How Do I Update My SiriusXM Guardian Profile?**  
Your name, home address, phone number, email address and SiriusXM Guardian Security PIN can be updated online on your Owner's Site. Log in to your Owner's Site then select Edit Profile to edit your personal information. Make your edits and click "Save."
7. **Can I Try Features Or Packages Before I Buy Them?**  
Your new vehicle purchase may have come with an included trial period for certain Apps and services. For more information, please contact SiriusXM Guardian:
  - U.S. residents call: 1-844-796-4827
  - Canadian residents call: 1-877-324-9091
8. **Can I Access Every App And Service While Driving?**  
No, some applications and services are not available while driving. For your own safety, it is not possible to use some of the touchscreen features while the vehicle is in motion (e.g. key pad).

9. **What Happens When My Subscription Comes Up For Renewal?** If you have added a credit card to your account information, your subscription will be automatically renewed for a term length in accordance with the service plan that you have selected at the then current subscription rate and on every renewal date thereafter, unless you cancel your subscription by calling SiriusXM Guardian Care. If you have not added a credit card to your account, SiriusXM Guardian will send you an email or letter in advance of your expiration date to remind you that your subscription is ending soon.
10. **How Do I Manage My SiriusXM Guardian Notification Preferences?** Contact SiriusXM Guardian Customer Care, or go to your Owner's Site and then update your preferences on the SiriusXM Guardian customer web portal.
11. **How Do I Purchase A Subscription?** Contact SiriusXM Guardian Customer Care by pushing the ASSIST button on your rearview mirror.

12. **How Do I Update My Credit Card Information?** Login to your Owner's Site, and select Edit Profile, then select SiriusXM Guardian Payment Account, or call SiriusXM Guardian Customer Care:

- U.S. residents call: 1-844-796-4827
- Canadian residents call: 1-877-324-9091

13. **How Do I Find Out How Much Longer I Have On My Subscription?** Contact SiriusXM Guardian Customer Care at:

- U.S. residents call: 1-844-796-4827
- Canadian residents call: 1-877-324-9091

or visit your Owner's Site and choose a subscription to view its expiration date. When your subscription is about to expire, you will receive an email or letter notification.

14. **Can I Get A Refund If I Have Not Used The Entire Subscription?** Pro-rata refunds are provided from the date of cancellation for annual plans or longer. Please see the Uconnect and SiriusXM Guardian Terms & Conditions for refunds related to billing plans of other lengths and other circumstances. Or, for more information, call SiriusXM Guardian Customer Care at:

- U.S. residents call: 1-844-796-4827
- Canadian residents call: 1-877-324-9091

15. **Can I Cancel A Subscription Before It Expires?** Yes. If you have an annual subscription, your subscription will be cancelled the day you cancel. If you have a monthly subscription, your subscription will be cancelled on the last day of the month in which you chose to cancel. For other subscriptions, please call SiriusXM Guardian Customer Care at:
- U.S. residents call: 1-844-796-4827
  - Canadian residents call: 1-877-324-9091
16. **What Should I Do If I Want To Sell My Vehicle?** Before your vehicle is sold to a new owner, you'll want to remove your account information. This process removes all personal information and returns the Uconnect system to its original factory settings and removes all SiriusXM Guardian services and account information. To remove your account information from the Uconnect system, contact SiriusXM Guardian Customer Care at:
- U.S. residents call: 1-844-796-4827
  - Canadian residents call: 1-877-324-9091
17. **What If I Forgot To Remove My Account Information Before I Returned My Lease Vehicle Or Sold It?** Contact SiriusXM Guardian Customer Care:
- U.S. residents call: 1-844-796-4827
  - Canadian residents call: 1-877-324-9091
18. **What will happen if an operable LTE (voice/data) or 4G (data) network connection compatible with my device is temporarily unavailable?** The SOS Call and ASSIST buttons will NOT function if you are not connected to an operable LTE (voice/data) or 3G or 4G (data) network. Services that required your smartphone only direct calls to Roadside Assistance Call may be functioning if you have an operable network.



## Data Collection & Privacy

The Uconnect System collects and transmits data which may include information about your vehicle, your vehicle's health and performance, your vehicle's location, your utilization of the features in your vehicle, and other data. The collection, use and sharing of this information is required to provide the SiriusXM Guardian services and is further described by the Uconnect Privacy Policy, which can be found at [www.driveuconnect.com/sirius-xm-guardian/privacy.html](http://www.driveuconnect.com/sirius-xm-guardian/privacy.html) (U.S. Residents) or [www.driveuconnect.ca](http://www.driveuconnect.ca) (Canadian Residents). This information may be collected by SiriusXM Connected Vehicle Services Inc. and shared with FCA US LLC for the purposes stated in the Uconnect Privacy Policy. Vehicle health and diagnostic information including location data may be used by Uconnect to provide a Vehicle Health Report to you.

**Even if you cancel your SiriusXM Guardian subscription, this vehicle diagnostic health information, including location data, may still be transmitted from your vehicle and you may still have a Vehicle Health Report sent to you.**

Use of any of the Uconnect Services including SiriusXM Guardian is deemed to be your consent to the collection, use and disclosure of this information in accordance with the Uconnect Privacy Policy. If you do not want this information to be collected, used, or shared, you must cancel your Uconnect services in their entirety by contacting us as referenced in the Uconnect Privacy Policy.

## Safety Guidelines

### WARNING!

**ALWAYS** obey traffic laws and pay attention to the road. **ALWAYS** drive safely with your hands on the steering wheel. You have full responsibility and assume all risks related to the use of the features and applications in this vehicle. Only use the features and applications when it is safe to do so. Failure to do so may result in an accident involving serious injury or death.

Ensure that all persons read this manual carefully before using the radio system. It contains instructions on how to use the system in a safe and effective manner.

- Glance at the screen only when safe to do so. If prolonged viewing of the screen is required, park in a safe location and set the parking brake.
- Stop use of the system immediately if a problem occurs. Failure to do so may cause injury or damage to the product. Return it to your authorized dealer to repair.
- Ensure the volume level of the system is set to a level that still allows you to hear outside traffic and emergency vehicles.



19UC4CN12-526-AB

Second Edition Rev 1

Uconnect 4C NAV with 12-inch Display

Printed in the USA



©2018 FCA US LLC. All Rights Reserved.

Chrysler, Dodge, Jeep, Ram, Mopar and Uconnect are trademarks of FCA US LLC.

FIAT is a registered trademark of FCA Group Marketing S.p.A.,

used under license by FCA US LLC.