

<b>Quick guide</b>	<ul style="list-style-type: none"> <li>• Basic system overview</li> <li>• Giving guidance for the route quickly</li> </ul>	<b>1</b>
<b>Basic function</b>	<ul style="list-style-type: none"> <li>• Information to be read before operation</li> <li>• Setting initial settings before operation</li> <li>• Connecting the Bluetooth® device</li> </ul>	<b>2</b>
<b>Navigation system</b>	<ul style="list-style-type: none"> <li>• Operating the map screen</li> <li>• Searching the map</li> <li>• Activating the route guidance</li> </ul>	<b>3</b>
<b>Audio/visual system</b>	<ul style="list-style-type: none"> <li>• Listening to the radio</li> <li>• Enjoying music and video</li> </ul>	<b>4</b>
<b>Voice command system</b>	<ul style="list-style-type: none"> <li>• Operating the voice command system</li> </ul>	<b>5</b>
<b>Information</b>	<ul style="list-style-type: none"> <li>• Operating the weather information screen</li> </ul>	<b>6</b>
<b>Peripheral monitoring system</b>	<ul style="list-style-type: none"> <li>• Checking the situation around the vehicle</li> </ul>	<b>7</b>
<b>Phone</b>	<ul style="list-style-type: none"> <li>• Operating the phone (Hands-free system for cellular phones)</li> </ul>	<b>8</b>
<b>Connected services</b>	<ul style="list-style-type: none"> <li>• Operating connected services</li> </ul>	<b>9</b>
<b>Index</b>	<ul style="list-style-type: none"> <li>• Search alphabetically</li> </ul>	

Introduction ..... **6**  
Reading this manual ..... **8**

**1**      **Quick guide**

**1-1. Basic function**  
Buttons overview ..... **12**  
“Menu” screen ..... **14**  
Status icon ..... **16**  
“Setup” screen ..... **18**  
“Information” screen ..... **19**

**1-2. Navigation operation**  
Operating the map screen **21**  
Guiding the route ..... **22**  
Registering home ..... **23**

**2**      **Basic function**

**2-1. Basic information before operation**  
Initial screen ..... **26**  
Touch screen ..... **27**  
Home screen ..... **29**  
Entering letters and numbers/list screen operation **30**  
Screen adjustment ..... **33**  
Linking multi-information display and the system ..... **35**

**2-2. Connectivity settings**  
Registering/Connecting a Bluetooth® device ..... **36**  
Setting Bluetooth® details **40**  
Wi-Fi® hotspot ..... **48**

**2-3. Apple CarPlay/Android Auto**

Apple CarPlay/Android Auto ..... **53**

**2-4. Other settings**  
General settings ..... **60**  
Voice settings ..... **64**  
Vehicle settings ..... **65**

**3**      **Navigation system**

**3-1. Basic operation**  
Navigation ..... **72**  
Map screen operation ..... **74**  
Map screen information ..... **76**  
Traffic information ..... **81**

**3-2. Destination search**  
Destination search operation ..... **84**  
Starting route guidance ..... **91**

**3-3. Route guidance**  
Route guidance screen ..... **95**  
Typical voice guidance prompts ..... **99**  
Editing route ..... **99**

**3-4. Setup**  
Navigation settings ..... **102**  
Detailed navigation settings ..... **106**  
Traffic settings ..... **109**  
Use of information accumulated by navigation system ..... **113**

**3-5. Tips for operating the navigation system**  
GPS (Global Positioning System) ..... **114**  
Map database version and covered area ..... **116**

**4 Audio/visual system****4-1. Basic operation**

- Quick reference..... **120**
- Some basics ..... **121**

**4-2. Radio operation**

- AM/FM/SiriusXM<sup>®</sup> Satellite  
Radio..... **125**
- Internet radio..... **133**

**4-3. Media operation**

- USB memory..... **134**
- iPod/iPhone (Apple CarPlay)  
..... **136**
- Android Auto ..... **139**
- Bluetooth<sup>®</sup> audio..... **140**

**4-4. Audio/visual remote controls**

- Steering switches ..... **144**

**4-5. Setup**

- Audio settings ..... **145**

**4-6. Tips for operating the audio/visual system**

- Operating information ... **147**

**5 Voice command system****5-1. Voice command system operation**

- Voice command system **158**
- Natural language understanding..... **161**
- Command list ..... **162**

**5-2. Mobile Assistant operation**

- Mobile Assistant ..... **167**

**6 Information****6-1. Information display**

- Receiving weather information..... **170**
- Data services settings ... **172**

**7 Peripheral monitoring system****7-1. Rear view monitor system**

- Rear view monitor system  
..... **174**
- Rear view monitor system  
precautions..... **176**
- Things you should know **181**

**7-2. Panoramic view monitor**

- Panoramic view monitor **183**
- Checking the front and  
around the vehicle ..... **186**
- Checking the sides of the  
vehicle ..... **188**
- Checking the rear and  
around the vehicle ..... **191**
- Panoramic view monitor pre-  
cautions..... **196**
- Things you should know **207**

**7-3. Multi-terrain Monitor**

- Multi-terrain Monitor ..... **209**
- Changing the Multi-terrain  
Monitor screen..... **213**
- Screen display and functions  
(for off-road) ..... **216**
- Screen display and functions  
(for on-road) ..... **225**
- Multi-terrain Monitor precau-  
tions..... **233**

1

2

3

4

5

6

7

8

9

Things you should know **244**

## 8 Phone

### 8-1. Phone operation (Hands-free system for cellular phones)

Quick reference..... **248**

Some basics ..... **249**

Placing a call using the Bluetooth® hands-free system ..... **253**

Receiving a call using the Bluetooth® hands-free system ..... **256**

Talking on the Bluetooth® hands-free system..... **257**

Bluetooth® phone message function..... **260**

### 8-2. Setup

Phone settings ..... **265**

### 8-3. What to do if...

Troubleshooting ..... **275**

## 9 Connected services

### 9-1. Connected services overview

Connected services ..... **280**

Type A: Function achieved by using a smartphone or DCM ..... **281**

Type B: Function achieved by using DCM and the system ..... **284**

Type C: Function achieved by using DCM ..... **285**

Type D: Function achieved by using DCM and a smartphone ..... **287**

### 9-2. Connected services operation

Toyota apps ..... **289**

Destination Assist ..... **292**

### 9-3. Setup

Toyota apps settings..... **294**

## Index

Alphabetical Index ..... **296**

1

2

3

4

5

6

7

8

9

## Introduction

### Navigation and multimedia system owner's manual

This manual explains the operation of the system. Please read this manual carefully to ensure proper use. Keep this manual in your vehicle at all times.

The screens shown in this manual may differ from the actual screen of the system depending on availability of functions, connected services subscription status, and map data available at the time this manual was produced.

The screens in this manual will also differ if the screen theme settings have been changed. (Theme setting: →P.60)

In some situations when changing between screens, it may take longer than normal for the screen to change, the screen may be blank momentarily or noise may be displayed.

Please be aware that the content of this manual may be different from the system in some cases, such as when the system's software is updated.

The company names and product names appearing on this manual are trademarks and registered trademarks of their

respective companies.

### Navigation system (Premium Audio)

The navigation system is one of the most technologically advanced vehicle accessories ever developed. The system receives satellite signals from the Global Positioning System (GPS) operated by the U.S. Department of Defense. Using these signals and other vehicle sensors, the system indicates your present position and assists in locating a desired destination.

The navigation system is designed to select efficient routes from your present starting location to your destination. The system is also designed to direct you to a destination that is unfamiliar to you in an efficient manner. The system uses AISIN AW maps. The calculated routes may not be the shortest nor the least traffic congested. Your own personal local knowledge or "short cut" may at times be faster than the calculated routes.

The navigation system's database includes Point of Interest categories to allow you to easily select destinations such as restaurants and hotels. If a destination is not in the database,

you can enter the street address close to it and the system will guide you there.

The system will provide both a visual map and audio instructions. The audio instructions will announce the distance remaining and the direction to turn in when approaching an intersection. These voice instructions will help you keep your eyes on the road and are timed to provide enough time to allow you to maneuver, change lanes or slow down.



Please be aware that all current vehicle navigation systems have certain limitations that may affect their ability to perform properly. The accuracy of the vehicle's position depends on satellite conditions, road configuration, vehicle condition or other circumstances. For more information on the limitations of the system, refer to page 114.

**TOYOTA MOTOR CORPORATION**

## Reading this manual

Explains symbols used in this manual

## Symbols in this manual

Symbols	Meanings
	<b>WARNING:</b> Explains something that, if not obeyed, could cause death or serious injury to people.
	<b>NOTICE:</b> Explains something that, if not obeyed, could cause damage to or a malfunction in the vehicle or its equipment.
	Indicates operating or working procedures. Follow the steps in numerical order.

## Symbols in illustrations

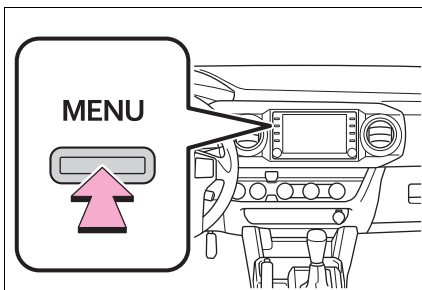

Symbols	Meanings
	Indicates the action (pushing, turning, etc.) used to operate switches and other devices.

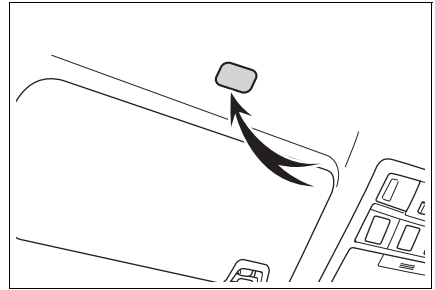

Symbols	Meanings
	Indicates the component or position being explained.

## Safety instruction (Audio)

To use this system in the safest possible manner, follow all the safety tips shown below.

Do not use any feature of this system to the extent it becomes a distraction and prevents safe driving. The first priority while driving should always be the safe operation of the vehicle. While driving, be sure to observe all traffic regulations.

Prior to the actual use of this system, learn how to use it and become thoroughly familiar with it. Read the entire manual to make sure you understand the system. Do not allow other peo-



ple to use this system until they have read and understood the instructions in this manual.

For your safety, some functions may become inoperable when driving. Unavailable screen buttons are dimmed.



### WARNING

- For safety, the driver should not operate the system while he/she is driving. Insufficient attention to the road and traffic may cause an accident.

### Safety instruction (Premium Audio)

To use this system in the safest possible manner, follow all the safety tips shown below.

This system is intended to assist in reaching the destination and, if used properly, can do so. The driver is solely responsible for the safe operation of your vehicle and the safety of your passengers.

Do not use any feature of this system to the extent it becomes a distraction and prevents safe driving. The first priority while driving should always be the safe operation of the vehicle. While driving, be sure to observe all traffic regulations.

Prior to the actual use of this system, learn how to use it and become thoroughly familiar with it. Read the entire manual to

make sure you understand the system. Do not allow other people to use this system until they have read and understood the instructions in this manual.

For your safety, some functions may become inoperable when driving. Unavailable screen buttons are dimmed.



### WARNING

- For safety, the driver should not operate the system while he/she is driving. Insufficient attention to the road and traffic may cause an accident.
- While driving, be sure to obey the traffic regulations and maintain awareness of the road conditions. If a traffic sign on the road has been changed, route guidance may not have the updated information such as the direction of a one way street.

While driving, listen to the voice instructions as much as possible and glance at the screen briefly and only when it is safe. However, do not totally rely on voice guidance. Use it just for reference. If the system cannot determine the current position correctly, there is a possibility of incorrect, late, or non-voice guidance.

The data in the system may occasionally be incomplete. Road conditions, including driving restrictions (no left turns, street closures, etc.) frequently change. Therefore, before fol-

Following any instructions from the system, look to see whether the instruction can be done safely and legally.

This system cannot warn about such things as the safety of an area, condition of streets, and availability of emergency services. If unsure about the safety of an area, do not drive into it.

Under no circumstances is this system a substitute for the driver's personal judgement.

Use this system only in locations where it is legal to do so. Some states/provinces may have laws prohibiting the use of video and navigation screens next to the driver.

**1-1. Basic function**

Buttons overview .....	12
“Menu” screen .....	14
Status icon .....	16
“Setup” screen .....	18
“Information” screen .....	19

**1-2. Navigation operation**

Operating the map screen .....	21
Guiding the route .....	22
Registering home .....	23

## Buttons overview

### Operations of each part

#### ► Premium Audio

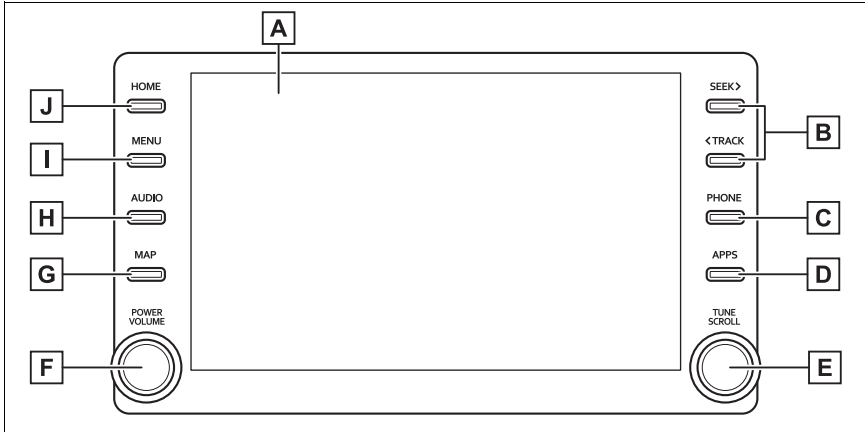

#### ► Audio

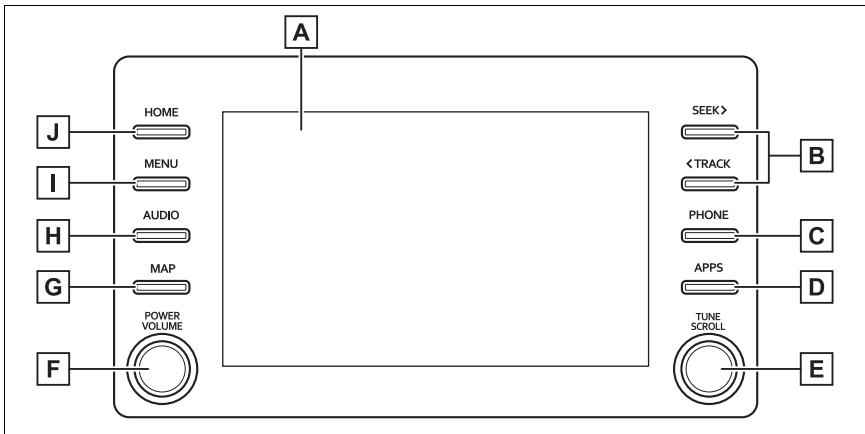

**A** By touching the screen with your finger, you can control the selected functions. (→P.27, 28)

**B** Press to seek up or down for a radio station or to access a desired track/file. (→P.125, 135, 137, 141)

**C** Press to access the Bluetooth® hands-free system. (→P.248)  
When an Apple CarPlay connection is established, press to display the phone application screen.\*1

- D** Press to display the Toyota apps screen.<sup>\*1, 2</sup> (→P.289)
- E** Turn to change the radio station or skip to the next or previous track/file. (→P.125, 135, 137, 141)
- F** Press to turn the audio/visual system on and off, and turn it to adjust the volume. Press and hold to restart the system. (→P.26, 121)
- G** Press to display the map screen and repeat a voice guidance.<sup>\*3</sup> (→P.72)  
If a turn-by-turn navigation application has been downloaded to a connected smartphone, the application will be displayed and can be used.<sup>\*1, 4, 5</sup>  
When an Apple CarPlay/Android Auto connection is established, press to display the Maps application screen.<sup>\*4</sup>
- H** Press to display the audio/visual system screen. (→P.120, 121)
- I** Press to display the “Menu” screen. (→P.14)
- J** Press to display the home screen. (→P.29)

<sup>\*1</sup>: This function is not made available in some countries or areas.

<sup>\*2</sup>: When an Apple CarPlay/Android Auto connection is established, this function will be unavailable.

<sup>\*3</sup>: Premium Audio only

<sup>\*4</sup>: Audio only

<sup>\*5</sup>: For details about a turn-by-turn navigation application, refer to <https://www.toyota.com/audio-multimedia> in the United States, <https://www.toyota.ca/connected> in Canada, and <http://www.toyotapr.com/audio-multimedia> in Puerto Rico.

## “Menu” screen

### “Menu” screen operation

Press the “MENU” button to display the “Menu” screen.

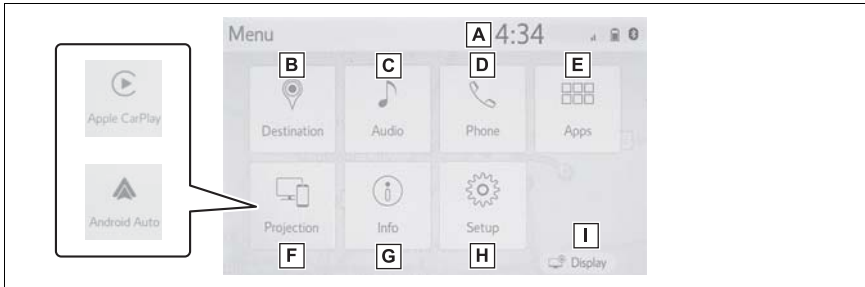

- A** Displays the clock. Select to display the clock settings screen. (→P.61)
- B** Select to display the destination screen.\*1 (→P.84)
- C** Select to display the audio control screen. (→P.120)
- D** Select to display the hands-free operation screen. (→P.248)
  - When an Apple CarPlay connection is established, select to display the Phone application screen.\*2 (→P.53)
- E** Select to display the Toyota apps screen.\*2, 3 (→P.289)
- F** When an Apple CarPlay/Android Auto connection is established and this button displays “Apple CarPlay”/“Android Auto”, select to display the home screen of Apple CarPlay/Android Auto.\*2 (→P.53)
- G** Select to display the information screen.\*4 (→P.19)
  - Select to display the fuel consumption screen.\*5, 6
- H** Select to display the “Setup” screen. (→P.18)
- I** Select to adjust the contrast, brightness, etc. of the display. (→P.33)

\*1: Premium Audio only

\*2: This function is not made available in some countries or areas.

\*3: When an Apple CarPlay/Android Auto connection is established, this function will be unavailable.

- \*4: Vehicles equipped with DCM
- \*5: Vehicles equipped without DCM
- \*6: Refer to the “OWNER’S MANUAL”

## Status icon

Status icons are displayed at the top of the screen.

### Status icon explanation



**A** Weather alert display<sup>\*1, 2</sup>  
(→P.170)

- Select to display important weather information for the current location or along the route.

**B** Indicate during data communication performed via Data Communication Module (DCM)<sup>\*2</sup>

**C** The reception level of Data Communication Module (DCM) display<sup>\*2</sup> (→P.16)

**D** The reception level of the connected phone display (→P.16)

**E** Remaining battery charge display (→P.17)

**F** Bluetooth<sup>®</sup> phone connection condition display (→P.17)

**G** Wi-Fi<sup>®</sup> connection condition display<sup>\*2</sup> (→P.48)

\*1: Premium Audio only

\*2: This function is not made available in some countries or areas.

- The number of status icons that can be displayed differs depending on the displayed screen.

### Reception level display

The level of reception does not always correspond with the level displayed on the cellular phone. The level of reception may not be displayed depending on the phone you have.

When the cellular phone is out of the service area or in a place inaccessible by radio waves,  is displayed.

“Rm” is displayed when receiving in a roaming area. While roaming, display “Rm” top-left on the icon.



The receiving area may not be displayed depending on the type of Bluetooth<sup>®</sup> phone you have.





- While connected with cellular phone

Reception Level	Indicators
Poor	
Excellent	

- While using Data Communication Module (DCM)

Reception Level	Indicators
Poor	
Excellent	

- While using Wi-Fi<sup>®</sup> hotspot

Reception Level	Indicators
No connection	
Connected	



- When Wi-Fi<sup>®</sup> hotspot is off, no item is displayed.

### Remaining battery charge display

The amount displayed does not always correspond with the amount displayed on the Bluetooth<sup>®</sup> device.

The amount of battery charge left may not be displayed depending on the type of the Bluetooth<sup>®</sup> device connected.

This system does not have a charging function.

Remaining charge	Indicators
Empty	
Full	

### Bluetooth<sup>®</sup> connection condition display

An antenna for the Bluetooth<sup>®</sup> connection is built into the instrument panel.



The condition of the Bluetooth<sup>®</sup> connection may deteriorate and the system may not function when a Bluetooth<sup>®</sup> phone is used in the following conditions and/or places:

The cellular phone is obstructed by certain objects (such as when it is behind the seat or in the glove box or console box).

The cellular phone is touching or is covered with metal materials.

Leave the Bluetooth<sup>®</sup> phone in a place where the condition of the Bluetooth<sup>®</sup> connection is good.

Indicators	Conditions
 (Blue)	Indicates that the condition of the Bluetooth <sup>®</sup> connection is good.

Indicators	Conditions
 (Gray)	While in this condition, sound quality during phone calls may deteriorate.
	Indicates that the cellular phone is not connected via Bluetooth®.

## “Setup” screen

### “Setup” screen

Press the “MENU” button, then select “Setup” to display the “Setup” screen. The items shown on the “Setup” screen can be set.

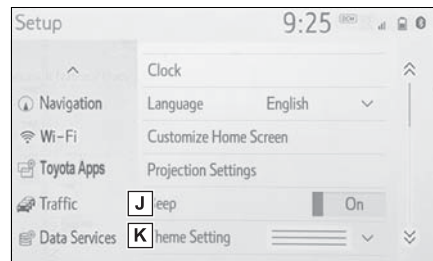
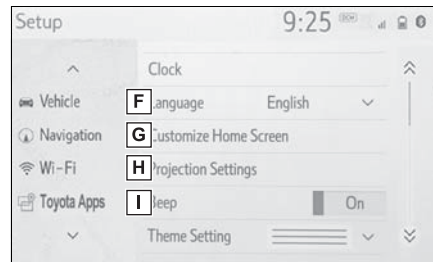
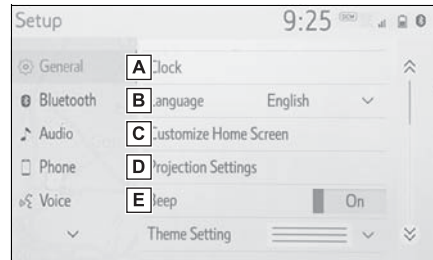

- A** Select to change the selected language, operation sound settings, etc. (→P.60)
- B** Select to set Bluetooth® device and Bluetooth® system settings. (→P.40)

- C** Select to set audio settings. (→P.145)
- D** Select to set the phone sound, contacts, message settings, etc. (→P.265)
- E** Select to set the voice settings. (→P.64)
- F** Select to set vehicle information such as maintenance information. (→P.65)
- G** Select to set memory points (home, favorites entries, areas to avoid), or navigation details.\*<sup>1</sup> (→P.102)
- H** Select to set Wi-Fi® connection settings.\*<sup>2, 3</sup> (→P.49)
- I** Select to set Toyota apps settings.\*<sup>3</sup> (→P.294)
- J** Select to set traffic information settings.\*<sup>1, 3</sup> (→P.109)
- K** Select to set data services settings.\*<sup>1, 3</sup> (→P.172)

\*<sup>1</sup>: Premium Audio only

\*<sup>2</sup>: Vehicles equipped with DCM

\*<sup>3</sup>: This function is not made available in some countries or areas.

## “Information” screen\*

\*: Vehicles equipped with DCM

## “Information” screen

Useful information, such as the fuel consumption, weather, etc., is available on the information screen.

The information screen can be reached by the following methods:

- 1 Press the “MENU” button.
- 2 Select “Info”.
- 3 Select the desired item.

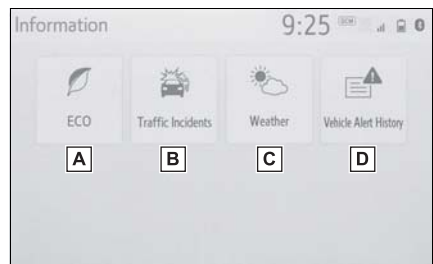

- A** Select to display the fuel consumption screen.\*<sup>1</sup>
- B** Select to display traffic information.\*<sup>2, 3</sup> (→P.81)
- C** Select to display weather information.\*<sup>2, 3</sup> (→P.170)
- D** Select to display the vehicle alert history.\*<sup>3</sup>

\*<sup>1</sup>: Refer to the “OWNER’S MANUAL”

\*<sup>2</sup>: Premium Audio only

\*<sup>3</sup>: This function is not made avail-

able in some countries or areas.

## Operating the map screen\*

\*: Premium Audio only

### Displaying the current position of the vehicle on the map screen

- 1 Press the "MAP" button.

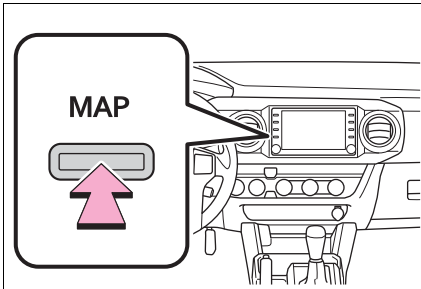

- The current position of the vehicle is displayed on the map screen.



### ■ Displaying the map screen

The following operations can also be performed.

- Changing the map direction (→P.75)
- Displaying 3D map (→P.75)
- Changing the map color (→P.107)
- Displaying the micro city map

(→P.74)

### Moving the map screen

- 1 Select the desired point on the map screen.



- The map screen can be scrolled by touching, dragging or flicking it. (→P.27)

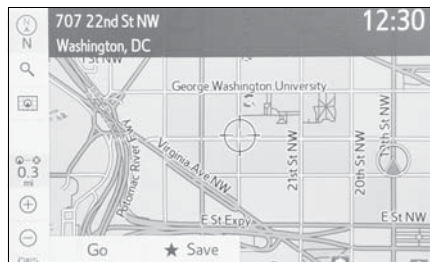

- Press the "MAP" button to return to the current position.

### Zooming in/out the map

#### ■ Zooming in the map

- 1 Select  $\oplus$  or pinch out on the map screen. (→P.74)

#### ■ Zooming out the map

- 1 Select  $\ominus$  or pinch in on the map screen. (→P.74)

## Guiding the route\*

\*: Premium Audio only

### Setting the destination

1 Press the “MAP” button.

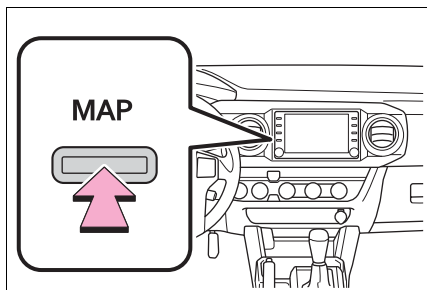

2 Select .

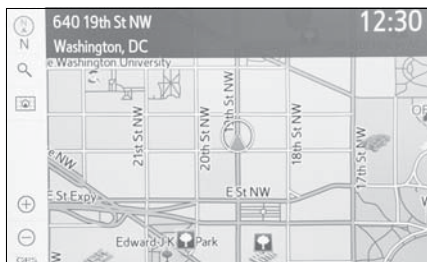

3 There are different kinds of methods to search for a destination. (→P.84)

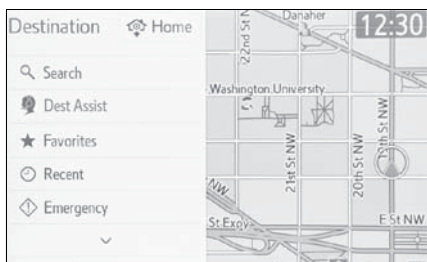

4 Select “Go”.

- Check that the route overview is displayed. (→P.92)

5 Select “OK”.

- Selecting routes other than the one recommended (→P.92)
- Guidance to the destination is displayed on the screen and can be heard via voice guidance.

### Deleting destinations

When route guidance is no longer necessary, such as when you know the rest of the route to your destination, the destination can be deleted.

1 Press the “MAP” button.

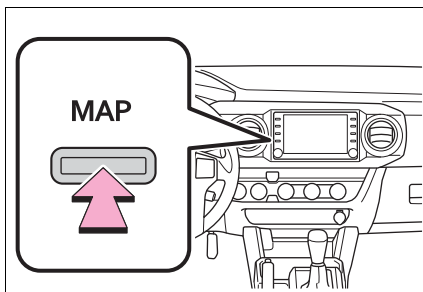

2 Select .

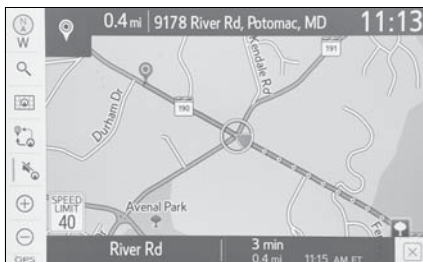

3 Select “Yes” when the confirmation screen appears.

- When more than 1 destination has been set, a list will be dis-

played on the screen. Select the item(s) to be deleted.

## Registering home\*

\*: Premium Audio only

### Registering home

- 1 Turn the engine switch to ACC or ON.
- 2 Press the "MAP" button.

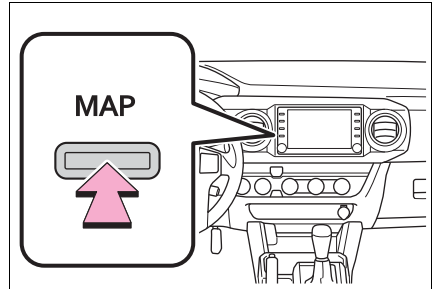

- 3 Select  .



- 4 Search for your home.
  - There are different kinds of methods to search for your home. (→P.84)
- 5 Select "Enter".
- 6 Select "OK".
  - Registration of home is complete.
  - Registering home in a different way  
→P.102

- Editing the name, location, phone number and icon  
→P.102
- Setting home as the destination  
→P.85

### Setting home as the destination

- 1 Press the “MAP” button.

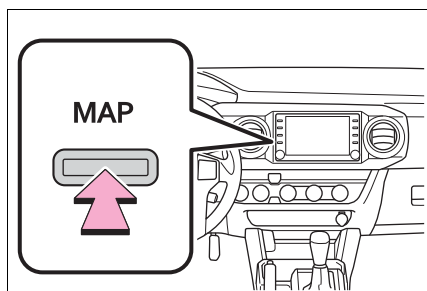

- 2 Select  HOME  
12:12 PM ET



- Guidance to the destination is displayed on the screen and can be heard via voice guidance.
- Setting home as the destination in a different way →P.102



- 2-1. Basic information before operation**
- Initial screen ..... **26**
  - Touch screen ..... **27**
  - Home screen ..... **29**
  - Entering letters and numbers/list screen operation ..... **30**
  - Screen adjustment ..... **33**
  - Linking multi-information display and the system. **35**
- 2-2. Connectivity settings**
- Registering/Connecting a Bluetooth<sup>®</sup> device ..... **36**
  - Setting Bluetooth<sup>®</sup> details ..... **40**
  - Wi-Fi<sup>®</sup> hotspot ..... **48**
- 2-3. Apple CarPlay/Android Auto**
- Apple CarPlay/Android Auto ..... **53**
- 2-4. Other settings**
- General settings ..... **60**
  - Voice settings ..... **64**
  - Vehicle settings ..... **65**

## Initial screen

When the engine switch is in ACC or ON, the initial screen will be displayed and the system will begin operating.

## Caution screen

After a few seconds, the caution screen will be displayed.

After about 5 seconds or selecting “Continue”, the caution screen automatically switches to the next screen.



### WARNING

- When the vehicle is stopped with the engine running, always apply the parking brake for safety.

## Maintenance information\*

\*: Premium Audio only

This system reminds users when to replace certain parts or components and shows dealer information (if registered) on the screen.

When the vehicle reaches a previously set driving distance or date specified for a scheduled maintenance check, the maintenance remainder screen will be displayed when the system is turned on.

- To prevent this screen from

being displayed again, select “Do Not Tell Me Again”.

- To register maintenance information: →P.66
- If  is selected, the registered phone number can be called.

## Restarting the system

When system response is extremely slow, the system can be restarted.

- 1 Press and hold the “POWER VOLUME” knob for 3 seconds or more.

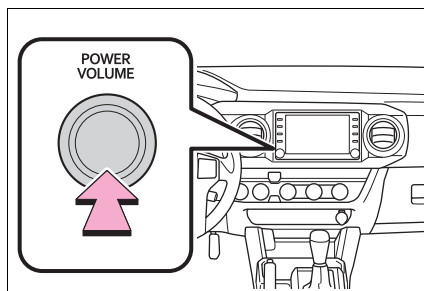

## Touch screen

### Touch screen gestures

Operations are performed by touching the touch screen directly with your finger.

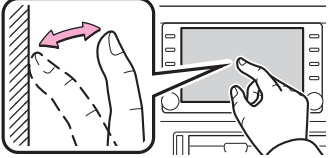
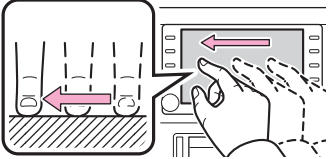
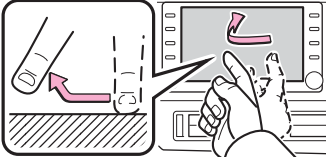
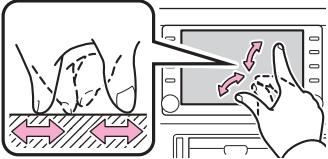
Operation method	Outline	Main use
	<ul style="list-style-type: none"> <li>• Touch</li> </ul> <p>Quickly touch and release once.</p>	<ul style="list-style-type: none"> <li>• Selecting an item on the screen</li> </ul>
	<ul style="list-style-type: none"> <li>• Drag<sup>*1</sup></li> </ul> <p>Touch the screen with your finger, and move the screen to the desired position.</p>	<ul style="list-style-type: none"> <li>• Scrolling the lists</li> <li>• Scrolling the map screen</li> </ul>
	<ul style="list-style-type: none"> <li>• Flick<sup>*1</sup></li> </ul> <p>Quickly move the screen by flicking with your finger.</p>	<ul style="list-style-type: none"> <li>• Scrolling the main screen page</li> <li>• Scrolling the map screen</li> </ul>
	<ul style="list-style-type: none"> <li>• Pinch in/Pinch out</li> </ul> <p>Slide fingers toward each other or apart on the screen.</p>	<ul style="list-style-type: none"> <li>• Changing the scale of the map<sup>*2</sup></li> </ul>

<sup>\*1</sup>: The above operations may not be performed on all screens.



<sup>\*2</sup>: The Apple CarPlay Maps application is not compatible with pinch multi-touch gestures.

- Flick operations may not be performed smoothly at high altitudes.

## Touch screen operation

**This system is operated mainly by the buttons on the screen. (Referred to as screen buttons in this manual.)**

**When a screen button is touched, a beep sounds. (To set the beep sound: →P.60)**

- If the system does not respond to touching a screen button, move your finger away from the screen and then touch it again.
- Dimmed screen buttons cannot be operated.
- The displayed image may become darker and moving images may be slightly distorted when the screen is cold.
- In extremely cold conditions, the screen may not be displayed and the data input by a user may be deleted. Also, the screen buttons may be harder than usual to depress.
- When you look at the screen through polarized material such as polarized sunglasses, the screen may be dark and hard to see. If so, look at the screen from different angles, adjust the screen settings on the display settings screen or take off your sunglasses.
- When  is displayed on the screen, select  to return to the previous screen.



## NOTICE

- To prevent damaging the screen, lightly touch the screen buttons with your finger.
- Do not use objects other than your finger to touch the screen.
- Wipe off fingerprints using a glass cleaning cloth. Do not use chemical cleaners to clean the screen, as they may damage the touch screen.

## Capacitive touch screen buttons

The operable areas of the capacitive touch screen buttons use capacitive touch sensors and may not operate properly in the following situations:

- If the screen is dirty or wet
- If a source of strong electromagnetic waves is brought near the screen
- If a glove is worn during operation
- If the screen is touched by a fingernail
- If a stylus is used to operate the buttons
- If your palm touches the operable area of another button during operation
- If a button is touched quickly
- If the operable part of a capacitive touch screen button is touched by or covered

with a metal object, such as the following, it may not operate properly:

- Magnetic isolation cards
- Metallic foil, such as the inner packaging of a cigarette box
- Metallic wallets or bags
- Coins
- Discs, such as a CD or DVD
- If the operable part of a capacitive touch screen button is wiped, it may operate unintentionally.
- If the capacitive touch screen button is being touched when the engine switch is changed to ACC or ON, the button may not operate properly. In this case, remove anything touching the button, turn the engine switch off and then turn it to ACC or ON, or restart the system by press and hold the "POWER VOLUME" knob for 3 seconds or more.

- 
- Capacitive touch screen button sensor sensitivity can be adjusted. (→P.60)

## Home screen

On the home screen, multiple screens, such as the audio/visual system screen, hands-free screen and clock screen, can be displayed simultaneously.

## Home screen operation

- 1 Press the "HOME" button.

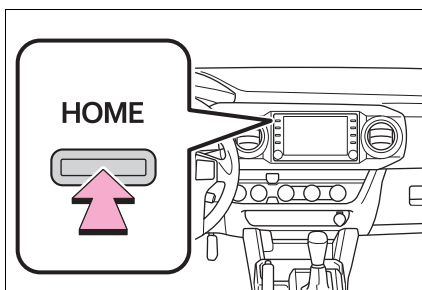

- 2 Check that the home screen is displayed.

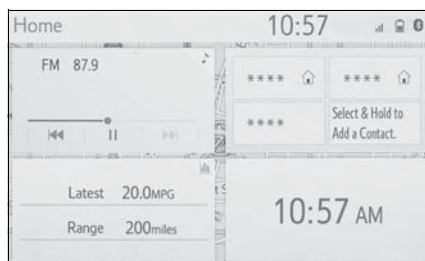

- Selecting a screen will display it full screen.
- 
- The display information and area on the home screen can be customized.
  - The home screen can be set to several types of split layouts.

## Customizing the home screen

The display information/area on the home screen and the home screen layout can be changed.

- 1 Press the "MENU" button.
- 2 Select "Setup".
  - If the general settings screen is not displayed, select "General".
- 3 Select "Customize Home Screen".
- 4 Select the items to be set.

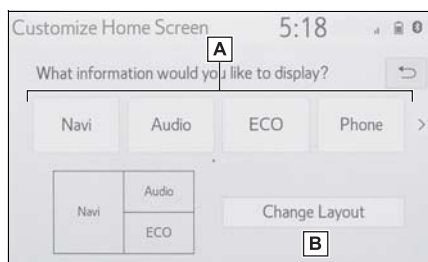

- A** Select to change the display information and area on the home screen.
- B** Select to change the home screen layout.

## Entering letters and numbers/list screen operation

### Entering letters and numbers

When searching by an address, name, etc., or entering data, letters and numbers can be entered via the screen.

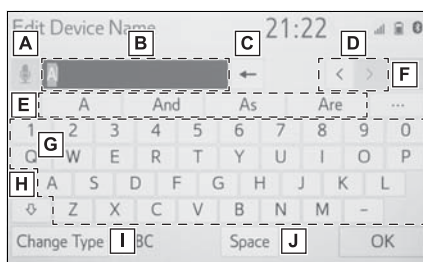

- A** When this icon is displayed, select to enable the dictation function.\* (English only) (→P.161)
- B** Text field. Entered character(s) will be displayed.
- C** Select to erase one character.  
Select and hold to continue erasing characters.
- D** Select to move the cursor.
- E** Select to choose predictive text candidate for entered text. (→P.31)
- F** Select to display a list of predictive text candidates when there is more than one. (→P.31)

- G** Select to enter desired characters.
  - H** Select to enter characters in lower case or in upper case.
  - I** Select to change character types. (→P.31)
  - J** Select to make a space on cursor.
- \*: Premium Audio only. This function is not made available in some countries or areas.

- Keyboard layout can be changed. (→P.60)

## Changing character type

- 1 Select "Change Type".

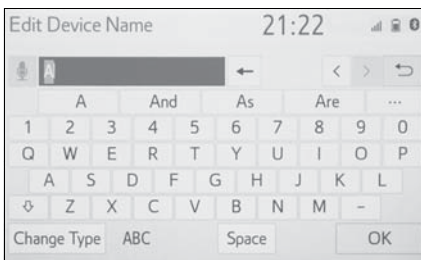

- 2 Select the desired character.



- Depending on the screen being displayed, it may not be possible to change keyboard characters.

## Displaying predictive text candidates

When text is input, the system predicts the text that may complete the currently unconfirmed text and displays predictive replacement candidates that match the beginning of the text.

- 1 Input text.
- 2 Select the desired candidate.

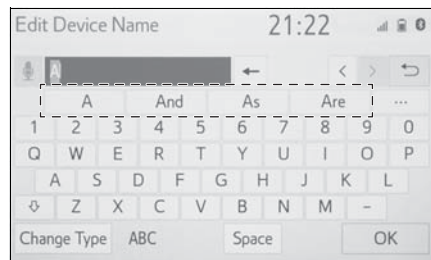

- To select a candidate that is not displayed, select **...**, and then select the desired predictive replacement candidate.

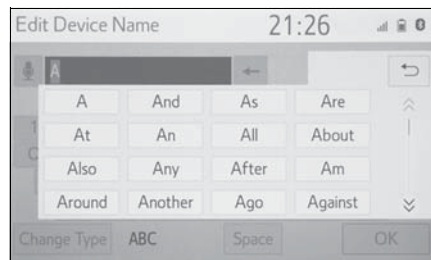

## List screen

The list screen may be displayed after entering characters. When a list is displayed, use the appropriate screen button to scroll through the list.

## Scrolling list screen

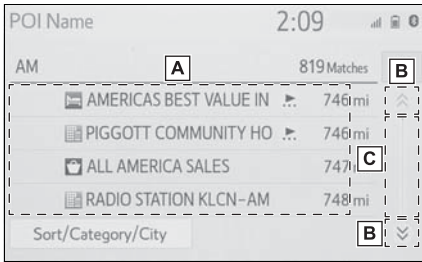

- A** To scroll up/down the list, flick the list up/down.
- B** Select to skip to the next or previous page. Select and hold or to scroll through the displayed list.
- C** Indicates the position of the displayed entries in the entire list. To scroll up/down pages, drag the bar.

- If appears to the right of an item name, the complete name is too long to display.
- Select to scroll to the end of the name.
- Select to move to the beginning of the name.
- Matching items from the database are listed even if the entered address or name is incomplete.
- The list will be displayed automatically if the maximum number of characters is entered or matching items can be displayed on a single list screen.
- The number of matching items is shown on the right side of the screen. If the number of matching items is more than 999, the sys-

tem displays “\*\*\*” on the screen.

## Sorting

The order of a list displayed on the screen can be sorted in the order of distance from the current location, date, category, etc.

- 1 Select “Sort”.

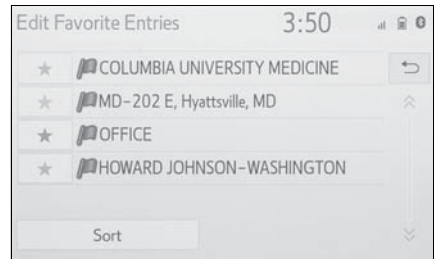

- 2 Select the desired sorting criteria.

## Searching a list

Items are displayed in the list with the most similar results of the search at the top.

- 1 Select .





## 2 Input text.



- 3 Select "Search".
- 4 The list is displayed.

## Screen adjustment

The contrast and brightness of the screen display and the image of the camera display can be adjusted. The screen can also be turned off, and/or changed to either day or night mode.

(For information regarding audio/visual screen adjustment: →P.123)

## Displaying the screen adjustment screen

- 1 Press the "MENU" button.

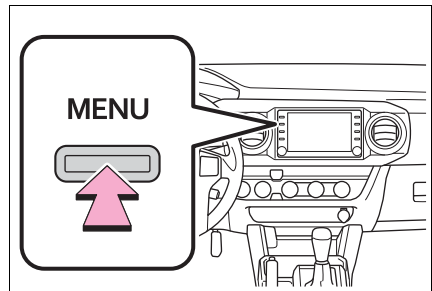

- 2 Select "Display".
- 3 Select the desired items to be set.



- A Select to turn the screen off. To turn it on, press any but-

ton.

- B** Select to turn day mode on/off. (→P.34)
- C** Select to adjust the screen display. (→P.34)
- D** Select to adjust the camera display.

- When the screen is viewed through polarized sunglasses, a rainbow pattern may appear on the screen due to optical characteristics of the screen. If this is disturbing, please operate the screen without polarized sunglasses.

### Changing between day and night mode

Depending on the position of the headlight switch, the screen changes to day or night mode. This feature is available when the headlight is switched on.

- 1 Select "Day Mode".

- If the screen is set to day mode with the headlight switch turned on, this condition is memorized even with the engine turned off.

### Adjusting the contrast/brightness

The contrast and brightness of the screen can be adjusted according to the brightness of your surroundings.

- 1 Select "General" or "Camera".
- 2 Select the desired item.

- "Display (General)" screen only: Select "<" or ">" to select the desired display.

- "Contrast"

"+": Select to strengthen the contrast of the screen.

"-": Select to weaken the contrast of the screen.

- "Brightness"

"+": Select to brighten the screen.

"-": Select to darken the screen.

## Linking multi-information display and the system

The following functions of the system are linked with the multi-information display in the instrument cluster:

- Audio
- Phone\*

etc.

These functions can be operated using the multi-information display control switches on the steering wheel. For details, refer to “OWNER’S MANUAL”.

\*: When an Apple CarPlay connection is established, this function will be unavailable.

## Registering/Connecting a Bluetooth® device

To use the hands-free system, it is necessary to register a Bluetooth® phone with the system.

Once the phone has been registered, it is possible to use the hands-free system.

This operation cannot be performed while driving.

When an Apple CarPlay connection is established, Bluetooth® functions of the system will become unavailable and any connected Bluetooth® devices will be disconnected.

When connecting to Android Auto, a Bluetooth® connection will be made automatically.

When an Android Auto connection is established, some Bluetooth® functions other than hands-free system cannot be used.

## Registering a Bluetooth® phone for the first time

### ■ Registering from the system

- 1 Turn the Bluetooth® connection setting of your cellular phone on.
  - This function is not available when Bluetooth® connection setting of your cellular phone is set to off.
- 2 Press the “MENU” button.

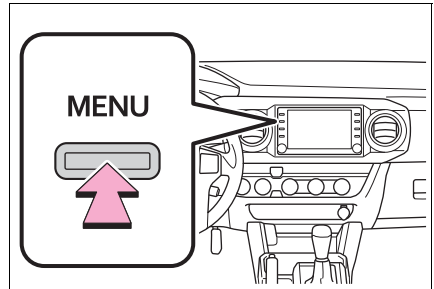

- 3 Select “Phone”.
  - Operations up to this point can also be performed by pressing the “PHONE” button on the instrument panel.
- 4 Select “Yes” to register a phone.

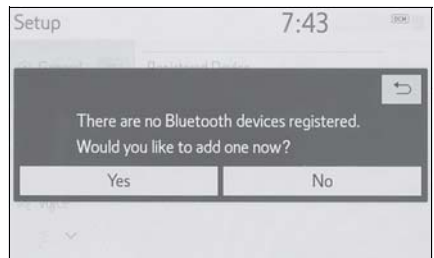

- 5 Select the desired Bluetooth® device.



- If the desired Bluetooth® phone is not on the list, select “If you cannot find...” and follow the guidance on the screen. (→P.38)
- 6 Register the Bluetooth® device using your Bluetooth® device.



- For details about operating the Bluetooth® device, see the manual that comes with it.
- A PIN code is not required for SSP (Secure Simple Pairing) compatible Bluetooth® devices. Depending on the type of Bluetooth® device being connected, a message confirming registration may be displayed on the Bluetooth® device's screen.

Respond and operate the Bluetooth® device according to the confirmation message.

- 7 Check that the following screen is displayed, indicating pairing was successful (a Bluetooth® link has been established but registration is not yet complete).



- The system is connecting to the registered device.
  - At this stage, the Bluetooth® functions are not yet available.
- 8 Check that “Connected” is displayed and registration is complete.



- If an error message is displayed, follow the guidance on the screen to try again.
- If a cellular phone does not operate properly after being con-

nected, turn the cellular phone off and on and then connect it again.

## ■ Registering from phone

1 Select “If you cannot find...”.



2 Select “Register from Phone”.

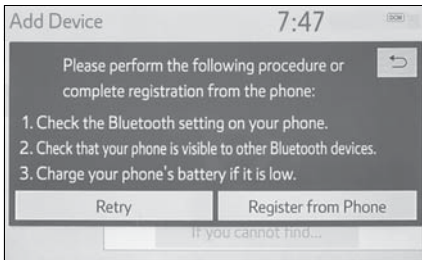

3 Check that the following screen is displayed, and register the Bluetooth® device using your Bluetooth® device.

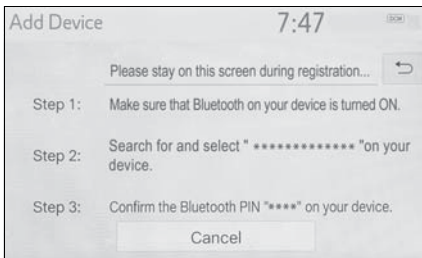

- For details about operating the Bluetooth® device, see the manual that comes with it.
- A PIN code is not required for

SSP (Secure Simple Pairing) compatible Bluetooth® devices. Depending on the type of Bluetooth® device being connected, a message confirming registration may be displayed on the Bluetooth® device's screen. Respond and operate the Bluetooth® device according to the confirmation message.

4 Follow the steps in “Registering a Bluetooth® phone for the first time” from step 7. (→P.36)

## Registering a Bluetooth® audio player for the first time

To use the Bluetooth® audio, it is necessary to register an audio player with the system.

Once the player has been registered, it is possible to use the Bluetooth® audio.

This operation cannot be performed while driving.

For details about registering a Bluetooth® device: →P.43

- 1 Turn the Bluetooth® connection setting of your audio player on.
- This function is not available when the Bluetooth® connection setting of your audio

player is set to off.

2 Press the “AUDIO” button.

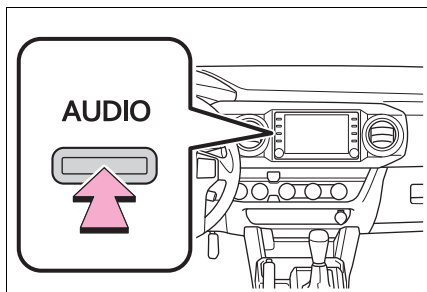

3 Select “Source” on the audio screen or press “AUDIO” button again.

4 Select “Bluetooth”.

5 Select “Yes” to register an audio player.

6 Follow the steps in “Registering a Bluetooth® phone for the first time” from step 5. (→P.36)

## Profiles

This system supports the following services.

### ■ Bluetooth® Core Specification

- Ver. 2.0 (Recommended: Ver. 4.2)

### ■ Profiles

- HFP (Hands Free Profile) Ver. 1.0 (Recommended: Ver. 1.7)
  - This is a profile to allow hands-free phone calls using a cellular phone. It has outgoing and incoming call functions.

- OPP (Object Push Profile) Ver. 1.1 (Recommended: Ver. 1.2)

- This is a profile to transfer contacts data.

- PBAP (Phone Book Access Profile) Ver. 1.0 (Recommended: Ver. 1.2)

- This is a profile to transfer phone-book data.

- MAP (Message Access Profile) Ver. 1.0 (Recommended: Ver. 1.2)

- This is a profile to use phone message functions.

- SPP (Serial Port Profile) Ver. 1.1 (Recommended: Ver. 1.2)

- This is a profile to use the Toyota audio multimedia function.

- A2DP (Advanced Audio Distribution Profile) Ver. 1.0 (Recommended: Ver. 1.3)

- This is a profile to transmit stereo audio or high quality sound to the audio/visual system.

- AVRCP (Audio/Video Remote Control Profile) Ver. 1.0 (Recommended: Ver. 1.6)

- This is a profile to allow remote control the A/V equipment.

- 
- This system is not guaranteed to operate with all Bluetooth® devices.

- If your cellular phone does not support HFP, registering the Bluetooth® phone or using OPP, PBAP, MAP or SPP profiles individually will not be possible.

- If the connected Bluetooth®

device version is older than recommended or incompatible, the Bluetooth® device function may not work properly.

- Refer to <https://www.toyota.com/audio-multimedia> in the United States, <https://www.toyota.ca/connected> in Canada, and <http://www.toyotapr.com/audio-multimedia> in Puerto Rico, to find approved Bluetooth® phones for this system.
- Certification



Bluetooth is a registered trademark of Bluetooth SIG, Inc.

## Setting Bluetooth® details

### Displaying the Bluetooth® setup screen

- 1 Press the “MENU” button.

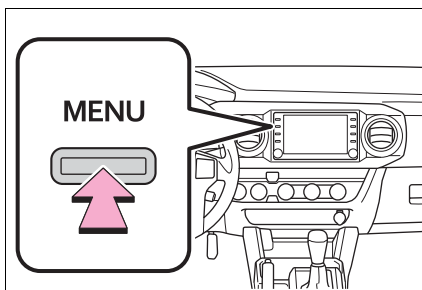

- 2 Select “Setup”.
- 3 Select “Bluetooth”.
- 4 Select the desired item to be set.



### Bluetooth® setup screen



- A** Connecting a Bluetooth®



device and editing the Bluetooth® device information (→P.41, 43)

- B** Registering a Bluetooth® device (→P.43)
- C** Deleting a Bluetooth® device (→P.43)
- D** Setting the Bluetooth® system (→P.45)

### Connecting a Bluetooth® device

Up to 5 Bluetooth® devices (Phones (HFP) and audio players (AVP)) can be registered.

If more than 1 Bluetooth® device has been registered, select which device to connect to.

- 1 Display the Bluetooth® settings screen. (→P.40)
- 2 Select “Registered Device”.
- 3 Select the device to be connected.

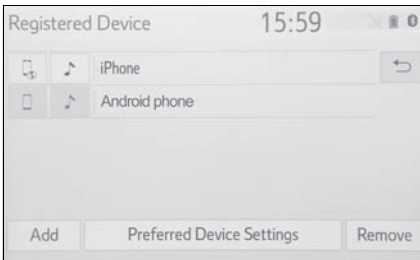



“Add”: Registering a Bluetooth® device (→P.43)

“Preferred Device Settings” Select to change the automatic connection priority of the registered Bluetooth®

devices. (→P.46)

“Remove” Deleting a Bluetooth® device (→P.43)

: Phone

: Audio player

: Phone/Toyota apps services

- The profile icon for a currently connected device will be displayed in color.
- Selecting a profile icon which is not currently connected will switch the connection to the function.

- If the desired Bluetooth® device is not on the list, select “Add New Device” to register the device. (→P.43)

- 4 Select the desired connection.



- “Device Info”: Select to confirm and change the Bluetooth® device information. (→P.43)

▶ When another Bluetooth® device is connected

- To disconnect the Bluetooth® device, select “Yes”.

5 Check that a confirmation screen is displayed when the connection is complete.

- If an error message is displayed, follow the guidance on the screen to try again.

---

- It may take time if the device connection is carried out during Bluetooth® audio playback.

- Depending on the type of Bluetooth® device being connected, it may be necessary to perform additional steps on the device.

- When disconnecting a Bluetooth® device, it is recommended to disconnect using the system.

### ■ Connecting a Bluetooth® device in a different way (from phone top screen)

→P.250

### ■ Connecting a Bluetooth® device in a different way (from phone setup screen)

→P.265

### ■ Connecting a Bluetooth® device in a different way (from Bluetooth® audio screen)

→P.142

### ■ Auto connection mode

To turn auto connection mode on, set “Bluetooth Power” to on. (→P.45) Leave the Bluetooth® device in a location where the connection can be established.

- When the engine switch is in

ACC or ON, the system searches for a nearby registered device.

- The system will connect with the registered device that was last connected, if it is nearby. When automatic connection priority is set to on and there is more than one registered Bluetooth® phone available, the system will automatically connect to the Bluetooth® phone with the highest priority. (→P.45)

### ■ Connecting manually

When the auto connection has failed or “Bluetooth Power” is turned off, it is necessary to connect the Bluetooth® device manually.

- 1 Display the Bluetooth® settings screen. (→P.40)

- 2 Follow the steps in “Connecting a Bluetooth® device” from step 2. (→P.41)

### ■ Reconnecting the Bluetooth® phone

If a Bluetooth® phone is disconnected due to poor reception from the Bluetooth® network when the engine switch is in ACC or ON, the system automatically reconnects the Bluetooth® phone.

## Registering a Bluetooth® device

Up to 5 Bluetooth® devices can be registered.

Bluetooth® compatible phones (HFP) and audio players (AVP) can be registered simultaneously.

This operation cannot be performed while driving.

- 1 Display the Bluetooth® settings screen. (→P.40)
- 2 Select “Add New Device”.
  - ▶ When another Bluetooth® device is connected
  - To disconnect the Bluetooth® device, select “Yes”.
  - ▶ When 5 Bluetooth® devices have already been registered
  - A registered device needs to be replaced. Select “Yes”, and select the device to be replaced.
- 3 Follow the steps in “Registering a Bluetooth® phone for the first time” from step 5. (→P.36)

## Deleting a Bluetooth® device

This operation cannot be performed while driving.

- 1 Display the Bluetooth® settings screen. (→P.40)

- 2 Select “Remove Device”.
- 3 Select the desired device.

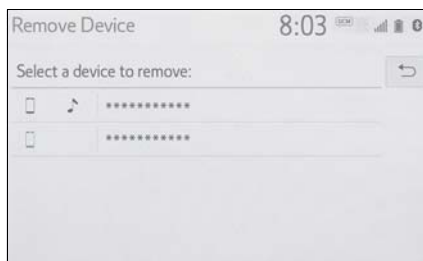

- 4 Select “Yes” when the confirmation screen appears.
- 5 Check that a confirmation screen is displayed when the operation is complete.

- When deleting a Bluetooth® phone, the contact data will be deleted at the same time.

## Editing the Bluetooth® device information

The Bluetooth® device’s information can be displayed on the screen. The displayed information can be edited.

This operation cannot be performed while driving.

- 1 Display the Bluetooth® settings screen. (→P.40)
- 2 Select “Registered Device”.
- 3 Select the desired device to be edited.

## 4 Select "Device Info".

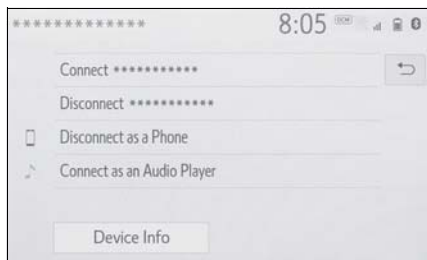

## 5 Confirm and change the Bluetooth® device information.



**A** The name of the Bluetooth® device is displayed. It can be changed to a desired name. (→P.44)

**B** Select to set the Bluetooth® audio player connection method. (→P.44)

**C** Device address is unique to the device and cannot be changed.

**D** Phone number is unique to the Bluetooth® phone and cannot be changed.

**E** Compatibility profile is unique to the Bluetooth® device and cannot be changed.

**F** Select to reset all setup items.

● If 2 Bluetooth® devices have been registered with the same device name, the devices can be distinguished referring to the device's address.

● Depending on the type of Bluetooth® phone, some information may not be displayed.

### Changing a device name

1 Select "Device Name".

2 Enter the name and select "OK".

● Even if the device name is changed, the name registered in your Bluetooth® device does not change.

### Setting audio player connection method

1 Select "Connect Audio Player From".

- 2 Select the desired connection method.



“Vehicle”: Select to connect the audio player from the vehicle’s audio/visual system.

“Device”: Select to connect the vehicle’s audio/visual system from the audio player.

- Depending on the audio player, the “Vehicle” or “Device” connection method may be best. As such, refer to the manual that comes with the audio player.

### “Detailed Settings” screen

The Bluetooth® settings can be confirmed and changed.

- 1 Display the Bluetooth® settings screen. (→P.40)
- 2 Select “Detailed Settings”.

- 3 Select the desired item to be set.



- A Select to set Bluetooth® connection on/off. (→P.45)
- B Select to change the automatic connection priority of the registered Bluetooth® devices. (→P.46)
- C Select to edit the system information. (→P.46)
- D Select to reset all setup items.

### Changing “Bluetooth Power”

- 1 Select “Bluetooth Power”.

When “Bluetooth Power” is on:

The Bluetooth® device is automatically connected when the engine switch is in ACC or ON.

When “Bluetooth Power” is off:

The Bluetooth® device is disconnected, and the system will not connect to it next time.

- While driving, the auto connection state can be changed from off to on, but cannot be changed from on to off.

### Setting automatic connection priority

The automatic connection priority of the registered Bluetooth® devices can be changed.

- 1 Select “Preferred Device Settings”.
- 2 Select the desired item to be set.



- A** Select to set automatic connection priority on/off.
- B** Select to change the automatic connection priority of the registered Bluetooth® phones. (→P.46)
- C** Select to change the automatic connection priority of the registered Bluetooth® audio players. (→P.46)
- D** Select to reset all setup items.

### Changing Bluetooth® device automatic connection priority

- 1 Select “Preferred Phones” or “Preferred Audio Players”.

- 2 Select the desired Bluetooth® device and select “Move Up” or “Move Down” to change the preferred order.



- A newly registered Bluetooth® device will automatically be given the highest automatic connection priority.

### Editing the system information

- 1 Select “System Information”.
- 2 Select the desired item to be set.



- A** Displays system name. Can

be changed to a desired name. (→P.47)

- B** PIN code used when the Bluetooth® device was registered. Can be changed to a desired code. (→P.47)
- C** Device address is unique to the device and cannot be changed.
- D** Select to set the connection status display of the phone on/off.
- E** Select to set the connection status display of the audio player on/off.
- F** Compatibility profile of the system
- G** Select to reset all setup items.

#### ■ Editing the system name

- 1 Select "System Name".
- 2 Enter a name and select "OK".

#### ■ Editing the PIN code

- 1 Select "System PIN Code".
- 2 Enter a PIN code and select "OK".

## Wi-Fi® hotspot\*

\*: Vehicles equipped with DCM only. This function is not made available in some countries or areas.

### By connecting a device to the vehicle via Wi-Fi®, it can access the internet through the DCM.

- To use this function, a Wi-Fi® hotspot service subscription from AT&T is required. Connect your device to the in-vehicle access point (see instructions below), or contact the Customer Experience Center at 1-800-331-4331 for assistance.

### Connecting a device to the in-vehicle access point

#### Searching for and connecting a device to the vehicle access point

- 1 Enable the Wi-Fi® hotspot function. (→P.49)
  - 2 Disable the "Hide Access Point" function. (→P.49)
  - 3 Search for the vehicle access point using the device you wish to connect.
- For details about operating the device, refer to the docu-

mentation which came with it.

- 4 Operate the device to connect it to the vehicle access point.
    - To check the vehicle access point password, check “Password”. (→P.49)
- 
- Hints for connecting to the vehicle via Wi-Fi® can be displayed. (→P.49)

### Connecting a device to the in-vehicle access point using the access point name (SSID)

- 1 Enable the Wi-Fi® hotspot function. (→P.49)
- 2 Enable the “Hide Access Point” function. (→P.49)
- 3 Enter the access point name (SSID) into the device you wish to connect and connect it.
  - To check the vehicle access point password, check “Password”. (→P.49)
  - The security settings on the device must be the same as that displayed for “Security”. (→P.49)
  - For details about operating the device, refer to the documentation which came with it.

## Changing the Wi-Fi® settings

- 1 Press the “MENU” button.

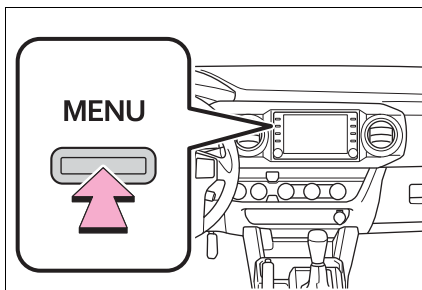

- 2 Select “Setup”.
  - 3 Select “Wi-Fi\*”.
- \*: Wi-Fi® is a registered trademark of Wi-Fi Alliance®.
- 4 Select the desired item to be set.

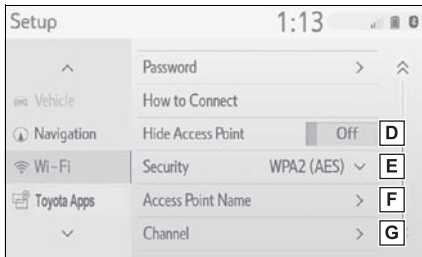
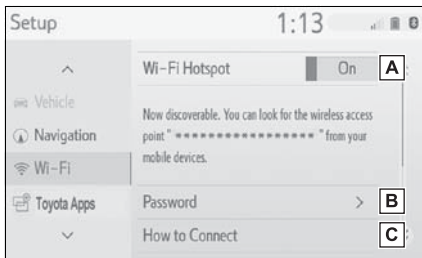

- A Select to enable/disable the Wi-Fi® hotspot function. (→P.49)



- B** Select to check/change the access point password. (→P.50)
- C** Select to display hints for connecting to the vehicle via Wi-Fi®.
- D** Select to make the access point searchable/unsearchable.
- E** Select to check/change the security protocol of the access point (for authentication and encryption). (→P.50)
- F** Select to change the access point name (SSID). (→P.50)
- G** Select to change the Wi-Fi® connection channel (within the 2.4GHz frequency band). (→P.51)

- If any settings have been changed, it will be necessary to reset the Wi-Fi® system to complete the changes. To reset the Wi-Fi® system, select “Yes” on the pop-up displayed after changing the settings.

### Enabling/disabling the Wi-Fi® hotspot function

When the Wi-Fi® hotspot function is enabled, the system checks for a valid hotspot service subscription.

If a hotspot service subscription has not been started, connect your device to the in-vehicle

access point to start your subscription. A trial subscription may be available.

Contact your Toyota dealer for details about the Toyota mobile application.

### Checking/changing the password

- 1 Select “Password”.
- 2 Check that the following screen is displayed.

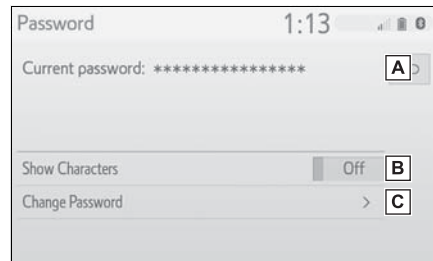

- A** Displays the password
- B** Select to display/hide the entered password.
- C** Select to change the password.

### Changing the password

- 1 Select “Change Password”.
  - 2 Enter the desired password and select “OK”.
- When setting/changing a password, observe the following guidelines to help prevent the password from being cracked by a third party:
    - Use an 8-character or longer

password consisting of letters and numbers. (Non-ASCII characters will not be recognized by the system.)

- Change the password regularly.
- If you write the password down, do not leave it somewhere where it would be visible.
- Do not use the same password for vehicle Wi-Fi® hotspot as other accounts already protected by a password.
- Avoid using easy to identify words, such as your vehicle's model name or license plate number, simple dictionary words, or words with simple obfuscation, such as c@t (for cat), as your password.

### Changing the security protocol

- 1 Select "Security".
- 2 Select the desired security protocol.

### Changing the access point name (SSID)

- 1 Select "Access Point Name".
- 2 Enter the desired access point name (SSID) and select "OK".

### Selecting a Wi-Fi® connection channel

- 1 Select "Channel".

- 2 Check that the following screen is displayed.

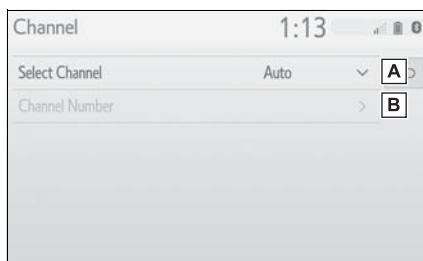

- A Select to change the channel selection to auto/manual.
- B When "Manual" is selected, select to change the channel.

### Changing the channel

- 1 Set "Select Channel" to "Manual".
  - 2 Select "Channel Number".
  - 3 Enter the desired channel number and select "OK".
- Channels 1 through 11 can be selected.

### Wi-Fi® function operating hints

- If a connected device is taken out of the Wi-Fi® connection area, the connection will be severed.
- If the vehicle is driven out of the cellular communication coverage area, connecting to the internet via the Wi-Fi® hotspot will not be possible.
- If a Bluetooth® device is used while a device is connected using

the Wi-Fi<sup>®</sup> hotspot function, the communication speed may decrease.

- If the vehicle is near a radio antenna, radio station or other source of strong radio waves and electrical noise, communication may be slow or impossible.



### WARNING

- Use Wi-Fi<sup>®</sup> devices only when safe and legal to do so.
- Your audio unit is fitted with Wi-Fi<sup>®</sup> antennas. People with implantable cardiac pacemakers, cardiac resynchronization therapy-pacemakers or implantable cardioverter defibrillators should maintain a reasonable distance between themselves and the Wi-Fi<sup>®</sup> antennas. The radio waves may affect the operation of such devices.
- Before using Wi-Fi<sup>®</sup> devices, users of any electrical medical device other than implantable cardiac pacemakers, cardiac resynchronization therapy-pacemakers or implantable cardioverter defibrillators should consult the manufacturer of the device for information about its operation under the influence of radio waves. Radio waves could have unexpected effects on the operation of such medical devices.

### Conditions displayed with Wi-Fi<sup>®</sup> icon

The condition of Wi-Fi<sup>®</sup> connection appears on the right upper side of the screen. (→P.16)

### Specifications

- Communication standards
  - IEEE 802.11b
  - IEEE 802.11g
  - IEEE 802.11n (2.4GHz)
- Security
  - WPA<sup>™</sup>
  - WPA2<sup>™</sup>
- WPA<sup>™</sup> and WPA2<sup>™</sup> are trademarks of Wi-Fi Alliance<sup>®</sup>.

## Apple CarPlay/Android Auto\*

\*: This function is not made available in some countries or areas

**Apple CarPlay/Android Auto allows some applications, such as Map, Phone, and Music, to be used on the system.**

**When an Apple CarPlay/Android Auto connection is established, Apple CarPlay/Android Auto compatible applications will be displayed on the system display.**

- Compatible device

Apple iPhone (iOS Ver. 9.3 or later) that supports Apple CarPlay.

For details, refer to <https://www.apple.com/ios/carplay/>.

Android devices with Android OS Ver. 5.0 or higher which support Android Auto and have the Android Auto application installed.

For details, refer to <https://www.android.com/auto/>.

## Establishing an Apple CarPlay connection

**1** Enable Siri on the device to be connected.

- 2** Connect the device to the USB port. (→P.122)
- 3** Select “Always Enable” or “Enable Once”.



- “Do Not Enable”: Select to not enable Apple CarPlay. Apple CarPlay will remain off until “Apple CarPlay” of “Projection Settings” on the general settings screen is turned on.
  - Depending on the device connected, it may take approximately 3 to 6 seconds before the system returns to previous screen.
  - The screen may change to step 6 depending on the system.
- 4** Press the “MENU” button.

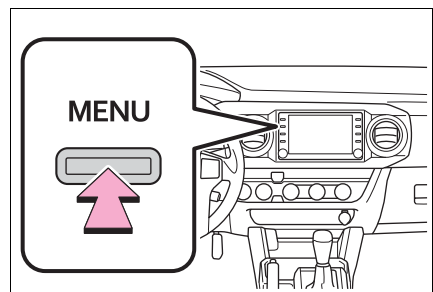

### 5 Select the “Apple CarPlay”.



### 6 Check that home screen of Apple CarPlay is displayed.

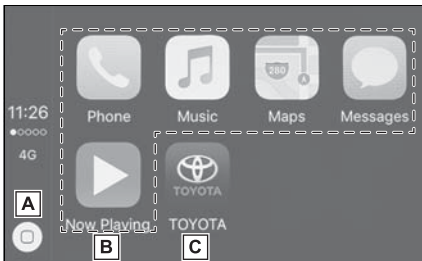

- A** Select to display the home screen of Apple CarPlay. Select and hold to activate Siri.
- B** Select to start the application. User can use any iPhone application supported by Apple CarPlay.
- C** Select to display the system screen.

## Establishing an Android Auto connection

- 1 Check that the Android Auto application is installed to the device to be connected.
- 2 Connect the device to the USB port. (→P.122)

### 3 Select “On” to enable the function.

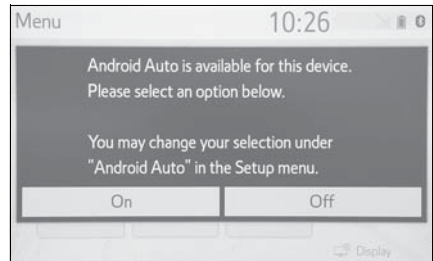

- “Off”: Select to not enable Android Auto. Android Auto will remain off until “Android Auto” of “Projection Settings” on the general settings screen is turned on.
  - Depending on the device connected, it may take approximately 3 to 6 seconds before the system returns to previous screen.
  - The screen may change to step 6 depending on the system.
- 4 Press the “MENU” button.

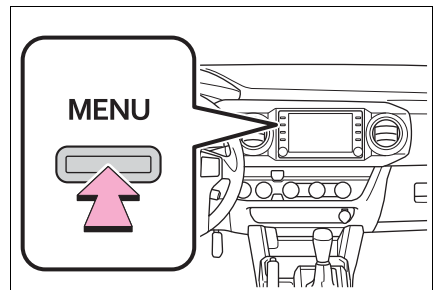

### 5 Select the “Android Auto”.



### 6 Check that home screen of Android Auto is displayed.

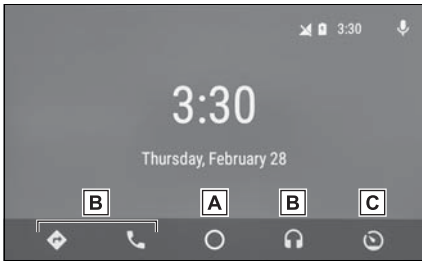

**A** Select to display the home screen of Android Auto.

**B** Select to start the application.  
User can use any Android application supported by Android Auto.

**C** Select to display the system screen.

● When an Apple CarPlay/Android Auto connection is established, the function of some system buttons will change.

● When an Apple CarPlay/Android Auto connection is established, some system functions, such as the following, will be replaced by similar Apple CarPlay/Android Auto functions or will become unavailable:

- iPod (Audio Playback)
- USB audio/USB video
- Bluetooth® audio

- Bluetooth® phone (Apple CarPlay only)
- Toyota apps

● The guidance volume can be changed on the voice settings screen. (→P.64)

● Apple CarPlay/Android Auto is an application developed by Apple Inc/Google LLC. Its functions and services may be terminated or changed without notice depending on the connected device's operation system, hardware and software, or due to changes in Apple CarPlay/Android Auto specifications.

● For a list of the apps supported by Apple CarPlay or Android Auto, refer to their respective website.

● While using these functions, vehicle and user information, such as location and vehicle speed, will be shared with the respective application publisher and the cellular service provider.

● By downloading and using each application, you agree to their terms of use.

● Data for these functions is transmitted using the internet and may incur charges. For information about data transmission fees, contact your cellular service provider.

● Depending on the application, certain functions, such as music playback, may be restricted.

● As the applications for each function are provided by a third-party, they may be subject to change or discontinuation without notice. For details, refer to the website of the function.

● If the vehicle's navigation system is being used for route guidance and a route is set using the Apple CarPlay/Android Auto Maps app, route guidance will be performed through Apple CarPlay/Android Auto. If the Apple CarPlay/Android Auto Maps app is being used for

route guidance and a route is set using the vehicle's navigation system, route guidance will be performed by the vehicle's navigation system.

- If the USB cable is disconnected, operation of Apple CarPlay/Android Auto will end. At this time, sound output will stop and change to the system screen.



- Use of the Apple CarPlay logo means that a vehicle user interface meets Apple performance standards. Apple is not responsible for the operation of this vehicle or its compliance with safety and regulatory standards. Please note that the use of this product with iPhone, iPod, or iPad may affect wireless performance.
- CarPlay, iPhone, iPod, iPod nano, iPod touch, and Lightning are trademarks of Apple Inc., registered in the U.S. and other countries. Apple CarPlay is a trademark of Apple Inc.

android  
auto

- Android and Android Auto are trademarks of Google LLC.

#### WARNING

- Do not connect smartphone or operate the controls while driving.

#### NOTICE

- Do not leave your smartphone in the vehicle. In particular, high temperatures inside the vehicle may damage the smartphone.
- Do not push down on or apply unnecessary pressure to the smartphone while it is connected as this may damage the smartphone or its terminal.
- Do not insert foreign objects into the port as this may damage the smartphone or its terminal.

## Troubleshooting

If you are experiencing difficulties with Apple CarPlay/Android Auto, check the following table.

Symptom	Solution
An Apple Car-Play/Android Auto connection cannot be established.	<p>Check if the device supports Apple CarPlay/Android Auto.</p> <p>Check if Apple CarPlay/Android Auto is enabled on the connected device.</p> <p>Check if that the Android Auto application is installed to the device to be connected.</p> <p>For details, refer to <a href="https://www.apple.com/ios/carplay/">https://www.apple.com/ios/carplay/</a>, <a href="https://www.android.com/auto/">https://www.android.com/auto/</a>.</p>
	Check if “Apple CarPlay”/“Android Auto” of “Projection Settings” on the general settings screen is set to on. (→P.60)
	<p>Check if the USB cable being used is securely connected to the device and USB port.</p> <p>Try connecting the smartphone directly to the USB port in the vehicle, without using the hub.</p> <p>For Apple CarPlay: Check if the Lightning cable being used is certified by Apple and check if Siri is enabled.</p>
	After checking all of the above, try to establish an Apple CarPlay/Android Auto connection. (→P.53)
When an Apple Car-Play/Android Auto connection is established and a video is being played, the video is not displayed, but audio is output through the system.	As the system is not designed to play video through Apple CarPlay/Android Auto, this is not a malfunction.
Although an Apple Car-Play/Android Auto connection is established, audio is not output through the system.	The system may muted or the volume may be low. Increase the system volume.



Symptom	Solution
<p>The Apple CarPlay/Android Auto screen has artifacts and/or audio from Apple CarPlay/Android Auto has noise.</p>	<p>Check if the USB cable being used to connect the device to the system is damaged. To check if the USB cable is damaged internally, connect the device to another system, such as a PC, and check if the device is recognized by the connected system. (The device should begin charging when connected.)</p> <p>After checking all of the above, try to establish an Apple CarPlay/Android Auto connection. (→P.53)</p>
<p>The map display of the Apple CarPlay Maps app cannot be enlarged or contracted with pinch multi-touch gestures.</p>	<p>As the Apple CarPlay Maps app is not compatible with pinch multi-touch gestures, this is not a malfunction.</p>
<p>During Apple CarPlay music application (Apple Music, Spotify, etc.) playback, if the iPhone is operated to start and play audio from an application that is not compatible with Apple CarPlay* and the onboard device volume is changed, the audio of the incompatible application stops and the system resumes playback of the original music application.</p>	<p>This operation is performed according to the specification of the onboard device, this is not a malfunction.</p>
<p>After interrupt audio (such as navigation route guidance) is played from an application that is not compatible with Apple CarPlay while the onboard device is playing audio (FM/AM, CD, etc.), the system does not resume playback of the original audio (FM/AM, CD, etc.).</p>	<p>This operation is performed according to the specification of the onboard device, this is not a malfunction. Manually change the audio source by yourself. Or, do not use applications that are not compatible with Apple CarPlay.* Due to some navigation applications are compatible from iOS 12, update to the latest iOS and application versions.</p>

Symptom	Solution
<p>When using Apple CarPlay, route guidance arrows and turn by turn navigation are not displayed on the multi-information display and system display. When using Android Auto, turn by turn navigation is not displayed on the multi-information display and system display.</p>	<p>This is not a malfunction as display of these items is not possible with this function.</p>
<p>When using Android Auto, hands-free call audio cannot be heard from the vehicle's speakers.</p>	<p>Disconnect the phone from the USB cable and check if hands-free call audio can be heard using the hands-free system.</p> <hr/> <p>Connect the phone to the system using Android Auto, turn up the volume on the system and check if hands-free call audio can be heard. Check if other sounds can be heard from the vehicle's speakers.</p>

\*: Applications not compatible with Apple CarPlay are applications installed on the iPhone that are not displayed on the Apple CarPlay screen application list. (such as visual voicemail)

## General settings

Settings are available for clock, operation sounds, etc.

### Displaying the general settings screen

- 1 Press the “MENU” button.

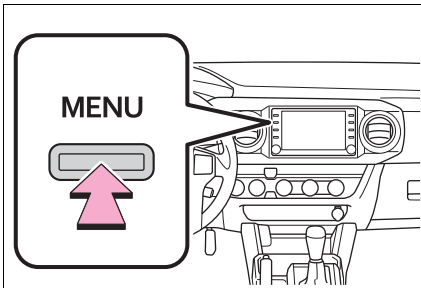

- 2 Select “Setup”.

- If the general settings screen is not displayed, select “General”.

- 3 Select the desired items to be set.

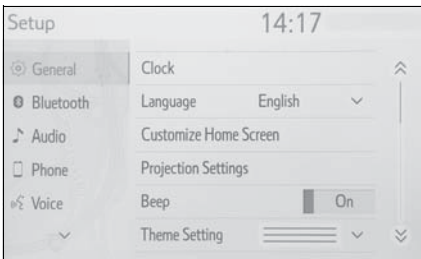

### General settings screen

- “Clock”

Select to change the time zone and select “On” or “Off” or “Auto”<sup>\*1</sup> for

daylight saving time, automatic adjustment of the clock, etc. (→P.61)

- “Language”

Select to change the language. The language setting of Apple CarPlay/Android Auto can only be changed on the connected device.

- “Customize Home Screen”

Select to change the display information/area on the home screen and the home screen layout. (→P.29)

- “Projection Settings”<sup>\*2</sup>

Select to set automatic Apple CarPlay/Android Auto connection establishment on/off. (→P.62)

- “Beep”

Select to turn the beep sound on/off.

- “Theme Setting”

Select to change the screen theme setting.

- “Unit of Temperature”<sup>\*1</sup>

Select to change the unit of temperature.

- “Units of Measurement”

Select to change the unit of measurement for distance/fuel consumption.

- “Auto Change to Screen”<sup>\*1</sup>

Select to set automatic screen changes from the audio control screen to the home screen to on/off. When set to on, the screen will automatically return to the home screen from the audio control screen after 20 seconds.

- “Keyboard Layout”

Select to change the keyboard layout.

- “Delete Keyboard History”

Select to delete the keyboard history.

- “Memorize Keyboard History”

Select to set the memorize keyboard history on/off.

- “Animation”

Select to turn the animations on/off.

- “Driver Setting”

Select to change the driver settings. (→P.62)

- “Delete Personal Data”

Select to delete personal data. (→P.63)

- “Software Update”

Select to update software versions. For details, contact your Toyota dealer.

- “Software Update Setting”<sup>\*2, 3</sup>

Select to set software update setting. (→P.63)

- “Gracenote Database Update”

Select to update Gracenote® database versions. For details, contact your Toyota dealer.

- “Software Information”

Select to display the software information. Notices related to third party software used in this product are enlisted. (This includes instructions for obtaining such software, where applicable.)

- “SW Sensitivity Level”

Select to change the capacitive

touch screen button sensitivity to 1 (low), 2 (medium), or 3 (high).

\*1: Premium Audio only

\*2: This function is not made available in some countries or areas.

\*3: Vehicles equipped with DCM

## Clock settings

- 1 Display the general settings screen. (→P.60)
- 2 Select “Clock”.
- 3 Select the desired items to be set.

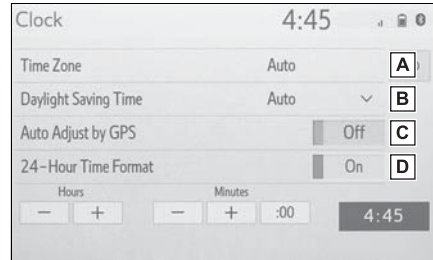

- A** Select to change the time zone. (→P.62)
- B** Select to set daylight saving time on/off/auto\*.
- C** Select to set automatic adjustment of the clock by GPS on/off. When set to off, the clock can be manually adjusted. (→P.62)
- D** Select to set the 24 hour time format on/off. When set to off, the clock is displayed in 12 hour time format.

\*: Premium Audio only

### Setting the time zone

- 1 Select "Time Zone".
  - 2 Select the desired time zone.
- Premium Audio only:  
If "Auto" is selected, the time zone is selected automatically by current vehicle position.

### Manual clock setting

When "Auto Adjust by GPS" is turned off, the clock can be manually adjusted.

- 1 Select "Auto Adjust by GPS" to set to off.
- 2 Adjust the clock manually.

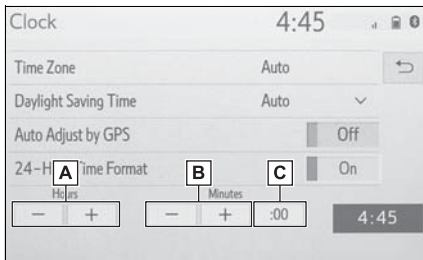

- A** Select "+" to set the time forward one hour and "-" to set the time back one hour.
- B** Select "+" to set the time forward one minute and "-" to set the time back one minute.
- C** Select to round to the nearest hour.  
e.g.  
1:00 to 1:29 → 1:00  
1:30 to 1:59 → 2:00

### Projection settings\*

- \*: This function is not made available in some countries or areas.
- 1 Display the general settings screen. (→P.60)
  - 2 Select "Projection Settings".
  - 3 Select the desired items to be set.

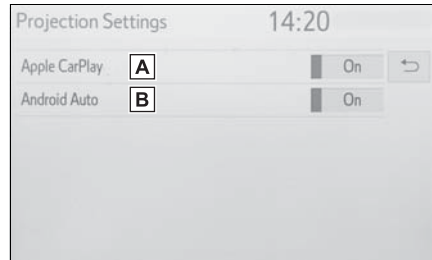

- A** Select to turn Apple CarPlay connection establishment on/off.
- B** Select to turn Android Auto connection establishment on/off.

- When the settings are changed with a device connected to the system via USB, disconnect the device and connect it again to enable the settings.

### Driver settings

The driver settings feature will allow the system to link some preferences (such as audio presets, screen theme, language, etc.) to a paired Bluetooth® phone.

- 1 Display the general settings screen. (→P.60)

- 2 Select “Driver Setting”.
- 3 Select “Enable This Feature”.

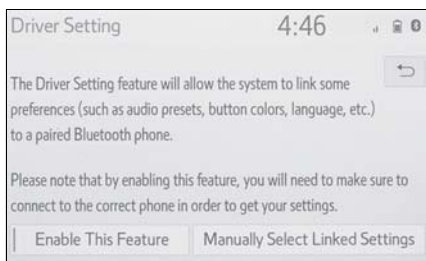

### Manually select linked settings

- 1 Select “Manually Select Linked Settings”.
- 2 Select the desired phone.

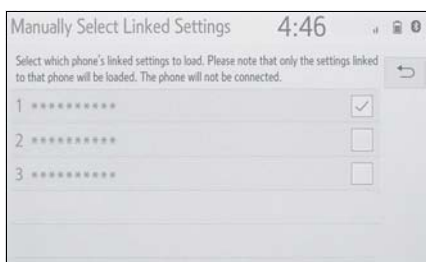

- After a few seconds, loaded screen automatically switches to the home screen.

### Deleting personal data

Registered or changed personal settings will be deleted or returned to their default conditions.

- 1 Display the general settings screen. (→P.60)
- 2 Select “Delete Personal Data”.
- 3 Select “Delete”.

- 4 Select “Yes” when the confirmation screen appears.

Examples of settings that can be returned to their default conditions:

- Navigation settings\*
- Audio settings
- Phone settings

etc.

\*: Premium Audio only

### Software update settings\*

\*: Vehicles equipped with DCM only. This function is not made available in some countries or areas.

When the automatic update check function is enabled, if a software update is available from the Cloud, a message will be displayed.

- 1 Display the general settings screen. (→P.60)
- 2 Select “Software Update Setting”.
- 3 Select “Automatic Update Check” to enable/disable the automatic update check function.

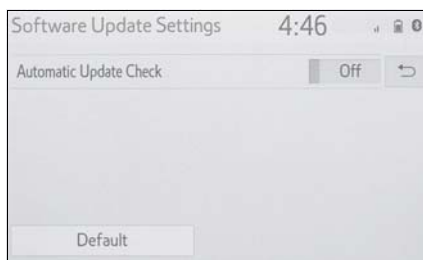

- When software update information

is displayed, contact your Toyota dealer.

## Voice settings

Voice volume, etc. can be set.

### Displaying the voice settings screen

- 1 Press the “MENU” button.

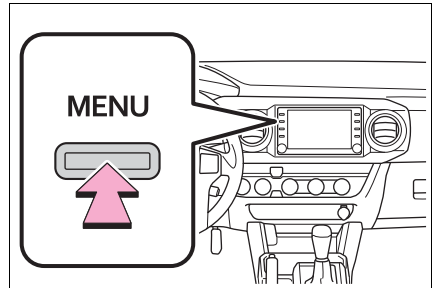

- 2 Select “Setup”.
- 3 Select “Voice”.
- 4 Select the desired items to be set.

### Voice settings screen

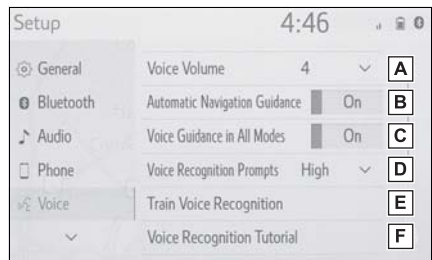

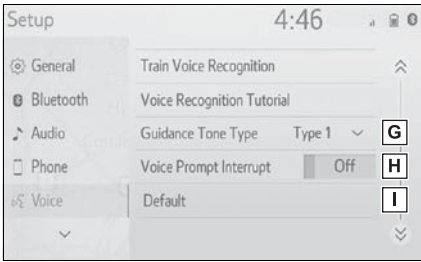

- A** Select to adjust the volume of voice guidance.
- B** Select to set the voice guidance during route guidance on/off.\*
- C** Select to set the voice guidance during audio/visual system use on/off.\*
- D** Select to set the voice recognition prompts.
- E** Select to train voice recognition. The voice command system adapts the user accent.
- F** Select to start the voice recognition tutorial.
- G** Select to set the beep sound of navigation guidance.\*
- H** Select to set the voice prompt interrupt on/off.
- I** Select to reset all setup items.

\*: Premium Audio only

## Vehicle settings

Settings are available for maintenance, vehicle customization, etc.

### Displaying the vehicle settings screen

- 1 Press the "MENU" button.

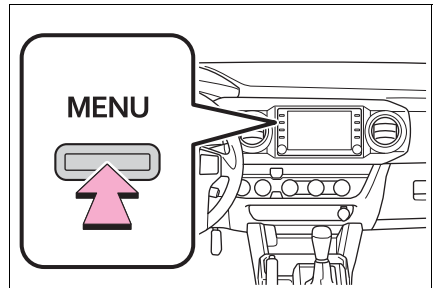

- 2 Select "Setup".
- 3 Select "Vehicle".
- 4 Select the desired items to be set.

### Vehicle settings screen

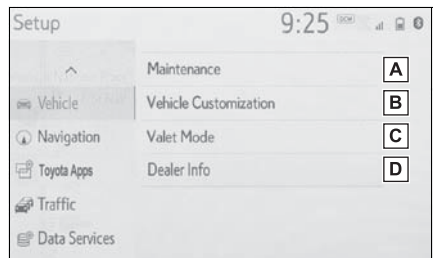

- A** Select to set maintenance.\*1 (→P.66)
- B** Select to set vehicle customization.\*2



- C** Select to set valet mode.  
(→P.68)
- D** Select to set dealer information.\*3, 4

\*1: Premium Audio only

\*2: Refer to the “OWNER’S MANUAL”

\*3: If equipped

\*4: This function is not made available in some countries or areas.

## Maintenance\*

\*: Premium Audio only

When the system is turned on, the maintenance reminder screen displays when it is time to replace a part or certain components. (→P.26)

- 1 Display the vehicle settings screen. (→P.65)
- 2 Select “Maintenance”.
- 3 Select the desired item.

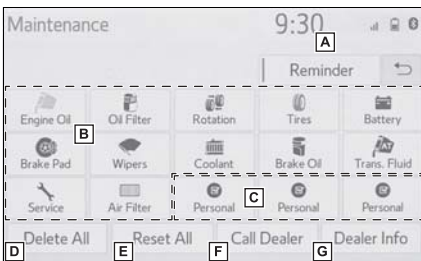

- A** The system is set to give maintenance information with the maintenance reminder screen. (→P.26)
- B** Select to set a reminder for a part or component. (→P.66)

- C** Select to add a reminder other than the provided ones.
- D** Select to cancel all reminders which have been entered.
- E** Select to reset all reminders which have expired.
- F** Select to call the registered dealer.
- G** Select to register/edit dealer information. (→P.67)

- When the vehicle needs to be serviced, the screen button color will change to orange.

## Maintenance information setting

- 1 Select the desired part or component screen button.
- 2 Set the conditions.

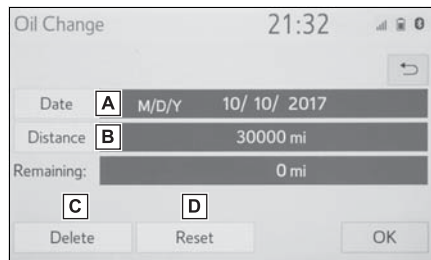

- A** Select to enter the next maintenance date.
- B** Select to enter the driving distance until the next maintenance check.
- C** Select to cancel the conditions which have been entered.

- D** Select to reset the conditions which have expired.
- 3** Select “OK” after entering the conditions.

- For scheduled maintenance information, refer to “Scheduled Maintenance Guide” or “Owner’s Manual Supplement”.
- Depending on driving or road conditions, the actual date and distance that maintenance should be performed may differ from the stored date and distance in the system.

### Dealer setting

Dealer information can be registered in the system. With dealer information registered, route guidance to the dealer is available.

- 1** Select “Set Dealer”.
  - 2** Select the desired item to search for the location. (→P.84)
- The editing dealer screen appears after setting the location.
- 3** Select the desired items to be edited.

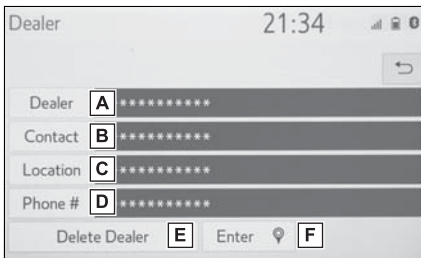

- A** Select to enter the name of a

dealer. (→P.67)

- B** Select to enter the name of a dealer member. (→P.67)
- C** Select to set the location. (→P.67)
- D** Select to enter the phone number. (→P.68)
- E** Select to delete the dealer information displayed on the screen.
- F** Select to set the displayed dealer as a destination. (→P.91)

### Editing dealer or contact name

- 1** Select “Dealer” or “Contact”.
- 2** Enter the name and select “OK”.

### Editing the location

- 1** Select “Location”.
- 2** Scroll the map to the desired point (→P.75) and select “Enter”.

### Editing phone number

- 1** Select “Phone #”.
- 2** Enter the phone number and select “OK”.

### Setting the valet mode

The security system can be set

to on by entering a security code (4-digit number).

When set to on, the system will become inoperative once the electrical power source is disconnected until the security code is entered.

- 1 Display the vehicle settings screen. (→P.65)
  - 2 Select “Valet Mode”.
  - 3 Enter the 4-digit personal code and select “OK”.
  - 4 Enter the same 4-digit personal code again and select “OK”.
- The system will request that you input the security code again to confirm that you remember it correctly.
  - When valet mode activates, the system stops and a security code (4-digit number) standby screen is displayed.

- If the 4-digit personal code is forgotten, please contact your Toyota dealer.

### If the valet mode has been activated

- 1 Enter the 4-digit personal code and select “OK”.
- If an incorrect security code (4-digit number) is entered 6 times, the system will not accept another security code (4-digit number) for 10 minutes.

## Setting dealer information\*

\*: If equipped

Dealer information can be registered in the system. If the vehicle alert screen is displayed, selecting the call dealer button on the screen will call the phone number registered in the dealer information.

- 1 Display the vehicle settings screen. (→P.65)
- 2 Select “Dealer Info”.
- 3 Select the desired items to be edited.

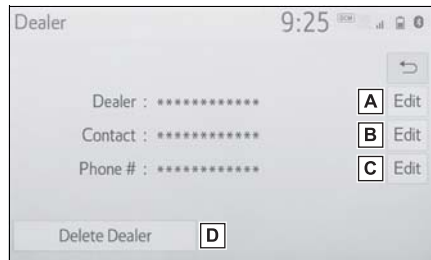

- A Select to enter the name of a dealer. (→P.69)
- B Select to enter the name of a dealer member. (→P.69)
- C Select to enter the phone number. (→P.69)
- D Select to delete the dealer information displayed on the screen.

**Editing dealer or contact name**

- 1 Select “Edit” next to “Dealer” or “Contact”.
- 2 Enter the name and select “OK”.

**Editing phone number**

- 1 Select “Edit” next to “Phone #”.
- 2 Enter the phone number and select “OK”.

**3-1. Basic operation**

Navigation .....	72
Map screen operation ....	74
Map screen information .	76
Traffic information .....	81

**3-2. Destination search**

Destination search operation .....	84
Starting route guidance..	91

**3-3. Route guidance**

Route guidance screen ..	95
Typical voice guidance prompts .....	99
Editing route .....	99

**3-4. Setup**

Navigation settings.....	102
Detailed navigation settings .....	106
Traffic settings .....	109
Use of information accumulated by navigation system .....	113

**3-5. Tips for operating the navigation system**

GPS (Global Positioning System) .....	114
Map database version and covered area .....	116

## Navigation\*

\*: Premium Audio only

The navigation system indicates your present position and assists in locating a desired destination. To display the map screen, press the “MAP” button.

### Map screen overview

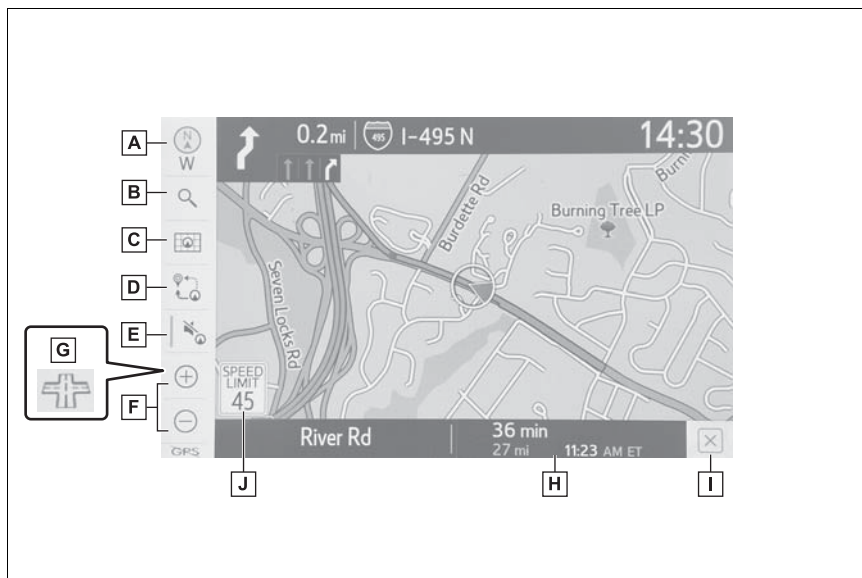

- A** 2D north up, 2D heading up or 3D heading up symbol (→P.75)  
Indicates whether the map orientation is set to north-up or heading-up. The letter(s) under this symbol indicate the vehicle's heading direction (e.g. N for north). In 3D map, only a heading-up view is available.
- B** Destination button (→P.84)  
Select to display the destination screen.
- C** Map options button (→P.76)  
Select to display the map options screen.
- D** Route options button (→P.99)  
Select to display the route options screen.
- E** Mute button

Select to mute the voice guidance. When set to on, the indicator will illuminate.

**F** Zoom in/out button (→P.74)

Select to magnify or reduce the map scale. When either button is selected, the map scale indicator bar appears at the bottom of the screen.

**G** Micro city map button (→P.74)

Select to display the micro city map screen.

**H** Route information bar (→P.95)

Displays the distance with the estimated travel time/arrival time to the destination. The route information bar fills from left to right as the vehicle progresses on the route.

**I** Delete destination button (→P.22)

Select to delete destinations.

**J** Speed limit icon (→P.76)

Indicates the speed limit on the current road. The display of the speed limit icon can be set to on/off.

- 
- When the vehicle is not receiving GPS signals, such as when driving in a tunnel,  will be displayed at the bottom left corner of the screen.
  - Press the “MAP” button to display the address of the current position on the map screen or repeat voice guidance.

## Map screen operation

### Current position display

- 1 Press the "MAP" button.

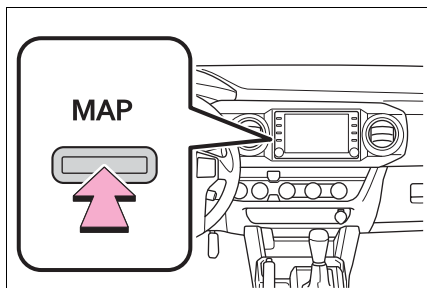

- 2 Check that the current position map is displayed.

- To correct the current position manually: →P.108
- While driving, the current position mark is fixed on the screen and the map moves.
- The current position is automatically set as the vehicle receives signals from the GPS (Global Positioning System). If the current position is not correct, it is automatically corrected after the vehicle receives signals from the GPS.
- After the 12-volt battery disconnection, or on a new vehicle, the current position may not be correct. As soon as the navigation system receives signals from the GPS, the correct current position is displayed.

### Map scale

- 1 Select  $\oplus$  or  $\ominus$  to change the scale of the map screen.

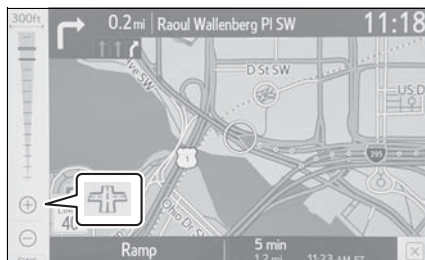

- The scale indicator bar appears at the bottom of the screen.
- Select and hold  $\oplus$  or  $\ominus$  to continue changing the scale of the map screen.
- The scale of the map screen can also be changed by selecting the scale bar directly. This function is not available while driving.
- Pinch outward on the screen to zoom in and pinch inward to zoom out.
- In areas where a micro city map is available,  $\oplus$  will change to  $\oplus$  when the map screen is set to the smallest scale.

### Micro city map

For areas covered by the micro city map (some major cities), a micro city map on a scale of 75 ft. (25 m) can be selected.

When the map is scaled down to 150 ft. (50 m),  $\oplus$  changes to





and can be selected to display the micro city map.



- 1 Select  on the map screen.
- 2 Check that the micro city map is displayed.



- To return to the normal map display, select .
- If the map or the current position is moved to the area which is not covered by the micro city map, the screen scale automatically changes to 150 ft. (50 m).
- On the micro city map, a one way street is displayed by .
- Scrolling the micro city map is not available while driving.
- Certification

Building micro cities in the database were created and provided by HERE.

### Orientation of the map

The orientation of the map can be changed between 2D north-up, 2D heading-up and 3D heading-up by selecting the orientation symbol displayed at the top left of the screen.

 : North-up symbol

Regardless of the direction of vehicle travel, north is always

up.

 : Heading-up symbol

The direction of vehicle travel is always up.

 : 3D Heading-up symbol

The direction of vehicle travel is always up.

- The letter(s) under this symbol indicate the vehicle's heading direction (e.g. N for north).

### Map scroll operation

The map can be scrolled to view locations that are different than your current position.

- 1 Select the desired point on the map screen.
- Move the desired point on the center of the map screen.

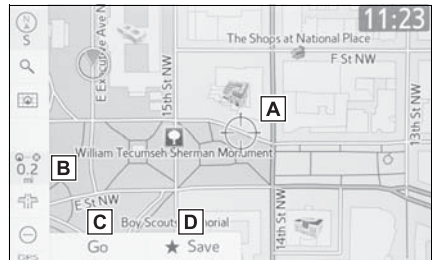

- A** Cursor mark
- B** Distance from the current position to the cursor mark
- C** Select to set as a destination. (→P.91)
- D** Select to register as a memory point. To change the icon, name, etc.: →P.102

- The map screen can be scrolled by touching, dragging or flicking it. (→P.27)
- Press the “MAP” button to return to the current position.

## Map screen information

Information such as POI icons, route trace, speed limit, etc. can be displayed on the map screen.

## Displaying the map options screen

- 1 Select  on the map screen. (→P.72)
- 2 Select the desired items to be displayed.

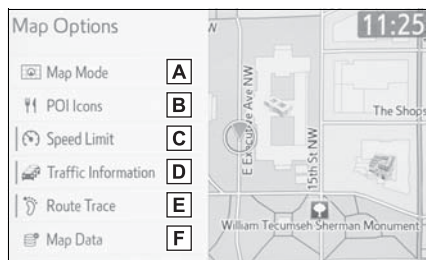

- A Select to display the desired map mode. (→P.77)
- B Select to select or change POI icons. (→P.77)
- C Select to display speed limit icon.
- D Select to display traffic information. \* (→P.81)
- E Select to display route trace. (→P.79)
- F Select to display the map version and coverage area.

(→P.116)

\*: This function is not made available in some countries or areas.

### Switching the map mode

- 1 Select  on the map screen. (→P.72)
- 2 Select “Map Mode”.
- 3 Select the desired configuration button.

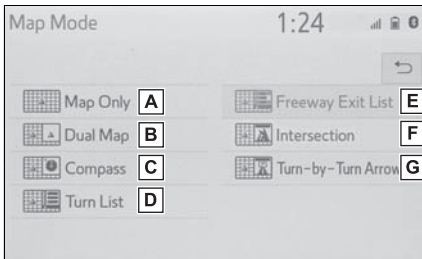

- A** Select to display the single map screen.
- B** Select to display the dual map screen. (→P.77)
- C** Select to display the compass mode screen. (→P.78)
- D** Select to display the turn list screen. (→P.98)
- E** Select to display the freeway exit list screen. (→P.96)
- F** Select to display the intersection guidance screen or the guidance screen on the freeway. (→P.97)
- G** Select to display the turn-by-turn arrow screen. (→P.98)

- Depending on the conditions, certain screen configuration buttons cannot be selected.

### Dual map

The map on the left is the main map. The right side map can be edited.

- 1 Select any point on the right side map.



- 2 Select the desired item.

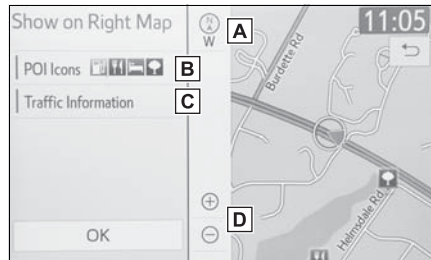

- A** Select to change the orientation of the map. (→P.75)
- B** Select to display POI icons. (→P.78)
- C** Select to show traffic information.\* (→P.81)
- D** Select to change the map scale. (→P.74)

\*: This function is not made available in some countries or areas.

### 3 Select “OK”.

#### Compass

Information about the destination, current position and a compass are displayed on the screen.

- The destination mark is displayed in the direction of the destination. When driving, refer to the longitude and latitude coordinates, and the compass, to make sure that the vehicle is headed in the direction of the destination.
- When the vehicle travels out of the coverage area, the guidance screen changes to the whole compass mode screen.

#### Selecting the POI icons

- 1 Select  on the map screen. (→P.72)
- 2 Select “POI Icons”.
- 3 Select the desired POI category and select “OK”.

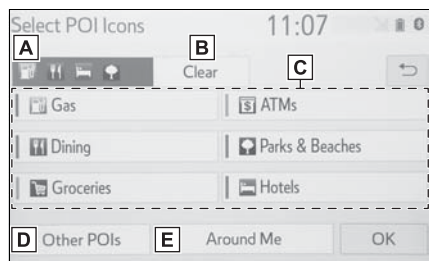

- A** Displays up to 5 selected POI icons on the map screen.
- B** Select to cancel the selected POI icons.

- C** Displays up to 6 POI icons as favorite POI categories. (→P.107) If a POI category is selected to be displayed on the map, its icon will be displayed above.
- D** Select to display other POI categories if the desired POIs cannot be found on the screen.
- E** Select to search for the nearest POIs. (→P.78)

#### Selecting other POI icons to be displayed

- 1 Select “Other POIs”.
- 2 Select the desired POI categories and select “OK”.

“List All Categories”: Select to display all POI categories.

#### Displaying the local POI list

POIs that are within 20 miles (32 km) of the current position will be listed from among the selected categories.

- 1 Select “Around Me”.
- 2 Select the desired POI.

“Sort/Search Area”: Select to sort (distance, name, category) POIs or search area.

- Select “Near Here” to search for POIs near the current position.
- Select “Along My Route” to

search for POIs along the route.

- 3 Check that the selected POI is displayed on the map screen.

### Route trace

The traveled route can be stored and retraced on the map screen. This feature is available when the map scale is 30 miles (50 km) or less.

#### Start recording the route trace

- 1 Select  on the map screen. (→P.72)
- 2 Select “Route Trace”.
- The route trace starts.
- 3 Check that the traveled line is displayed.

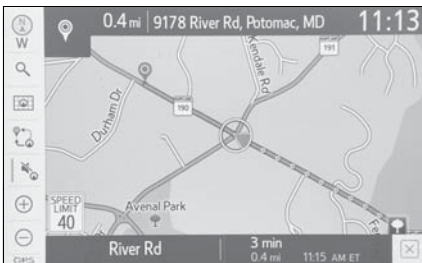

#### Stop recording the route trace

- 1 Select  on the map screen. (→P.72)
- 2 Select “Route Trace” again.

- 3 A confirmation screen will be displayed.

“Yes”: Select to keep the recorded route trace.

“No”: Select to erase the recorded route trace.

- The traveled route can be stored up to approximately 621 miles (1000 km).

### Displaying information about the icon where the cursor is set

When the cursor is placed over an icon on the map screen, the name is displayed at the top of the screen. If  is shown to the right of the name, detailed information can be displayed.

- 1 Place the cursor over an icon.
- 2 Select .

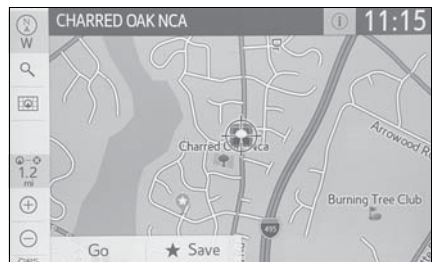

### 3 Check that the information screen is displayed.

Information 12:09

Name : \*\*\*\*\*

Address : \*\*\*\*\*  
Washington, DC

Position : N38°53'31" W77°3'0"

Phone # : \*\*\*\*\*

Go ★ Save

★ “Save”: Select to register as a memory point. To change the icon, name, etc.: →P.102

“Go”/“Enter”: Select to set as a destination.

: Select to call the registered number.







“Delete”: Select to delete destination or memory point.

“Edit”: Select to display the edit memory point screen.

- Even when traffic information is not currently being received, traffic information and  will be displayed for a while after traffic information has been received.
- In some situations, calls to a POI may automatically change to an international call or may not be possible as a domestic call.

## Standard map icons

Icon	Name
	Park/Recreation
	Business facility
	Airport

Icon	Name
	Military
	University
	Hospital
	Stadium
	Shopping
	Golf course

## Traffic information\*

\*: This function is not made available in some countries or areas.

**Traffic data can be received via HD Radio broadcast or via DCM (Data Communication Module) to display traffic information on the map screen.**

## Displaying the traffic incidents screen

1 Press the "MENU" button.

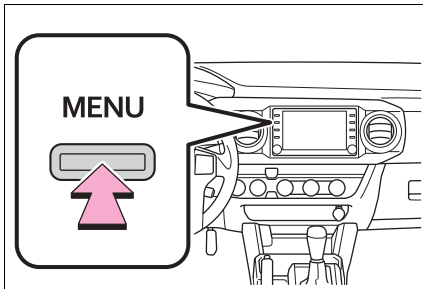

2 Select "Info".

3 Select "Traffic Incidents".

▶ When the route has not been set

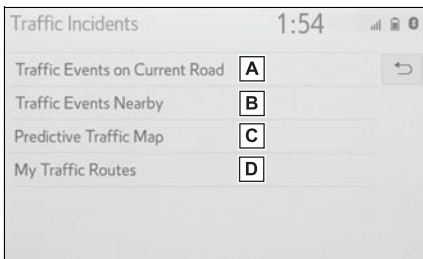

**A** Select to display traffic information for the current road. (→P.82)

**B** Select to display nearby traffic information. (→P.82)

**C** Select to display a map with predictive traffic data. (→P.82)

**D** Select to display traffic along the saved routes. (→P.82)

▶ When the route has been set

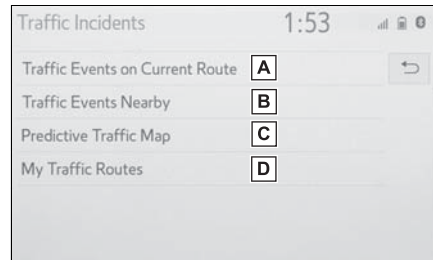

**A** Select to display traffic information for the set route. (→P.82)

**B** Select to display nearby traffic information. (→P.82)

**C** Select to display a map with predictive traffic data. (→P.82)

**D** Select to display traffic along the saved routes. (→P.82)

● If a large amount of information is being received, it may take longer than normal for the information to be displayed on the screen.

● If traffic information cannot be received because the vehicle is outside of HD Radio coverage area, it may still be able to be received using DCM. (→P.172)

### Displaying traffic information

A list of current traffic information can be displayed along with information on the location of each incident.

- 1 Display the traffic incidents screen. (→P.81)
- 2 Select “Traffic Events on Current Road”, “Traffic Events on Current Route” or “Traffic Events Nearby”.
- 3 Select the desired traffic information.
  - ▶ When “Traffic Events Nearby” is selected, depending on whether the traffic flow information is enabled/disabled, the following will be displayed:

When enabled: Traffic event and congestion information

When disabled: Traffic event information only

- 4 Check that the traffic information is displayed.

“Detail”: Select to display detailed traffic information.

### Displaying predictive traffic information

A map with predictive traffic data can be displayed.

- 1 Display the traffic incidents screen. (→P.81)
- 2 Select “Predictive Traffic Map”.

- 3 Scroll the map to the desired point (→P.75) and set the time of predictive traffic information.

- The time of the predictive traffic information can be changed in 15-minute intervals up to +45 minutes.

“<”: Moves the time forward 15 minutes.

“>”: Moves the time back 15 minutes.

### My traffic routes

Traffic information along the saved routes can be displayed. To use this function, it is necessary to register a route.

(→P.110)

- 1 Display the traffic incidents screen. (→P.81)
- 2 Select “My Traffic Routes”.
  - If map data has been updated, a confirmation screen will be displayed. Select “OK” or “Do Not Tell Me Again”.
- 3 Select the desired route.

“Options”: Select to add, edit or delete personal traffic routes. (→P.110)

- If routes have not been registered yet, a confirmation screen will be displayed. Select “Yes” to register the route.
- 4 Select the desired traffic information.



- 5 Check that the traffic information is displayed.

“Detail”: Select to display detailed traffic information.

## Displaying traffic information on the map

- 1 Select  on the map screen.
- 2 Select “Traffic Information”.
- 3 Check that the traffic information is displayed.

- 
- The icons indicate traffic incidents such as construction, accidents, etc. Select an icon to hear more detail by voice.
  - The arrows indicate the flow of traffic. The color changes depending on the speed.

## Destination search operation

### Destination screen

The destination screen enables to search for a destination. The destination screen can be reached by the following methods:

#### ■ From the map screen

- 1 Press the “MAP” button.
- 2 Select .
- 3 Follow the steps in “From the menu screen” from step 3. (→P.84)

#### ■ From the menu screen

- 1 Press the “MENU” button.
- 2 Select “Destination”.
- 3 Select the desired search method.

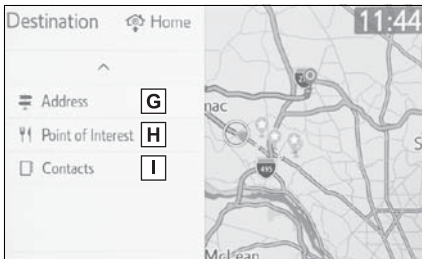
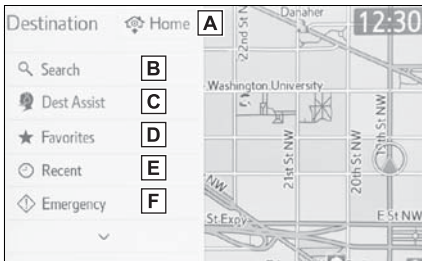

- A** Select to set a destination by home. (→P.85)
- B** Select to search for a destination by entering keywords. (→P.85)
- C** Select to search for a destination via the Toyota response center.\* (→P.292)
- D** Select to search for a destination from a registered entry in “Favorites”. (→P.86)
- E** Select to search for a destination from recent set destinations. (→P.86)
- F** Select to search for a destination from emergency service points. (→P.86)
- G** Select to search for a destination by address. (→P.87)
- H** Select to search for a destination by point of interest. (→P.88)
- I** Select to search for a destination from contact data which had been transferred to the navigation system from a registered Bluetooth® phone. (→P.87)

\*: This function is not made available in some countries or areas.

- To hide the destination screen, touch any part of the map screen.

## Selecting search area

The selected state (province) can be changed to set a destination from a different state (province) by using “Address” or “Point of Interest”.

- 1 Display the destination screen. (→P.84)
- 2 Select “Address” or “Point of Interest”.
- 3 Select “Change State/Province”.
- If a state (province) has not been selected yet, “State/Province” screen is displayed directly.
- 4 Select the desired state (province).

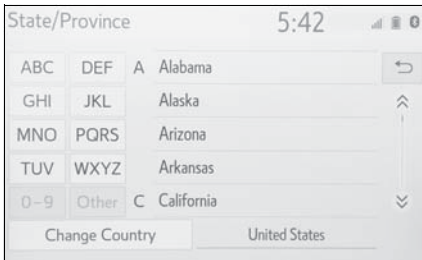

- To change countries, select “Change Country”.

## Setting home as destination

To use this function, it is necessary to register a home address. (→P.102)

- 1 Display the destination screen. (→P.84)

- 2 Select  “Home”.

- The navigation system performs a search for the route and the route overview is displayed. (→P.92)

## Searching by keyword

The destination can be searched by entering various keywords.

- 1 Display the destination screen. (→P.84)
- 2 Select “Search”.
- 3 Enter characters on the keyboard.



- 4 Select “Search”.
- 5 When there is more than 1 result, select the desired item from the list.

 : Select to display updated information about the selected entry. This function is displayed only when there is information from the Cloud.

- To search for a facility name using multiple search words, put a space between each word.
- Search results may differ depending on the connected services subscription status and communi-

cation status.

### Searching by favorites list

To use this function, it is necessary to register a favorites list entry. (→P.103)

- 1 Display the destination screen. (→P.84)
- 2 Select “Favorites”.
- 3 Select the desired favorites list entry.

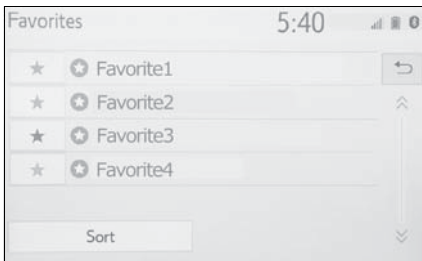

### Searching by Destination Assist\*

\*: This function is not made available in some countries or areas.

A Destination Assist operator can search for a destination. You can request a specific business, address, or ask for help locating your desired destination. (→P.292)

- 1 Display the destination screen. (→P.84)
- 2 Select “Dest Assist”.

### Searching by recent destinations

- 1 Display the destination screen. (→P.84)
- 2 Select “Recent”.
- 3 Select the desired destination.

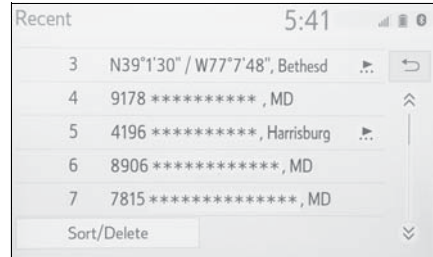

“Sort/Delete”: Select to sort (date, name) or delete destination(s).

- Up to 100 previously set destinations are displayed on the screen.

### Deleting recent destinations

- 1 Select “Sort/Delete”.
- 2 Select “Delete Recent Destinations”.
- 3 Select the desired recent destination(s) to be deleted.
- 4 Select “Yes” when the confirmation screen appears.

“Sort/Delete All”: Select to sort (date, name) destinations or delete all.

### Searching by emergency

- 1 Display the destination screen. (→P.84)

- 2 Select "Emergency".
- 3 Select the desired emergency category.
- 4 Select the desired destination.

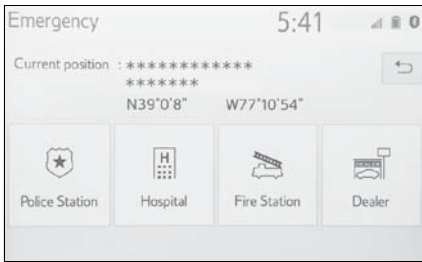

- The navigation system does not guide in areas where route guidance is unavailable. (→P.114)

### Searching by contact

To use this function, it is necessary to have contact data which had been transferred to the navigation system from a registered Bluetooth® phone. (→P.254)

- 1 Display the destination screen. (→P.84)
- 2 Select "Contacts".
- 3 Select the desired contact.

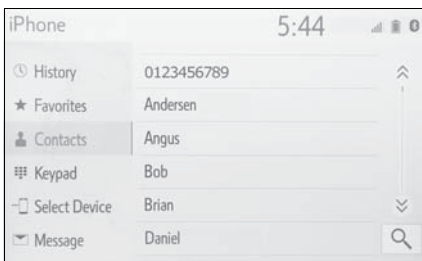

- 4 Select "Addresses".
- 5 Select the desired address.

- 6 Follow the steps in "Searching by keyword" from step 4. (→P.85)

- This function may not be available depending on the type of Bluetooth® phone.

### Searching by address

- 1 Display the destination screen. (→P.84)
- 2 Select "Address".
- 3 Enter a house number and select "Search".

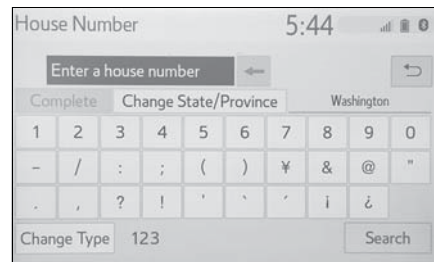

- 4 Enter a street name and select "Search".
  - 5 Select the desired street name.
  - 6 Enter a city name and select "Search".
  - 7 Select the desired city name.
- If multiple locations with the same address exist, the address list screen will be displayed. Select the desired address.

- A street name can be searched using only the body part of its name.  
For example: S WESTERN AVE

- A search can be performed by entering “S WESTERN AVE”, “WESTERN AVE” or “WESTERN”.

### Searching by point of interest

There are 3 methods to search for a destination by Points of Interest.

- 1 Display the destination screen. (→P.84)
- 2 Select “Point of Interest”.
- 3 Select the desired search method.

Point of Interest 5:44

Change State/Province **A** : Washington

Please select a method to search for a point of interest (POI):

Name **B**

Category **C**

Phone # **D**

- A** Select to change the search area. (→P.85)
- B** Select to search by name. (→P.88)
- C** Select to search by category. (→P.89)
- D** Select to search by phone number. (→P.89)

### Searching by name

- 1 Select “Name”.
- 2 Enter a POI name and select “Search”.

- 3 Select the desired POI.

“Sort/Category/City”: Select to sort (name, distance) the displayed entries, change the POI category, or enter a city name.

- When entering the name of a specific POI, and there are 2 or more sites with the same name, the list screen will be displayed. Select the desired POI.

- To search for a facility name using multiple search words, put a space between each word.

### Selecting a city to search

- 1 Select “Sort/Category/City”.
- 2 Select “Enter a city name”.
- 3 Enter a city name and select “Search”.

“Any City”: Select to cancel the city setting.

- 4 Select the desired city name.
- 5 Select the desired POI.

### Selecting from the categories

- 1 Select “Sort/Category/City”.
- 2 Select “Change POI category”.
- 3 Select the desired category.
- If there is more than 1 result for the selected category, a detailed list will be displayed.

“List All Categories”: Select to display all POI categories.

- 4 Select the desired POI.

## Searching by category

- 1 Select "Category".
- 2 Select the desired search point.

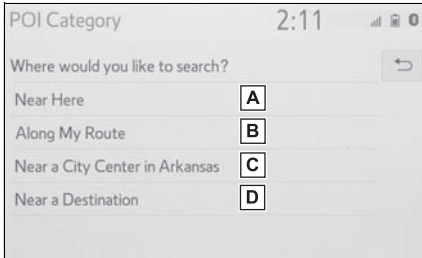

- A** Select to search for POIs near your current position.
  - B** Select to search for POIs along the set route.
  - C** Select to search for POIs near a specific city center. (→P.89)
  - D** Select to search for POIs near a destination.  
When more than 1 destination has been set, a list will be displayed on the screen. Select the desired destination.
- 3 Select the desired POI category.
    - If there is more than 1 result for the selected category, a detailed list will be displayed.
    - Select "Other POIs" to select other than default POI categories. The following button can be displayed.

"List All Categories": Select to dis-

play all POI categories.

"Favorite POI Categories": Select to use the 6 POIs that have been previously set. (→P.107)

- 4 Select the desired POI.

- The names of POIs located within approximately 200 miles (320 km) from the selected search point can be displayed. They are displayed up to 200 names.

## When "Near a City Center in XX\*" is selected

- 1 Select "Near a City Center in XX\*".
- 2 Enter a city name and select "Search".

"Last 5 Cities": Select the desired city name from the list of the last 5 cities.

- 3 Select the desired city name.
- 4 Select "OK" when the city center map screen is displayed.
- 5 Follow the steps in "Searching by category" from step 3. (→P.89)

\*: XX represents the selected search area name.

- If the navigation system has never been used, selecting the city name from "Last 5 Cities" will not be available.

## Searching by phone number

- 1 Select "Phone #".

- 2 Enter a phone number and select “OK”.
- If multiple locations with the same phone number exist, the list screen will be displayed.
- 
- If there is no match for the entered phone number, a list of identical numbers with different area codes will be displayed.

### One-touch setting home/favorite as a destination

To use this function, it is necessary to register a home and/or a favorite location. Up to 2 favorites can be registered as preset destinations. (→P.102, 103)

To set the home or a preset destination as the destination, select the corresponding button.

- 1 Turn the engine switch to ACC or ON.
- 2 Press the “MAP” button.
- 3 Select the desired item.

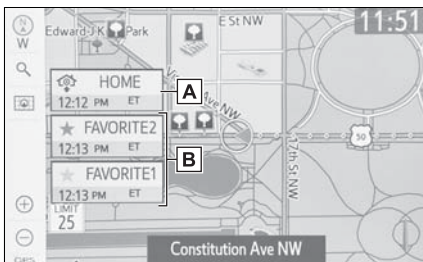

- A** Select to set the registered home as the destination.
- B** Select to set a registered

favorite as the destination. (Up to 2 favorites can be registered as preset destinations.)

- The estimated time of arrival to the registered home and preset destinations from the current position will be displayed.
  - If the home or a preset destination has not been registered, “Save Home” or “Save Favorite” will be displayed, respectively. To register a home or preset destination, select the corresponding button.
- 
- When the destination is very close to the current position, “Nearby” will be displayed.
  - The one-touch buttons for home and favorites will disappear after the vehicle has been driven for a while.
  - The color of the estimated arrival time indicator may change depending on the traffic information received.
  - This function is available when “Automatic Destination List Info” is set to on. (→P.106)



## Starting route guidance

When the destination is set, the entire route map from the current position to the destination is displayed.

### Starting route guidance

- 1 Select “Go” on the confirm destination screen.

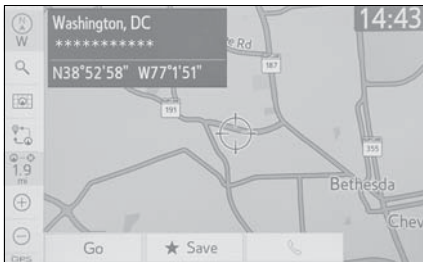

- For details about this screen:  
→P.91
- 2 Select “OK” on the route overview screen.

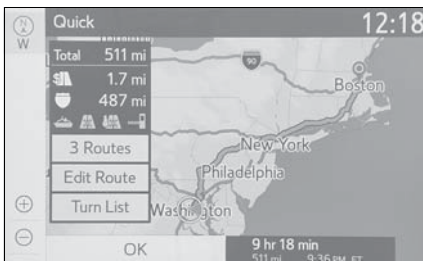

- For details about this screen:  
→P.92
- The route for returning may not be the same as that for going.
  - The route guidance to the destination may not be the shortest route or a route without traffic congest-

tion.

- Route guidance may not be available if there is no road data for the specified location.
- When setting the destination on a map with a scale more than 0.5 miles (800 m), the map scale changes to 0.5 miles (800 m) automatically. If this occurs, set the destination again.
- If a destination that is not located on a road is set, the vehicle will be guided to the point on a road nearest to the destination. The road nearest to the selected point is set as the destination.

### ! WARNING

- Be sure to obey traffic regulations and keep road conditions in mind while driving. If a traffic sign on the road has been changed, the route guidance may not indicate such changed information.

### Confirm destination screen

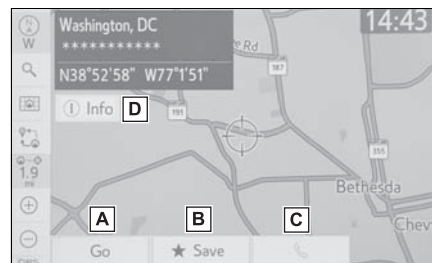

- A Select to search for the route.  
(→P.91)

- If a destination has already been set, “Go Directly” and “Add to Route” will be displayed.

“Go Directly”: Select to delete the existing destination(s) and set a new one.

“Add to Route”: Select to add a destination to the current route.

- B** Select to register as a memory point.
- C** Select to call the registered number.
- D** Select to update information about the selected entry.\*

\*: This function is displayed only when there is information from the Cloud. (→P.85)

### Route overview screen

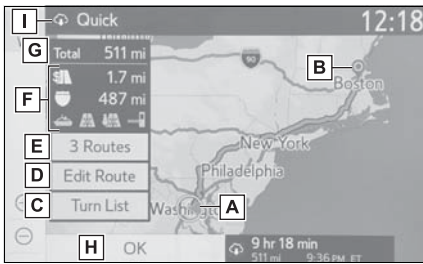

- A** Current position
- B** Destination point
- C** Select to display a list of the turns required to reach the destination. (→P.93)
- D** Select to change the route. (→P.93)
- E** Select the desired route from 3 possible routes. (→P.92)
- F** Type of route and its distance
- G** Distance of the entire route
- H** Select to start guidance.  
Select and hold to start demo

mode. (→P.92)

- I** Displayed when the route displayed is from the Cloud. (→P.94)

### Starting demo mode

Before starting the route guidance, the demonstration of the route guidance can be viewed.

- 1 Select and hold “OK” on the route overview screen until a beep sounds.
- Press the “HOME” or “MAP” button to end demo mode.

### 3 routes selection

- 1 Select “3 Routes”.
- 2 Select the desired route.



- A** Displayed when the route displayed is available from the Cloud. (☁)
- B** Select to display the quickest route.
- C** Select to display the route that is the shortest distance to the set destination.
- D** Select to display the alterna-

tive route.

- E** Select to display the information about the 3 routes.  
(→P.93)

### Displaying 3 routes information

- 1 Select **i** “Info”.
- 2 Check that the 3 routes information screen is displayed.



- A** Time necessary for the entire trip
- B** Distance of the entire trip
- C** Distance of the toll road
- D** Distance of the freeway
- E** Distance of the ferry trip

### Displaying turn list

A list of turn information from the current position to the destination can be displayed.

- 1 Select “Turn List”.

- 2 Check that the turn list is displayed.

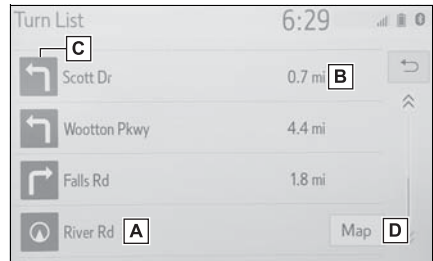

- A** Current position
- B** Distance to the next turn
- C** Turn direction at the intersection
- D** Select to display the map of the selected point.

- Not all road names on the route may appear on the list. If a road changes its name without requiring a turn (such as on a street that runs through 2 or more cities), the name change will not appear on the list. The street names will be displayed in order from the starting point, along with the distance to the next turn or the destination.

### Editing route

Destinations can be added, reordered or deleted, and conditions for the route to the destination can be changed.

- 1 Select “Edit Route”.

## 2 Select the desired item.

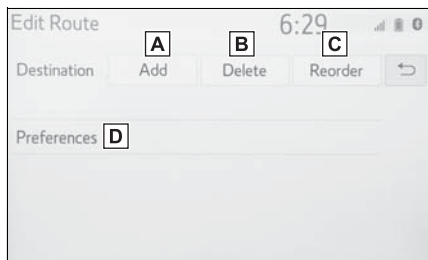

- A** Select to add destinations. (→P.94)
- B** Select to delete destinations. (→P.94)
- C** Select to reorder destinations. (→P.100)
- D** Select to set route preferences. (→P.100)

### Adding destinations

- ▶ When the vehicle is stopped
  - 1 Select “Add”.
  - 2 Search for an additional destination in the same way as a destination search. (→P.84)
- Up to 5 destinations can be set.
- 3 Select “Add” at the position in the route which you want to add the destination.
- ▶ While driving
  - 1 Select “Add”.
  - 2 Search for an additional destination in the same way as a destination search. (→P.84)
- Up to 5 destinations can be

set.

## 3 Select “Beginning” or “End”.

### Deleting destinations

- 1 Select “Delete”.
  - 2 Select “Yes” when the confirmation screen appears.
- If more than 1 destination has been set, select the destination(s) to be deleted. (The navigation system will recalculate route(s) to the remaining set destination(s).)

### A route from the Cloud\*

\*: This function is not made available in some countries or areas.

When starting route guidance or rerouting, a route can be provided automatically by the Cloud. This function is available when dynamic route setting is enabled. (→P.106)

## Route guidance screen

During the route guidance, various types of guidance screens can be displayed depending on conditions.

### Screen for route guidance

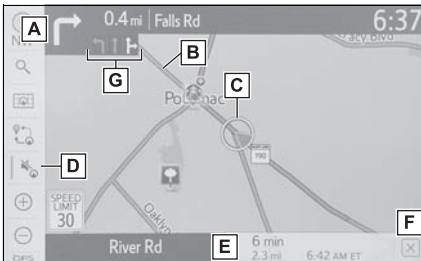

- A** Distance to the next turn and an arrow indicating the turning direction
- B** Guidance route
- C** Current position
- D** Select to mute the voice guidance.
- E** Route information (→P.95)
- F** Select to delete destinations. (→P.22)
- G** Displays the lane recommendation (→P.96)

- If the vehicle goes off the guidance route, the route will be recalculated.
- For some areas, the roads have not been completely digitized in our database. For this reason, the route guidance may select a road

that should not be traveled on.

- When arriving at the set destination, the destination name will be displayed on the upper part of the screen.
- When the automatic zoom function is enabled, the map will automatically change to a detailed map as the vehicle approaches a guidance point. (→P.107)

### Distance and time to destination

When the vehicle is on the guidance route, the route information bar displays the distance with the estimated travel/arrival time to the destination.

- ▶ When the set destination is 1
  - 1 Check that the distance and time to destination is displayed.



- ▶ When the set destinations are more than 1
  - 1 Select the route information bar.

- 2 Check that the list of the distance and time is displayed.

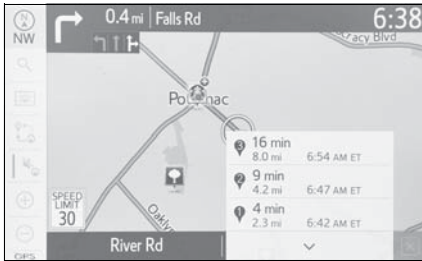

- By selecting one of the number buttons, the desired route information is displayed.
- When the vehicle is on the guidance route, the distance measured along the route is displayed. Travel time and arrival time are calculated based on the average speed of the specified speed limits and current traffic information.
- When the vehicle gets off the guidance route, the arrow facing the destination is displayed instead of the estimated travel/arrival time.
- The route information bar fills from left to right as the vehicle progresses along the route.

### Lane recommendation

When approaching a turning point, the lane recommendation will automatically be displayed on the map.



### During freeway driving

During freeway driving, the freeway information screen can be displayed.

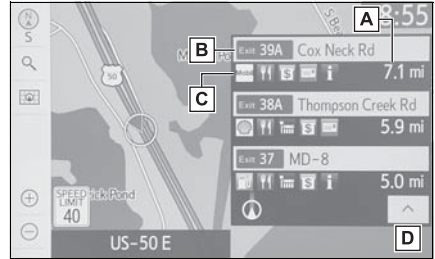

- A Distance from the current position to the freeway exit/rest area
- B Name of the freeway exit/rest area
- C POIs that are close to a freeway exit
- D Select to display farther freeway exits/rest areas.

### When approaching freeway exit or junction

When the vehicle approaches an exit or junction, the freeway guidance screen will be displayed.

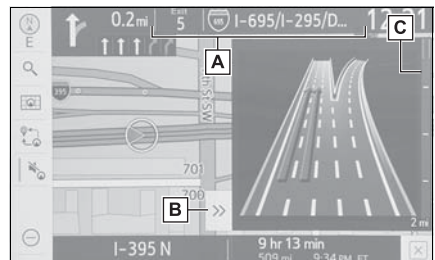

- A** Next exit or junction name
- B** Select to hide the freeway guidance screen.
  - To return to the freeway guidance screen, press the “MAP” button.
- C** Remaining distance bar to the guidance point

- This function is available when “Intersection Zoom Map” is set to on. (→P.106)

### When approaching toll-gate

When the vehicle approaches a tollgate, the tollgate view will be displayed.

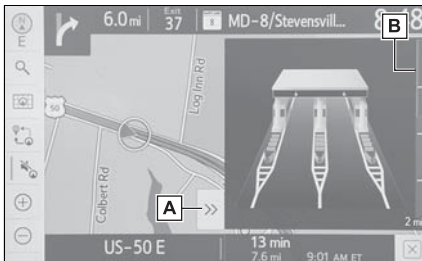

- A** Select to hide the tollgate guidance screen.
    - To return to the tollgate guidance screen, press the “MAP” button.
  - B** Remaining distance bar to the guidance point
- 
- This function is available when “Intersection Zoom Map” is set to on. (→P.106)

### When approaching junction

When the vehicle approaches a

junction, the junction view with signage will be displayed.

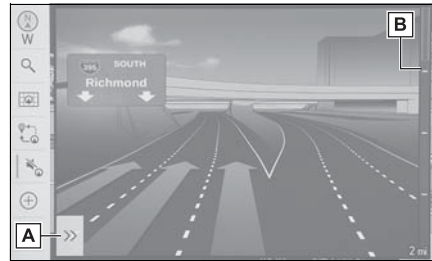

- A** Select to hide the real freeway junction view.
    - To return to the real freeway junction view, press the “MAP” button.
  - B** Remaining distance bar to the guidance point
- 
- This function is available when “Intersection Zoom Map” is set to on. (→P.106)

### When approaching intersection

When the vehicle approaches an intersection, the intersection guidance screen will be displayed.

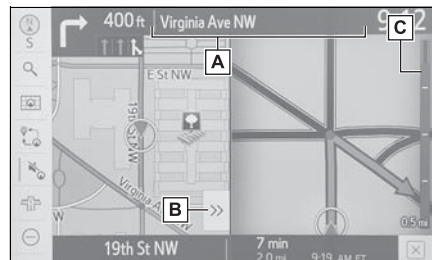

- A** Next street name
- B** Select to hide the intersection guidance screen.
  - To return to the intersection guid-

ance screen, press the “MAP” button.

- C** Remaining distance bar to the guidance point

- This function is available when “Intersection Zoom Map” is set to on. (→P.106)

### Turn list screen

- 1 Select “Turn List” on the map mode screen. (→P.77)
- 2 Check that the turn list screen is displayed.

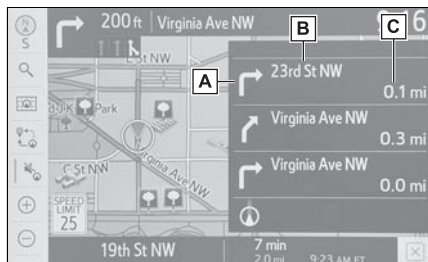

- A** Turn direction
- B** Next street or destination name
- C** Distance between turns

### Turn-by-turn arrow screen

On this screen, information about the next turn on the guidance route can be displayed.

- 1 Select “Turn-by-Turn Arrow” on the map mode screen. (→P.77)

- 2 Check that the turn-by-turn arrow screen is displayed.



- A** Exit number or street name
- B** Turn direction
- C** Distance to the next turn



## Typical voice guidance prompts

As the vehicle approaches an intersection, or point, where maneuvering the vehicle is necessary, the navigation system's voice guidance will provide various messages.

- If a voice guidance command cannot be heard, press the "MAP" button to hear it again.
- To adjust the voice guidance volume: →P.64
- To mute the voice guidance: →P.95
- Voice guidance may be made early or late.
- If the navigation system cannot determine the current position correctly, you may not hear voice guidance or may not see the magnified intersection on the screen.

### WARNING

- Be sure to obey the traffic regulations and keep the road condition in mind especially when you are driving on IPD roads (roads that are not completely digitized in our database). The route guidance may not have the updated information such as the direction of a one way street.

## Editing route

### Displaying the edit route screen

- 1 Select  on the map screen. (→P.72)
- 2 Select the desired item to be set.

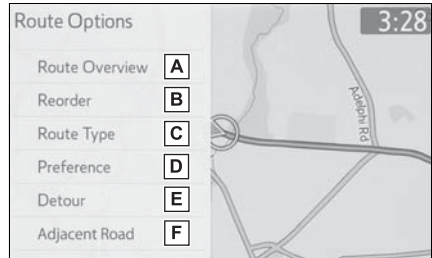

- A** Select to display the overview of the entire route. (→P.92)
  - B** Select to reorder destinations. (→P.100)
  - C** Select to change route type. (→P.100)
  - D** Select to set route preferences. (→P.100)
  - E** Select to set detours. (→P.100)
  - F** Select to start from adjacent road. (→P.101)
- To hide the route options screen, touch any part of the map screen.
- 3 Check that the route overview is displayed. (→P.92)

### Reordering destinations

When more than 1 destination has been set, the arrival order of the destinations can be changed.

- 1 Select  on the map screen. (→P.72)
- 2 Select “Reorder”.
- 3 Select the desired destination and select “Move Up” or “Move Down” to change the arrival order. Then select “OK”.

### Selecting route type

- 1 Select  on the map screen. (→P.72)
- 2 Select “Route Type”.
- 3 Select the desired route type.

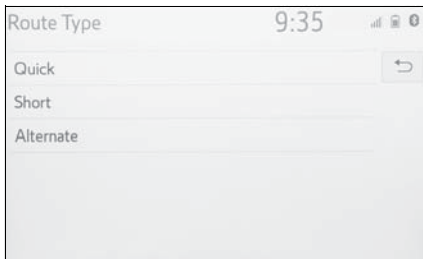

- The entire route from the starting point to the destination is displayed. (→P.92)
- During driving, the route guidance starts after selecting the desired route type.

### Setting route preferences

The conditions to determine the route can be selected from various choices such as freeways, toll roads, ferries, etc.

- 1 Select  on the map screen. (→P.72)
- 2 Select “Preference”.
- 3 Select the desired route preferences and select “OK”.

- Even if the “Avoid Freeways” route preference is turned off, the route may not be able to avoid freeways in some cases.
- If the calculated route includes a trip by ferry, the route guidance shows a sea route. After traveling by ferry, the current position may be incorrect. Upon reception of GPS signals, it is automatically corrected.

### Detour setting

During the route guidance, the route can be changed to detour around a section of the route where a delay is caused by road repairs, an accident, etc.

- 1 Select  on the map screen. (→P.72)
- 2 Select “Detour”.

**3** Select the desired detour distance.

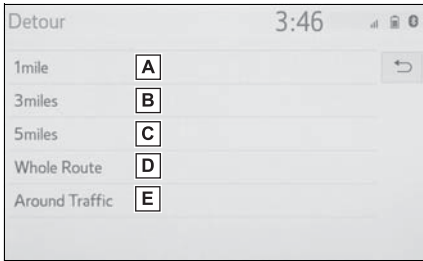

- A** Select to detour within 1 mile of the current position.
- B** Select to detour within 3 miles of the current position.
- C** Select to detour within 5 miles of the current position.
- D** Select to detour on the entire route.
- E** Select to make the navigation system search for the route based on traffic congestion information received from traffic information.\* (→P.81)

\*: This function is not made available in some countries or areas.

● This picture shows an example of how the navigation system would guide around a delay caused by a traffic jam.

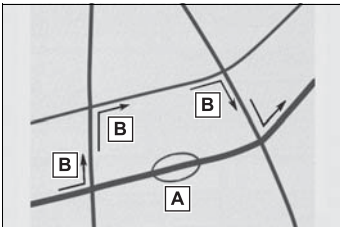

**A** This position indicates the loca-

tion of a traffic jam caused by road repairs, an accident, etc.

**B** This route indicates the detour suggested by the navigation system.

- When the vehicle is on a freeway, the detour distance selections are 5, 15 and 25 miles (or 5, 15 and 25 km if units are in km).
- The navigation system may not be able to calculate a detour route depending on the selected distance and surrounding road conditions.

**Adjacent road**

When a freeway and a surface road run in parallel, the navigation system may show the guidance route going on the freeway while driving on the surface road, or vice versa.

If this happens, you can instantly choose the adjacent road for the route guidance.

- 1** Select  on the map screen. (→P.72)
- 2** Select “Adjacent Road”.

● When there is no adjacent road, this screen button will not be displayed.

## Navigation settings

Home, favorites list entries, areas to avoid can be set as memory points. The registered points can be used as the destinations. (→P.84)

Registered areas to avoid, will be avoided when the navigation system searches for a route.

## Displaying navigation settings screen

- 1 Press the “MENU” button.

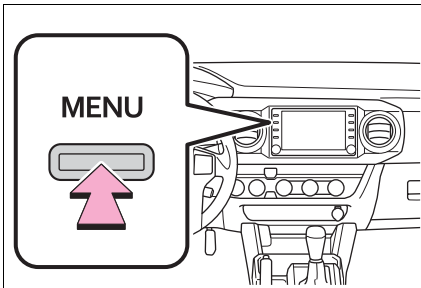

- 2 Select “Setup”.
- 3 Select “Navigation”.
- 4 Select the desired item to be set.

## Navigation settings screen

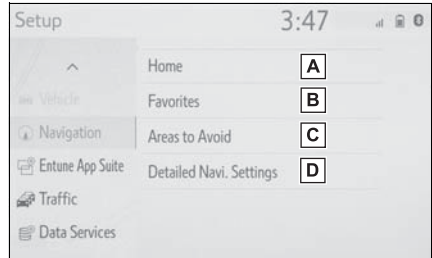

- A** Select to set home. (→P.102)
- B** Select to set the favorites list. (→P.103)
- C** Select to set areas to avoid. (→P.104)
- D** Select to set detailed navigation settings. (→P.106)

- When “Useful Navi. Information Settings” is displayed on the screen: →P.113

## Setting up home

If home has been registered, that information can be recalled by selecting  “Home” on the destination screen. (→P.84)

## Registering home

- 1 Display the navigation settings screen. (→P.102)
- 2 Select “Home”.
- 3 Select the desired item to search for the location. (→P.84)

- 4 Select “OK” when the editing home screen appears.

### Editing home

- 1 Display the navigation settings screen. (→P.102)
- 2 Select “Home”.
- 3 Select the desired item to be edited.

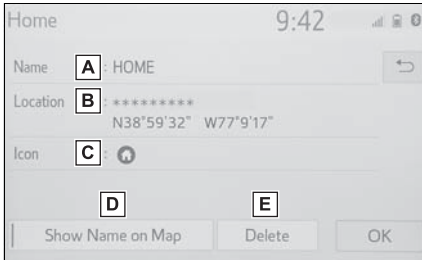

- A Select to edit the home name.
  - B Select to edit location information.
  - C Select to change the icon to be displayed on the map screen. (→P.104)
  - D Select to set display of the home name on/off.
  - E Select to delete registered home location.
- 4 Select “OK”.

### Setting up favorites list

Points on the map can be registered.

- 1 Display the navigation settings screen. (→P.102)

- 2 Select “Favorites”.
- 3 Select the desired item.

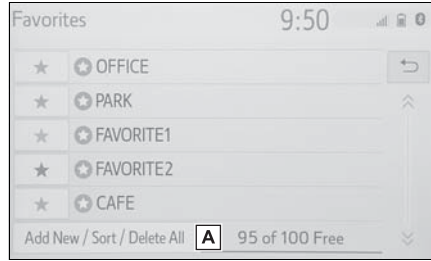

- A Select to edit the favorites list.

“Add New”: Select to register favorites list entries. (→P.103)

“Sort”: Select to sort (date, name, icon) favorite list entries.

“Delete All”: Select to delete all favorite list entries.

### Registering favorites list entries

- 1 Select “Add New/Sort/Delete All”.
- 2 Select “Add New”.
- 3 Select the desired item to search for the location. (→P.84)
- 4 Select “OK” when the editing favorites list screen appears. (→P.104)

- Up to 100 favorites list entries can be registered.

### Editing favorites list entries

The icon, name, location and/or

phone number of a registered favorites list entry can be edited.

- 1 Select the desired favorites list entry.
  - Each time a star icon is selected, its color will change. Colored star icons indicate that the favorite is registered to the corresponding preset destination button. Up to 2 entries can be registered as quick favorite destinations. (→P.90)
- 2 Select the desired item to be edited.

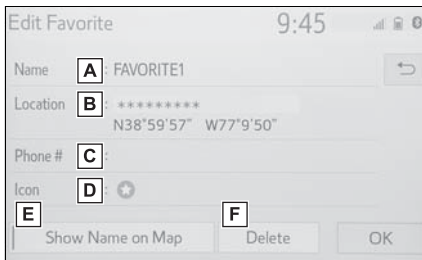

- A** Select to edit the favorites list entry name.
- B** Select to edit location information.
- C** Select to edit the phone number.
- D** Select to change the icon to be displayed on the map screen. (→P.104)
- E** Select to set display of the favorites list entry name on/off.
- F** Select to delete the favorites list entry.

- 3 Select “OK”.

### Changing the icon

- 1 Select “Icon”.
- 2 Select the desired icon.

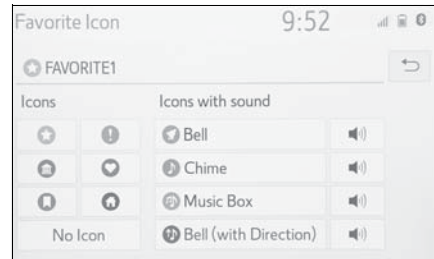

### ■ Icons with sound

A sound for some favorites list entries can be set. When the vehicle approaches the location of the favorites list entry, the selected sound will be heard.

 : Select to play the sound.

- When “Bell (with Direction)” is selected, select an arrow to adjust the direction and select “OK”.
- The bell sounds only when the vehicle approaches this point in the direction that has been set.

### Setting up areas to avoid

Areas to be avoided because of traffic jams, construction work or other reasons can be registered as “Areas to Avoid”.

- 1 Display the navigation settings screen. (→P.102)
- 2 Select “Areas to Avoid”.

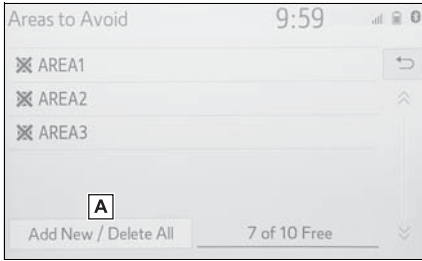
**3** Select the desired item.

**A** Select to edit the list of areas to avoid.

“Add New”: Select to register areas to avoid. (→P.105)

“Delete All”: Select to delete all areas to avoid.

### Registering areas to avoid

- 1** Select “Add New/Delete All”.
- 2** Select “Add New”.
- 3** Select the desired item to search for the location. (→P.84)
- 4** Select “+” or “-” to change the size of the area to be avoided and select “OK”.



**5** Select “OK” when the area to avoid screen appears.

● If a destination is entered in the area to avoid or the route calculation cannot be made without run-

ning through the area to avoid, a route passing through the area to be avoided may be shown.

● Up to 10 locations can be registered as points/areas to avoid.

### Editing areas to avoid

The name, location and/or area size of a registered area can be edited.

- 1** Select the desired area.
- 2** Select the desired item to be edited.

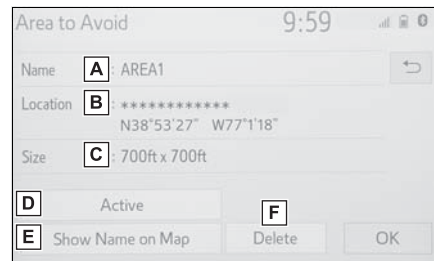

- A** Select to edit the name of the area to avoid.
  - B** Select to edit area location.
  - C** Select to edit area size.
  - D** Select to set the area to avoid function on/off.
  - E** Select to set display of the area to avoid name on/off.
  - F** Select to delete the area to avoid.
- 3** Select “OK”.

## Detailed navigation settings

Settings are available for pop-up information, favorite POI categories, low fuel warning, etc.

### Displaying the detailed navigation settings screen

- 1 Press the "MENU" button.

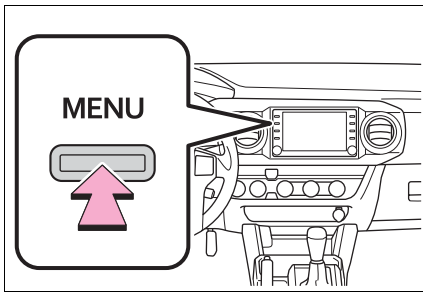

- 2 Select "Setup".
- 3 Select "Navigation".
- 4 Select "Detailed Navi. Settings".
- 5 Select the desired items to be set.

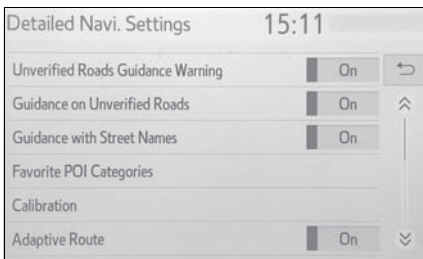

## Detailed navigation settings screen

- "Unverified Roads Guidance Warning"

Select to set unverified roads guidance warning on/off.

- "Guidance on Unverified Roads"

Select to set IPD road (roads that are not completely digitized in our database) guidance on/off.

- "Guidance with Street Names"

Select to set the voice guidance for the next street name on/off.

- "Favorite POI Categories"

Select to set favorite POI categories that are used for POI selection to display on the map screen. (→P.107)

- "Calibration"

Select to adjust the current position mark manually or to adjust miscalculation of the distance caused by tire replacement. (→P.108)

- "Adaptive Route"

Select to enable/disable adaptive routes. When enabled, the navigation system will provide frequently used routes.

- "Reset Adaptive Route"

Select to erase adaptive route data.

- "Automatic Destination List Info"

Select to set automatic destination list information on/off. When set to on, the estimated time of arrival to the registered home and preset



destinations from the current position will be displayed.

- “Intersection Zoom Map”

Select to set display of a guidance screen on/off.

- “Automatic Zoom”

Select to set automatic zoom function on/off. When it is enabled, as the vehicle approaches a guidance point, the map will change to a detailed map automatically.

- “State Border Guidance”

Select to set cross-border guidance on/off.

- “Map Color Customization”

Select to set the map display color.

- “Map Animation”

Select to set map animation on/off.

- “Dynamic Route”\*

Select to enable/disable routes sourced from the Cloud. (→P.94)

- “Restore the default settings”

Select to reset all setup items.

\*: This function is not made available in some countries or areas.

### **Favorite POI categories (Select POI icons)**

Up to 6 POI icons, which are used for selecting POIs on the map screen, can be selected as favorites.

- 1 Display the detailed navigation settings screen. (→P.106)

- 2 Select “Favorite POI Categories”.
- 3 Select the desired category to be changed.

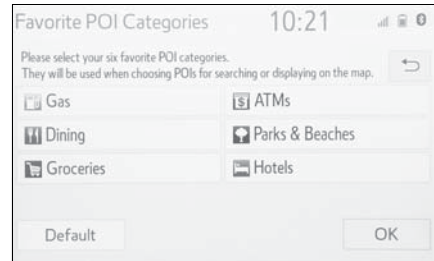

“Default”: Select to set the default categories.

- 4 Select the desired POI category.

“List All Categories”: Select to display all POI categories.

- 5 Select the desired POI icon.
- 6 Select “OK”.

### **Current position/Tire change calibration**

The current position mark can be adjusted manually. Miscalculation of the distance caused by tire replacement can also be adjusted.

- 1 Display the detailed navigation settings screen. (→P.106)
  - 2 Select “Calibration”.
  - 3 Select the desired item.
- For additional information on the accuracy of a current position: →P.114

## Position/Direction calibration

When driving, the current position mark will be automatically corrected by GPS signals. If GPS reception is poor due to location, the current position mark can be adjusted manually.

- 1 Select "Position/Direction".
- 2 Scroll the map to the desired point (→P.75) and select "OK".
- 3 Select an arrow to adjust the direction of the current position mark and select "OK".

## Tire change calibration

The tire change calibration function will be used when replacing the tires. This function will adjust miscalculation caused by the circumference difference between the old and new tires.

- 1 Select "Select after a Tire Change".
- The message appears and the quick distance calibration starts automatically.

- If this procedure is not performed when the tires are replaced, the current position mark may be incorrectly displayed.

## Traffic settings\*

\*: This function is not made available in some countries or areas.

**Traffic information such as traffic congestion or traffic incident warnings can be made available.**

## Displaying the traffic settings screen

- 1 Press the "MENU" button.

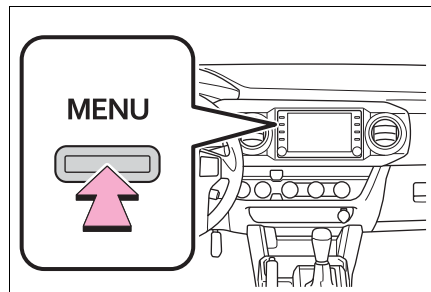

- 2 Select "Setup".
- 3 Select "Traffic".
- 4 Select the desired items to be set.

## Screen for traffic settings

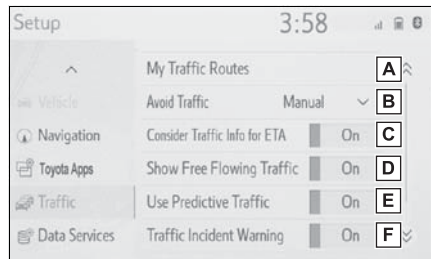

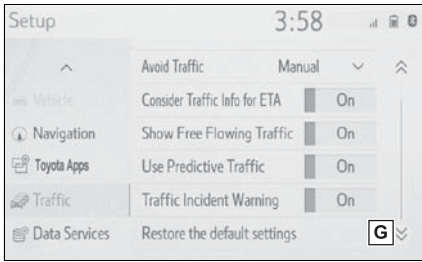

- A** Select to set specific routes (such as frequently used routes) on which you wish to receive traffic information. (→P.110)
- B** Select to set the avoid traffic function auto/manual. (→P.112)
- C** Select to set the usage of traffic information for the estimated arrival time on/off.
- D** Select to set the display of an arrow of free flowing traffic on/off.
- E** Select to set to on/off whether to consider the predictive traffic information (→P.82) with estimated arrival time and detoured route search.
- F** Select to set traffic incident voice warning on/off.
- G** Select to reset all setup items.

### My traffic routes

Specific routes (such as frequently used routes) on which

you wish to receive traffic information can be registered as “My Traffic Routes”. A route is set by defining a start point and end point, and can be adjusted by setting up to 2 preferred roads.

- 1** Display the traffic settings screen. (→P.109)
- 2** Select “My Traffic Routes”.
- 3** Select the desired item.

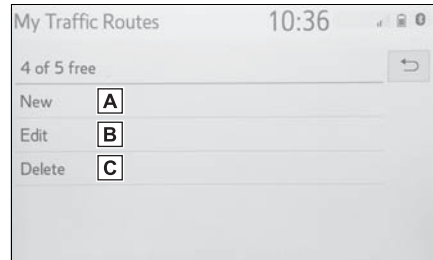

- A** Select to register personal traffic routes. (→P.110)
- B** Select to edit personal traffic routes. (→P.110)
- C** Select to delete personal traffic routes. (→P.111)

### Registering personal traffic routes

- 1** Select “New”.
- 2** Select “Name”.
- 3** Enter the name and select “OK”.
- 4** Select “Start”.
- 5** Select the desired item to search for the location. (→P.84)
- 6** Select “End”.

- 7** Select the desired item to search for the location.  
(→P.84)
- 8** Select “OK”.
- 9** Confirm the route overview displayed.



- A** Select the desired route from 3 possible routes. (→P.92)
  - B** Select to modify the route.  
The routes can be adjusted by setting preferred roads.  
(→P.111)
- 10** Select “OK”.

● Up to 5 routes can be registered.

### Editing personal traffic routes

- 1** Select “Edit”.
- 2** Select the desired traffic route.

- 3** Select the desired item to be edited.

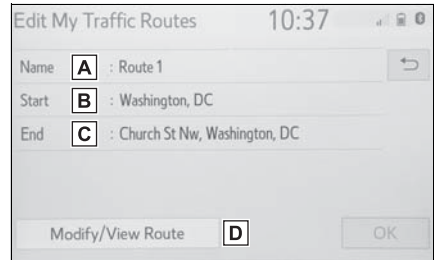

- A** Select to edit the name of the personal traffic route.  
(→P.110)
  - B** Select to edit start location.  
(→P.110)
  - C** Select to edit end location.  
(→P.110)
  - D** Select to see and modify the entire route. (→P.111)
- 4** Select “OK”.
  - 5** Follow the steps in “Registering personal traffic routes” from step **9**. (→P.110)

### Deleting personal traffic routes

- 1** Select “Delete”.
- 2** Select the desired traffic route to be deleted and select “Delete”.
- 3** Select “Yes” when the confirmation screen appears.

### Setting preferred roads

“My Traffic Routes” can be

adjusted by setting up to 2 preferred roads.

- 1 Select “Set Preferred Roads”.

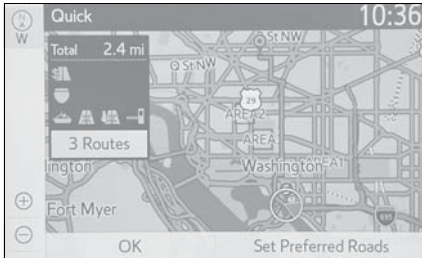

- 2 Select the desired item.

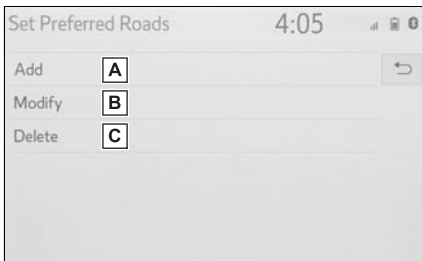

- A** Select to add preferred roads. (→P.111)
- B** Select to modify preferred roads. (→P.112)
- C** Select to delete preferred roads. (→P.112)

### ■ Adding preferred roads

- 1 Select “Add”.
- 2 Scroll the map to the desired point (→P.75) and select “OK”.
- 3 Select “OK” to use this road.

“Next”: Select to change road.

- ▶ Available only when 1 preferred road is set
- 4 Select “Add” for the desired location.

- If a preferred road is already set, a second preferred road can be added anywhere between the start point, the end point and the existing preferred road.

### ■ Modifying preferred roads

- 1 Select “Modify”.
- 2 Select the desired preferred road to be modified if 2 preferred roads have been set.
- 3 Scroll the map to the desired point (→P.75) and select “OK”.
- 4 Select “OK” to use this road.

“Next”: Select to change road.

### ■ Deleting preferred roads

- 1 Select “Delete”.
- 2 Select the desired preferred road to be deleted if 2 preferred roads have been set.

“Delete All”: Select to delete all preferred roads on the list.

- 3 Select “Yes” when the confirmation screen appears.

### Avoid traffic

- 1 Display the traffic settings screen. (→P.109)
- 2 Select “Avoid Traffic”.

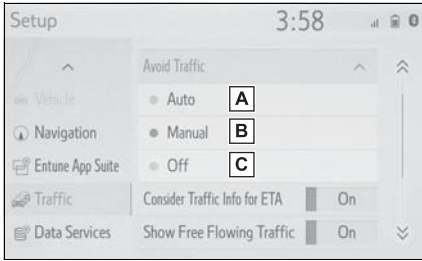
**3** Select the desired item.

- A** Select to automatically change routes when congestion information of the guidance route has been received.
- B** Select to select manually whether or not to change routes when congestion information of the guidance route has been received. In this mode, a screen will appear to ask if you wish to reroute.
- C** Select to not reroute when congestion information for the guidance route has been received.

### Changing the route manually

When the navigation system calculates a new route, a confirmation screen will be displayed.

**1** Select the desired item.

- A** Select to start route guidance using the new route.
- B** Select to confirm the new route and current route on the map.
- C** Select to continue the current route guidance.

## Use of information accumulated by navigation system\*

\*: This function may not be available immediately after purchase of the vehicle.

**When enabled, information collected by the navigation system will be analyzed to give advice for safe driving.**

## Displaying the useful navigation information settings screen

- 1 Press the “MENU” button.

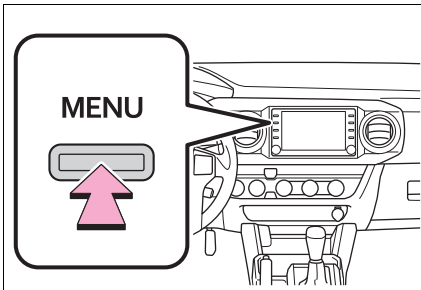

- 2 Select “Setup”.
- 3 Select “Navigation”.
- 4 Select “Useful Navi. Information Settings”.
- 5 Select the desired items to be set.

## GPS (Global Positioning System)

**This navigation system calculates the current position using satellite signals, various vehicle signals, map data, etc. However, an accurate position may not be shown depending on satellite conditions, road configuration, vehicle condition or other circumstances.**

### Limitations of the navigation system

The Global Positioning System (GPS) developed and operated by the U.S. Department of Defense provides an accurate current position, normally using 4 or more satellites, and in some case 3 satellites. The GPS system has a certain level of inaccuracy. While the navigation system compensates for this most of the time, occasional positioning errors of up to 300 ft. (100 m) can and should be expected. Generally, position errors will be corrected within a few seconds.

When the vehicle is not receiving signals from satellites, the unreceived GPS mark appears on the map screen. When the vehicle is receiving the signals, the unreceived GPS mark does

not appear on the map screen.

The GPS signal may be physically obstructed, leading to inaccurate vehicle position on the map screen. Tunnels, tall buildings, trucks, or even the placement of objects on the instrument panel may obstruct the GPS signals.

The GPS satellites may not send signals due to repairs or improvements being made to them.

Even when the navigation system is receiving clear GPS signals, the vehicle position may not be shown accurately or inappropriate route guidance may occur in some cases.



#### NOTICE

- The installation of window tinting may obstruct the GPS signals. Most window tinting contains some metallic content that will interfere with GPS signal reception of the antenna in the instrument panel. We advise against the use of window tinting on vehicles equipped with navigation systems.
- Accurate current position may not be shown in the following cases:
  - When driving on a small angled Y-shaped road.
  - When driving on a winding road.
  - When driving on a slippery road such as in sand, gravel, snow, etc.



- When driving on a long straight road.
- When freeway and surface streets run in parallel.
- After moving by ferry or vehicle carrier.
- When a long route is searched during high speed driving.
- When driving without setting the current position calibration correctly.
- After repeating a change of direction by going forward and backward, or turning on a turntable in a parking lot.
- When leaving a covered parking lot or parking garage.
- When a roof carrier is installed.
- When driving with tire chains installed.
- When the tires are worn.
- After replacing a tire or tires.
- When using tires that are smaller or larger than the factory specifications.
- When the tire pressure in any of the 4 tires is not correct.
- If the vehicle cannot receive GPS signals, the current position can be adjusted manually. For information on setting the current position calibration: →P.108
- Inappropriate route guidance may occur in the following cases:
  - When turning at an intersection off the designated route guidance.
  - If you set more than 1 destination but skip any of them, auto reroute will display a route returning to the destination on the previous route.
  - When turning at an intersection for which there is no route guidance.
  - When passing through an intersection for which there is no route guidance.
  - During auto reroute, the route guidance may not be available for the next turn to the right or left.
  - During high speed driving, it may take a long time for auto reroute to operate. In auto reroute, a detour route may be shown.
  - After auto reroute, the route may not be changed.
  - If an unnecessary U-turn is shown or announced.
  - If a location has multiple names and the system announces 1 or more of them.
  - When a route cannot be searched.
  - If the route to your destination includes gravel, unpaved roads or alleys, the route guidance may not be shown.
  - Your destination point might be shown on the opposite side of the street.
  - When a portion of the route has regulations prohibiting the entry of the vehicle that vary by time, season or other reasons.
  - The road and map data stored in the navigation system may not be complete or may not be the latest

version.

- After replacing a tire: →P.108
- 
- This navigation system uses tire turning data and is designed to work with factory-specified tires for the vehicle. Installing tires that are larger or smaller than the originally equipped diameter may cause inaccurate display of the current position. The tire pressure also affects the diameter of the tires, so make sure that the tire pressure of all 4 tires is correct.

## Map database version and covered area

Coverage areas and legal information can be displayed and map data can be updated.

## Map information

- 1 Select  on the map screen. (→P.72)
- 2 Select “Map Data”.
- 3 Check that the map data screen is displayed.

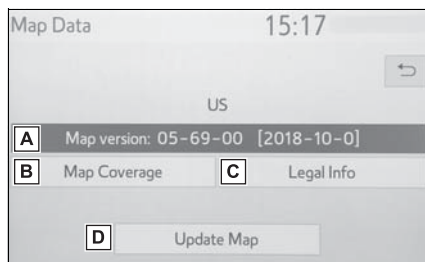

- A** Map version
- B** Select to display map coverage areas.
- C** Select to display legal information.
- D** Select to update map.

- For map data updates, contact your Toyota dealer.

## Temporary updates of the map\*

\*: This function is not made avail-

able in some countries or areas.

If the map data has been provided from the Cloud for any of the following areas and the map data in the navigation system is older than what has been provided, the displayed map will be updated temporarily:

- Areas around the area displayed on the map screen (example: areas around current position)
  - Areas around destinations
  - Areas along the set route
- 
- The updated data will temporarily be saved in the navigation system.
  - If temporary update data exceeds the available memory in the temporary map cache, the oldest data will be deleted.
  - The temporary map data will disappear when the expiration date has passed.



# Audio/visual system

## 4

### 4-1. Basic operation

Quick reference..... **120**

Some basics ..... **121**

### 4-2. Radio operation

AM/FM/SiriusXM<sup>®</sup> Satellite  
Radio..... **125**

Internet radio ..... **133**

### 4-3. Media operation

USB memory..... **134**

iPod/iPhone (Apple Car-  
Play)..... **136**

Android Auto ..... **139**

Bluetooth<sup>®</sup> audio ..... **140**

### 4-4. Audio/visual remote con- trols

Steering switches ..... **144**

### 4-5. Setup

Audio settings ..... **145**

### 4-6. Tips for operating the audio/visual system

Operating information : **147**

**Quick reference****Functional overview**

The audio control screen can be reached by the following methods:

- ▶ From the “AUDIO” button
  - 1 Press the “AUDIO” button.
- ▶ From the “MENU” button
  - 1 Press the “MENU” button, then select “Audio”.



- Using the radio (→P.125)
- Playing a USB memory (→P.134)
- Playing an iPod/iPhone (Apple CarPlay<sup>\*</sup>) (→P.136)
- Using the Android Auto<sup>\*</sup> (→P.139)
- Playing a Bluetooth<sup>®</sup> device (→P.140)
- Using the steering wheel audio switches (→P.144)
- Audio system settings (→P.145)

\*: This function is not made available in some countries or areas.

## Some basics

This section describes some of the basic features of the audio/visual system. Some information may not pertain to your system.

Your audio/visual system works when the engine switch is in ACC or ON.

### ⚠ NOTICE

- To prevent the 12-volt battery from being discharged, do not leave the audio/visual system on longer than necessary when the engine is not running.

## Turning the system on and off

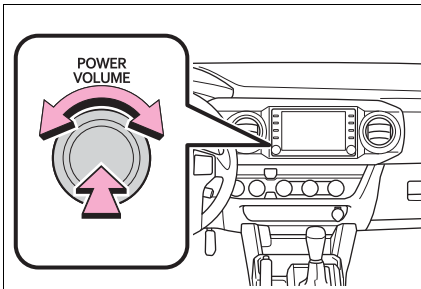

**“POWER VOLUME” knob:**  
Press to turn the audio/visual system on and off. The system turns on in the last mode used. Turn this knob to adjust the volume.

## Selecting an audio source

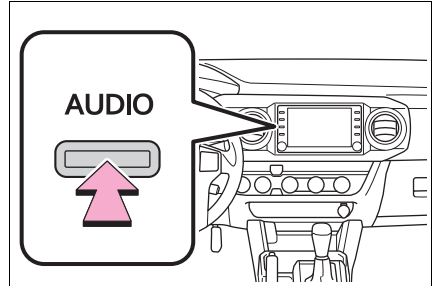

- 1 Press the “AUDIO” button.

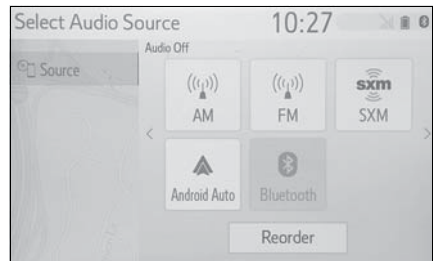

- 2 Select “Source” or press “AUDIO” button again.
- 3 Select the desired source.



- Dimmed screen buttons cannot be operated.

- When there are two pages, select  or  to change the page.

- When an Apple CarPlay/Android Auto connection is established, some system functions, such as the following, will be replaced by similar Apple CarPlay/Android Auto function or will become unavailable\*:

- iPod (Audio Playback)
- USB audio/USB video
- Bluetooth® audio
- Toyota apps

\*: This function is not made available in some countries or areas.

## Reordering the audio source

- 1 Display the audio source selection screen. (→P.121)
- 2 Select “Reorder”.
- 3 Select the desired audio source then < or > to reorder.
- 4 Select “OK”.

## USB port

- 1 Open the cover and connect a device.

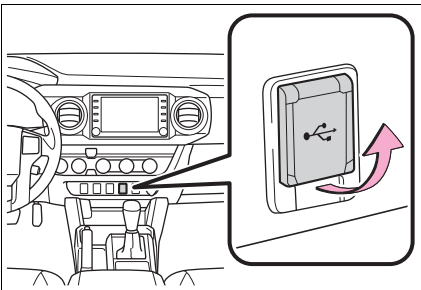

- Turn on the power of the device if it is not turned on.
- 
- If a USB hub is plugged-in, two devices can be connected at a time.
  - Even if a USB hub is used to connect more than two USB devices, only the first two connected devices will be recognized.
  - If a USB hub that has more than two ports is connected to the USB port, devices connected to the USB hub may not charge or be inoperable, as the supply of current may be insufficient.

## Sound settings

- 1 Display the audio control screen. (→P.121)
- 2 Select “Sound”.
- 3 Select the desired item to be set.

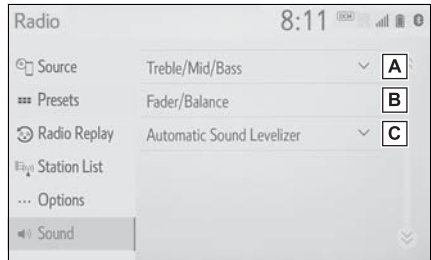

- A** Select to set the treble/mid/bass. (→P.122)
- B** Select to set the fader/balance. (→P.123)
- C** Select to set the automatic sound levelizer. (→P.123)

### ■ Treble/Mid/Bass

How good an audio program sounds is largely determined by the mix of the treble, mid and bass levels. In fact, different kinds of music and vocal programs usually sound better with different mixes of treble, mid and bass.

- 1 Select “Treble/Mid/Bass”.



- 2 Select the desired screen button.

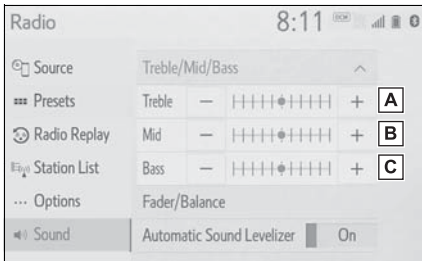

- A** Select “+” or “-” to adjust high-pitched tones.
- B** Select “+” or “-” to adjust mid-pitched tones.
- C** Select “+” or “-” to adjust low-pitched tones.

#### ■ Fader/Balance

A good balance of the left and right stereo channels and of the front and rear sound levels is also important.

Keep in mind that when listening to a stereo recording or broadcast, changing the right/left balance will increase the volume of 1 group of sounds while decreasing the volume of another.

- 1 Select “Fader/Balance”.

- 2 Select the desired screen button.

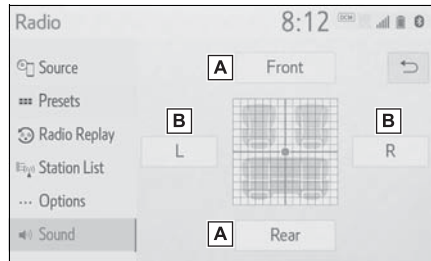

- A** Select to adjust the sound balance between the front and rear speakers.
- B** Select to adjust the sound balance between the left and right speakers.

#### ■ Automatic sound levelizer (ASL)

The system adjusts to the optimum volume and tone quality according to vehicle speed to compensate for increased road noise, wind noise, or other noises while driving.

- 1 Select “Automatic Sound Levelizer”.
- 2 Select “High”, “Mid”, “Low” or “Off”.

### Audio screen adjustment

#### ■ Screen format settings

The screen format can be selected for USB video.

- 1 Press the “MENU” button.
- 2 Select “Setup”.
- 3 Select “Audio”.

- 4 Select "Common".
- 5 Select "Screen Format".
- 6 Select the desired item to be adjusted.

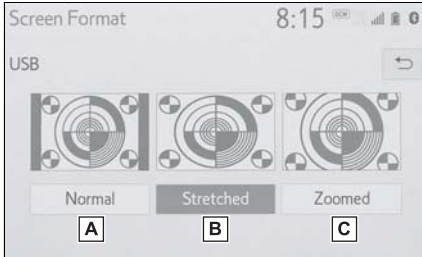

- A** Select to display a 4:3 screen, with either side in black.
- B** Select to enlarge the image horizontally and vertically to full screen.
- C** Select to enlarge the image by the same ratio horizontally and vertically.

**■ Contrast and brightness adjustment**

The contrast and brightness of the screen can be adjusted.

- 1 Press the "MENU" button.
- 2 Select "Setup".
- 3 Select "Audio".
- 4 Select "Common".
- 5 Select "Display".
- 6 Select the desired item to be adjusted.

● "Contrast"

"+": Select to strengthen the contrast of the screen.

"-": Select to weaken the contrast of the screen.

● "Brightness"

"+": Select to brighten the screen.

"-": Select to darken the screen.

- Depending on the audio source, some functions may not be available.

**Voice command system**

- 1 Press this switch to operate the voice command system.

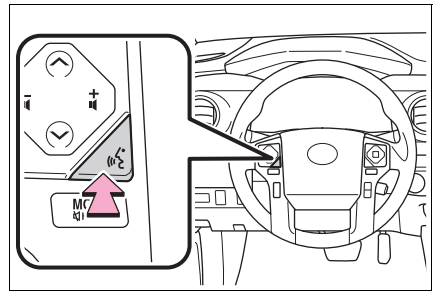

- The voice command system and its list of commands can be operated. (→P.158)

## AM/FM/SiriusXM® Satellite Radio\*

\*: This function is not made available in some countries or areas.

### Overview

The radio operation screen can be reached by the following methods:

→P.121

### Control screen

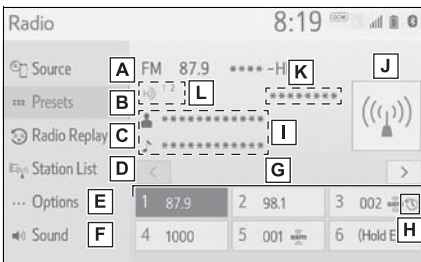

- A** Select to display the audio source selection screen.
- B** Select to display the preset stations screen. (→P.126)
- C** Select to display the cache radio operation screen.\* (→P.126)
- D** Select to display a list of receivable stations. (→P.127)
- E** Select to display the radio options screen. (→P.127)
- F** Select to display the sound setting screen. (→P.122)
- G** Select to tune to preset sta-

tions/channels. (→P.126)

- H** Displays items on the channels registered to smart favorites\* (→P.131, 146)
- I** Displays the artist info and song title or album  
Select to change the displayed information.  
Displays messages when available\*
- J** Displays cover art, station logo, etc.\*
- K** Displays information about the song/track currently being played\*
- L** Select to display HD) multi-cast channels available.\* (→P.129)

\*: This function is not made available in some countries or areas.

### Control panel

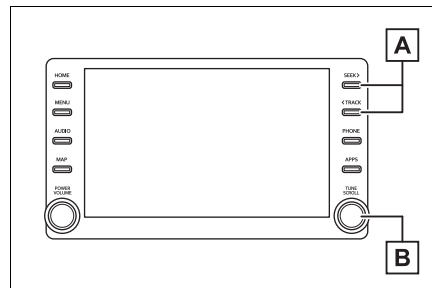

- A** Press to seek for stations in the relevant program type/channel category.  
Press and hold for continuous seek.

- B** Turn to step up/down frequencies/channels.  
Turn to move up/down the station list. Also, the knob can be used to enter selections on the list screens by pressing it.

- The radio automatically changes to stereo reception when a stereo broadcast is received.
- The radio automatically blends to an HD Radio signal in AM or FM where available.

### Presetting a station

Radio mode has a mix preset function, which can store up to 36 stations (6 stations per page x 6 pages) from any of the AM, FM or SXM bands.

- 1 Tune in the desired station.
- 2 Select and hold “(Hold Edit)”.

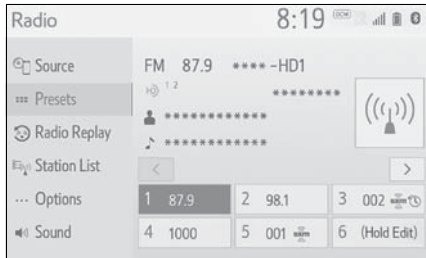

- To change the preset station to a different one, select and hold the preset station.
- The number of preset radio stations displayed on the screen can be changed. (→P.145)

### Caching a radio program\*

\*: This function is not made available in some countries or areas.

AM/FM\* and SXM radio program can be cached and played back in a time-shifted manner.

\*: Premium Audio only

#### ■ Automatic playback of the cache

If the radio broadcast is interrupted by another audio output, such as an incoming phone call, the system will automatically cache the interrupted portion and perform time-shift playback when the interruption ends. This function is available when “Auto Pause” is set to on. (→P.127)

#### ■ Playing back the cache manually

The broadcast cached in the program cache can be played back manually.

- 1 Select “SXM Replay”<sup>\*1</sup> or “Radio Replay”<sup>\*2</sup>.

\*1: Audio with SiriusXM<sup>®</sup> Satellite Radio

\*2: Premium Audio

- 2** Select the desired cache radio operation button.

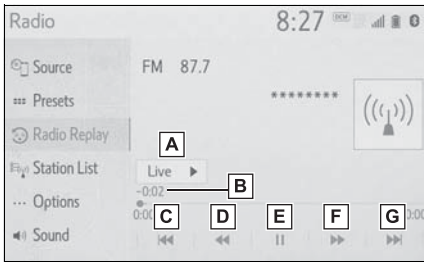

- A** Returns to the live radio broadcast
- B** Displays the replay offset from the current time
- C** Skips backward 2 minutes (AM/FM)  
Select to select current/previous track (SXM)
- D** Fast rewinds continuously
- E** Pauses the playback (To restart, select )
- F** Fast forwards continuously
- G** Skips forward 2 minutes (AM/FM)  
Select to change the track (SXM)

- The system can store up to 20 minutes of AM/FM and less than 60 minutes of SXM. Cached data will be erased when the radio mode or station is changed or when the audio system is turned off.
- AM/FM: If noise or silence occurs during the caching process, cache writing will continue, with the noise or silence recorded as is. In this case, the cached broadcast will

contain the noise or silence when played back.

## Selecting a station from the list

- 1** Select “Station List”.
- 2** Select “AM”, “FM” or “SXM”.
- Select the desired program genre when the genre selection screen is displayed.
- 3** Select the desired station.

## ■ Refreshing the station list (AM/FM)

- 1** Select “Station List”.
- “Cancel Refresh”: Select to cancel the refresh.
- “Source”: Select to change to another audio source while refreshing.

- The audio/visual system sound is muted during refresh operation.
- In some situations, it may take some time to update the station list.

## Radio options

- 1** Select “Options”.
- 2** Select the desired item to be set.



- A** Select to turn automatic playback of the cache on/off.\*
- B** When “SXM Tune Start” is turned on, the current song is played from the beginning when you select the channel.\*
- C** Select to turn digital AM Radio mode on/off.\*
- D** Select to turn digital FM Radio mode on/off.\*
- E** Analog FM only: Select to display RBDS text messages.
- F** Select to scan for receivable stations. (Type scan in case SXM is current program type/channel category.)

\*: This function is not made available in some countries or areas.

### Radio broadcast data system

This audio/visual system is equipped with Radio Broadcast Data Systems (RBDS). RBDS mode allows text messages to be received from radio stations that utilize RBDS transmitters.

When RBDS is on, the radio can do the following functions.

- Only selecting stations of a particular program type
- Displaying messages from radio stations

- Searching for a stronger signal station

RBDS features are available only when listening to an FM station that broadcasts RBDS information and the “FM Info” function is on. (→P.127)

### Using HD Radio™ technology\*

\*: This function is not made available in some countries or areas.

HD Radio™ Technology is the digital evolution of analog AM/FM radio. Your radio product has a special receiver which allows it to receive digital broadcasts (where available) in addition to the analog broadcasts it already receives. Digital broadcasts have better sound quality than analog broadcasts as digital broadcasts provide free, crystal clear audio with no static or distortion. For more information, and a guide to available radio stations and programming, refer to [www.hdradio.com](http://www.hdradio.com).

HD Radio features included in Toyota radios:

- Digital Sound-  
HD Radio broadcasts deliver crystal-clear, digital audio quality to listeners.
- HD2/HD3 Channels-  
FM stations can provide additional digital only audio programming with expanded

content and format choices on HD2/HD3 channels.

- PSD- Program Service Data (PSD) gives you on-screen information such as artist name and song title.
- Artist Experience- Images related to the broadcast are displayed on the radio screen, such as album cover art and station logos.

#### ■ Certification



HD Radio Technology manufactured under license from iBiquity Digital Corporation. U.S. and Foreign Patents. For patents see <http://dts.com/patents>. HD Radio, Artist Experience, and the HD, HD Radio, and "ARC" logos are registered trademarks or trademarks of iBiquity Digital Corporation in the United States and/or other countries.

#### Available HD Radio™ technology

##### ■ Multicast

On the FM radio frequency most digital stations have "multiple" or supplemental programs on one FM station.

1 Select .

2 Select the desired channel.

- Turning the "TUNE SCROLL" knob can also select the desired multicast channel.

#### Troubleshooting guide

##### ■ Experience

- Mismatch of time alignment- a user may hear a short period of programming replayed or an echo, stutter or skip.

Cause: The radio stations analog and digital volume is not properly aligned or the station is in ballgame mode.

Action: None, radio broadcast issue. A user can contact the radio station.

- Sound fades, blending in and out.

Cause: Radio is shifting between analog and digital audio.

Action: Reception issue, may clear-up as the vehicle continues to be driven. Turning the indicator of the "HD Radio AM" and "HD Radio FM" button off can force radio in an analog audio.

- Audio mute condition when an HD2/HD3 multicast channel had been playing.

Cause: The radio does not have access to digital signals at the moment.

Action: This is normal behavior, wait until the digital signal returns. If out of the coverage area, seek a new station.

- Audio mute delay when selecting an HD2/HD3 multicast channel preset.

Cause: The digital multicast content is not available until HD Radio™ broadcast can be decoded and make the audio available. This takes up to 7 seconds.

Action: This is normal behavior, wait for the audio to become available.

- Text information does not match the present song audio.

Cause: Data service issue by the radio broadcaster.

Action: Broadcaster should be notified. Complete the form: [hdradio.com/stations/feedback](http://hdradio.com/stations/feedback).

- No text information shown for the present selected frequency.

Cause: Data service issue by the radio broadcaster.

Action: Broadcaster should be notified. Complete the form: [hdradio.com/stations/feedback](http://hdradio.com/stations/feedback).

### **How to Subscribe to SiriusXM Satellite Radio\***

\*: This function is not made available in some countries or areas.

All SiriusXM services, including satellite radio and data services, plus streaming services, require a subscription, sold separately or as a package by Sirius XM Radio Inc. (U.S.A.) or Sirius XM Canada Inc. (Canada), after any

trial subscription which may be included with your vehicle purchase or lease. To subscribe after your trial subscription, call 1-877-447-0011 (U.S.A.) or 1-877-438-9677 (Canada).

### **■ Important information about your subscription**

Your SiriusXM services will automatically stop at the end of your trial unless you decide to subscribe. If you decide to continue service, the paid subscription plan you choose will automatically renew and you will be charged the rate in effect at that time and according to your chosen payment method. Fees and taxes apply. You may cancel at any time by calling 1-866-635-2349. See SiriusXM Customer Agreement for complete terms at [www.siriusxm.com](http://www.siriusxm.com) (U.S.A.) or [www.siriusxm.ca](http://www.siriusxm.ca) (Canada). All fees and programming subject to change. Traffic information not available in all markets.



**NOTICE**

- It is prohibited to copy, decompile, disassemble, reverse engineer, hack, manipulate, or otherwise make available any technology or software incorporated in receivers compatible with the SiriusXM Satellite Radio System or that support the SiriusXM website, the streaming service or any of its content. Furthermore, the AMBE<sup>®</sup> voice compression software included in this product is protected by intellectual property rights including patent rights, copyrights, and trade secrets of Digital Voice Systems, Inc.
- Note: this applies to SiriusXM Satellite Radio receivers only and not SiriusXM Ready devices.

- About SiriusXM Services
  - Most in-car trials today include SiriusXM's best package — All Access. It includes every channel available on your radio, plus streaming.
- SiriusXM All Access subscription
  - Listen everywhere with All Access. You get every channel available in your ride, plus you can listen on the app and online — so you can enjoy the best SiriusXM has to offer, anywhere life takes you. It's the only package that gives you all of our premium programming, including Howard Stern, every NFL, MLB<sup>®</sup> and NBA game, every NASCAR<sup>®</sup> race, NHL<sup>®</sup> games, 24/7 talk channels dedicated to the biggest leagues, and more. You get all kinds of commercial-free music, including artistdedicated channels and more, plus sports, news, talk and entertainment.
- SiriusXM radio operation

- Look for the Sirius, XM, SiriusXM, Band, SAT, Radio or Source button and you're in. If you can't hear us, it's easy to get started:
  - U.S.A.:
    - Locate your Radio ID by turning to Channel 0. If you don't see your number there, go to [siriusxm.com/activationhelp](http://siriusxm.com/activationhelp) to find it.
    - Visit [siriusxm.com/refresh](http://siriusxm.com/refresh) or call 1-855-MYREFRESH (697-3373) to send a refresh signal to your radio.
  - Canada:
    - Locate your Radio ID by turning to Channel 0.
    - Visit [siriusxm.ca/refresh](http://siriusxm.ca/refresh) to send a refresh signal to your radio or call 1-888-539-7474 for service.

**Displaying the radio ID**

Each SiriusXM tuner is identified with a unique radio ID. The radio ID is required when activating an SiriusXM Satellite service or when reporting a problem.

- If "Ch 000" is selected using the "TUNE SCROLL" knob, the ID code, which is 8 alphanumeric characters, will be displayed. If another channel is selected, the ID code will no longer be displayed. The channel (000) alternates between displaying the radio ID and the specific radio code.

**Smart favorites**

Up to 20 channels can be registered as presets in the cache. For channel registration, refer to (→P.145).

- 1** Select channels registered to smart favorites.
- 2** Select “SXM Replay”<sup>\*1</sup> or “Radio Replay”<sup>\*2</sup>.

<sup>\*1</sup>: Audio with SiriusXM® Satellite Radio

<sup>\*2</sup>: Premium Audio

- Caches up to 30 minutes for each Smart Favorite preset.

- The radio plays the track from start when that track has not previously been heard by the user and the station is registered as a smart favorite.
- When “SXM Tune Start” is turned on (→P.127), the current song is played from the beginning when you select the channel.
- Displays icons on the channels registered to smart favorites. (→P.125)

**Refer to the table below to identify the problem and take the suggested corrective action**

When problems occur with the SiriusXM tuner, a message will appear on the screen. Referring to the table below to identify the problem, take the suggested corrective action.

Message	Explanation
“Check Antenna”	The SiriusXM antenna is not connected. Check whether the SiriusXM antenna cable is attached securely. Contact your Toyota dealer for assistance.
	A short circuit occurs in the antenna or the surrounding antenna cable. Contact your Toyota dealer for assistance.
“No Signal”	The SiriusXM signal is too weak at the current location. Wait until your vehicle reaches a location with a stronger signal.
“Chan Unavailable”	The channel you selected is not broadcasting any programming. Select another channel.
“Ch Unsubscribed”	The channel you selected is no longer available. Wait for about 2 seconds until the radio returns to the previous channel or “Ch 001”. If it does not change automatically, select another channel.
“Subscription Updated”	Subscription is updated. Select “OK” to clear this message.

- Contact the SiriusXM Listener Care Center at 1-877-447-0011 (U.S.A.) or 1-877-438-9677 (Canada).

## Internet radio \*

\*: This function is not made available in some countries or areas.

**One of Toyota apps features is the ability to listen to internet radio. In order to use this service, a compatible phone and the system needs to be set up. For details: →P.289**

## Listening to internet radio

- 1 Display the audio source selection screen. (→P.121)
  - 2 Select the desired application screen button.
    - The internet radio application screen is displayed.
    - Perform operations according to the displayed application screen.
    - For the instrument panel operation method: →P.121
    - If a compatible phone is already registered, it will be connected automatically.
- 
- Other applications can be activated while listening to internet radio.
  - Some parts of applications can be adjusted using the switches on the steering wheel.
  - For additional information, refer to <https://www.toyota.com/audio-multimedia> or call 1-800-331-4331 in the United States, <https://www.toyota.ca/connected>

or call  
1-888-869-6828 in Canada, and  
<http://www.toyotapr.com/audio-multimedia> or call  
1-877-855-8377 in Puerto Rico.

## USB memory

### Overview

The USB memory operation screen can be reached by the following methods: →P.121

- Connecting a USB memory (→P.122)
- When an Apple CarPlay/Android Auto connection is established, this function will be unavailable.

### Control screen

#### ▶ USB audio

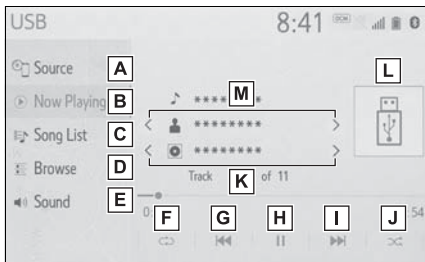

- A** Select to display the audio source selection screen.
- B** Select to return to the top screen.
- C** Select to display a song list screen.
- D** Select to display the play mode selection screen.
- E** Select to display the sound setting screen. (→P.122)
- F** Select to set repeat playback. (→P.135)

- G** Select to change the file/track.  
Select and hold to fast rewind.
- H** Select to play/pause.
- I** Select to change the file/track.  
Select and hold to fast forward.
- J** Select to set random playback. (→P.135)
- K** Select to change the folder/album.
- L** Displays cover art
- M** Select to change the artist.

#### ▶ USB video

- 1 Select "Browse".
- 2 Select "Videos".
- 3 Select the desired folder and file.

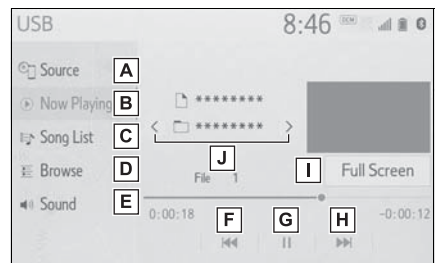

- A** Select to display the audio source selection screen.
- B** Select to return to the top screen.
- C** Select to display a song list screen.

- D** Select to display the play mode selection screen.
- E** Select to display the sound setting screen. (→P.122)
- F** Select to change the file.  
Select and hold to fast rewind.
- G** Select to play/pause.
- H** Select to change the file.  
Select and hold to fast forward.
- I** Select to display a full screen image.
- J** Select to change the folder.

### Control panel

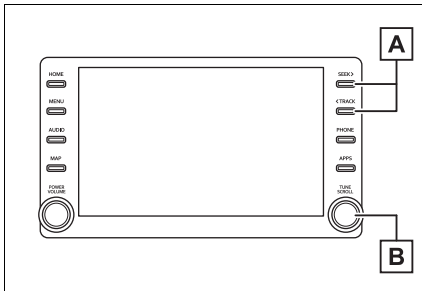

- A** Press to change the file/track.  
Press and hold to fast forward/rewind.
- B** Turn to change the file/track.  
Turn to move up/down the list. Also, the knob can be used to enter selections on the list screens by pressing it.

this function can only output sound.

- If tag information exists, the file/folder names will be changed to track/album names.

### Repeating

The file/track or folder/album currently being listened to can be repeated.

- 1 Select .

- Each time  is selected, the mode changes as follows:
  - ▶ When random playback is off
    - file/track repeat → folder/album repeat → off
  - ▶ When random playback is on
    - file/track repeat → off

### Random order

Files/tracks or folders/albums can be automatically and randomly selected.

- 1 Select .

- Each time  is selected, the mode changes as follows:
  - random (1 folder/album random) → folder/album random (all folder/album random) → off

### WARNING

- Do not operate the player's controls or connect the USB memory while driving.

- While the vehicle is being driven,



**NOTICE**

- Do not leave your portable player in the car. In particular, high temperatures inside the vehicle may damage the portable player.
- Do not push down on or apply unnecessary pressure to the portable player while it is connected as this may damage the portable player or its terminal.
- Do not insert foreign objects into the port as this may damage the portable player or its terminal.

## iPod/iPhone (Apple CarPlay\*)

\*: This function is not made available in some countries or areas.

### Overview

The iPod/iPhone operation screen can be reached by the following methods: →P.121

- Connecting an iPod/iPhone (→P.122)
- When an Android Auto connection is established, this function will be unavailable.

### Control screen

- ▶ An Apple CarPlay connection is not established

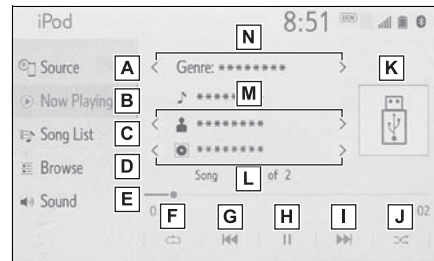

- ▶ An Apple CarPlay connection is established

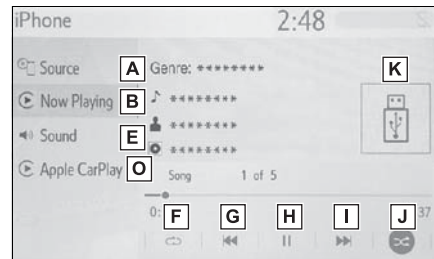

- A** Select to display the audio source selection screen.
- B** Select to return to the top screen.
- C** Select to display a song list screen.
- D** Select to display the play mode selection screen.
- E** Select to display the sound setting screen. (→P.122)
- F** Select to set repeat playback. (→P.138)
- G** Select to change the track. Select and hold to fast rewind.
- H** Select to play/pause.
- I** Select to change the track. Select and hold to fast forward.
- J** Select to set random playback. (→P.138)
- K** Displays cover art
- L** Select to change the album.
- M** Select to change the artist.
- N** Select to change the playlist.
- O** Select to display the audio control screen of Apple Car-Play.

### Control panel

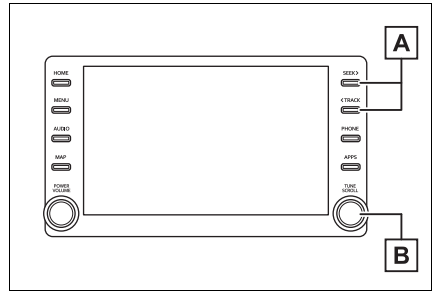

- A** Press to change the track. Press and hold to fast forward/rewind.
- B** Turn to change the track. Turn to move up/down the list. Also, the knob can be used to enter selections on the list screens by pressing it.

- Some functions may not be available depending on the type of model.
- When an iPod/iPhone is connected using a genuine iPod/iPhone cable, the iPod/iPhone starts charging its battery.
- Depending on the iPod/iPhone, the video sound may not be able to be heard.
- Depending on the iPod/iPhone and the songs in the iPod/iPhone, a cover art may be displayed. This function can be changed to "On" or "Off". (→P.145) It may take time to display the cover art, and the iPod/iPhone may not be operated while the cover art display is in process.
- When an iPod/iPhone is connected and the audio source is changed to iPod/iPhone mode, the iPod/iPhone will resume playing from the same point it was last

used.

- Depending on the iPod/iPhone that is connected to the system, certain functions may not be available.
- If an iPhone is connected via Bluetooth® and USB at the same time, system operation may become unstable. For known phone compatibility information, refer to <https://www.toyota.com/audio-multimedia>.
- Tracks selected by operating a connected iPod/iPhone may not be recognized or displayed properly.
- The system may not function properly if a conversion adapter is used to connect a device.

### Repeating

The track currently being listened to can be repeated.

1 Select .

- Each time  is selected, the mode changes as follows:
  - ▶ When shuffle is off (iPhone 5 or later)
    - track repeat → album repeat → off
  - ▶ When shuffle is off (iPhone 4s or earlier)
    - track repeat → off
  - ▶ When shuffle is on
    - track repeat → off

### Random order

Tracks or albums can be automatically and randomly selected.

1 Select .

- Each time  is selected, the mode changes as follows:
  - shuffle (1 album shuffle) → album shuffle (all album shuffle) → off

#### WARNING

- Do not operate the player's controls or connect the iPod/iPhone while driving.

#### NOTICE

- Do not leave your portable player in the car. In particular, high temperatures inside the vehicle may damage the portable player.
- Do not push down on or apply unnecessary pressure to the portable player while it is connected as this may damage the portable player or its terminal.
- Do not insert foreign objects into the port as this may damage the portable player or its terminal.



## Android Auto \*

\*: This function is not made available in some countries or areas.

### Overview

The Android Auto operation screen can be reached by the following methods: →P.121

- Connecting an Android Auto (→P.122)
- When an Apple CarPlay connection is established, this function will be unavailable.

### Control screen

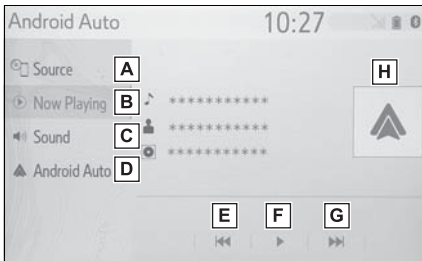

- A** Select to display the audio source selection screen.
- B** Select to return to the top screen.
- C** Select to display the sound setting screen. (→P.122)
- D** Select to display the audio control screen of Android Auto.
- E** Select to change the track.
- F** Select to play/pause.

- G** Select to change the track.
- H** Displays cover art

### Control panel

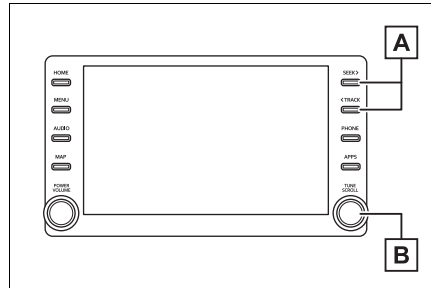

- A** Press to change the track.
- B** Turn to change the track.

### ⚠ WARNING

- Do not connect smartphone or operate the controls while driving.

### ⚠ NOTICE

- Do not leave your smartphone in the vehicle. In particular, high temperatures inside the vehicle may damage the smartphone.
- Do not push down on or apply unnecessary pressure to the smartphone while it is connected as this may damage the smartphone or its terminal.
- Do not insert foreign objects into the port as this may damage the smartphone or its terminal.

## Bluetooth® audio

The Bluetooth® audio system enables users to enjoy listening to music that is played on a portable player on the vehicle speakers via wireless communication.

This audio/visual system supports Bluetooth®, a wireless data system capable of playing portable audio music without cables. If your device does not support Bluetooth®, the Bluetooth® audio system will not function.

### Overview

The Bluetooth® audio operation screen can be reached by the following methods: →P.121

- Connecting a Bluetooth® audio device (→P.142)
- Depending on the type of portable player connected, some functions may not be available and/or the screen may look differently than shown in this manual.
- When an Apple Car-Play/Android Auto connection is established, Bluetooth® audio will be suspended and become unavailable.\*

\*: This function is not made available in some countries or areas.

### Control screen

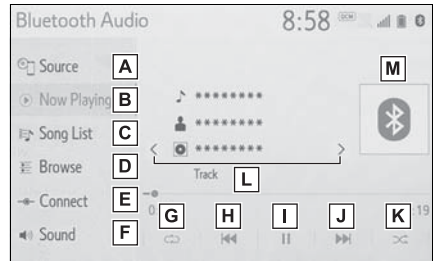

- A** Select to display the audio source selection screen.
- B** Select to return to the top screen.
- C** Select to display a song list screen.
- D** Select to display the play mode selection screen.
- E** Select to display the portable device connection screen. (→P.142)
- F** Select to display the sound setting screen. (→P.122)
- G** Select to set repeat playback. (→P.141)
- H** Select to change the track. Select and hold to fast rewind.
- I** Select to play/pause.
- J** Select to change the track. Select and hold to fast forward.
- K** Select to set random play-

back. (→P.141)

**L** Select to change the album.

**M** Displays cover art

### Control panel

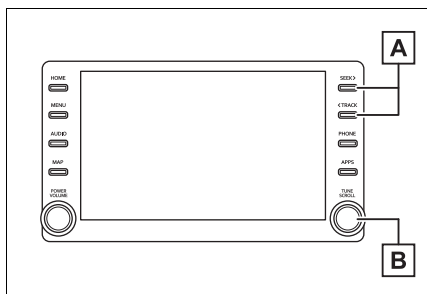

**A** Press to change the track.  
Press and hold to fast forward/rewind.

**B** Turn to change the track.  
Turn to move up/down the list. Also, the knob can be used to enter selections on the list screens by pressing it.

### Repeating

The track or album currently being listened to can be repeated.



**1** Select .

- Each time  is selected, the mode changes as follows:
  - ▶ When random playback is off
    - track repeat → album repeat → off
    - ▶ When random playback is on
      - track repeat → off

### Random order

Tracks or albums can be automatically and randomly selected.

**1** Select .

- Each time  is selected, the mode changes as follows:
  - random (1 album random) → album random (all album random) → off
- Depending on the Bluetooth<sup>®</sup> device that is connected to the system, the music may start playing when selecting  while it is paused. Conversely, the music may pause when selecting  while it is playing.
- In the following conditions, the system may not function:
  - The Bluetooth<sup>®</sup> device is turned off.
  - The Bluetooth<sup>®</sup> device is not connected.
  - The Bluetooth<sup>®</sup> device has a low battery.
- When using the Bluetooth<sup>®</sup> audio and Wi-Fi<sup>®</sup> hotspot functions at the same time, the following problems may occur:
  - It may take longer than normal to connect to the Bluetooth<sup>®</sup> device.
  - The sound may cut out.
  - It may take time to connect the phone when Bluetooth<sup>®</sup> audio is being played.
- For operating the portable player, see the instruction manual that comes with it.
- If the Bluetooth<sup>®</sup> device is disconnected due to poor reception from the Bluetooth<sup>®</sup> network when the

engine switch is in ACC or ON, the system automatically reconnects the portable player.

- If the Bluetooth® device is disconnected on purpose, such as it was turned off, this does not happen. Reconnect the portable player manually.
- Bluetooth® device information is registered when the Bluetooth® device is connected to the Bluetooth® audio system. When selling or disposing of the vehicle, remove the Bluetooth® audio information from the system. (→P.63)
- In some situations, sound output via the Bluetooth® audio system may be out of sync with the connected device or output intermittently.

 **WARNING**

- Do not operate the player's controls or connect to the Bluetooth® audio system while driving.
- Your audio unit is fitted with Bluetooth® antennas. People with implantable cardiac pacemakers, cardiac resynchronization therapy-pacemakers or implantable cardioverter defibrillators should maintain a reasonable distance between themselves and the Bluetooth® antennas. The radio waves may affect the operation of such devices.

● Before using Bluetooth® devices, users of any electrical medical device other than implantable cardiac pacemakers, cardiac resynchronization therapy-pacemakers or implantable cardioverter defibrillators should consult the manufacturer of the device for information about its operation under the influence of radio waves. Radio waves could have unexpected effects on the operation of such medical devices.

 **NOTICE**

- Do not leave your portable player in the vehicle. In particular, high temperatures inside the vehicle may damage the portable player.

**Registering/Connecting a Bluetooth® device**

To use the Bluetooth® audio system, it is necessary to register a Bluetooth® device with the system.

- ▶ Registering an additional device
  - 1 Display the Bluetooth® audio control screen. (→P.140)
  - 2 Select "Connect".
  - 3 Select "Add Device".
- When another Bluetooth® device is connected, a confirmation screen will be displayed. To disconnect the Bluetooth® device, select "Yes".

- 4 Follow the steps in “Registering a Bluetooth® phone for the first time” from step 5. (→P.36)
- ▶ Selecting a registered device
- 1 Display the Bluetooth® audio control screen. (→P.140)
- 2 Select “Connect”.
- 3 Select the desired device to be connected.
- 4 Check that a confirmation screen is displayed when the connection is complete.
- If an error message is displayed, follow the guidance on the screen to try again.

## Steering switches

### Steering switch operation

Some parts of the audio/visual system can be adjusted using the switches on the steering wheel.

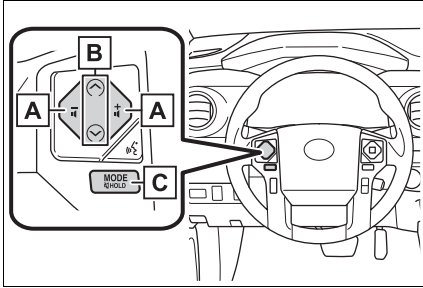

**A** Volume control switch

**B** SEEK/TRACK switch

**C** “MODE/HOLD” switch

#### ■ Volume control switch

- Press: Volume up/down
- Press and hold (0.8 sec. or more): Volume up/down continuously

#### ■ SEEK/TRACK switch

- ▶ AM/FM
- Press: Preset channel up/down
- Press and hold (0.8 sec. or more): Seek up/down
- Press and hold (1.5 sec. or more): Seek up/down continuously while the switch is being pressed
- ▶ SXM
- Press: Preset channel

up/down

- Press and hold (0.8 sec. or more): Seek for stations in the relevant program type/channel category
- Press and hold (1.5 sec. or more): Fast channel up/down
- ▶ USB, iPod/iPhone, Bluetooth® audio
- Press: Track/file up/down
- Press and hold (0.8 sec. or more): Fast forward/rewind
- ▶ Android Auto
- Press: Track up/down

#### ■ “MODE/HOLD” switch

- ▶ AM/FM/SXM
- Press: Change audio modes
- Press and hold (0.8 sec. or more): Mute/pause (Press and hold again to resume.)
- ▶ USB, iPod/iPhone, Bluetooth® audio, Android Auto, Toyota apps
- Press: Change audio modes
- Press and hold (0.8 sec. or more): Pause (Press and hold again to resume the play mode.)

## Audio settings

Detailed audio settings can be programmed.

### Displaying the audio settings screen

- 1 Press the “MENU” button.

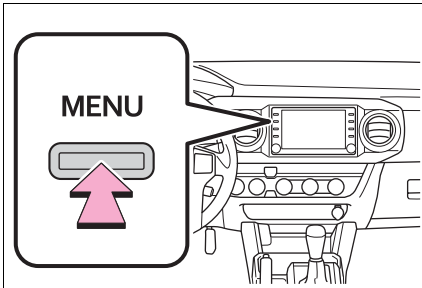

- 2 Select “Setup”.
- 3 Select “Audio”.
- 4 Select the desired items to be set.

### Audio settings screen

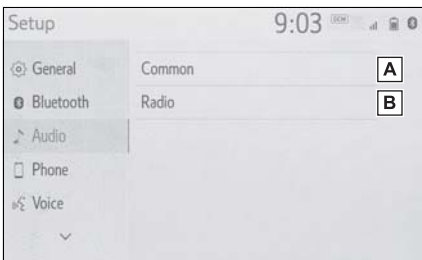

- A Select to set the common settings. (→P.145)
- B Select to set the radio settings. (→P.145)

## Common settings

- 1 Display the audio settings screen. (→P.145)
- 2 Select “Common”.
- 3 Select the desired items to be set.



- A Select to set the cover art display on/off.
- B Select to prioritize the display of information from the Gracenote database.
- C Select to change the screen size.\* (→P.123)
- D Select to display the image quality adjustment screen.\* (→P.124)

\*: Only in USB video mode

## Radio settings

- 1 Display the audio settings screen. (→P.145)
- 2 Select “Radio”.
- 3 Select the desired items to be set.



**A** Edit smart favorites.\*

(→P.146)

**B** Select to change the number of preset radio stations displayed on the screen.

(→P.146)

\*: If equipped

### Manage smart favorites

- 1 Select "Manage Smart Favorites".
- 2 Select the desired channel to be set.

- Displays the registered preset channels.
- Up to 20 channels can be registered.

### Setting the number of radio presets

- 1 Select "Number of Radio Presets".
- 2 Select the button with the desired number to be displayed.



## Operating information

- The use of a cellular phone inside or near the vehicle may cause a noise from the speakers of the audio/visual system which you are listening to. However, this does not indicate a malfunction.



### NOTICE

- To avoid damage to the audio/visual system:
  - Be careful not to spill beverages over the audio/visual system.

## Radio

Usually, a problem with radio reception does not mean there is a problem with the radio — it is just the normal result of conditions outside the vehicle.

For example, nearby buildings and terrain can interfere with FM reception. Power lines or phone wires can interfere with AM signals. And of course, radio signals have a limited range. The farther the vehicle is from a station, the weaker its signal will be. In addition, reception conditions change constantly as the vehicle moves.

Here are some common reception problems that may not indicate a problem with the radio as described.

### ■ FM

**Fading and drifting stations:**  
Generally, the effective range of

FM is about 25 miles (40 km). Once outside this range, you may notice fading and drifting, which increase with the distance from the radio transmitter. They are often accompanied by distortion.

**Multi-path:** FM signals are reflective, making it possible for 2 signals to reach the vehicle's antenna at the same time. If this happens, the signals will cancel each other out, causing a momentary flutter or loss of reception.

**Static and fluttering:** These occur when signals are blocked by buildings, trees or other large objects. Increasing the bass level may reduce static and fluttering.

**Station swapping:** If the FM signal being listened to is interrupted or weakened, and there is another strong station nearby on the FM band, the radio may tune in the second station until the original signal can be picked up again.

### ■ AM

**Fading:** AM broadcasts are reflected by the upper atmosphere — especially at night. These reflected signals can interfere with those received directly from the radio station, causing the radio station to sound alternately strong and weak.

**Station interference:** When a reflected signal and a signal received directly from a radio station are very nearly the same frequency, they can interfere with each other, making it difficult to hear the broadcast.

**Static:** AM is easily affected by external sources of electrical noise, such as high tension power lines, lightening or electrical motors. This results in static.

### ■ SiriusXM

- Cargo loaded on the roof luggage carrier, especially metal objects, may adversely affect the reception of SiriusXM Satellite Radio.
- Alternation or modifications carried out without appropriate authorization may invalidate the user's right to operate the equipment.

## iPod/iPhone

### ■ Certification



- Use of the Made for Apple badge means that an accessory has been designed to connect specifically to the Apple product(s) identified in the badge, and has been certified by the developer to meet Apple performance standards. Apple is not responsible for the operation of this device or its compliance with safety and regulatory standards. Please note that the use of this accessory with an Apple product may affect wireless performance.
- CarPlay, iPhone, iPod, iPod nano, iPod touch, and Lightning are trademarks of Apple Inc., registered in the U.S. and other countries. Apple CarPlay is a trademark of Apple Inc.

### ■ Compatible models

The following iPod nano<sup>®</sup>, iPod touch<sup>®</sup> and iPhone<sup>®</sup> devices can be used with this system.

Made for

- iPhone X
- iPhone 8
- iPhone 8 Plus
- iPhone 7

- iPhone 7 Plus
- iPhone SE
- iPhone 6s
- iPhone 6s Plus
- iPhone 6
- iPhone 6 Plus
- iPhone 5s
- iPhone 5c
- iPhone 5
- iPhone 4s\*
- iPod touch (6th generation)
- iPod touch (5th generation)
- iPod nano (7th generation)

\*: May not be compatible with some systems

- This system only supports audio playback.
- Depending on difference between models or software versions etc., some models might be incompatible with this system.

### High-resolution sound source

This device supports high-resolution sound sources.

The definition of high-resolution is based on the standards of groups such as the CTA (Consumer Technology Association).

Supported formats and playable media are as follows.

#### ■ Supported formats

WAV, FLAC, ALAC, OGG Vorbis

#### ■ Playable media

USB

### File information

#### Compatible USB devices

USB communication formats	USB 2.0 HS (480 Mbps)
File formats	FAT 16/32
Correspondence class	Mass storage class

#### Compatible audio format

#### Compatible compressed files

Item	USB
Compatible file format	MP3/WMA/AAC
	WAV(LPCM)/FLAC/ALAC/OGG Vorbis
	MP4/AVI/WMV
Compatible file format (video)*	MP4/AVI/WMV
Folders in the device	Maximum 3000
Files in the device	Maximum 9999
Files per folder	Maximum 255

\*: USB video only

### Corresponding sampling frequency

File type	Frequency (kHz)
MP3 files: MPEG 1 LAYER 3	32/44.1/48
MP3 files: MPEG 2 LSF LAYER 3	16/22.05/24
WMA files: Ver. 7, 8, 9 <sup>*1</sup> (9.1/9.2)	32/44.1/48
AAC files: MPEG4/AAC-LC	11.025/12/16/ 22.05/24/32/ 44.1/48
WAV (LPCM) files <sup>*2</sup>	8/11.025/12/16/ 22.05/24/32/ 44.1/48/88.2/ 96/176.4/192
FLAC <sup>*2</sup>	8/11.025/12/16/ 22.05/24/32/ 44.1/48/88.2/ 96/176.4/192
ALAC <sup>*2</sup>	8/11.025/12/16/ 22.05/24/32/ 44.1/48/64/ 88.2/96
OGG Vorbis <sup>*2</sup>	8/11.025/16/ 22.05/32/44.1/ 48

<sup>\*1</sup>: Only compatible with Windows Media Audio Standard

<sup>\*2</sup>: Sound source of 48kHz or more is down-converted to 48kHz/24bit.

### Corresponding bit rates<sup>\*1</sup>

File type	Bit rate (kbps)
MP3 files: MPEG 1 LAYER 3	32 - 320
MP3 files: MPEG 2 LSF LAYER 3	8 - 160
WMA files: Ver. 7, 8	CBR 48 - 192
WMA files: Ver. 9 <sup>*2</sup> (9.1/9.2)	CBR 48 - 320
AAC files: MPEG4/AAC-LC	8 - 320
OGG Vorbis	32 - 500

<sup>\*1</sup>: Variable Bit Rate (VBR) compatible

<sup>\*2</sup>: Only compatible with Windows Media Audio Standard

File type	Quantization bit rate (bit)
WAV (LPCM) files	16/24
FLAC	
ALAC	

### Compatible channel modes

File type	Channel mode
MP3 files	Stereo, joint stereo, dual channel and monaural
WMA files	2ch

File type	Channel mode
AAC files	1ch, 2ch (Dual channel is not supported)
WAV (LPCM)/ FLAC/ALAC/ OGG Vorbis	2ch

- MP3 (MPEG Audio Layer 3), WMA (Windows Media Audio) and AAC (Advanced Audio Coding) are audio compression standards.
- This system can play MP3/WMA/AAC files on USB memory.
- MP4, WMV and AVI files can use the following resolutions: 128x96, 160x120, 176x144 (QCIF), 320x240 (QVGA), 352x240 (SIF), 352x288 (CIF), 640x480 (VGA), 720x480 (NTSC), 720x576 (PAL)
- When naming an MP3/WMA/AAC file, add an appropriate file extension (.mp3/.wma/.m4a).
- This system plays back files with .mp3/.wma/.m4a file extensions as MP3/WMA/AAC files respectively. To prevent noise and playback errors, use the appropriate file extension.
- MP3 files are compatible with the ID3 Tag Ver. 1.0, Ver. 1.1, Ver. 2.2 and Ver. 2.3 formats. This system cannot display disc title, track title and artist name in other formats.
- WMA/AAC files can contain a WMA/AAC tag that is used in the same way as an ID3 tag. WMA/AAC tags carry information such as track title and artist name.
- The emphasis function is available only when playing MP3 files.
- This system can play back AAC files encoded by iTunes.
- The sound quality of MP3/WMA files generally improves with higher bit rates.
- m3u playlists are not compatible with the audio player.
- MP3i (MP3 interactive) and MP3PRO formats are not compatible with the audio player.
- The player is compatible with VBR (Variable Bit Rate).
- When playing back files recorded as VBR (Variable Bit Rate) files, the play time will not be correctly displayed if the fast forward or reverse operations are used.
- It is not possible to check folders that do not include MP3/WMA/AAC files.
- MP3/WMA/AAC files in folders up to 8 levels deep can be played. However, the start of playback may be delayed

when using USB memory containing numerous levels of folders. For this reason, we recommend creating USB memory with no more than 2 levels of folders.

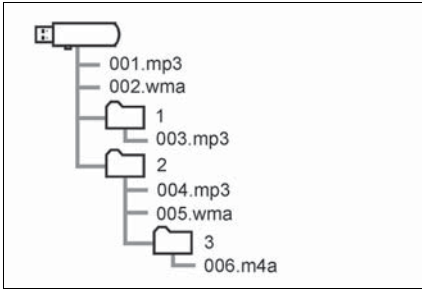

- The play order of the USB memory with the structure shown above is as follows:

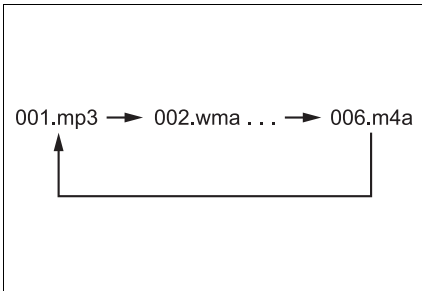

- The order changes depending on the personal computer and MP3/WMA/AAC encoding software you use.

**Compatible video format**

Format	Codec
MPEG-4	Video codec: <ul style="list-style-type: none"> <li>● H.264/MPEG-4 AVC</li> <li>● MPEG4</li> </ul> Audio codec: <ul style="list-style-type: none"> <li>● AAC</li> <li>● MP3</li> </ul> Corresponding screen size: <ul style="list-style-type: none"> <li>● MAX 1920×1080</li> </ul> Corresponding frame rate: <ul style="list-style-type: none"> <li>● MAX 60i/30p</li> </ul>

Format	Codec
AVI Container	<p>Video codec:</p> <ul style="list-style-type: none"> <li>• H.264/MPEG-4 AVC</li> <li>• MPEG4</li> <li>• WMV9</li> <li>• WMV9 Advanced profile</li> </ul> <p>Audio codec:</p> <ul style="list-style-type: none"> <li>• AAC</li> <li>• MP3</li> <li>• WMA9.2 (7, 8, 9.1, 9.2)</li> </ul> <p>Corresponding screen size:</p> <ul style="list-style-type: none"> <li>• MAX 1920×1080</li> </ul> <p>Corresponding frame rate:</p> <ul style="list-style-type: none"> <li>• MAX 60i/30p</li> </ul>
Windows Media Video	<p>Video codec:</p> <ul style="list-style-type: none"> <li>• WMV9</li> <li>• WMV9 Advanced profile</li> </ul> <p>Audio codec:</p> <ul style="list-style-type: none"> <li>• WMA9.2 (7, 8, 9.1, 9.2)</li> </ul> <p>Corresponding screen size:</p> <ul style="list-style-type: none"> <li>• MAX 1920×1080</li> </ul> <p>Corresponding frame rate:</p> <ul style="list-style-type: none"> <li>• MAX 60i/30p</li> </ul>

## Terms

### ■ ID3 tag

- This is a method of embed-

ding track related information in an MP3 file. This embedded information can include the track number, track title, the artist's name, the album title, the music genre, the year of production, comments, cover art and other data. The contents can be freely edited using software with ID3 tag editing functions. Although the tags are restricted to a number of characters, the information can be viewed when the track is played back.

### ■ WMA tag

- WMA files can contain a WMA tag that is used in the same way as an ID3 tag. WMA tags carry information such as track title and artist name.

### ■ MP3

- MP3 is an audio compression standard determined by a working group (MPEG) of the ISO (International Standard Organization). MP3 compresses audio data to about 1/10 the size of that on conventional discs.

### ■ WMA

- WMA (Windows Media Audio) is an audio compression format developed by Microsoft®. It compresses files into a size smaller than that of MP3 files. The decoding formats for

WMA files are Ver. 7, 8 and 9.

- Windows Media is either a registered trademark or trademark of Microsoft Corporation in the United States and/or other countries. This product is protected by certain intellectual property rights of Microsoft. Use or distribution of such technology outside of this product is prohibited without a license from Microsoft.
- This product includes technology owned by Microsoft Corporation and cannot be used or distributed without a license from Microsoft Licensing, Inc.

#### ■ AAC

- AAC is short for Advanced Audio Coding and refers to an audio compression technology standard used with MPEG2 and MPEG4.

## Error messages

### ■ USB

Message	Explanation
"USB Error"	This indicates a problem in the USB memory or its connection.
"No music files found."	This indicates that no MP3/WMA/AAC files are included in the USB memory.
"No video files found."	This indicates that no video files are included in the USB memory.

### ■ iPod

Message	Explanation
"iPod Error"	This indicates a problem in the iPod or its connection.
"No music files found."	This indicates that there is no music data in the iPod.



Message	Explanation
“Please check the iPod firmware version.”	This indicates that the firmware version is not compatible. Perform the iPod firmware updates and try again.
“Unable to authorize the iPod.”	This indicates that it failed to authorize the iPod. Please check your iPod.

#### ■ Bluetooth® audio

Message	Explanation
“Music tracks not supported. Please check your portable player.”	This indicates a problem in the Bluetooth® device.

- If the malfunction is not rectified:  
Take your vehicle to your Toyota dealer.



# Voice command system

## 5

### 5-1. Voice command system operation

Voice command system .....	158
Natural language understanding.....	161
Command list .....	162

### 5-2. Mobile Assistant operation

Mobile Assistant .....	167
------------------------	-----

## Voice command system

The voice command system enables the radio, phone dialing, etc. to be operated using voice commands. Refer to the command list for samples of voice commands. (→P.162)

## Using the voice command system

### Steering switch

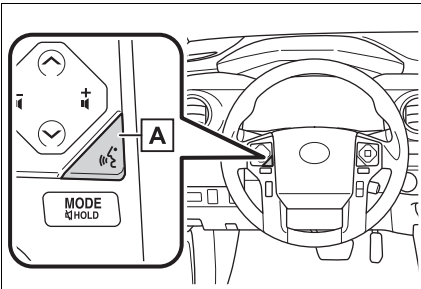

#### A Talk switch

Voice command system:

- Press the talk switch to start the voice command system. To cancel voice command, press and hold the talk switch.

When an Apple CarPlay/Android Auto connection is established:

- Press and hold the talk switch to start Siri/Google Assistant. To cancel Siri/Google Assistant, press the talk switch.
- Press the talk switch to start the voice command system.

### Microphone

#### ▶ Type A

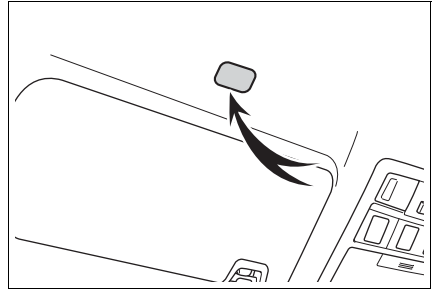

#### ▶ Type B

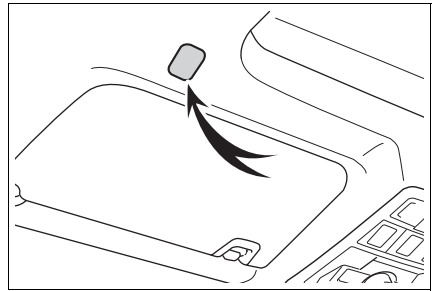

- It is unnecessary to speak directly into the microphone when giving a command.

- Voice commands may not be recognized if:
  - Spoken too quickly.
  - Spoken at a low or high volume.
  - The roof or windows are open.
  - Passengers are talking while voice commands are spoken.
  - The fan speed of the air conditioning system is set at high.
  - The air conditioning vents are turned towards the microphone.
- In the following conditions, the system may not recognize the command properly and using voice commands may not be possible:
  - The command is incorrect or unclear. Note that certain words, accents or speech patterns may be difficult for the system to recog-

- nize.
- There is excessive background noise, such as wind noise.
- Normally, it is necessary to wait for a beep before saying a command. To enable the ability to talk over prompts and say commands before the beep, enable the voice prompt interrupt function. (→P.64)
- This system may not operate immediately after the engine switch is in ACC or ON.



#### NOTICE

- Do not touch and put a sharp object to the microphone. It may cause failure.

### Voice command system operation

The voice command system is operated by saying commands which correspond to a supported function. To display examples of commands for supported functions, select a function button on the screen after starting the voice command system.

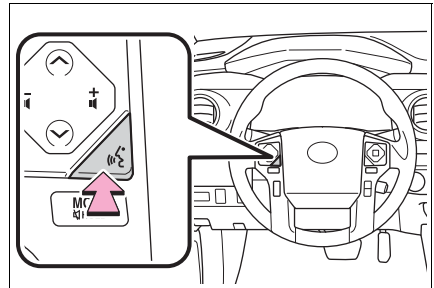

#### Operation from the main menu

- 1 Press the talk switch.



- Voice guidance for the voice command system can be skipped by pressing the talk switch.
- 2 If “Getting Started with Voice” screen is displayed, select “OK” or press the talk switch. (→P.160)
  - 3 After hearing a beep, say a supported command.
- To display sample commands of the desired function, say the desired function or select the desired function button. To display more commands, select “More Commands”.
  - Selecting “Help” or saying “Help” prompts the voice command system to offer examples of commands and operation methods.
  - Registered POIs, registered names in the contacts list etc., can be said in the place of the “<>” next to the commands. (→P.162)

For example: Say “Find a restaurant”, “Call John Smith” etc.

- If a desired outcome is not shown, or if no selections are available, perform one of the following to return to the previous screen:
  - Say “Go back”.
  - Select .
  - To cancel voice recognition, select , say “Cancel”, or press and hold the talk switch.
  - To perform the voice command operation again, select “Start Over” or say “Start over”.
  - To suspend voice command operation, select “Pause” or say “Pause”. To resume the voice command operation, select “Resume” or press the talk switch.

- 
- If the system does not respond or the confirmation screen does not disappear, press the talk switch and try again.
  - If a voice command cannot be recognized 3 consecutive times, voice recognition will be canceled.
  - Voice recognition prompts can be changed on the voice settings screen. (→P.64)

This function can be used to cancel voice guidance by turning the voice prompts off. When you press the talk switch while using this setting, a beep sounds, and then you can immediately say a command.

- Some voice guidance can be can-

celed by setting voice prompts to off. Use this setting when it is desirable to say a command immediately after pressing the talk switch and hearing a beep.

**Increasing the voice recognition performance**

To increase voice recognition performance, use the “Tutorials” and “Voice Training” functions on the “Getting Started with Voice” screen. These functions are only available when the vehicle is not moving.

The “Tutorials” and “Voice Training” functions can also be started on the voice settings screen. (→P.64)

- 1 Press the talk switch.
- 2 Select the desired item to be set.

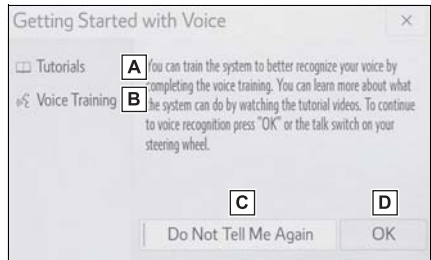

- A** Select to display the voice command tutorials.
- B** Select to train the voice command system.

The user will be asked to say 10 sample phrases. This will help the voice command system adapt to the user’s accent.

- C** Select to prevent the screen

from being displayed again.

- D** Select to proceed to the voice command screen.

### Dictation function (English only)\*

\*: Premium Audio only. This function is not made available in some countries or areas.

Text messages can be written using the dictation function.

To use the dictation function, a subscription to the connected services is necessary. Contact your Toyota dealer for details.

- 1** Select .

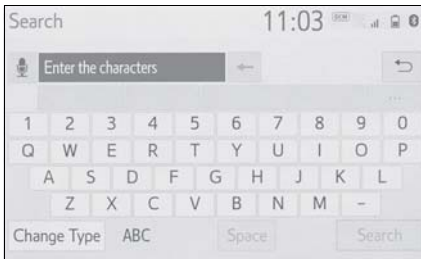

- 2** Speak to the system.

- Words recognized through your speech will be displayed. To confirm the entered text, select "OK".

---

- A keyboard screen will not be displayed when the vehicle is being driven.
- Text message reply with the dictation function may not be available depending on the type of cellular phone.

### Natural language understanding\*

\*: Premium Audio only. This function is not made available in some countries or areas.

**Due to natural language speech recognition technology, this system recognizes commands when spoken naturally. (If a connected services subscription has been entered, the system will be able to connect to the Cloud and the range of naturally spoken English which can be recognized will be increased.) However, the system cannot recognize every variation of each command. In some situations, it is possible to omit the command for the procedure and directly state the desired operation. Not all voice commands are displayed in the function menu.**

**To use this function, a subscription to the connected services is necessary. Contact your Toyota dealer for details.**

## Command list

### Command list overview

Recognizable voice commands and their actions are shown below.

- Frequently used commands are listed in the following tables.
- For devices that are not installed to the vehicle, commands relating to that device may not be displayed on the screen. Also, depending on other conditions, such as compatibility, some commands may not be displayed on the screen.
- The functions available may vary according to the system installed.
- Voice recognition language can be changed. (→P.60)
- When an Apple CarPlay/Android Auto connection is established, some commands will become unavailable.

## Command list

### ■ Common

Command	Action
"Help"	Displays examples of some of the available commands
"Go back"	Returns to the previous screen
"Cancel"	Cancels the voice command system
"Start over"	Returns to top menu screen
"Pause"	Temporarily pauses a voice session until it is resumed by pressing the talk switch again.

### ■ Top menu

Command	Action
"Show command examples for <menu>"	Displays the command list of the selected menu
"More commands"	Displays more commonly used commands
"Voice settings"	Displays Voice Setting screen
"Train my voice"	Displays Train Voice Recognition screen*

\*: Vehicle must be parked



## ■ Navigation <sup>\*1</sup>

Command	Action
“Get directions to <house #, street, city, state>” <sup>*2</sup>	Enables setting a destination by saying the address <sup>*3, 4</sup>
“Find a <POI category> <sup>*5</sup> /POI name” <sup>*6</sup>	Displays a list of <POI category> <sup>*5</sup> /POI name <sup>*6</sup> near the current position
“Find a <POI> near my destination”	Displays a list of <POI> near the destination
“Find a <POI category> in a city” <sup>*2</sup>	Displays a list of <POI> in a specified city and state <sup>*7</sup>
“Go home”	Displays the route to home
“Go to favorite <1-10>”	Sets the location registered to the corresponding favorite number as the destination
“Show recent destinations”	Displays recent destinations. Selecting a number from the list will start navigation to the selected recent destination.
“Cancel route”	Cancels the route guidance

Command	Action
“Delete destinations”	Displays a list of destination to delete <sup>*8</sup>
“Show <POI category> icons”	Displays the specified point of interest category <sup>*5</sup> icons on the map

<sup>\*1</sup>: Premium Audio only

<sup>\*2</sup>: English and French only

<sup>\*3</sup>: Best recognition results occur when saying the full address without the zipcode

<sup>\*4</sup>: When the language is set to French, the supported area is only Quebec Province in Canada

<sup>\*5</sup>: For example; “Gas stations”, “Restaurants”, etc.

<sup>\*6</sup>: Major national brands are always supported. Local brands are also supported with a subscription to the connected services. Contact your Toyota dealer for details.

<sup>\*7</sup>: When the language is set to French, the supported area is only Quebec City in Canada

<sup>\*8</sup>: Used when multiple destinations are set on a route

### ■ Phone <sup>\*1</sup>

Command	Action
“Call <contact>” <sup>*2</sup>	Places a call to the specified contact from the phone book
“Call <contact> <phone type>” <sup>*2</sup>	Places a call to the specified phone type of the contact from the phone book
“Dial <phone number>”	Places a call to the specified phone number
“Redial”	Places a call to the phone number of the latest outgoing call
“Call back”	Places a call to the phone number of latest incoming call
“Show recent calls”	Displays the call history screen
“Send a message to <contact>”	Sends a text message to specified contact from the phone book

<sup>\*1</sup>: When an Apple CarPlay connection is established, this voice commands will be unavailable.

<sup>\*2</sup>: If the system does not recognize the name of a contact, create a voice tag. (→P.267) The name of a contact can also be recognized by adding a voice tag.

### ■ While in a phone call <sup>\*</sup>

Command	Action
“Send <digits>”	Sends DTMF tones has specified
“Mute”	Mutes the microphone (far side cannot hear the conversation)
“Unmute”	Unmutes the microphone

<sup>\*</sup>: When an Apple CarPlay connection is established, this voice commands will be unavailable.

### ■ While incoming message notification is displayed<sup>\*1, 2</sup>

Command	Action
“Read message”	Reads the incoming message over the vehicle speakers
“Ignore”	Ignores the incoming message notification
“Reply”	Initiates sending a reply to the incoming message
“Call”	Places a call to the phone number of incoming message

<sup>\*1</sup>: Full screen message notification must be turned on within the phone settings (→P.265)

<sup>\*2</sup>: When an Apple CarPlay connection is established, this voice

commands will be unavailable.

## ■ Radio

Command	Action
"Tune to <frequency> AM"	Changes the radio to the specified AM frequency
"Tune to <frequency> FM"	Changes the radio to the specified FM frequency
"Play a <genre> station"	Changes the radio to an FM station of the specified genre <sup>*1</sup>
"Tune to preset <1-36>"	Changes the radio to the specified preset radio station
"Tune to a <genre> satellite station" <sup>*2</sup>	Changes the radio to a satellite radio channel of the specified genre <sup>*3</sup>
"Tune to <satellite channel name>" <sup>*2</sup>	Changes the radio to the satellite radio channel with the specified name <sup>*3</sup>
"Tune to channel <number> on XM" <sup>*2</sup>	Changes the radio to a satellite radio channel of the specified number <sup>*3</sup>

<sup>\*1</sup>: A station list must be built first using the radio screen (→P.125)

<sup>\*2</sup>: If equipped

<sup>\*3</sup>: Requires a satellite radio sub-

scription

## ■ Audio <sup>\*1</sup>

Command	Action
"Play Playlist <name>" <sup>*2</sup>	Plays tracks from the selected playlist
"Play Artist <name>" <sup>*2</sup>	Plays tracks from the selected artist
"Play Song <name>" <sup>*2</sup>	Plays the selected track
"Play Album <name>" <sup>*2</sup>	Plays tracks from the selected album
"Play Genre <name>" <sup>*2</sup>	Plays tracks from the selected genre
"Play Composer <name>" <sup>*2</sup>	Plays tracks from the selected composer
"Play Podcast <name>" <sup>*2</sup>	Plays tracks from the selected podcast
"Play Audiobook <name>" <sup>*2</sup>	Plays tracks from the selected audiobook
"Audio On"	Turns the audio/visual system on
"Audio Off"	Turns the audio/visual system off
"Change the audio source to <source name>"	Sets the source to the specified audio mode

\*1: The audio device must be connected via a USB cable to use the functionality in this section

\*2: When an Apple CarPlay connection is established, this voice commands will be unavailable.

**■ Information\*1**

Command	Action
“Get the Forecast”	Displays weather information
“Get the Forecast for <city>” <sup>*2</sup>	Displays weather for the specified city
“Show Traffic”	Displays traffic information
“Show Traffic near here”	Displays traffic information near your current location
“Get traffic along my route”	Displays traffic information along your current route
“Show Traffic on this street”	Displays traffic information along road you are currently driving on
“Show Traffic for saved route”	Displays traffic information for a saved route
“Show Predictive Traffic”	Displays the predictive traffic map

\*1: Premium Audio only

\*2: Only major US cities are supported by voice

**■ Toyota apps\*1**

Command	Action
“Launch <application name>” <sup>*2</sup>	Activates the Toyota apps

\*1: When an Apple CarPlay connection is established, this voice commands will be unavailable.

\*2: When an application is opened and is in full screen mode, pressing the talk switch will start the voice command system and commands for the currently displayed application will be available

---

● Commands relating to operation of the audio/visual system can only be performed when the audio/visual system is turned on.

## Mobile Assistant\*

\*: For countries or areas where Apple CarPlay/Android Auto is not available

**The Mobile Assistant function is a voice input assist function. Mobile Assist supports the Siri Eyes Free Mode and Google App. (Google App can be used only with the corresponding device.) Instructions can be spoken into the vehicle microphone as if speaking a command to the phone. The content of the request is then interpreted by the phone and the result is output from the vehicle speakers. To operate the Mobile Assistant, a compatible device must be registered and connected to this system via Bluetooth®. (→P.36)**

## Connectable devices and available functions

Mobile Assist supports the Siri Eyes Free Mode and Google App. The available features and functions may vary based on the iOS/Android version installed on the connected device.

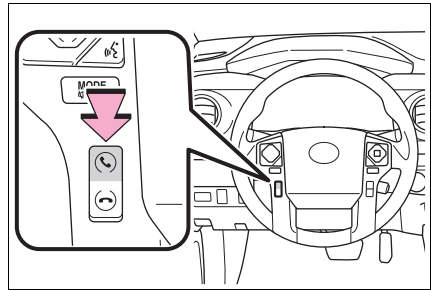

## Mobile Assistant operation

- 1 Press and hold the  switch on the steering wheel until Mobile Assistant screen is displayed.

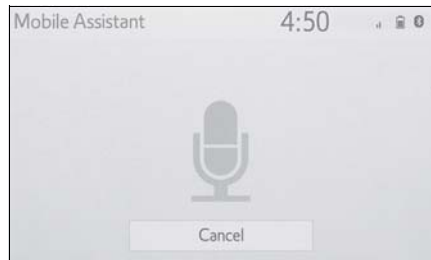

- 2 The Mobile Assistant can be used only when the following screen is displayed.



- To cancel the Mobile Assistant, select "Cancel" or press and hold the  switch on the steering wheel.
- To restart the Mobile Assistant for additional commands, press the  switch on the steering wheel.
- Mobile Assistant can only be restarted after the system responds to a voice command.

- After some phone and music commands, the Mobile Assistant feature will automatically end to complete the requested action.
  - The volume of the Mobile Assistant can be adjusted using the “POWER VOLUME” knob or steering wheel volume control switches. The Mobile Assistant and phone call volumes are synchronized.
- 
- While a phone call is active, the Mobile Assistant cannot be used.
  - If using the navigation feature of the cellular phone, ensure the active audio source is Bluetooth<sup>®</sup> audio or iPod in order to hear turn by turn direction prompts.
  - Wait for the listening beeps before using the Mobile Assistant.
  - The Mobile Assistant may not recognize commands in the following situations:
    - Spoken too quickly.
    - Spoken at a low or high volume.
    - The roof or windows are open.
    - Passengers are talking while the Mobile Assistant is being used.
    - The fan speed of the air conditioning system is set at high.
    - The air conditioning vents are turned toward the microphone.

**6-1. Information display**

Receiving weather information ..... **170**

Data services settings. **172**

## Receiving weather information\*

\*: Premium Audio only

**Weather information can be received via HD Radio broadcast or DCM (Data Communication Module).**

## Displaying weather screen

1 Press the “MENU” button.

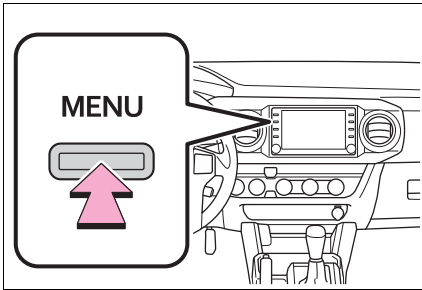

2 Select “Info”.

3 Select “Weather”.

4 Check that the weather screen is displayed.



**A** Select to display the current weather information.  
(→P.171)

**B** Select to display a 3-day

weather forecast for the currently displayed location. To view the details of a specific day, select the date.

**C** Select to display the weather information for the next 6 hours and 12 hours. (This button is not displayed when a location is selected from the “National Cities” list of “National/Local”.)

**D** Select to display the weather of a desired location in the recently checked locations list.

**E** Select to change the displayed weather location. A location can be selected from two different lists: a list of national cities and a list of local cities. (→P.171)

**F** Select to display Doppler weather radar information over the map.

● This function is not made available in some countries or areas.

● The weather for current location might not show the closest city when it first displays.

● The weather information is updated every 5 to 90 minutes. The time elapsed since the last update is displayed at the bottom right corner of the screen. If the weather has been updated less than 5 minutes ago, “Now” will be displayed.



### Displaying weather information for the current location

- 1 Display the weather screen. (→P.170)
  - 2 Select “Current”.
  - 3 Check the weather information for the current location.
- By selecting “3 Day” or “6/12 Hour”, different types of weather information for the current location will be displayed.

### Selecting a location

- 1 Display the weather screen. (→P.170)
- 2 Select “National/Local”.
- 3 Select the desired item to be set.



- A** Select to display the list of National cities. When the list is displayed, select the desired area.
  - B** Select to display the list of local cities.
- 4 Select the desired location from the list.

- After selecting a location, the current weather information will be displayed. By selecting “3 Day” or “6/12 Hour”, the different type of weather information for the selected location is displayed.

### Weather guidance service

When weather information for areas around the current position, destination, or along the set route is available, important information will be output through the speakers and a pop-up message asking if you would like to view the full weather information will be displayed.

- 1 Select “Yes” when the pop-up message appears.
  - 2 Check that the weather information is displayed.
- The time since the information was last updated is displayed.
  - When detailed audio weather information is available, an icon will be displayed on the weather map. Select the icon to listen to the weather information.

## Data services settings\*

\* : Premium Audio only

**Data service information, which is comprised of traffic information and weather information, can be received via HD Radio broadcast or DCM (Data Communication Module). The receiving method can be set to both or only via HD Radio broadcast.**

## Setting download methods

1 Press the "MENU" button.

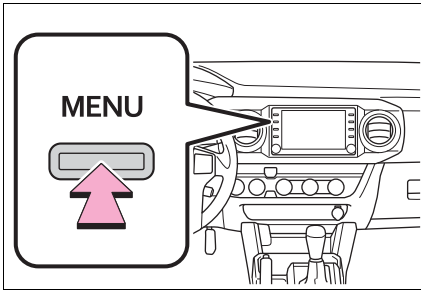

- 2 Select "Setup".
- 3 Select "Data Services".
- 4 Select "Data Download Source".

5 Select the desired item to be set.

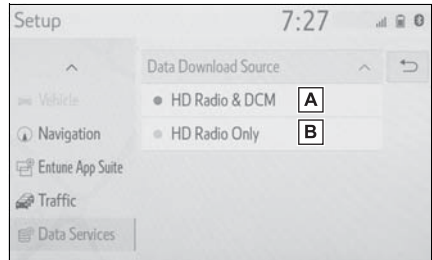

- A Select to receive data service information via both HD Radio broadcast and the DCM. When both methods are available, HD Radio broadcast will be selected.
- B Select to receive data only via HD Radio broadcast.

● This function is not made available in some countries or areas.

# Peripheral monitoring system

## 7

### 7-1. Rear view monitor system

Rear view monitor system  
..... **174**

Rear view monitor system  
precautions..... **176**

Things you should know  
..... **181**

### 7-2. Panoramic view monitor

Panoramic view monitor  
..... **183**

Checking the front and  
around the vehicle..... **186**

Checking the sides of the  
vehicle..... **188**

Checking the rear and  
around the vehicle..... **191**

Panoramic view monitor  
precautions..... **196**

Things you should know  
..... **207**

### 7-3. Multi-terrain Monitor

Multi-terrain Monitor .... **209**

Changing the Multi-terrain  
Monitor screen ..... **213**

Screen display and func-  
tions (for off-road)..... **216**

Screen display and func-  
tions (for on-road)..... **225**

Multi-terrain Monitor precau-  
tions..... **233**

Things you should know  
..... **244**

## Rear view monitor system<sup>\*</sup>

\*: If equipped

**The rear view monitor system assists the driver by displaying an image of the view behind the vehicle with fixed guide lines on the screen while backing up, for example while parking.**

● The screen illustrations used in this text are intended as examples, and may differ from the image that is actually displayed on the screen.

### Driving precautions

The rear view monitor system is a supplemental device intended to assist the driver when backing up. When backing up, be sure to visually check all around the vehicle both directly and using the mirrors before proceeding. If you do not, you may hit another vehicle, and could possibly cause an accident.

Pay attention to the following precautions when using the rear view monitor system.

### WARNING

- Never depend on the rear view monitor system entirely when backing up. The image and the position of the guide lines displayed on the screen may differ from the actual state. Use caution, just as you would when backing up any vehicle.
- Be sure to back up slowly, depressing the brake pedal to control vehicle speed.
- The instructions given are only guide lines. When and how much to turn the steering wheel will vary according to traffic conditions, road surface conditions, vehicle condition, etc. when parking. It is necessary to be fully aware of this before using the rear view monitor system.
- When parking, be sure to check that the parking space will accommodate your vehicle before maneuvering into it.
- Do not use the rear view monitor system in the following cases:
  - On icy or slick road surfaces, or in snow
  - When using tire chains or emergency tires
  - When the tailgate is not closed completely
  - On roads that are not flat or straight, such as curves or slopes

**WARNING**

- In low temperatures, the screen may darken or the image may become faint. The image could distort when the vehicle is moving, or you may become unable to see the image on the screen. Be sure to visually check all around the vehicle both directly and using the mirrors before proceeding.
- If the tire sizes are changed, the position of the fixed guide lines displayed on the screen may change.
- The camera uses a special lens. The distances between objects and pedestrians that appear in the image displayed on the screen will differ from the actual distances. (→P.177)

**Screen description**

The rear view monitor system screen will be displayed if the shift lever is shifted to the “R” position while the engine switch is in ON.

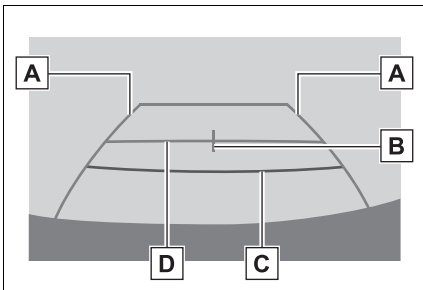
**A** Vehicle width guide line

Displays a guide path when the vehicle is being backed straight up.

- The displayed width is wider than the actual vehicle width.

**B** Vehicle center guide line

This line indicates the estimated vehicle center on the ground.

**C** Distance guide line

Shows distance behind the vehicle.

- Displays a point approximately 1.5 ft. (0.5 m) (red) from the edge of the bumper.

**D** Distance guide line

Shows distance behind the vehicle.

- Displays a point approximately 3 ft. (1 m) (blue) from the edge of the bumper.

**Canceling rear view monitor system**

The rear view monitor system is canceled when the shift lever is shifted into any position other than the “R” position.

## Rear view monitor system precautions

### Area displayed on screen

The rear view monitor system displays an image of the view from the bumper of the rear area of the vehicle.

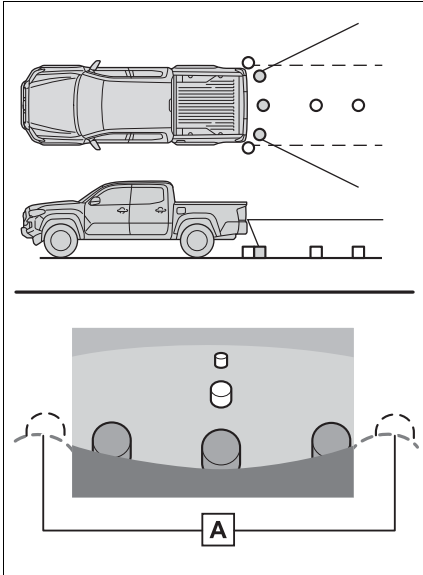

#### A Corners of bumper

- The area around both corners of the bumper will not be displayed.
- The image adjustment procedure for the rear view monitor system screen is the same as the procedure for adjusting the screen. (→P.33)
- The area displayed on the screen may vary according to vehicle orientation conditions.
- Objects which are close to either corner of the bumper or under the bumper cannot be displayed.

- The camera uses a special lens. The distance of the image that appears on the screen differs from the actual distance.
- Items which are located higher than the camera may not be displayed on the monitor.

### The camera

The camera for the rear view monitor system is located as shown in the illustration.

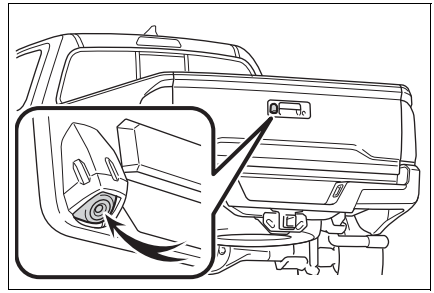

#### ■ Using the camera

If dirt or foreign matter (such as water droplets, snow, mud, etc.) is adhering to the camera, it cannot transmit a clear image. In this case, flush it with a large quantity of water and wipe the camera lens clean with a soft and wet cloth.

**NOTICE**

- The rear view monitor system may not operate properly in the following cases.
  - If the back of the vehicle is hit, the position and mounting angle of the camera may change.
  - As the camera has a water proof construction, do not detach, disassemble or modify it. This may cause incorrect operation.
  - When cleaning the camera lens, flush the camera with a large quantity of water and wipe it with a soft and wet cloth. Strongly rubbing the camera lens may cause the camera lens to be scratched and unable to transmit a clear image.
  - Do not allow organic solvent, car wax, window cleaner or a glass coating to adhere to the camera. If this happens, wipe it off as soon as possible.
  - If the temperature changes rapidly, such as when hot water is poured on the vehicle in cold weather, the system may not operate normally.
  - When washing the vehicle, do not apply intensive bursts of water to the camera or camera area. Doing so may result in the camera malfunctioning.
- Do not expose the camera to strong impact as this could cause a malfunction. If this happens, have the vehicle inspected by your Toyota dealer as soon as possible.

### Differences between the screen and the actual road

- The distance guide lines and

the vehicle width guide lines may not actually be parallel with the dividing lines of the parking space, even when they appear to be so. Be sure to check visually.

- The distances between the vehicle width guide lines and the left and right dividing lines of the parking space may not be equal, even when they appear to be so. Be sure to check visually.
- The distance guide lines give a distance guide for flat road surfaces. In any of the following situations, there is a margin of error between the guide lines on the screen and the actual distance/course on the road.
  - **When the ground behind the vehicle slopes up sharply**

The distance guide lines will appear to be closer to the vehicle than the actual distance. Because of this, objects will appear to be farther away than they actually are. In the same way, there will be a margin of error between the guide lines and the actual distance/course on the road.

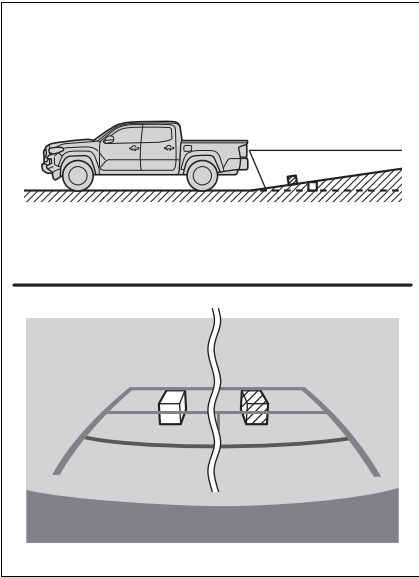

■ **When the ground behind the vehicle slopes down sharply**

The distance guide lines will appear to be farther from the vehicle than the actual distance. Because of this, objects will appear to be closer than they actually are. In the same way, there will be a margin of error between the guide lines and the actual distance/course on the road.

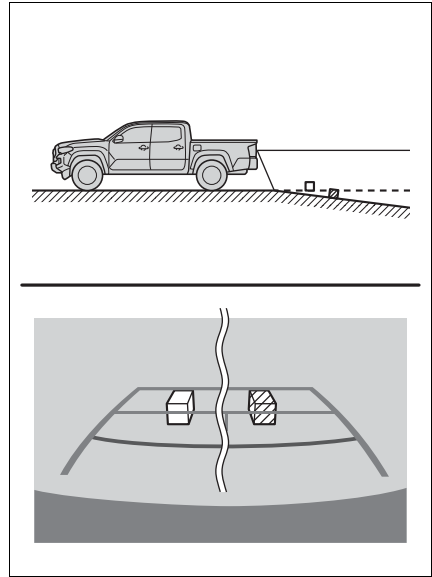

■ **When any part of the vehicle sags**

When any part of the vehicle sags due to the number of passengers or the distribution of the load, there is a margin of error between the fixed guide lines on the screen and the actual distance/course on the road.

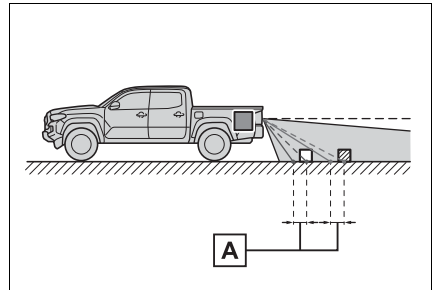

**A** A margin of error



## When approaching three-dimensional objects

The distance guide lines are displayed according to flat surfaced objects (such as the road). It is not possible to determine the position of three-dimensional objects (such as vehicles) using the vehicle width guide lines and distance guide lines. When approaching a three-dimensional object that extends outward (such as the flatbed of a truck), be careful of the following.

### ■ Vehicle width guide lines

Visually check the surroundings and the area behind the vehicle. In the case shown below, the truck appears to be outside of the vehicle width guide lines and the vehicle does not look as if it hits the truck. However, the rear body of the truck may actually cross over the vehicle width guide lines. In reality if you back up as guided by the vehicle width guide lines, the vehicle may hit the truck.

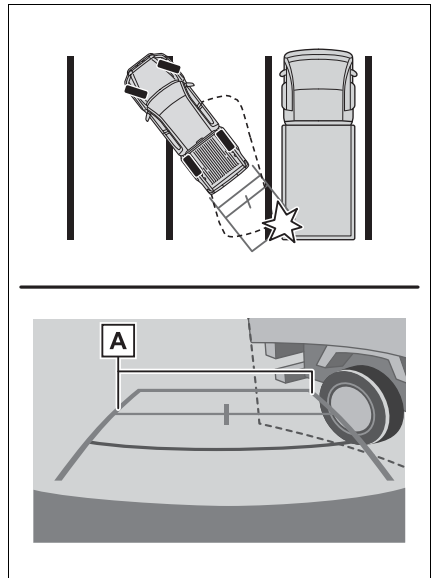

**A** Vehicle width guide lines

### ■ Distance guide lines

Visually check the surroundings and the area behind the vehicle. On the screen, it appears that a truck is parking at point **B**. However, in reality if you back up to point **A**, you will hit the truck. On the screen, it appears that **A** is closest and **C** is farthest away. However, in reality, the distance to **A** and **C** is the same, and **B** is farther than **A** and **C**.

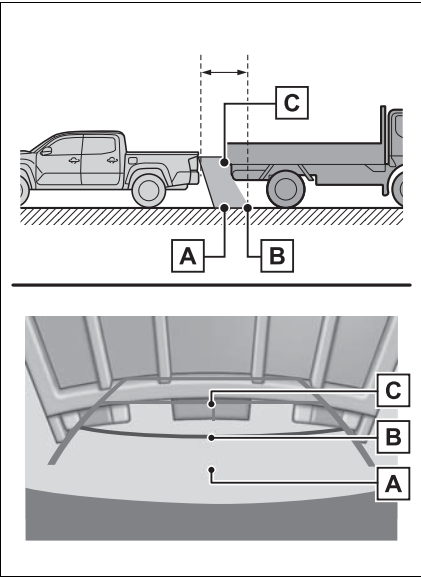

## Things you should know

### If you notice any symptoms

If you notice any of the following symptoms, refer to the likely cause and the solution, and re-check.

If the symptom is not resolved by the solution, have the vehicle inspected by your Toyota dealer.

Symptom	Likely cause	Solution
The image is difficult to see	<ul style="list-style-type: none"> <li>• The vehicle is in a dark area</li> <li>• The temperature around the lens is either high or low</li> <li>• The outside temperature is low</li> <li>• There are water droplets on the camera</li> <li>• It is raining or humid</li> <li>• Foreign matter (mud etc.) is adhering to the camera</li> <li>• Sunlight or headlights are shining directly into the camera</li> <li>• The vehicle is under fluorescent lights, sodium lights, mercury lights etc.</li> </ul>	<p>Back up while visually checking the vehicle's surroundings. (Use the monitor again once conditions have been improved.)</p> <p>The procedure for adjusting the picture quality of the rear view monitor system is the same as the procedure for adjusting the screen. (→P.33)</p>
The image is blurry	Dirt or foreign matter (such as water droplets, snow, mud etc.) is adhering to the camera.	Flush the camera with a large quantity of water and wipe the camera lens clean with a soft and wet cloth.
The image is out of alignment	The camera or surrounding area has received a strong impact.	Have the vehicle inspected by your Toyota dealer.

Symptom	Likely cause	Solution
The fixed guide lines are very far out of alignment	The camera position is out of alignment.	Have the vehicle inspected by your Toyota dealer.
	<ul style="list-style-type: none"><li>• The vehicle is tilted (there is a heavy load on the vehicle, tire pressure is low due to a tire puncture, etc.)</li><li>• The vehicle is used on an incline.</li></ul>	<p>If this happens due to these causes, it does not indicate a malfunction.</p> <p>Back up while visually checking the vehicle's surroundings.</p>

## Panoramic view monitor\*

\*: If equipped

**Panoramic view monitor assists the driver in viewing the surroundings, when operating at low speeds, by combining the front, side and rear cameras and displaying a complete vehicle overhead image on the screen.**

- The screen illustrations used in this text are intended as examples, and may differ from the image that is actually displayed on the screen.

### **! WARNING**

- Always make sure to check all around the vehicle with your own eyes when driving.
- The camera uses a special lens. The distances between objects and pedestrians that appear in the image displayed on the screen will differ from the actual distances.

### Camera switch

The camera switch is located as shown in the illustration.

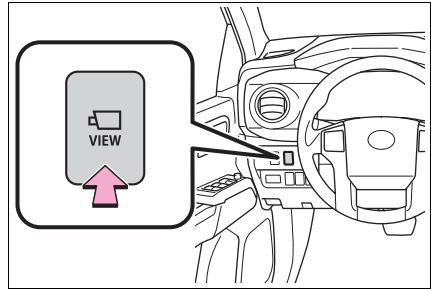

## Screens

### Checking the front and around the vehicle

- ▶ Panoramic view & wide front view (→P.186)

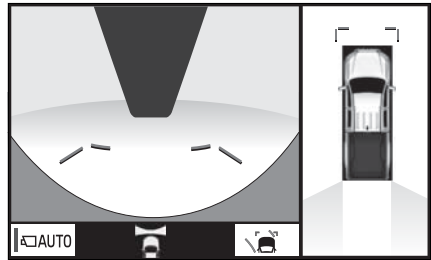

### Checking the sides of the vehicle

- ▶ Side views (→P.188)

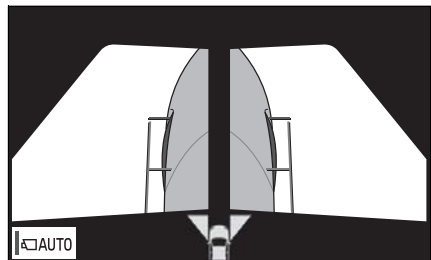

**Checking the rear and around the vehicle**

- ▶ Panoramic view & rear view (→P.191)

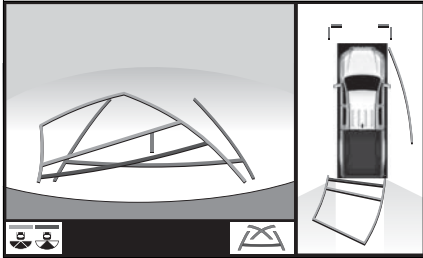

- ▶ Wide rear view (→P.191)

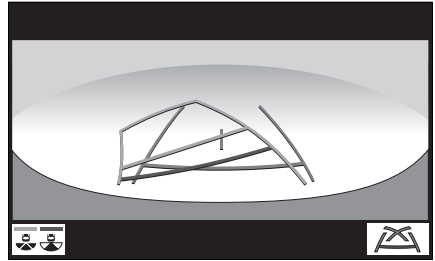

**How to switch the display**

When you press the camera switch or shift the shift lever to the “R” position while the engine switch is in ON, the panoramic view monitor operates. (The following is an example)

- ▶ When the shift lever is in a position other than “R”

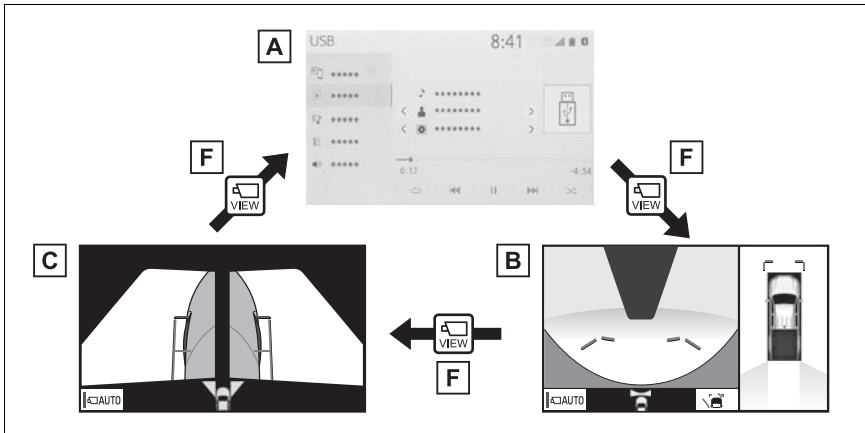

- ▶ When the shift lever is in the “R” position

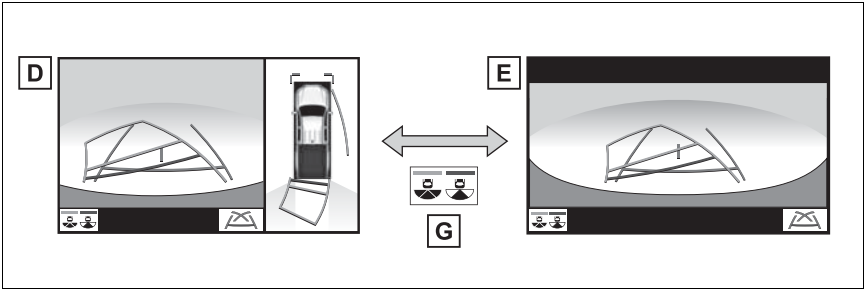

- A** Map screen, audio screen, etc.
- B** Panoramic view & wide front view
- C** Side views
- D** Panoramic view & rear view
- E** Wide rear view
- F** Pressing the camera switch
- G** Selecting the display mode switching button\*

\*: The screen display can be switched by touching the image from the camera on the screen.

- The panoramic view monitor is displayed by operating the camera switch when vehicle speed is approximately 7 mph (12 km/h) or less.

## Checking the front and around the vehicle

The panoramic view & wide front view screen provides support when checking the areas in front of the vehicle and around the vehicle when taking-off at T-intersections or other intersections during poor visibility.

To display the screen, press the camera switch when the shift lever is in a position other than “R” with the vehicle moving approximately 7 mph (12 km/h) or less.

## Screen display

### ▶ Panoramic view & wide front view

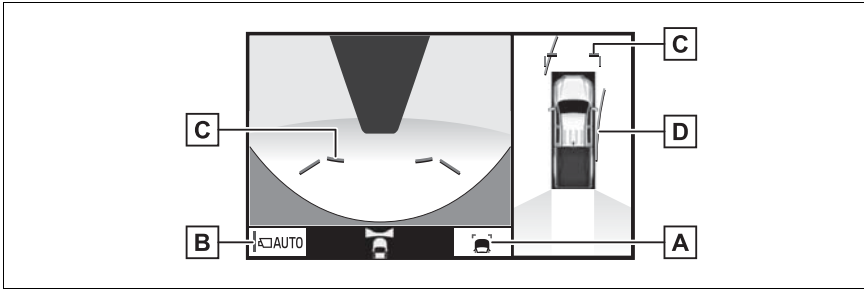

#### **A** Guide line switching button

Select to change the guide line mode between the distance guide line display mode and the estimated course line display mode. (→P.187)

#### **B** Automatic display button

Select to turn automatic display mode on/off. The indicator on the button illuminates during automatic display mode. (→P.187)

#### **C** Front distance guide line (blue)

Shows distance in front of the vehicle.

- Display points approximately 3 ft. (1 m) from the edge of the bumper.

#### **D** Forward projected course lines

Shows an estimated course when the steering wheel is turned.

- This line will be displayed when the steering wheel is turned more than 90° from the center.



### Switching the guide line mode

Each time the guide line switching button is selected, the mode will change as follows:

#### ▶ Distance guide line

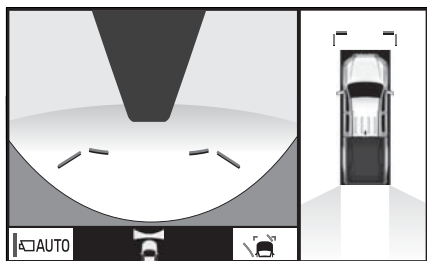

- Only the distance guide lines are displayed.

#### ▶ Projected course line

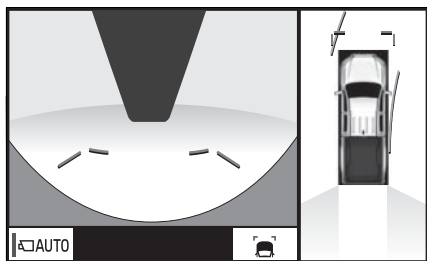

- Projected course lines will be added to the distance guide lines.

### Automatic display mode

In addition to screen switching by operating the camera switch, automatic display mode is available. In this mode, the screen is switched automatically in response to vehicle speed.

Each time  is selected,

automatic display mode is enabled/disabled.

In automatic mode, the monitor will automatically display images in the following situations:

- Vehicles with an automatic transmission: When the shift lever is shifted to “N” or “D” position.
- Vehicles with a manual transmission: When the shift lever is in a position other than “R” and the vehicle starts moving.
- When vehicle speed is reduced to approximately 6 mph (10 km/h) or less.

## Checking the sides of the vehicle

The image from the both side cameras is displayed and assists the driver to check conditions on the sides of the vehicle or to confirm the safety of narrow roads.

To display the Side views screen, press the camera switch repeatedly when the shift lever is in a position other than “R” with the vehicle moving approximately 7 mph (12 km/h) or less.

## Screen display

### ► Side views

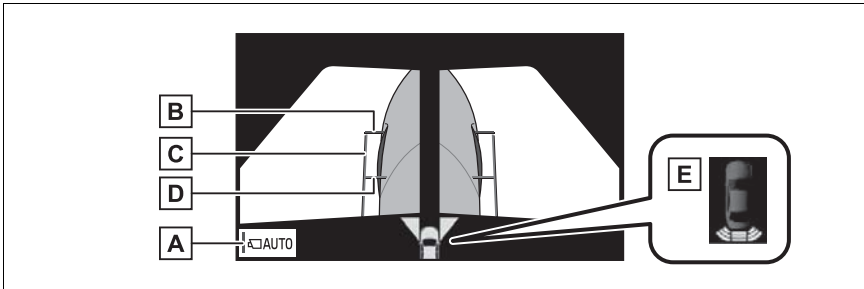

#### **A** Automatic display button

Select to turn automatic display mode on/off. The indicator on the button illuminates during automatic display mode. (→P.189)

#### **B** Front distance guide line (red)

Show distance in front of the vehicle.

- Display points approximately 1.6 ft. (0.5 m) from the edge of the bumper.

#### **C** Vehicle width lines (blue)

Shows guide lines of the vehicle's width including the outside rear view mirrors.

#### **D** Front tire contact line (blue)

Shows guide lines of where the front tire touches the ground.

#### **E** Intuitive parking assist\*

When a sensor detects an obstacle, the direction of and the approximate distance to the obstacle are displayed and the buzzer sounds.

\*: If equipped

- Pressing the camera switch changes the screen to the panoramic view & wide front view screen or previously displayed screen, such as the navigation screen.
- For details about the intuitive parking assist, refer to the “OWNER’S MANUAL”.



### WARNING

- When a sensor indicator on the intuitive parking assist display illuminates in red or a buzzer sounds continuously, be sure to check the area around the vehicle immediately and do not proceed any further until safety has been ensured, otherwise an unexpected accident may occur.
- As the intuitive parking assist display is displayed over the camera view, it may be difficult to see the intuitive parking assist display depending on the color and brightness of the surrounding area.

### Automatic display mode

In addition to screen switching by operating the camera switch, automatic display mode is available. In this mode, the screen is switched automatically in response to vehicle speed.

Each time  is selected, automatic display mode is enabled/disabled.

In automatic display mode, the monitor will automatically display images in the following situations:

- Vehicles with an automatic transmission: When the shift lever is shifted to “N” or “D” position.
- Vehicles with a manual transmission: When the shift lever is in a position other than “R” and the vehicle starts moving.
- When vehicle speed is

reduced to approximately 6 mph (10 km/h) or less.

### Using the vehicle width lines

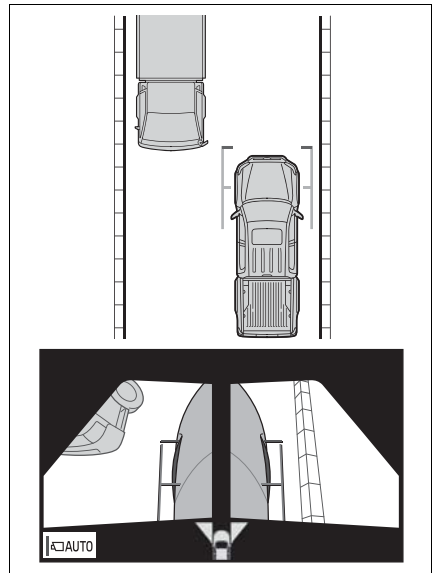

- Check the positions and distance between the vehicle width line and a target object such as the obstacle or curb

of the road.

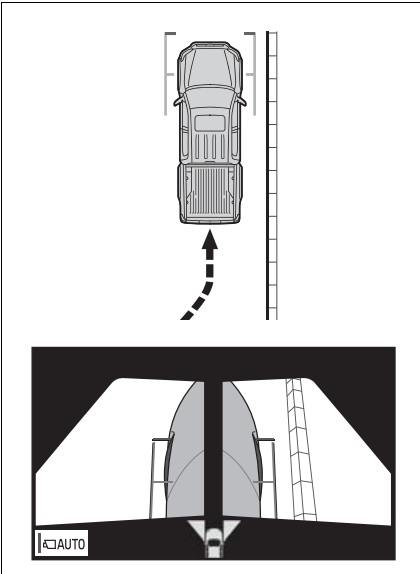

- Pull over to the curb as shown in the illustration above, taking care not to let the vehicle width line overlap the target object.
- Ensure that the vehicle width line is parallel to the target object.

## Checking the rear and around the vehicle

The panoramic view & rear view and the wide rear view screen provide support when checking the areas of behind the vehicle and around the vehicle while backing up, for example while parking.

The screens will be displayed when the shift lever is in the “R” position.

## Screen display

Each time the display mode switching button is selected, the mode will change as follows:

### ► Panoramic view & rear view

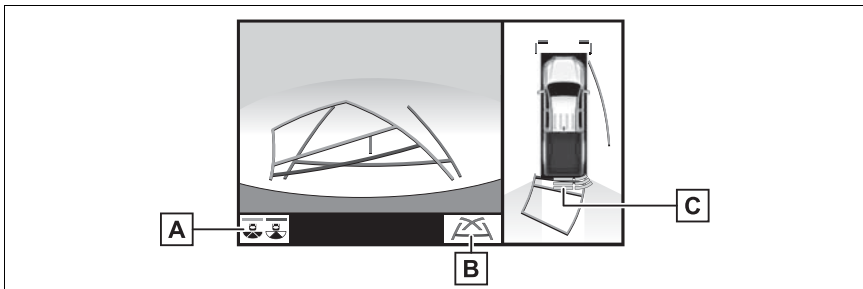

### ► Wide rear view

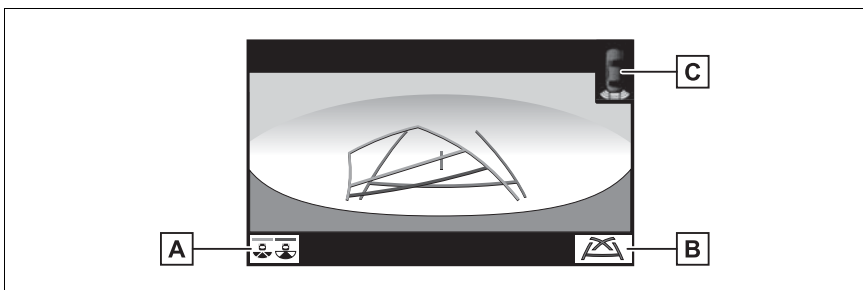

#### **A** Display mode switching button

Select to switches between panoramic view & rear view display and wide rear view display.

#### **B** Guide line switching button

Select to switch the guide line mode. (→P.192)

**C** Intuitive parking assist\*

When a sensor detects an obstacle, the direction of and the approximate distance to the obstacle are displayed and the buzzer sounds.

\*: If equipped

- The monitor is cancelled when the shift lever is shifted into any position other than the “R” position.
- For details about the intuitive parking assist, refer to the “OWNER’S MANUAL”.

**⚠ WARNING**

- When a sensor indicator on the intuitive parking assist display illuminates in red or a buzzer sounds continuously, be sure to check the area around the vehicle immediately and do not proceed any further until safety has been ensured, otherwise an unexpected accident may occur.
- As the intuitive parking assist display is displayed over the camera view, it may be difficult to see the intuitive parking assist display depending on the color and brightness of the surrounding area.

**Guide lines displayed on the screen**

Each time the guide line switching button is selected, the mode will change as follows:

▶ Projected course line

Projected course lines are displayed which move in accordance with the operation of the steering wheel.

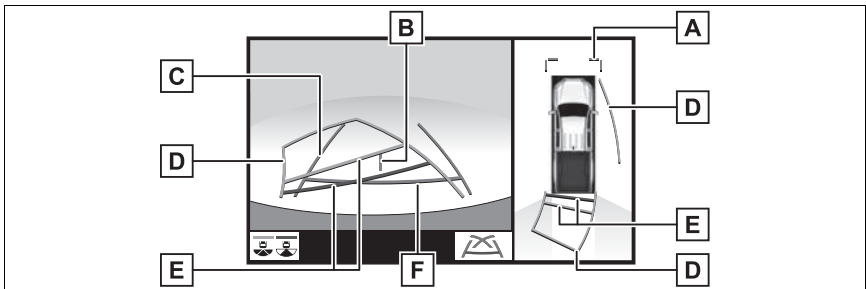

▶ Parking assist guide line

The steering wheel return points (parking assist guide lines) are displayed. This mode is recommended for those who are comfortable with parking the vehicle without the aid of the estimated course lines.

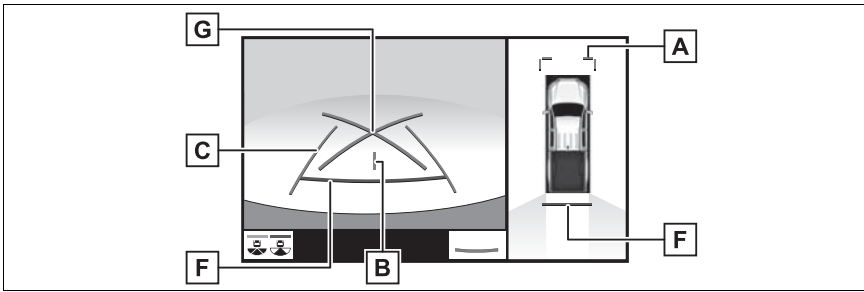

► Distance guide line

Only distance guide line is displayed. This mode is recommended for those who are comfortable with parking the vehicle without the aid of the guide lines.

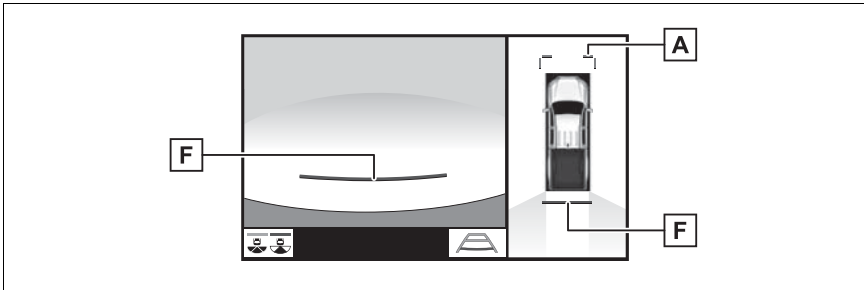

**A** Front distance guide line (blue)

Shows distance in front of the vehicle.

- Display points approximately 3 ft. (1 m) from the edge of the bumper.

**B** Vehicle center line (blue)

The line indicates the estimated vehicle center on the ground.

**C** Rear vehicle width extension guide lines

Displays a guide path when the vehicle is being backed straight up.

**D** Projected reverse course line (yellow)

Shows an estimated course when the steering wheel is turned.

**E** Rear distance guide line

Shows the distance behind the vehicle when the steering wheel is turned.

- The guide lines move in conjunction with the estimated course lines.
- The guide lines display points approximately 1.5 ft. (0.5 m) (red) and approximately 3 ft. (1 m) (yellow) from the center of the edge of the bumper.

**F** Rear distance guide line (blue)

Shows the distance behind the vehicle.

- Displays a point approximately 1.5 ft. (0.5 m) (red/blue) from the edge of the bumper.

**G** Parking assist guide line (blue)

Shows the path of the smallest turn possible behind the vehicle.

**⚠ WARNING**

- Depending on the circumstances of the vehicle (number of passengers, amount of luggage, etc.), the position of the guide lines displayed on the screen may change. Be sure to check visually around the vehicle before proceeding.
- If the steering wheel is straight and the vehicle width guide lines and the estimated course lines are not in alignment, have the vehicle inspected by your Toyota dealer.
- Do not use the system if the display is incorrect due to an uneven (hilly) road or a non-straight (curvy) road.

**Parking**

**Using the projected reverse course line**

When parking in a space which is in the reverse direction to the space described in the procedure below, the steering directions will be reversed.

- 1 Shift the shift lever to the “R” position.
- 2 Turn the steering wheel so that the estimated course

lines are within the parking space, and back up slowly.

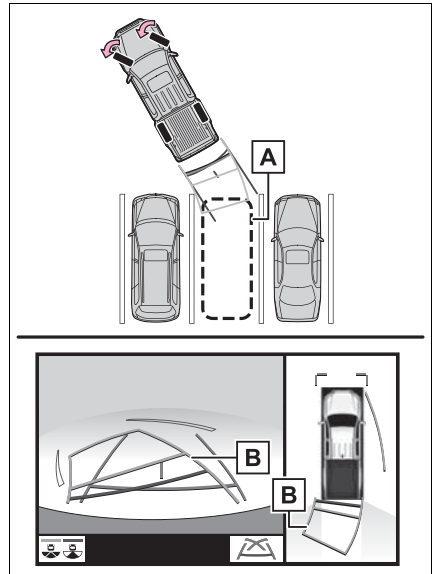

**A** Parking space

**B** Projected reverse course lines



- 3 When the rear position of the vehicle has entered the parking space, turn the steering wheel so that the vehicle width guide lines are within the left and right dividing lines of the parking space.

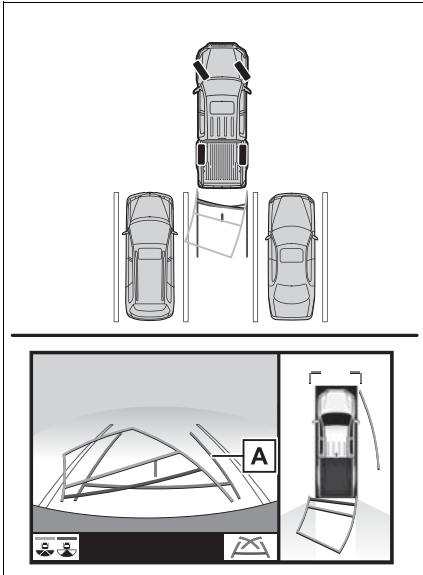

- A** Rear vehicle width extension guide line
- 4 Once the vehicle width guide lines and the parking space lines are parallel, straighten the steering wheel and back up slowly until the vehicle has completely entered the parking space.
- 5 Stop the vehicle in an appropriate place, and finish parking.

### Using parking assist guide line

When parking in a space which is in the reverse direction to the space described in the procedure below, the steering directions will be reversed.

- 1 Shift the shift lever to the "R" position.
- 2 Back up until the parking assist guide line meets the edge of the left-hand dividing line of the parking space.

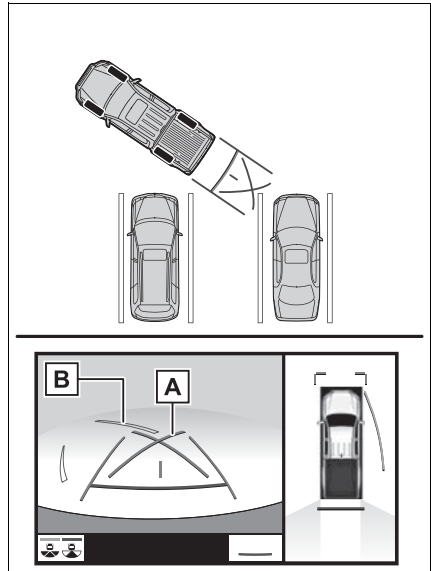

- A** Parking assist guide line
- B** Parking space dividing line
- 3 Turn the steering wheel all the way to the right, and back up slowly.
  - 4 Once the vehicle is parallel with the parking space,

straighten the steering wheel and back up slowly until the vehicle has completely entered the parking space.

- 5 Stop the vehicle in an appropriate place, and finish parking.

## Panoramic view monitor precautions

### Driving precautions

The panoramic view monitor is a supplemental device intended to assist the driver when checking around the vehicle. When using, be sure to visually check all around the vehicle both directly and using the mirrors before proceeding. If you do not, you may hit another vehicle or possibly cause an accident.

Pay attention to the following precautions when using the panoramic view monitor.



#### WARNING

- Never depend on the panoramic view monitor entirely. The image and the position of the guide lines displayed on the screen may differ from the actual state. Use caution just as you would when driving any other vehicle.
- Always make sure to check all around the vehicle with your own eyes when driving.
- Never drive while looking only at the screen as the image on the screen is different from actual conditions. If you are driving while looking only at the screen, you may hit a person or an object, resulting in an accident. When driving, be sure to check the vehicle's surroundings with your own eyes and the vehicle's mirrors.

**WARNING**

- Depending on the circumstances of the vehicle (number of passengers, amount of luggage, etc.), the position of the guide lines displayed on the screen may change. Be sure to check visually around the vehicle before proceeding.
- Do not use the panoramic view monitor system in the following cases:
  - On icy or slick road surfaces, or in snow
  - When using tire chains or emergency tires
  - When the front door or tailgate is not closed completely
  - On roads that are not flat or straight, such as curves or slopes
  - If the suspension has been modified or tires of a size other than specified are installed
- In low temperatures, the screen may darken or the image may become faint. The image could distort when the vehicle is moving, or you may become unable to see the image on the screen. Be sure to visually check all around the vehicle both directly and using the mirrors before proceeding.
- If the tire sizes are changed, the position of the guide lines displayed on the screen may change.
- The camera uses a special lens. The distances between objects and pedestrians that appear in the image displayed on the screen will differ from the actual distances. (→P.202)

**NOTICE**

- In panoramic view, the system combines images taken from the front, back, left and right side cameras into a single image. There are limits to the range and content that can be displayed. Familiarize yourself with the characteristics of the panoramic view monitor system before using it.
- Image clarity may decline at the four corners of the panoramic view. However, this is not a malfunction, as these are the regions along the border of each camera image where the images are combined.
- Depending on lighting conditions near each of the cameras, bright and dark patches may appear on the panoramic view.
- The panoramic view display does not extend higher than the installation position and image capture range of each camera.
- There are blind spots around the vehicle. Accordingly, there are regions not displayed in panoramic view.
- Three-dimensional objects displayed in side view, wide front view or rear view may not be displayed in panoramic view.
- People and other three-dimensional obstacles may appear differently when displayed on the panoramic view monitor. (These differences include, among others, cases in which displayed objects appear to have fallen over, disappear near image processing areas, appear from image processing areas, or when the actual distance to an object differs from the displayed position.)

 NOTICE

- When the tailgate, which is equipped with the back camera, or front doors, which are equipped with door mirrors that have built-in side cameras, are open, images will not be displayed properly on the panoramic view monitor.
- The vehicle icon displayed in panoramic view is a computer generated image. Accordingly, properties such as the color, shape and size will differ from the actual vehicle. For this reason, nearby three-dimensional objects may appear to be touching the vehicle, and actual distances to three-dimensional objects may differ from those displayed.

**Area displayed on screen**

**Area of image of panoramic view**

Since the panoramic view processes and displays images based on flat road surfaces, it cannot depict the position of three-dimension objects (such as vehicle bumpers, etc.) that are in positions higher than the surface of the road. Even if there is room between the bumpers of the vehicles and it seems not likely to collide in the image, in reality, the both vehicles are on a collision course.

Check the safety of the surroundings directly.

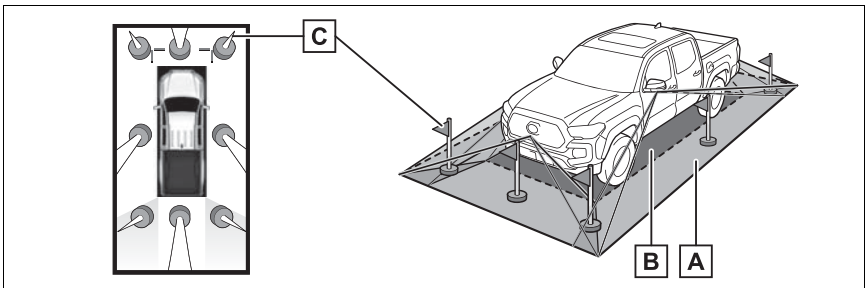

**A** The area displayed on the screen

**B** The area not displayed on the screen

- Objects located in the shaded areas will not be displayed on the screen.

**C** The parts of objects not displayed on the screen

- Parts of objects which extend above a certain height cannot be displayed on the screen.

- As the images obtained from four cameras are processed and displayed on the standard of a flat road surface; the panoramic view may be displayed as follows.
- Objects may look collapsed; thinner or bigger than usual.
- An object with a higher position than the road surface may look farther away than it actually is or may not appear at all.
- Tall objects may appear protruding from the non-displayed areas of the image.
- Variations in the brightness of the image may appear for every camera.
- The displayed image may be shifted by inclination of the vehicle body, change in vehicle height, etc., depending on the number of passengers, amount of luggage, fuel quantity, etc.
- If the front doors or tailgate are not completely closed; neither the image nor the guide lines are displayed.
- The position relations of the vehicle icon and the road surface or obstacle may differ from the actual positions.
- The black areas of the vicinity of the vehicle icon are areas that are not captured by the camera.
- Images like the following are combined, thus some areas may be difficult to view.

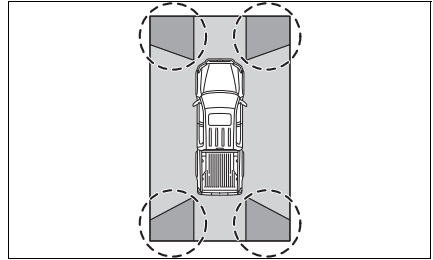

### Area of the image captured by the camera

#### ► Wide front view

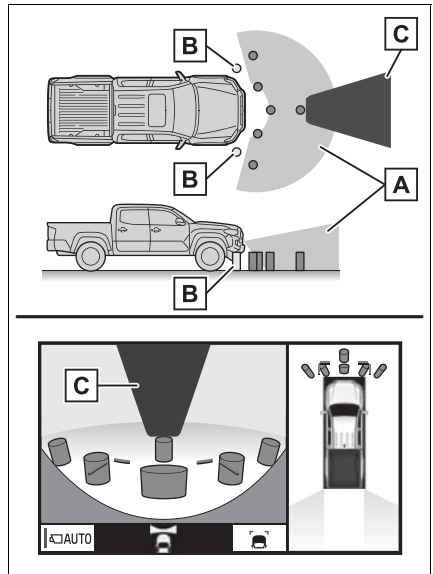

▶ Side views

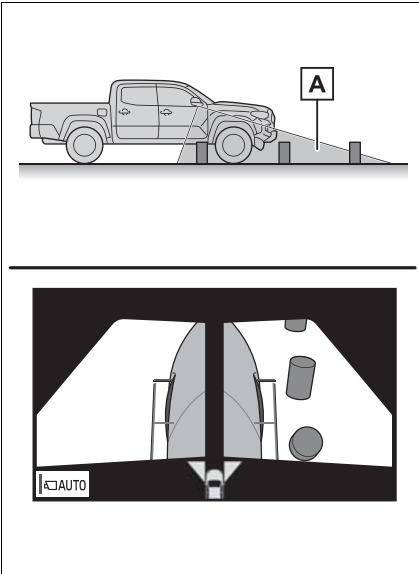

▶ Wide rear view

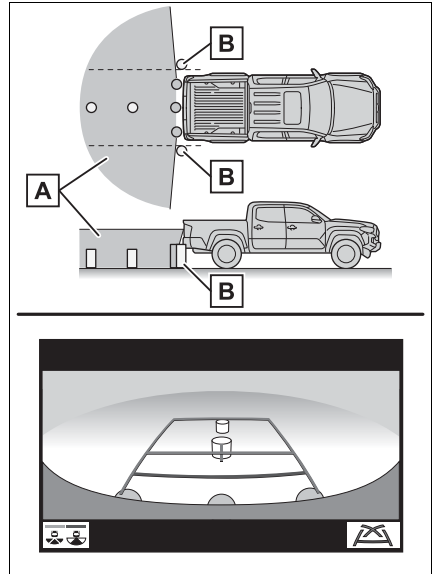

▶ Rear view

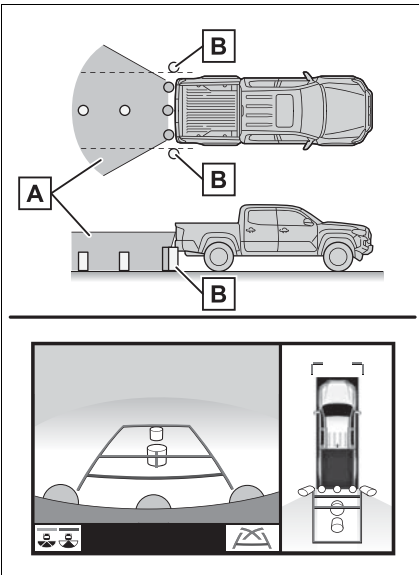

**A** The area displayed on the screen

**B** The objects not displayed on the screen

**C** Black masking

- Black masking is done for distance detection differences to the front of the vehicle.
- The area covered by the camera is limited. Objects which are close to either corner of the bumper or under the bumper cannot be seen on the screen.
- The area displayed on the screen may vary depending on vehicle orientation or road conditions.
- The camera uses a special lens. The distance in the image displayed on the screen will differ from the actual distance.

## The camera

The cameras for the panoramic view monitor are located as shown in the illustration.

### ▶ Front camera

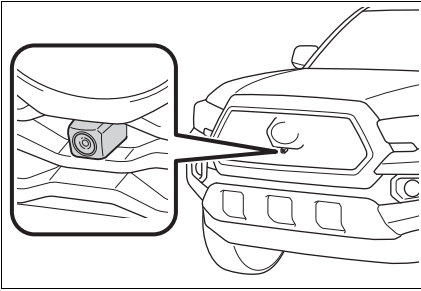

### ▶ Side cameras

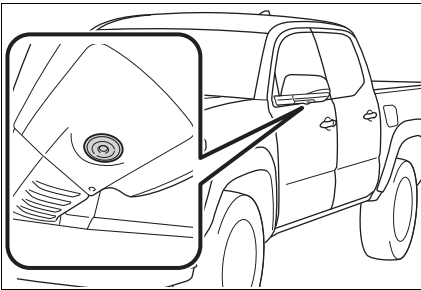

### ▶ Rear camera

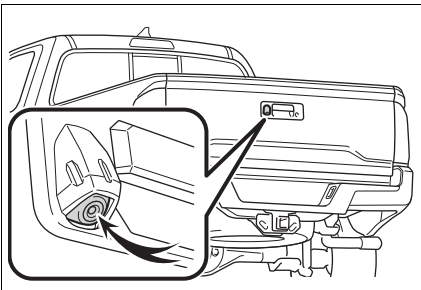

## ■ Using the camera

If dirt or foreign matter (such as water droplets, snow, mud etc.) is adhering to the camera, it cannot transmit a clear image.

In this case, flush it with a large quantity of water and wipe the camera lens clean with a soft and wet cloth.

### ⚠ NOTICE

- The panoramic view monitor may not operate properly in the following cases.
  - If the camera is hit, the position and mounting angle of the camera may change.
  - As the camera has a water proof construction, do not detach, disassemble or modify it. This may cause incorrect operation.
  - When cleaning the camera lens, flush the camera with a large quantity of water and wipe it with a soft and wet cloth. Strongly rubbing the camera lens may cause the camera lens to be scratched and unable to transmit a clear image.
  - Do not allow an organic solvent, car wax, window cleaner or a glass coating to adhere to the camera. If this happens, wipe it off as soon as possible.
  - If the temperature changes rapidly, such as when hot water is poured on the vehicle in cold weather, the system may not operate normally.
  - When washing the vehicle, do not apply intensive bursts of water to the camera or camera area. Doing so may result in the camera malfunctioning.
- Do not expose the camera to strong impacts as this could cause a malfunction. If this happens, have the vehicle inspected by your Toyota dealer as soon as possible.

## Differences between the screen and the actual road

- The distance guide lines and the vehicle width guide lines may not actually be parallel with the dividing lines of the parking space, even when they appear to be so. Be sure to check visually.
- The distances between the vehicle width guide lines and the left and right dividing lines of the parking space may not be equal, even when they appear to be so. Be sure to check visually.
- The distance guide lines give a distance guide for flat road surfaces. In any of the following situations, there is a margin of error between the guide lines on the screen and the actual distance/course on the road.

### ■ When the ground behind the vehicle slopes up sharply

The distance guide lines will appear to be closer to the vehicle than the actual distance. Because of this, objects will appear to be farther away than they actually are. In the same way, there will be a margin of error between the guidelines and the actual distance/course on the road.

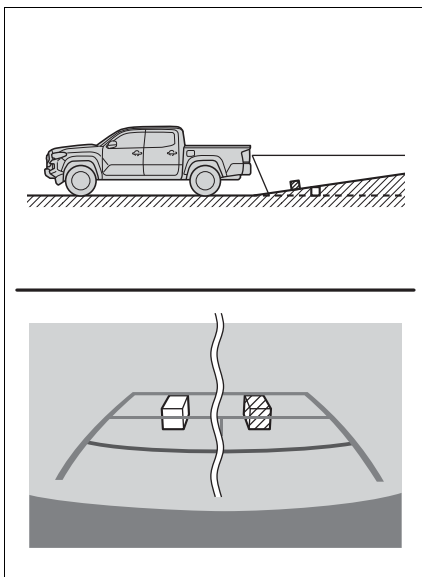

### ■ When the ground behind the vehicle slopes down sharply

The distance guide lines will appear to be farther from the vehicle than the actual distance. Because of this, objects will appear to be closer than they actually are. In the same way, there will be a margin of error between the guidelines and the actual distance/course on the road.



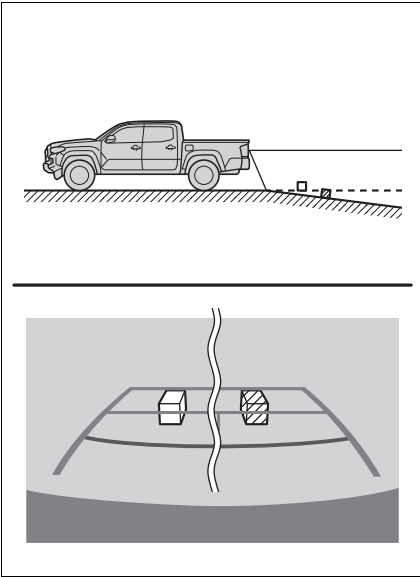

### ■ When any part of the vehicle sags

When any part of the vehicle sags due to the number of passengers or the distribution of the load, there is a margin of error between the guide lines on the screen and the actual distance/course on the road.

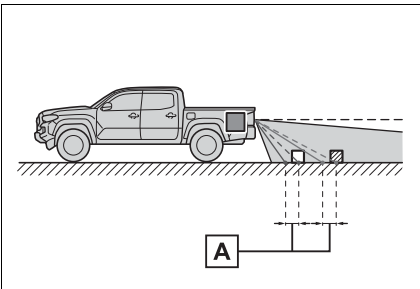

**A** A margin of error

### When approaching three-dimensional objects

When there are three-dimensional objects (such as vehicle bumpers, etc.) nearby in positions higher than the surface of the road, take extra care when using the following.

#### ⚠ WARNING

- When a sensor indicator on the intuitive parking assist display illuminates in red or a buzzer sounds continuously, be sure to check the area around the vehicle immediately and do not proceed any further until safety has been ensured, otherwise an unexpected accident may occur.

### Panoramic view display

Since the panoramic view process and display images based on flat road surfaces, it cannot depict the position of three-dimension objects (such as vehicle bumpers, etc.) that are in positions higher than the surface of the road. For example, even though it appears that there is space between the bumpers of the two vehicles in the illustration below and they are not likely to collide, in reality, a collision is about to occur.

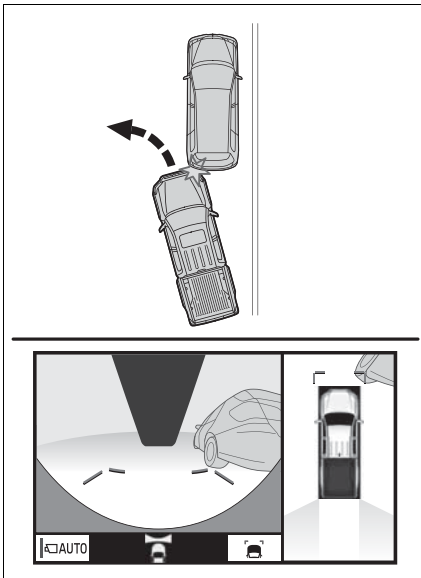

### Projected course lines

- Since the projected course lines is displayed for a flat road surface, it can not depict the position of three-dimensional objects (such as vehicle bumpers, etc.) that are in positions higher than the surface of the road. Even if the bumpers of the vehicle is on the outside of the projected course lines in the image, in reality, the vehicles are on a collision course.

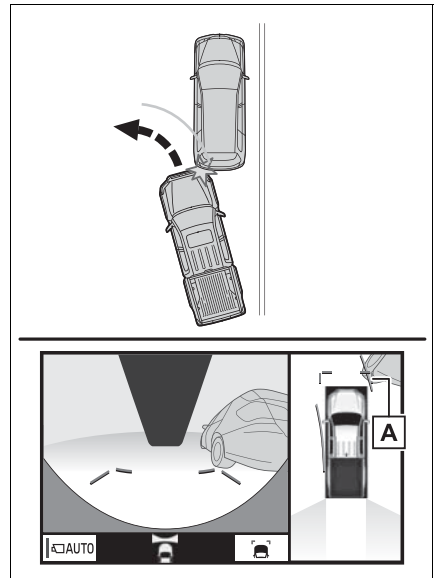

### A Projected course lines

- Three-dimensional objects (such as the overhang of a wall or loading platform of a truck) in high positions may not be projected on the screen. Check the safety of the surroundings directly.

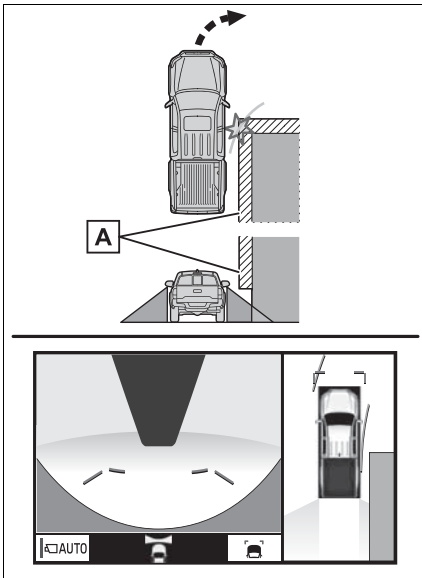

**A** The overhang of a wall

- Visually check the surroundings and the area behind the vehicle. In the case shown below, the truck appears to be outside of the projected course lines and the vehicle does not look as if it hits the truck. However, the rear body of the truck may actually cross over the projected course lines. In reality if you back up as guided by the estimated course lines, the vehicle may hit the truck.

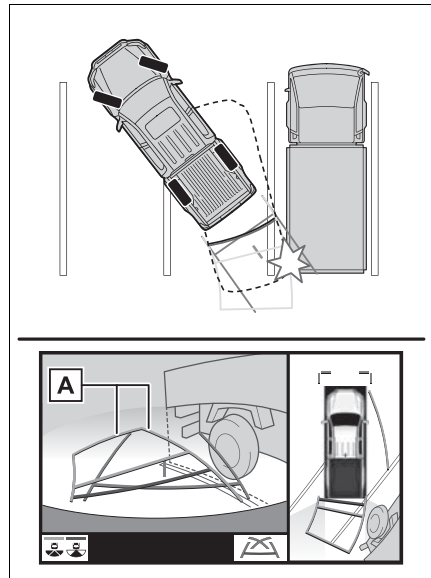

**A** Projected course lines

### Distance guide lines

Visually check the surroundings and the area behind the vehicle. On the screen, it appears that a truck is parking at point **B**. However, in reality if you back up to point **A**, you will hit the truck. On the screen, it appears that **A** is closest and **C** is farthest away. However, in reality, the distance to **A** and **C** is the same, and **B** is farther than **A** and **C**.

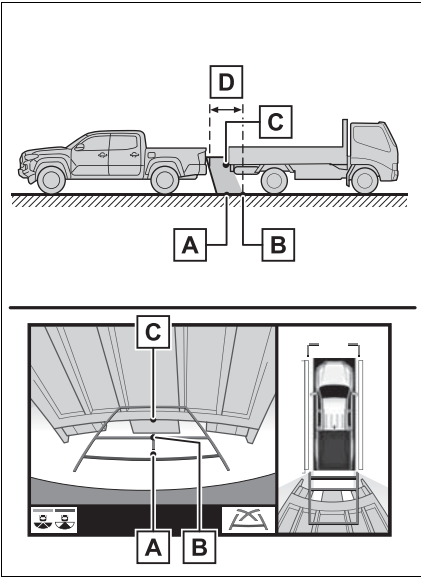

**D** Approx. 3 ft. (1 m)

## Things you should know

### If you notice any symptoms

If you notice any of the following symptoms, refer to the likely cause and the solution, and re-check.

If the symptom is not resolved by the solution, have the vehicle inspected by your Toyota dealer.

Symptom	Likely cause	Solution
The image is difficult to see	<ul style="list-style-type: none"> <li>• The vehicle is in a dark area</li> <li>• The temperature around the lens is either high or low</li> <li>• The outside temperature is low</li> <li>• There are water droplets on the camera</li> <li>• It is raining or humid</li> <li>• Foreign matter (mud etc.) is adhering to the camera</li> <li>• Sunlight or headlights are shining directly into the camera</li> <li>• The vehicle is under fluorescent lights, sodium lights, mercury lights etc.</li> </ul>	<p>Back up while visually checking the vehicle's surroundings. (Use the monitor again once conditions have been improved.)</p> <p>The procedure for adjusting the picture quality of the panoramic view monitor system is the same as the procedure for adjusting the navigation screen. (→P.33)</p>
The image is blurry	Dirt or foreign matter (such as water droplets, snow, mud etc.) is adhering to the camera.	Flush the camera with a large quantity of water and wipe the camera lens clean with a soft and wet cloth.
The image is out of alignment	The camera or surrounding area has received a strong impact.	Have the vehicle inspected by your Toyota dealer.

Symptom	Likely cause	Solution
The guide lines are very far out of alignment	The camera position is out of alignment.	Have the vehicle inspected by your Toyota dealer.
	<ul style="list-style-type: none"> <li>• The vehicle is tilted. (There is a heavy load on the vehicle, tire pressure is low due to a tire puncture, etc.)</li> <li>• The vehicle is used on an incline.</li> </ul>	<p>If this happens due to these causes, it does not indicate a malfunction.</p> <p>Back up while visually checking the vehicle's surroundings.</p>
The estimated course lines move even though the steering wheel is straight	There is a malfunction in the signals being output by the steering sensor.	Have the vehicle inspected by your Toyota dealer.
Guide lines are not displayed	The tailgate is open.	<p>Close the tailgate.</p> <p>If this does not resolve the symptom, have the vehicle inspected by your Toyota dealer.</p>
 is displayed	<ul style="list-style-type: none"> <li>• Battery has been reinstalled.</li> <li>• The steering wheel has been moved while the battery was being reinstalled.</li> <li>• Battery power is low.</li> <li>• The steering sensor has been reinstalled.</li> <li>• There is a malfunction in the signals being output by the steering sensor.</li> </ul>	<p>Stop the vehicle, and turn the steering wheel as far as it will go to the left and right.</p> <p>If this does not resolve the symptom, have the vehicle inspected by your Toyota dealer.</p>

## Multi-terrain Monitor\*

\*: If equipped

**The Multi-terrain Monitor helps the driver to check the vehicle surroundings. It assists in determining the conditions around the driver in a variety of situations, such as when judging conditions during off-road driving or checking for obstacles when parking.**



### WARNING

Observe the following precautions to avoid an accident that could result in death or serious injuries.

#### ■ When using the Multi-terrain Monitor system

- Never rely solely on the Multi-terrain Monitor. As with unequipped vehicles, drive carefully while directly confirming the safety of your surroundings and the area to the rear of the vehicle. Take particular care to avoid parked cars and other obstacles.
- Due to the characteristics of the camera lens, the actual position and distance of people and other obstacles will differ from those shown on the Multi-terrain Monitor screen. Directly confirm the safety of your surroundings before driving.
- Do not drive while only looking at the screen. When driving, make sure to directly confirm the safety of your surroundings, such as by visually checking the area and using the vehicle's mirrors.

- In low temperatures, the screen may darken or the images may become faint. Images of moving objects in particular may distort or disappear from the screen. Therefore, make sure to drive carefully while directly visually confirming the safety of your surroundings.

## Displaying the Multi-terrain Monitor screen

The Multi-terrain Monitor screen will be displayed when the camera switch is pressed while the engine switch is in ON.

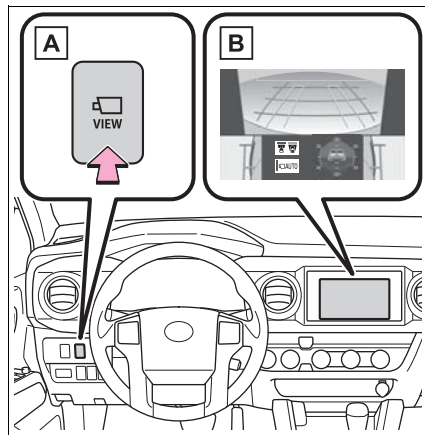

**A** Camera switch

**B** Display

- The Multi-terrain Monitor is displayed by operating the camera switch when vehicle speed is approximately 7 mph (12 km/h) or less.

### Screens when the front-wheel drive control switch is in 4L (for off-road)

The front-wheel drive control switch in the case of 4L, the multi-terrain monitor can display a screen suitable for off-road.

- The driver can drive while confirming the following guidelines with a front view
  - Distance with the obstacle in the front
  - Estimated course line
- The driver can drive while confirming the obstacle in the flank of tire neighborhood and the vehicle with a side screen

### Checking the area to the front and sides of the vehicle

- ▶ Front view & dual side view (→P.213)

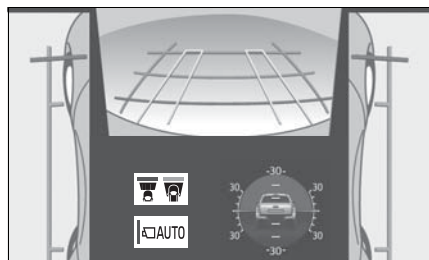

### Checking the condition of the road surface under the vehicle

- ▶ Under vehicle terrain view & dual side view (→P.213)

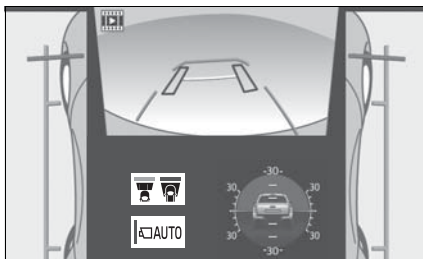

### Checking the area to the rear of the vehicle

- ▶ Rear view & dual side view (→P.213)



- ▶ Wide rear view (→P.213)





### Screens when the front-wheel drive control switch is in 2WD or 4H (for on-road)

The front-wheel drive control switch in the case of 2WD or 4H, the multi-terrain monitor can display a screen suitable for on-road.

- The multi-terrane monitor does a screen division into two of right and left and displays it.
- Left side screen: Front view or rear view
- Right side screen: Panoramic view

In addition, even both side views, wide rear view can identify the obstacle around the vehicle.

### Checking the front and around the vehicle

- ▶ Panoramic view & wide front view (→P.215)

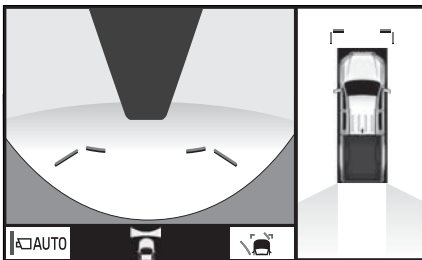

### Checking the sides of the vehicle

- ▶ Side views (→P.215)

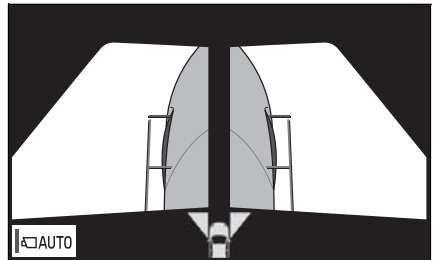

### Checking the rear and around the vehicle

- ▶ Panoramic view & rear view (→P.215)

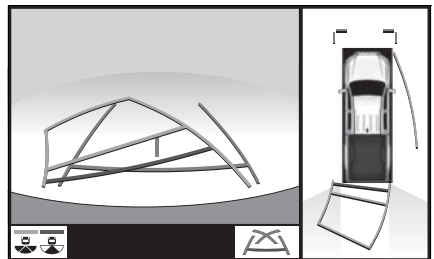

- ▶ Wide rear view (→P.215)

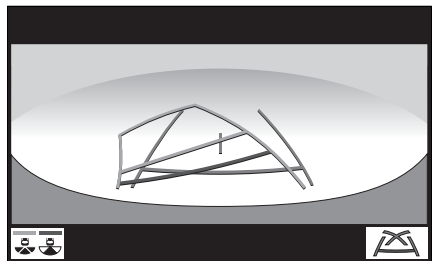



### Automatic display mode

When automatic display mode is turned on, the Multi-terrain Monitor screen is displayed in the following conditions, even if the

camera switch has not been operated.

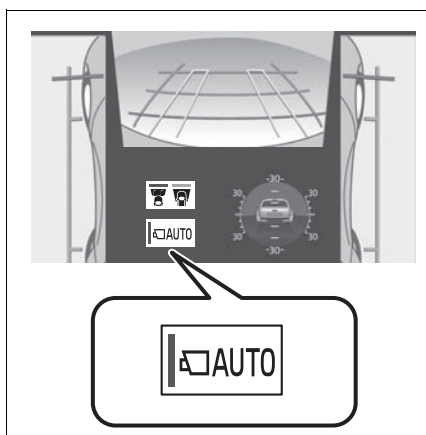
- Vehicles with an automatic transmission: When the shift lever is shifted to “N” or “D” position.
- Vehicles with a manual transmission: When the shift lever is in a position other than “R” and the vehicle starts moving.
- When vehicle speed is reduced to approximately 6 mph (10 km/h) or less.



- The automatic display mode switches between on and off each time  is selected. When automatic display mode is on, an indicator illuminates on the icon.
- Even when automatic display mode is on, the display can still be switched by pressing the camera switch.

## Changing the Multi-terrain Monitor screen

The screen display can be switched by operating the switches as follows while the Multi-terrain Monitor screen is displayed. (Screens that can be displayed will vary depending on the positions of the shift lever and front-wheel drive control switch)

- The Multi-terrain Monitor is displayed by operating the camera switch when vehicle speed is approximately 7 mph (12 km/h) or less. If the vehicle speed exceeds approximately 7 mph (12 km/h), the Multi-terrain Monitor display is canceled.

### Screens when the front-wheel drive control switch is in 4L (for off-road)

- ▶ When the shift lever is in a position other than “R”

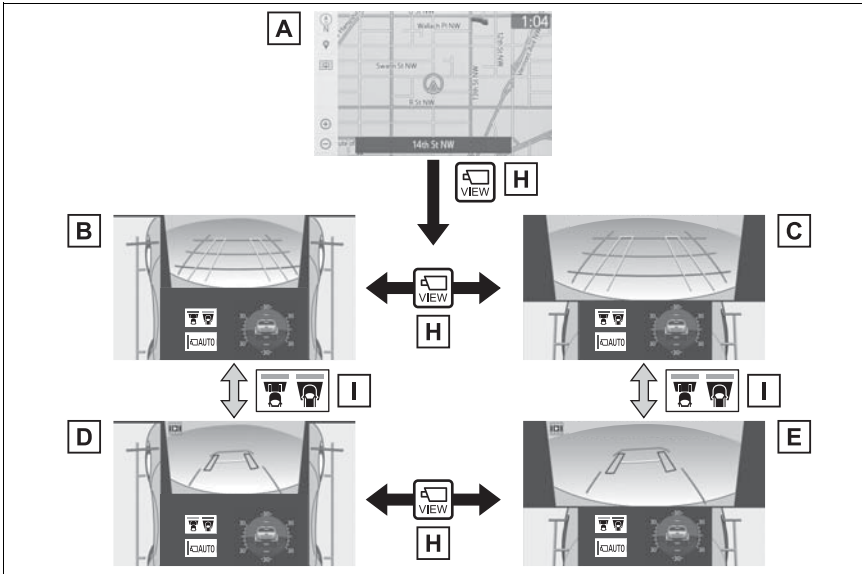

▶ When the shift lever is in the “R” position

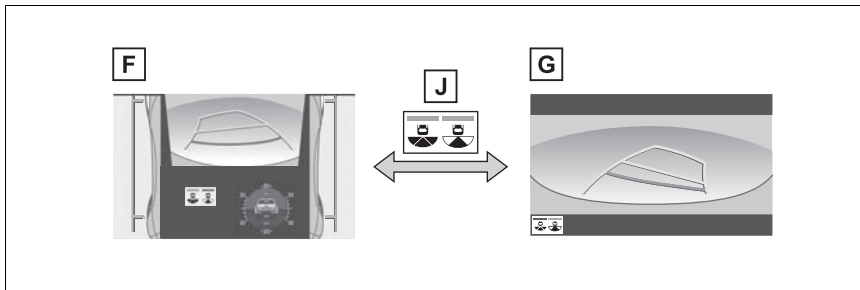

- A** Map screen, audio screen, etc.
- B** Front view & dual side view
- C** Front view & dual side view (front magnified)
- D** Under vehicle terrain view & dual side view
- E** Under vehicle terrain view & dual side view (front magnified)
- F** Rear view & dual side view
- G** Wide rear view
- H** Pressing the camera switch
- I** Selecting the under vehicle terrain view selection button \*
- J** Selecting the display mode switching button \*

\*: The screen display can be switched by touching the image from the camera on the screen.

## Screens when the front-wheel drive control switch is in 2WD or 4H (for on-road)

- ▶ When the shift lever is in a position other than “R”

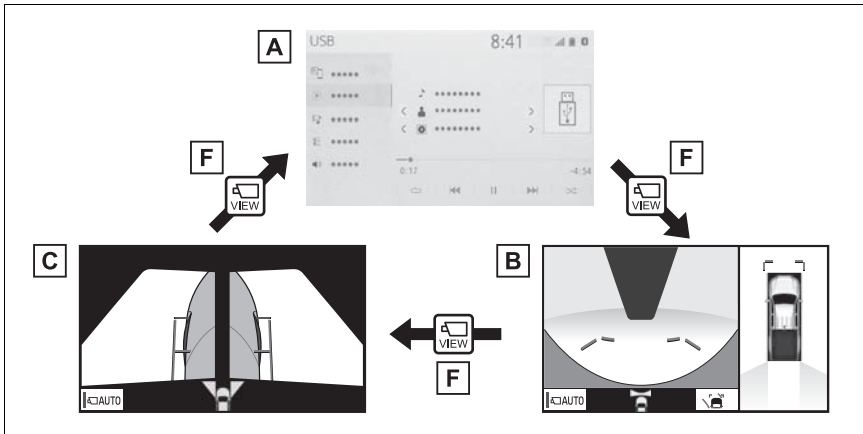

- ▶ When the shift lever is in the “R” position

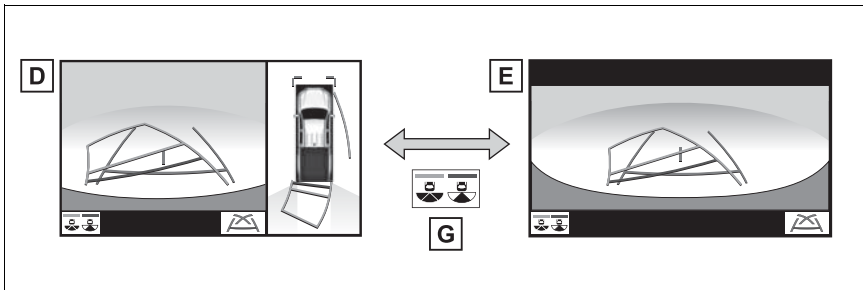

- A** Map screen, audio screen, etc.
- B** Panoramic view & wide front view
- C** Side views
- D** Panoramic view & rear view
- E** Wide rear view
- F** Pressing the camera switch
- G** Selecting the display mode switching button\*

\*: The screen display can be switched by touching the image from the camera on the screen.

## Screen display and functions (for off-road)

The front-wheel drive control switch in the case of 4L, the multi-terrain monitor can display a screen suitable for off-road.

### Front view & dual side view

Front view & dual side view can be used to check the area around the front of the vehicle.

- In addition to an image of the front of the vehicle, guide lines are displayed in a composite view to provide reference for when deciding a direction to move forward in.
- If the camera switch is pressed while the screen is displayed, the screen switches from normal to magnified display. (Pressing the switch again returns the screen to the normal display)
- If the steering wheel is turned 90° or more, guide lines and other features to support turning are automatically displayed.

► Front view & dual side view

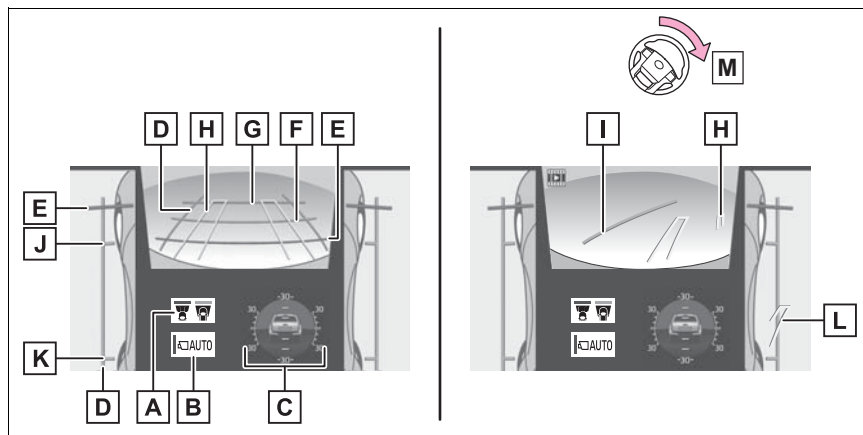

► Front view & dual side view (front magnified)

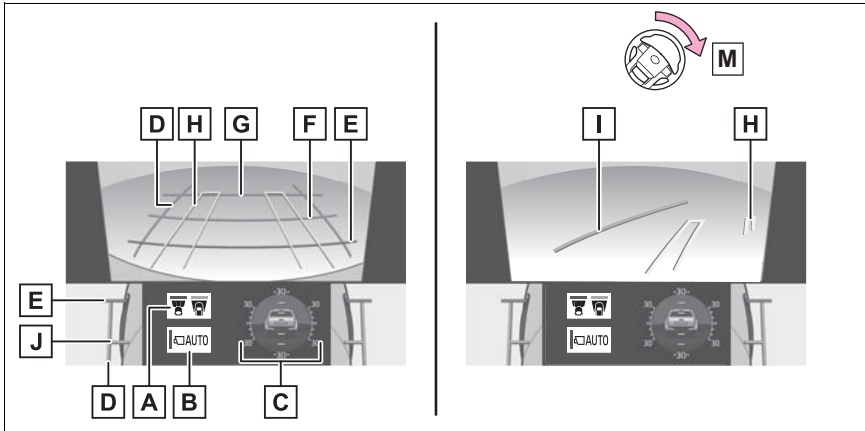

**A** Under vehicle terrain view selection button

Select to switches between front view and under vehicle terrain view.

**B** Automatic display button

Select to turn automatic display mode on/off. The indicator on the button illuminates during automatic display mode. (→P.211)

**C** Tilt meter/slip display

Displays the vehicle's estimated degree of incline or indicates a tire slippage. (→P.218, 219)

**D** Vehicle width lines (blue)

Shows guide lines of the vehicle's width including the outside rear view mirrors.

**E** 1.5 ft. (0.5 m) distance guide line (red)

Show distance in front of the vehicle.

- Display points approximately 1.5 ft. (0.5 m) from the edge of the bumper.

**F** 3 ft. (1 m) distance guide line (blue)

**G** 6 ft. (2 m) distance guide line (blue)

**H** Front tire course line (yellow)

Shows the estimated course of the front tires according to steering wheel position.

**I** Forward movement guide line (blue)

Shows the estimated tire course of the tightest possible turn.

**J** Front tire contact line (blue)

Shows guide lines of where the front tire touches the ground.

**K** Rear tire contact line (blue)

Shows guide lines of where the rear tire touches the ground.

**L** Rear tire course line (yellow)

Shows the estimated course of the rear tires.

**M** When the steering wheel is turned by 90° or more

- The screen can be displayed when the shift lever is in a position other than “R”.
- When the intuitive parking assist detects an obstacle or another vehicle, a warning message pops up in the tilt meter/slip display area.

### Front view rotating display function

This function operates when the front-wheel drive control switch is in 4L. The front view image is automatically adjusted to be parallel and assist the driver to check road surface conditions regardless of the vehicle inclination.

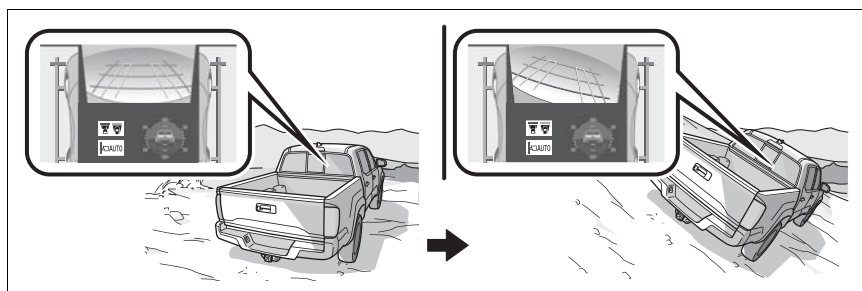

- The vehicle inclination displayed on the screen may differ from the actual state.
- When the rotated screen is displayed, the corners of the front bumper may not be seen on the screen.

### Tilt meter

Tilt meter displays the vehicle inclination to the front, rear, left and right within a range of 0° to approximately 30°.

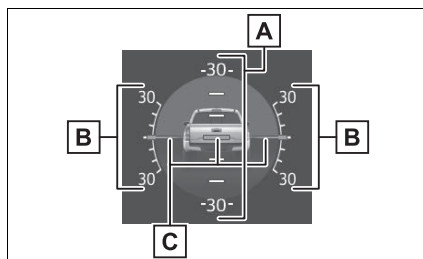



**A** Degree markers of incline to the front and rear

Indicates the vehicle inclination in degrees in the front and rear directions.

**B** Degree markers of incline to the left and right

Indicates the vehicle inclination in degrees in the left and right directions.

**C** Pointer

Indicates the degree of the vehicle inclination in comparison to a parallel line.

- The display indicates the incline of the vehicle in degrees shown by the movement of the pointer and the rotation of the vehicle image.
- The color of the degree markers of incline to the front, rear, left and right changes according to the current incline of the vehicle.
- After the engine switch is in ON, the degree of incline is not displayed until such information is determined.
- The degree of incline showed on the tilt meter is only an approximate indication, and may differ

from the degree of incline measured using other equipment.

### Slip display

When tire slippage is detected, the tilt meter display area is automatically switched to the slip display.

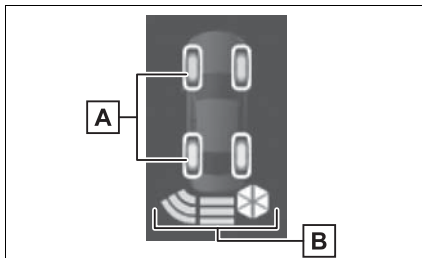

**A** Tire display

Indicates the position of freely spinning tires in yellow if the tire spins. (During Crawl Control is operating, all of the tires are indicated in yellow.)

**B** Pop-up display of the intuitive parking assist

Displayed if an obstacle is detected while the intuitive parking assist is turned on.

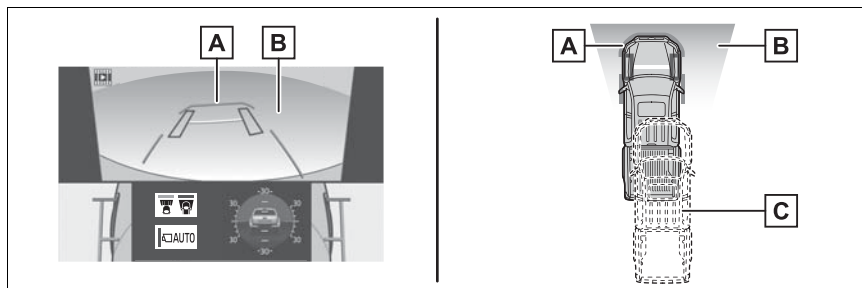

### Under vehicle terrain view & dual side view

Lines indicating current vehicle and tire position are displayed in a composite view on an image taken approximately 10 ft. (3 m) behind the current vehicle position and assists the driver to check conditions underneath the vehicle or determine the position of the front tires.



- A** Current vehicle position
- B** Image displayed in the under vehicle terrain view (image taken approximately 10 ft. (3 m) behind the current vehicle position)
- C** Vehicle position at the time the image was taken (approximately 10 ft. (3 m) behind the current vehicle position)

### Displaying the under vehicle terrain view

While the front view is displayed, stop the vehicle completely, and then press . Pressing  again returns the screen to the front view display.

- If the camera switch is pressed while the screen is displayed, the screen switches from normal to magnified display. (Pressing the switch again returns the screen to the normal display)
- ▶ Under vehicle terrain view & dual side view

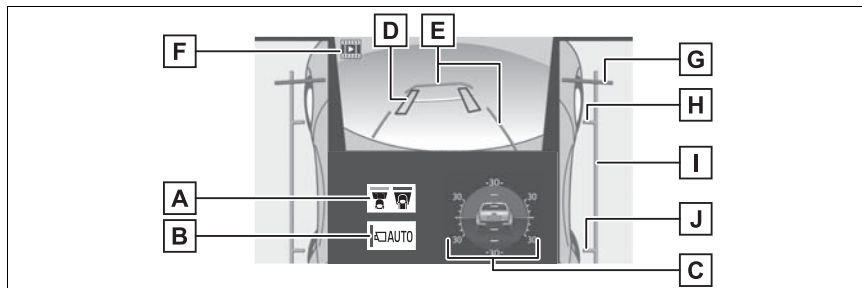

► Under vehicle terrain view & dual side view (front magnified)

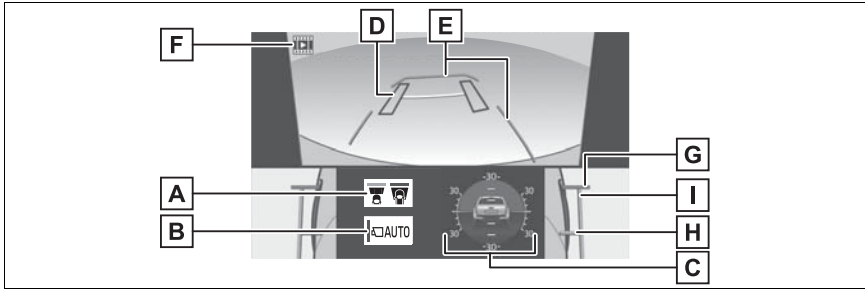

**A** Under vehicle terrain view selection button

Select to switch between front view and under vehicle terrain view.

**B** Automatic display button

Select to turn automatic display mode on/off. The indicator on the button illuminates during automatic display mode. (→P.211)

**C** Tilt meter/slip display

Displays the vehicle's estimated degree of incline or indicates a tire slip-page. (→P.218, 219)

**D** Tire position indicator lines (black)

Indicates the estimated position of the front tires.

**E** Vehicle position indicator lines (blue)

Indicates the estimated position of the vehicle.

**F** Icon (flashing)

Indicates that the under vehicle terrain view display is of an image taken in the past.

**G** 1.5 ft. (0.5 m) distance guide line (red)

Show distance in front of the vehicle.

- Display points approximately 1.5 ft. (0.5 m) from the edge of the bumper.

**H** Front tire contact line (blue)

Shows guide lines of where the front tire touches the ground.

**I** Vehicle width lines (blue)

Shows guide lines of the vehicle's width including the outside rear view mirrors.

**J** Rear tire contact line (blue)

Shows guide lines of where the rear tire touches the ground.

- The screen can be displayed when the shift lever is in a position other than “R”.
- While the under vehicle terrain view is displayed, if the vehicle speed reaches or exceeds approximately 3 mph (5 km/h), the screen automatically returns to the front view display.
- In the following situations, the under vehicle terrain view selection button cannot be operated.
  - The vehicle is not completely stopped
  - After the engine starts, a fixed distance or more has not been driven
  - After the front-wheel drive control switch is shifted to 4L, a fixed distance or more has not been driven
- In the following situations, the system may not operate normally, or it may not be possible to switch to the under vehicle terrain view.
  - The road is covered with snow
  - It is nighttime and the road has no illumination
  - Dirt or foreign matter is adhering to the camera lens
  - There is water in front of the vehicle (a river, puddle, sea water, etc.)

**WARNING**

- The tire position indicator lines and vehicle position indicator lines may differ from actual vehicle positions depending on the number of passengers, cargo weight, road grade, road surface conditions, brightness of the surrounding environment, etc. Always drive the vehicle while confirming the safety of your surroundings.
- The image displayed is one that was previously taken at a point approximately 10 ft. (3 m) behind the current vehicle position. In cases such as when objects move after the image is taken, the image displayed on the screen may differ from the actual state.

**Rear view & dual side view/wide rear view**

The rear view & dual side view/wide rear view screen provide support when checking the areas of behind the vehicle and around the vehicle while backing up, for example while parking.

The screens will be displayed when the shift lever is in the “R” position.

► Rear view & dual side view

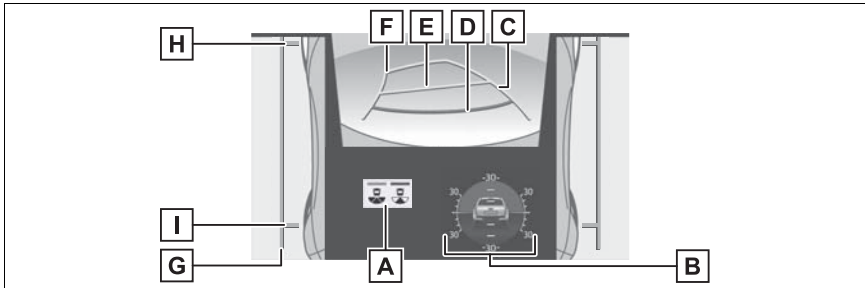

► Wide rear view

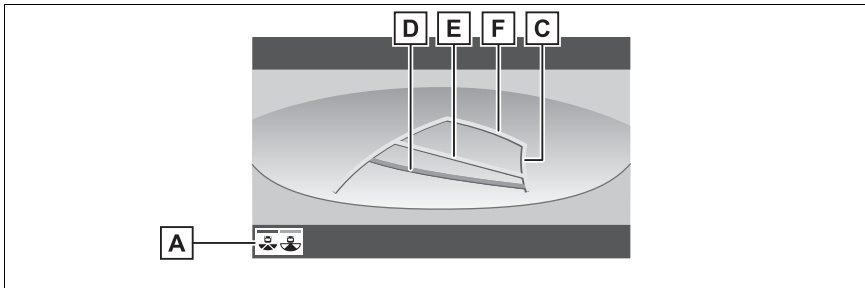

**A** Display mode switching button

Select to switches between rear view & dual side view and wide rear view.

**B** Tilt meter/slip display

Displays the vehicle's estimated degree of incline or indicates a tire slip-page. (→P.218, 219)

**C** Projected course lines (yellow)

Shows the estimated course of the vehicle according to steering operations.

**D** 1.5 ft. (0.5 m) distance guide line (red)

Show distance in rear of the vehicle.

- Display points approximately 1.5 ft. (0.5 m) from the edge of the bumper.

**E** 3 ft. (1 m) distance guide line (yellow)

**F** 8 ft. (2.5 m) distance guide line (yellow)

**G** Vehicle width extension guide line (blue)

Shows guide lines of the vehicle's width including the outside rear view mirrors.

**H** Front tire contact line (blue)

Shows guide lines of where the front tire touches the ground.

**I** Rear tire contact line (blue)

Shows guide lines of where the rear tire touches the ground.

- 
- The screen can be displayed when the shift lever is in “R”.
  - If the tailgate is not closed, guide lines will not be displayed. If the guide lines do not display even when the tailgate is closed, have the vehicle inspected at your Toyota dealer.

**WARNING**

- The tire position indicator lines and vehicle position indicator lines may differ from actual vehicle positions depending on the number of passengers, cargo weight, road grade, road surface conditions, brightness of the surrounding environment, etc. Always drive the vehicle while confirming the safety of your surroundings.

## Screen display and functions (for on-road)

The front-wheel drive control switch in the case of 2WD or 4H, the multi-terrain monitor can display a screen suitable for on-road.

### Panoramic view & wide front view

The panoramic view & wide front view screen provides support when checking the areas in front of the vehicle and around the vehicle when taking-off at T-intersections or other intersections during poor visibility.

#### ► Panoramic view & wide front view

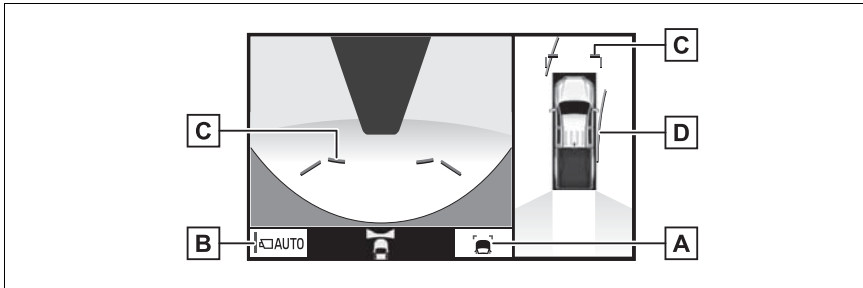

#### **A** Guide line switching button

Select to change the guide line mode between the distance guide line display mode and the estimated course line display mode. (→P.226)

#### **B** Automatic display button

Select to turn automatic display mode on/off. The indicator on the button illuminates during automatic display mode. (→P.211)

#### **C** Front distance guide line (blue)

Shows distance in front of the vehicle.

- Display points approximately 3 ft. (1 m) from the edge of the bumper.

#### **D** Forward projected course lines

Shows an estimated course when the steering wheel is turned.

- This line will be displayed when the steering wheel is turned more than 90° from the center.

### Switching the guide line mode

Each time the guide line switching button is selected, the mode will change as follows:

- ▶ Distance guide line

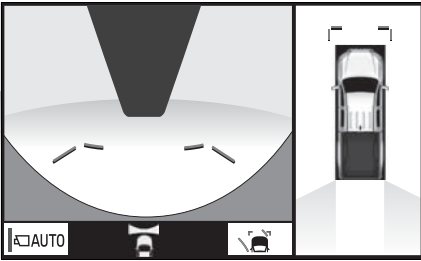

- Only the distance guide lines are displayed.
- ▶ Projected course line

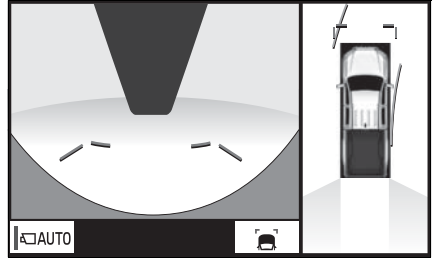

- Projected course lines will be added to the distance guide lines.

### Side views

The image from the both side cameras is displayed and assists the driver to check conditions on the sides of the vehicle or to confirm the safety of narrow roads.

- ▶ Side views

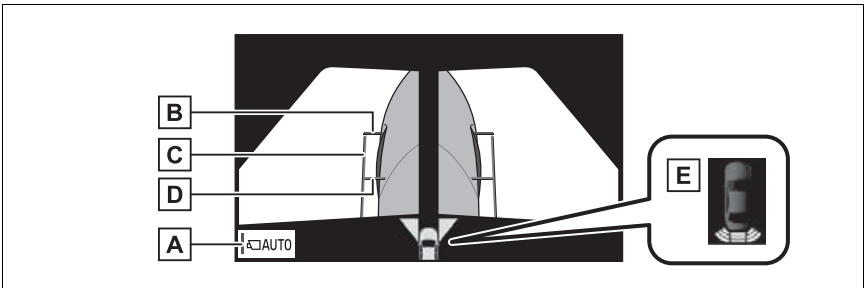

#### A Automatic display button

Select to turn automatic display mode on/off. The indicator on the button illuminates during automatic display mode. (→P.211)

#### B Front distance guide line (red)

Show distance in front of the vehicle.

- Display points approximately 1.6 ft. (0.5 m) from the edge of the bumper.

#### C Vehicle width lines (blue)

Shows guide lines of the vehicle's width including the outside rear view mir-



rors.

#### **D** Front tire contact line (blue)

Shows guide lines of where the front tire touches the ground.

#### **E** Intuitive parking assist\*

When a sensor detects an obstacle, the direction of and the approximate distance to the obstacle are displayed and the buzzer sounds.

\*: If equipped

- Pressing the camera switch changes the screen to the panoramic view & wide front view screen or previously displayed screen, such as the navigation screen.
- For details about the intuitive parking assist, refer to the “OWNER’S MANUAL”.



### WARNING

- When a sensor indicator on the intuitive parking assist display illuminates in red or a buzzer sounds continuously, be sure to check the area around the vehicle immediately and do not proceed any further until safety has been ensured, otherwise an unexpected accident may occur.
- As the intuitive parking assist display is displayed over the camera view, it may be difficult to see the intuitive parking assist display depending on the color and brightness of the surrounding area.

### Using the vehicle width lines

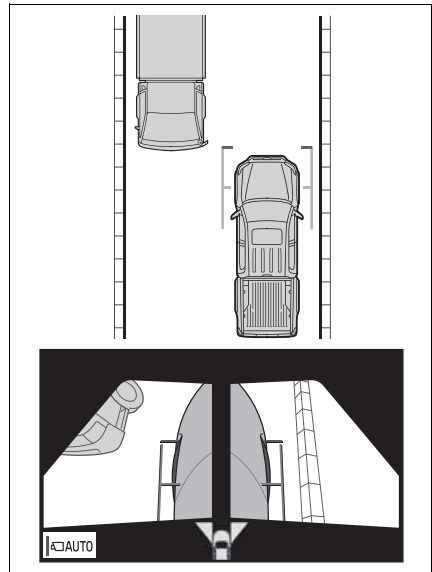

- Check the positions and dis-

tance between the vehicle width line and a target object such as the obstacle or curb of the road.

- Pull over to the curb as shown in the illustration above, taking care not to let the vehicle width line overlap the target object.
- Ensure that the vehicle width line is parallel to the target object.

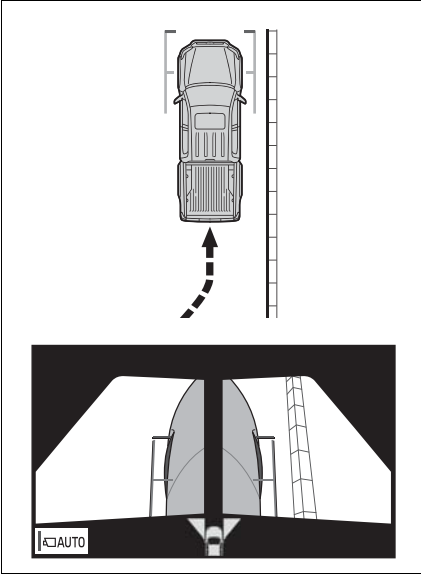

**Panoramic view & rear view/Wide rear view**

The panoramic view & rear view and the wide rear view screen provide support when checking the areas of behind the vehicle and around the vehicle while backing up, for example while parking.

The screens will be displayed when the shift lever is in the “R” position.

▶ Panoramic view & rear view

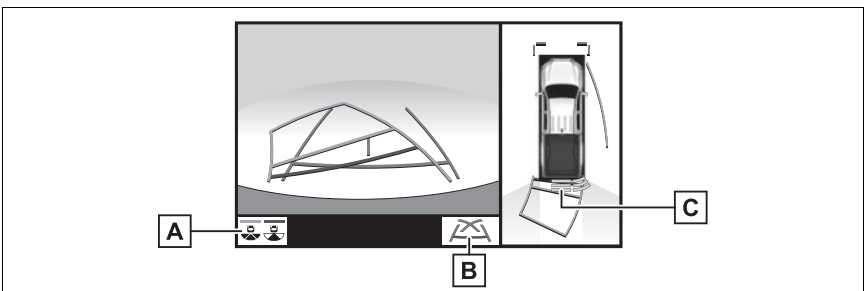

## ▶ Wide rear view

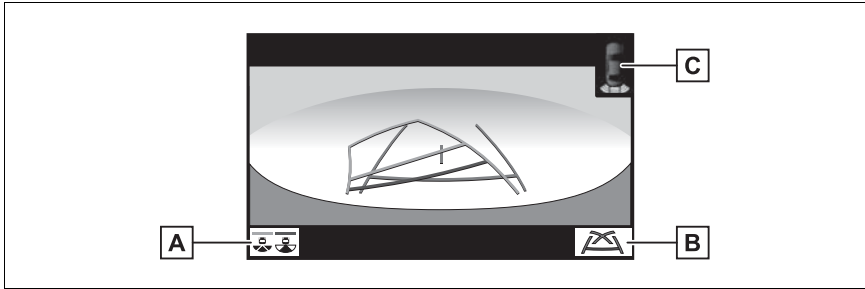
**A** Display mode switching button

Select to switch between panoramic view & rear view display and wide rear view display.

**B** Guide line switching button

Select to switch the guide line mode. (→P.229)

**C** Intuitive parking assist\*

When a sensor detects an obstacle, the direction of and the approximate distance to the obstacle are displayed and the buzzer sounds.

\*: If equipped

- The monitor is cancelled when the shift lever is shifted into any position other than the “R” position.
- For details about the intuitive parking assist, refer to the “OWNER’S MANUAL”.

**WARNING**

- When a sensor indicator on the intuitive parking assist display illuminates in red or a buzzer sounds continuously, be sure to check the area around the vehicle immediately and do not proceed any further until safety has been ensured, otherwise an unexpected accident may occur.
- As the intuitive parking assist display is displayed over the camera view, it may be difficult to see the intuitive parking assist display depending on the color and brightness of the surrounding area.

**Guide lines displayed on the screen**

Each time the guide line switching button is selected, the mode will change as follows:

## ▶ Projected course line

Projected course lines are displayed which move in accordance with

the operation of the steering wheel.

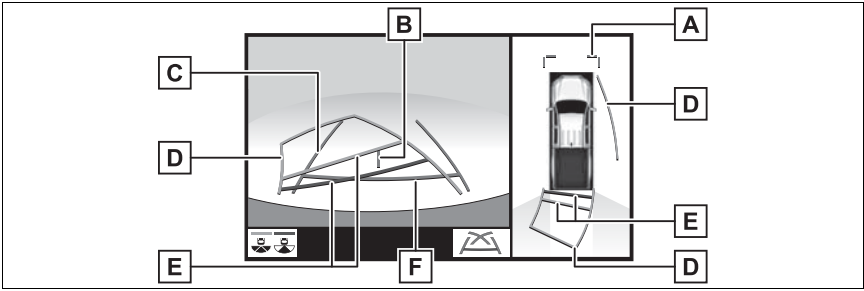

► **Parking assist guide line**

The steering wheel return points (parking assist guide lines) are displayed. This mode is recommended for those who are comfortable with parking the vehicle without the aid of the estimated course lines.

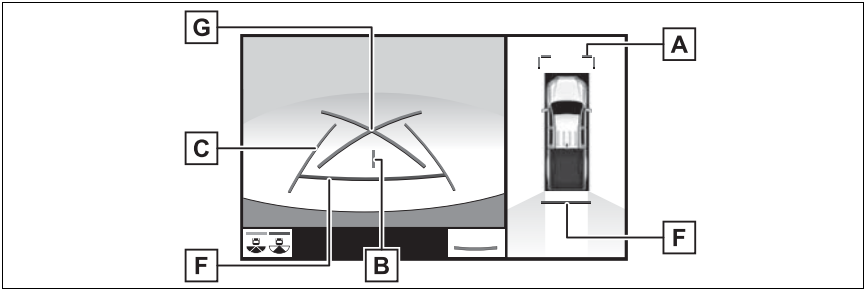

► **Distance guide line**

Only distance guide line is displayed. This mode is recommended for those who are comfortable with parking the vehicle without the aid of the guide lines.

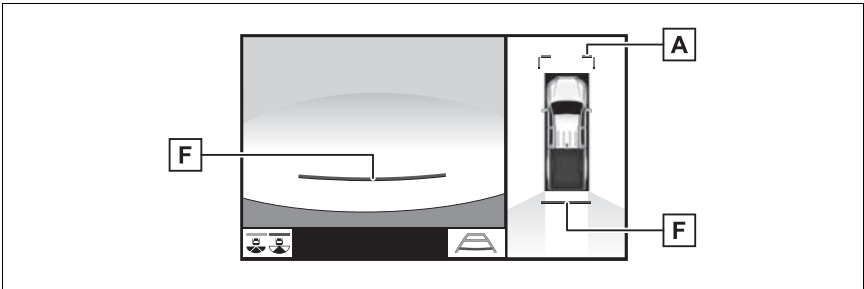

**A** Front distance guide line (blue)

Shows distance in front of the vehicle.

- Display points approximately 3 ft. (1 m) from the edge of the bumper.

**B** Vehicle center line (blue)

The line indicates the estimated vehicle center on the ground.

**C** Rear vehicle width extension guide lines

Displays a guide path when the vehicle is being backed straight up.

**D** Projected reverse course line (yellow)

Shows an estimated course when the steering wheel is turned.

**E** Rear distance guide line

Shows the distance behind the vehicle when the steering wheel is turned.

- The guide lines move in conjunction with the estimated course lines.
- The guide lines display points approximately 1.5 ft. (0.5 m) (red) and approximately 3 ft. (1 m) (yellow) from the center of the edge of the bumper.

**F** Rear distance guide line (blue)

Shows the distance behind the vehicle.

- Displays a point approximately 1.5 ft. (0.5 m) (red/blue) from the edge of the bumper.

**G** Parking assist guide line (blue)

Shows the path of the smallest turn possible behind the vehicle.

**WARNING**

- Depending on the circumstances of the vehicle (number of passengers, amount of luggage, etc.), the position of the guide lines displayed on the screen may change. Be sure to check visually around the vehicle before proceeding.
- If the steering wheel is straight and the vehicle width guide lines and the estimated course lines are not in alignment, have the vehicle inspected by your Toyota dealer.
- Do not use the system if the display is incorrect due to an uneven (hilly) road or a non-straight (curvy) road.

**Parking****Using the projected reverse course line**

When parking in a space which is in the reverse direction to the space described in the proce-

cedure below, the steering directions will be reversed.

- 1 Shift the shift lever to the “R” position.
- 2 Turn the steering wheel so that the estimated course

lines are within the parking space, and back up slowly.

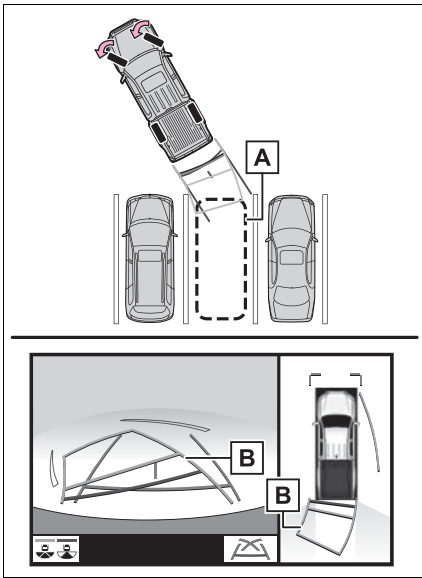

- A** Parking space
  - B** Projected reverse course lines
- 3** When the rear position of the vehicle has entered the parking space, turn the steering wheel so that the vehicle width guide lines are within

the left and right dividing lines of the parking space.

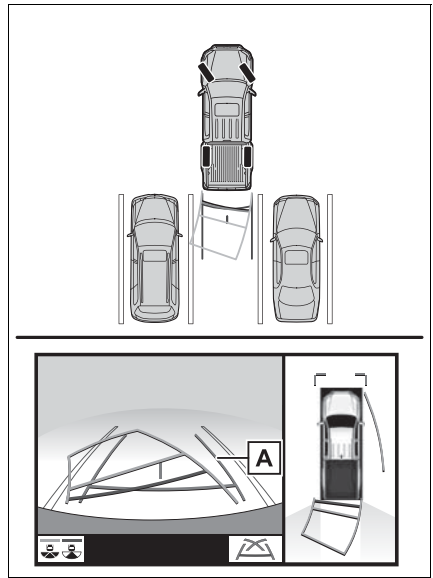

- A** Rear vehicle width extension guide line
- 4** Once the vehicle width guide lines and the parking space lines are parallel, straighten the steering wheel and back up slowly until the vehicle has completely entered the parking space.
- 5** Stop the vehicle in an appropriate place, and finish parking.

**Using parking assist guide line**

When parking in a space which is in the reverse direction to the space described in the procedure below, the steering directions will be reversed.

- 1 Shift the shift lever to the “R” position.
- 2 Back up until the parking assist guide line meets the edge of the left-hand dividing line of the parking space.

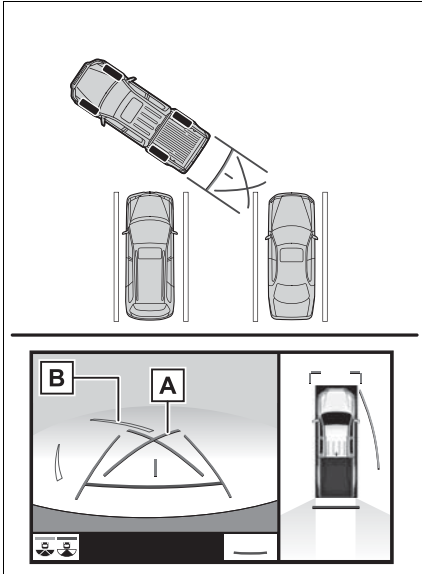

- A** Parking assist guide line
- B** Parking space dividing line
- 3 Turn the steering wheel all the way to the right, and back up slowly.
  - 4 Once the vehicle is parallel with the parking space, straighten the steering wheel and back up slowly until the vehicle has completely entered the parking space.
  - 5 Stop the vehicle in an appropriate place, and finish parking.

## Multi-terrain Monitor precautions

### When using the Multi-terrain Monitor

The Multi-terrain Monitor is a supplemental device intended to assist the driver when checking around the vehicle. When using, be sure to visually check all around the vehicle both directly and using the mirrors before proceeding. If you do not, you may hit another vehicle or possibly cause an accident.

Pay attention to the following precautions when using the Multi-terrain Monitor.

#### **! WARNING**

- Never depend on the Multi-terrain Monitor entirely. The image and the position of the guide lines displayed on the screen may differ from the actual state. Use caution just as you would when driving any other vehicle.
- Always make sure to check all around the vehicle with your own eyes when driving.
- Never drive while looking only at the screen as the image on the screen is different from actual conditions. If you are driving while looking only at the screen, you may hit a person or an object, resulting in an accident. When driving, be sure to check the vehicle's surroundings with your own eyes and the vehicle's mirrors.

**WARNING**

- Depending on the circumstances of the vehicle (number of passengers, amount of luggage, etc.), the position of the guide lines displayed on the screen may change. Be sure to check visually around the vehicle before proceeding.
- Do not use the Multi-terrain Monitor in the following cases:
  - On icy or slick road surfaces, or in snow
  - When using tire chains or emergency tires
  - When the front door or tailgate is not closed completely
  - On roads that are not flat or straight, such as curves or slopes
  - If the suspension has been modified or tires of a size other than specified are installed
- In low temperatures, the screen may darken or the image may become faint. The image could distort when the vehicle is moving, or you may become unable to see the image on the screen. Be sure to visually check all around the vehicle both directly and using the mirrors before proceeding.
- If the tire sizes are changed, the position of the guide lines displayed on the screen may change.
- The camera uses a special lens. The distances between objects and pedestrians that appear in the image displayed on the screen will differ from the actual distances. (→P.239)

**NOTICE**

- In panoramic view, the system combines images taken from the front, back, left and right side cameras into a single image. There are limits to the range and content that can be displayed. Familiarize yourself with the characteristics of the panoramic view monitor system before using it.
- Image clarity may decline at the four corners of the panoramic view. However, this is not a malfunction, as these are the regions along the border of each camera image where the images are combined.
- Depending on lighting conditions near each of the cameras, bright and dark patches may appear on the panoramic view.
- The panoramic view display does not extend higher than the installation position and image capture range of each camera.
- There are blind spots around the vehicle. Accordingly, there are regions not displayed in panoramic view.
- Three-dimensional objects displayed in side view, wide front view or rear view may not be displayed in panoramic view.
- People and other three-dimensional obstacles may appear differently when displayed on the panoramic view. (These differences include, among others, cases in which displayed objects appear to have fallen over, disappear near image processing areas, appear from image processing areas, or when the actual distance to an object differs from the displayed position.)





## NOTICE

- When the tailgate, which is equipped with the back camera, or front doors, which are equipped with door mirrors that have built-in side cameras, are open, images will not be displayed properly on the panoramic view.
- The vehicle icon displayed in panoramic view is a computer generated image. Accordingly, properties such as the color, shape and size will differ from the actual vehicle. For this reason, nearby three-dimensional objects may appear to be touching the vehicle, and actual distances to three-dimensional objects may differ from those displayed.

## Area displayed on screen

### Area of image of panoramic view

Since the panoramic view processes and displays images based on flat road surfaces, it cannot depict the position of three-dimension objects (such as vehicle bumpers, etc.) that are in positions higher than the surface of the road. Even if there is room between the bumpers of the vehicles and it seems not likely to collide in the image, in reality, the both vehicles are on a collision course.

Check the safety of the surroundings directly.

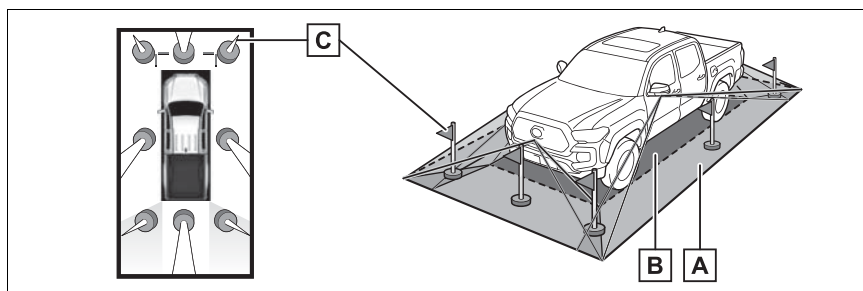

**A** The area displayed on the screen

**B** The area not displayed on the screen

- Objects located in the shaded areas will not be displayed on the screen.

**C** The parts of objects not displayed on the screen

- Parts of objects which extend above a certain height cannot be displayed on the screen.

- As the images obtained from four cameras are processed and displayed on the standard of a flat road surface; the panoramic view may be displayed as follows.
- Objects may look collapsed; thinner or bigger than usual.
- An object with a higher position than the road surface may look farther away than it actually is or may not appear at all.
- Tall objects may appear protruding from the non-displayed areas of the image.
- Variations in the brightness of the image may appear for every camera.
- The displayed image may be shifted by inclination of the vehicle body, change in vehicle height, etc., depending on the number of passengers, amount of luggage, fuel quantity, etc.
- If the front doors or tailgate are not completely closed; neither the image nor the guide lines are displayed.
- The position relations of the vehicle icon and the road surface or obstacle may differ from the actual positions.
- The black areas of the vicinity of the vehicle icon are areas that are not captured by the camera.
- Images like the following are combined, thus some areas may be difficult to view.

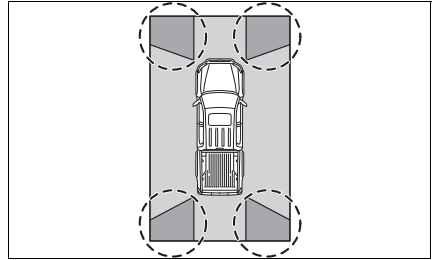

**Area of the image captured by the camera**

► Wide front view

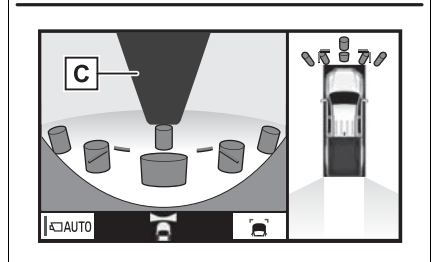
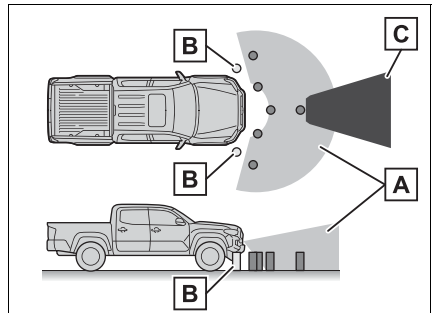

## ▶ Side views

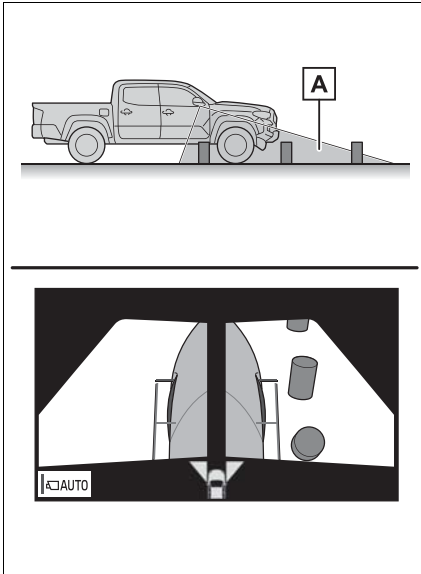

## ▶ Rear view

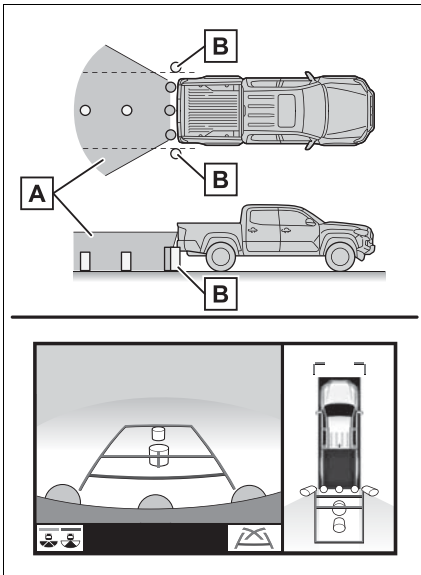

## ▶ Wide rear view

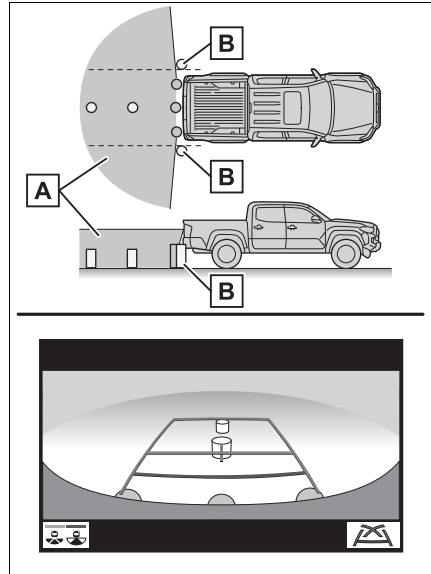

**A** The area displayed on the screen

**B** The objects not displayed on the screen

**C** Black masking

- Black masking is done for distance detection differences to the front of the vehicle.
- The area covered by the camera is limited. Objects which are close to either corner of the bumper or under the bumper cannot be seen on the screen.
- The area displayed on the screen may vary depending on vehicle orientation or road conditions.
- The camera uses a special lens. The distance in the image displayed on the screen will differ from the actual distance.

## The camera

The cameras for the Multi-terrain Monitor are located as shown in the illustration.

### ► Front camera

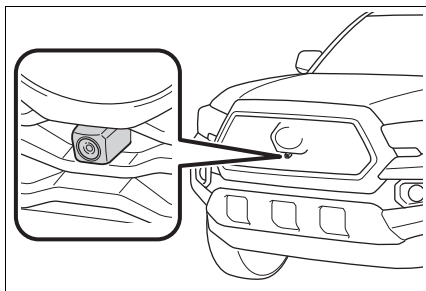

### ► Side cameras

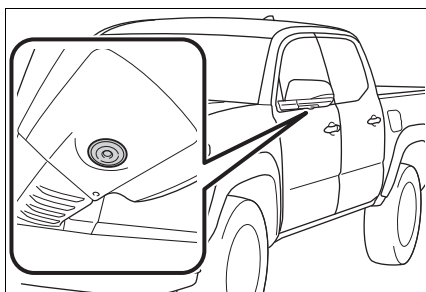

### ► Rear camera

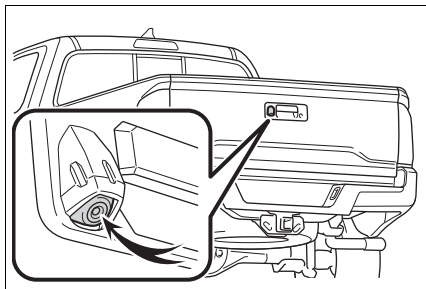

## ■ Using the camera

If dirt or foreign matter (such as water droplets, snow, mud etc.) is adhering to the camera, it cannot transmit a clear image.

In this case, flush it with a large quantity of water and wipe the camera lens clean with a soft and wet cloth.

### ⚠ NOTICE

- The Multi-terrain Monitor may not operate properly in the following cases.
  - If the camera is hit, the position and mounting angle of the camera may change.
  - As the camera has a water proof construction, do not detach, disassemble or modify it. This may cause incorrect operation.
  - When cleaning the camera lens, flush the camera with a large quantity of water and wipe it with a soft and wet cloth. Strongly rubbing the camera lens may cause the camera lens to be scratched and unable to transmit a clear image.
  - Do not allow an organic solvent, car wax, window cleaner or a glass coating to adhere to the camera. If this happens, wipe it off as soon as possible.
  - If the temperature changes rapidly, such as when hot water is poured on the vehicle in cold weather, the system may not operate normally.
  - When washing the vehicle, do not apply intensive bursts of water to the camera or camera area. Doing so may result in the camera malfunctioning.
- Do not expose the camera to strong impacts as this could cause a malfunction. If this happens, have the vehicle inspected by your Toyota dealer as soon as possible.

## Differences between the screen and the actual road

- The distance guide lines and the vehicle width guide lines may not actually be parallel with the dividing lines of the parking space, even when they appear to be so. Be sure to check visually.
- The distances between the vehicle width guide lines and the left and right dividing lines of the parking space may not be equal, even when they appear to be so. Be sure to check visually.
- The distance guide lines give a distance guide for flat road surfaces. In any of the following situations, there is a margin of error between the guide lines on the screen and the actual distance/course on the road.

### ■ When the ground behind the vehicle slopes up sharply

The distance guide lines will appear to be closer to the vehicle than the actual distance. Because of this, objects will appear to be farther away than they actually are. In the same way, there will be a margin of error between the guidelines and the actual distance/course on the road.

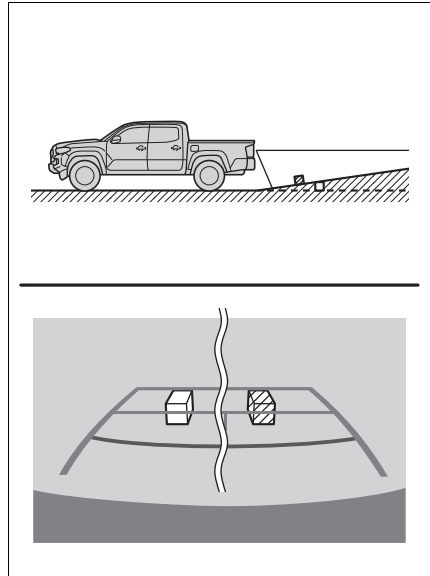

### ■ When the ground behind the vehicle slopes down sharply

The distance guide lines will appear to be farther from the vehicle than the actual distance. Because of this, objects will appear to be closer than they actually are. In the same way, there will be a margin of error between the guidelines and the actual distance/course on the road.

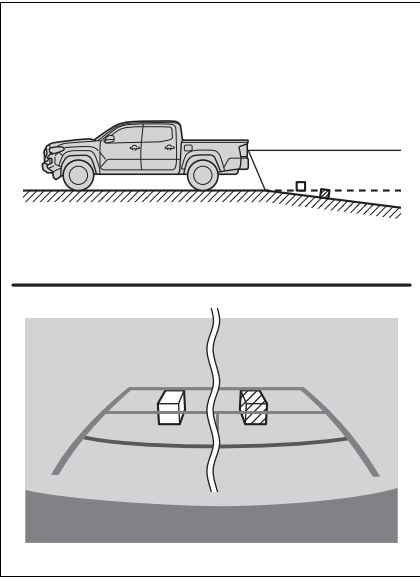

### ■ When any part of the vehicle sags

When any part of the vehicle sags due to the number of passengers or the distribution of the load, there is a margin of error between the guide lines on the screen and the actual distance/course on the road.

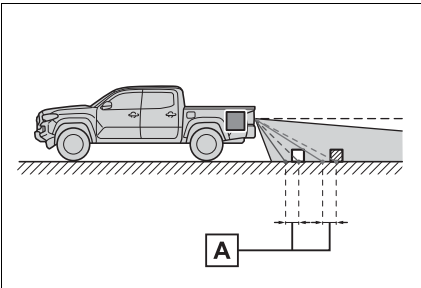

**A** A margin of error

### When approaching three-dimensional objects

When there are three-dimensional objects (such as vehicle bumpers, etc.) nearby in positions higher than the surface of the road, take extra care when using the following.

#### ⚠ WARNING

- When a sensor indicator on the intuitive parking assist display illuminates in red or a buzzer sounds continuously, be sure to check the area around the vehicle immediately and do not proceed any further until safety has been ensured, otherwise an unexpected accident may occur.

### Panoramic view display

Since the panoramic view process and display images based on flat road surfaces, it cannot depict the position of three-dimension objects (such as vehicle bumpers, etc.) that are in positions higher than the surface of the road. For example, even though it appears that there is space between the bumpers of the two vehicles in the illustration below and they are not likely to collide, in reality, a collision is about to occur.

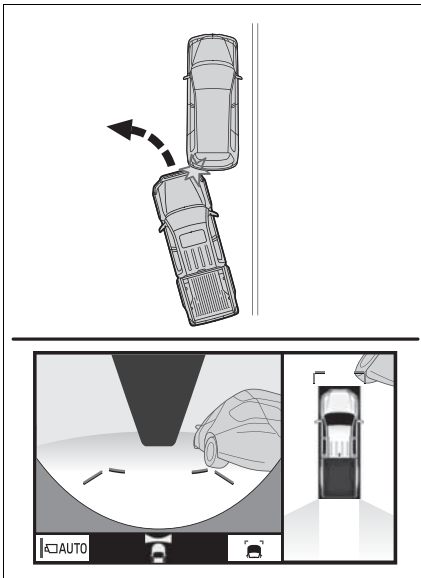

### Projected course lines

- Since the projected course lines is displayed for a flat road surface, it can not depict the position of three-dimensional objects (such as vehicle bumpers, etc.) that are in positions higher than the surface of the road. Even if the bumpers of the vehicle is on the outside of the projected course lines in the image, in reality, the vehicles are on a collision course.

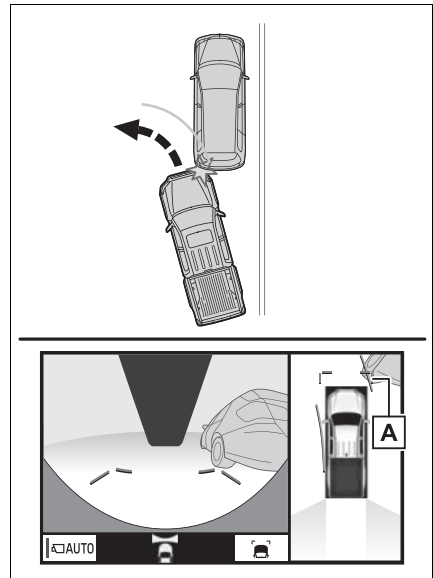

### A Projected course lines

- Three-dimensional objects (such as the overhang of a wall or loading platform of a truck) in high positions may not be projected on the screen. Check the safety of the surroundings directly.

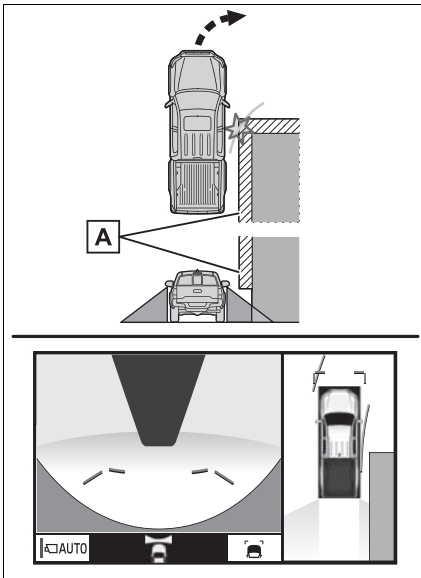

**A** The overhang of a wall

- Visually check the surroundings and the area behind the vehicle. In the case shown below, the truck appears to be outside of the projected course lines and the vehicle does not look as if it hits the truck. However, the rear body of the truck may actually cross over the projected course lines. In reality if you back up as guided by the estimated course lines, the vehicle may hit the truck.

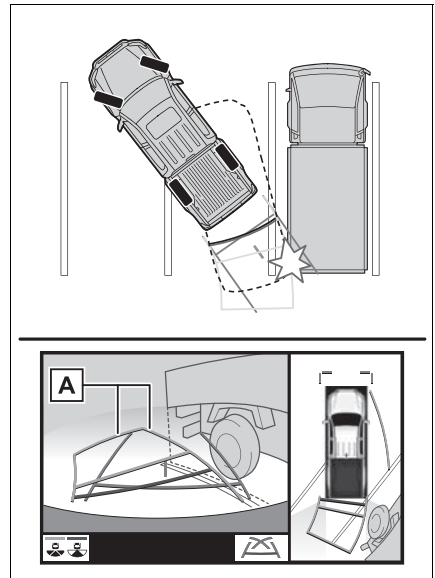

**A** Projected course lines

### Distance guide lines

Visually check the surroundings and the area behind the vehicle. On the screen, it appears that a truck is parking at point **B**. However, in reality if you back up to point **A**, you will hit the truck. On the screen, it appears that **A** is closest and **C** is farthest away. However, in reality, the distance to **A** and **C** is the same, and **B** is farther than **A** and **C**.



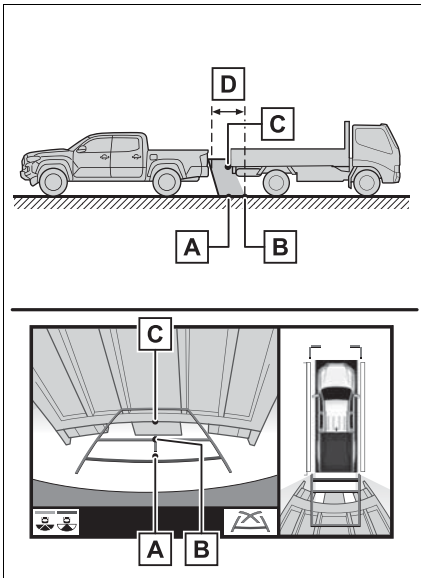

**D** Approx. 3 ft. (1 m)

### Under vehicle terrain view

The images displayed were previously taken approximately 10 ft. (3 m) behind the current vehicle position.

Therefore, actual conditions may differ from those shown on the screen in the following situations.

- An obstacle has appeared after the image was taken
- Loose material like sand or snow has crumbled or shifted
- An obstacle has moved
- There is a puddle, tract of mud, etc., within the display range
- The vehicle slips

In the following situations, actual tire positions and vehicle posi-

tion may differ from those indicated by the tire position indicator lines and vehicle position indicator lines.

- Tires have been replaced
- Optional equipment has been installed

### **!** WARNING

- The displayed guide lines are composed with the image that was previously taken and may differ from the actual state. Always drive the vehicle while confirming the safety of your surroundings.

## Things you should know

### If you notice any symptoms

If you notice any of the following symptoms, refer to the likely cause and the solution, and re-check.

If the symptom is not resolved by the solution, have the vehicle inspected by your Toyota dealer.

Symptom	Likely cause	Solution
The image is difficult to see	<ul style="list-style-type: none"> <li>• The vehicle is in a dark area</li> <li>• The temperature around the lens is either high or low</li> <li>• The outside temperature is low</li> <li>• There are water droplets on the camera</li> <li>• It is raining or humid</li> <li>• Foreign matter (mud etc.) is adhering to the camera</li> <li>• Sunlight or headlights are shining directly into the camera</li> <li>• The vehicle is under fluorescent lights, sodium lights, mercury lights etc.</li> </ul>	<p>Back up while visually checking the vehicle's surroundings. (Use the monitor again once conditions have been improved.)</p> <p>The procedure for adjusting the picture quality of the Multi-terrain Monitor is the same as the procedure for adjusting the navigation screen. (→P.33)</p>
The image is blurry	Dirt or foreign matter (such as water droplets, snow, mud etc.) is adhering to the camera.	Flush the camera with a large quantity of water and wipe the camera lens clean with a soft and wet cloth.
The image is out of alignment	The camera or surrounding area has received a strong impact.	Have the vehicle inspected by your Toyota dealer.

Symptom	Likely cause	Solution
The guide lines are very far out of alignment	The camera position is out of alignment.	Have the vehicle inspected by your Toyota dealer.
	<ul style="list-style-type: none"> <li>• The vehicle is tilted. (There is a heavy load on the vehicle, tire pressure is low due to a tire puncture, etc.)</li> <li>• The vehicle is used on an incline.</li> </ul>	<p>If this happens due to these causes, it does not indicate a malfunction.</p> <p>Back up while visually checking the vehicle's surroundings.</p>
The estimated course lines move even though the steering wheel is straight	There is a malfunction in the signals being output by the steering sensor.	Have the vehicle inspected by your Toyota dealer.
Guide lines are not displayed	The tailgate is open.	Close the tailgate. If this does not resolve the symptom, have the vehicle inspected by your Toyota dealer.
 is displayed	<ul style="list-style-type: none"> <li>• Battery has been reinstalled.</li> <li>• The steering wheel has been moved while the battery was being reinstalled.</li> <li>• Battery power is low.</li> <li>• The steering sensor has been reinstalled.</li> <li>• There is a malfunction in the signals being output by the steering sensor.</li> </ul>	<p>Stop the vehicle, and turn the steering wheel as far as it will go to the left and right.</p> <p>If this does not resolve the symptom, have the vehicle inspected by your Toyota dealer.</p>



### 8-1. Phone operation (Hands-free system for cellular phones)

Quick reference..... 248

Some basics ..... 249

Placing a call using the Bluetooth® hands-free system ..... 253

Receiving a call using the Bluetooth® hands-free system ..... 256

Talking on the Bluetooth® hands-free system..... 257

Bluetooth® phone message function..... 260

### 8-2. Setup

Phone settings ..... 265

### 8-3. What to do if...

Troubleshooting ..... 275

## Quick reference

### Phone screen operation

The phone screen can be reached by the following methods:

- ▶ From the “PHONE” button
  - 1 Press the “PHONE” button.
- ▶ From the “MENU” button
  - 1 Press the “MENU” button, then select “Phone”.



### Bluetooth® hands-free system operation

The following functions can be used on phone operation:

- Registering/connecting a Bluetooth® device (→P.36)
- Placing a call using the Bluetooth® hands-free system (→P.253)
- Receiving a call using the Bluetooth® hands-free system (→P.256)
- Talking on the Bluetooth® hands-free system (→P.257)

### Message function

The following function can be used on message function:

- Using the Bluetooth® phone message function (→P.260)

### Setting up a phone

The following functions can be made in the system:

- Phone settings (→P.265)
- Bluetooth® settings (→P.40)

## Some basics

**The hands-free system enables calls to be made and received without having to take your hands off the steering wheel.**

**This system supports Bluetooth®. Bluetooth® is a wireless data system that enables cellular phones to be used without being connected by a cable or placed in a cradle.**

**The operating procedure of the phone is explained here.**

**When an Apple CarPlay connection is established, phone functions will be performed by Apple CarPlay instead of the hands-free system.**

- This system is not guaranteed to operate with all Bluetooth® devices.
- If your cellular phone does not support Bluetooth®, this system cannot function.
- In the following conditions, the system may not function:
  - The cellular phone is turned off.
  - The current position is outside the communication area.
  - The cellular phone is not connected.
  - The cellular phone has a low battery.
- Depending on the type of Bluetooth® phone, some function is not available.

- When using the hands-free system or Bluetooth® audio and Wi-Fi® hotspot functions at the same time, the following problems may occur:
  - The Bluetooth® connection may be cut.
  - Noise may be heard on the Bluetooth® audio playback.
  - A noise may be heard during phone calls.
- Bluetooth® uses the 2.4 GHz frequency band. If both a Wi-Fi® connection and Bluetooth® connection are being used simultaneously, each connection may be affected.
- If a Bluetooth® device is attempting to connect to the vehicle while another device is connected as a Bluetooth® audio device or connected using the hands-free system or Wi-Fi® hotspot function, the communication speed may decrease or malfunctions may occur, such as image distortion or audio skipping. If a Bluetooth® device is connected to the system, the interference it may cause will be reduced. When carrying a device with its Bluetooth® connection enabled, make sure to register it to the system and connect it or disable its Bluetooth® function.
- When a device is connected via Bluetooth®, the Bluetooth® icon on the status bar will be displayed in blue. (→P.16)

### WARNING

- While driving, do not operate a cellular phone.

**WARNING**

- Your audio unit is fitted with Bluetooth® antennas. People with implantable cardiac pacemakers, cardiac resynchronization therapy-pacemakers or implantable cardioverter defibrillators should maintain a reasonable distance between themselves and the Bluetooth® antennas. The radio waves may affect the operation of such devices.
- Before using Bluetooth® devices, users of any electrical medical device other than implantable cardiac pacemakers, cardiac resynchronization therapy-pacemakers or implantable cardioverter defibrillators should consult the manufacturer of the device for information about its operation under the influence of radio waves. Radio waves could have unexpected effects on the operation of such medical devices.

**NOTICE**

- Do not leave your cellular phone in the vehicle. The temperature inside may rise to a level that could damage the phone.

**Registering/Connecting a Bluetooth® phone**

To use the hands-free system for cellular phones, it is necessary to register a cellular phone with the system. (→P.36)

**■ Connecting a Bluetooth® device**

- ▶ Registering an additional device
    - 1 Display the phone top screen. (→P.248)
    - 2 Select “Select Device”.
    - 3 Select “Add Device”.
  - When another Bluetooth® device is connected, a confirmation screen will be displayed. To disconnect the Bluetooth® device, select “Yes”.
  - 4 Follow the steps in “Registering a Bluetooth® phone for the first time” from step 5. (→P.36)
    - ▶ Selecting a registered device
      - 1 Display the phone top screen. (→P.248)
      - 2 Select “Select Device”.
      - 3 Select the desired device to be connected.
      - 4 Check that a confirmation screen is displayed when the connection is complete.
    - If an error message is displayed, follow the guidance on the screen to try again.
- Bluetooth® phone condition display**

The condition of the Bluetooth® phone appears on the upper right side of the screen. (→P.16)



## Using the phone switch/microphone

### ■ Steering switch

By pressing the phone switch, a call can be received or ended without taking your hands off the steering wheel.

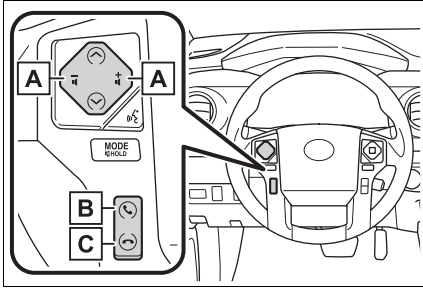

#### A Volume control switch

- Press the “+” side to increase the volume.
- Press the “-” side to decrease the volume.

#### B Off hook switch

- If the switch is pressed when an Apple CarPlay/Android Auto connection is established, the Apple CarPlay/Android Auto phone application will be displayed on the system screen.

#### C On hook switch

### ■ Microphone

The microphone is used when talking on the phone.

#### ► Type A

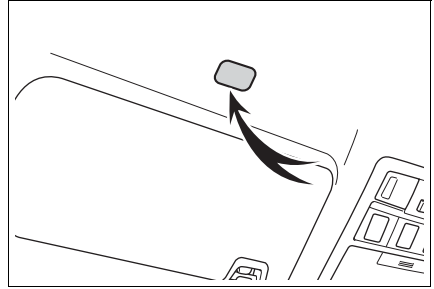

#### ► Type B

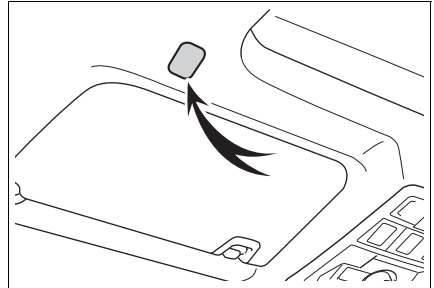

- The other party's voice will be heard from the front speakers. The audio/visual system will be muted during phone calls or when hands-free voice commands are used.
- Talk alternately with the other party on the phone. If both parties speak at the same time, the other party may not hear what has been said. (This is not a malfunction.)
- Keep call volume down. Otherwise, the other party's voice may be audible outside the vehicle and voice echo may increase. When talking on the phone, speak clearly towards the microphone.
- The other party may not hear you clearly when:
  - Driving on an unpaved road. (Making excessive traffic noise.)
  - Driving at high speeds.
  - The roof or windows are open.
  - The air conditioning vents are pointed towards the microphone.

- The sound of the air conditioning fan is loud.
- There is a negative effect on sound quality due to the phone and/or network being used.

**NOTICE**

- Do not touch and put a sharp object to the microphone. It may cause failure.

**Voice command system**

Press this switch to operate the voice command system.

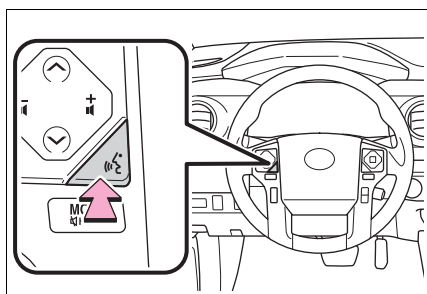

- The voice command system and its list of commands can be operated. (→P.158)

**About the contacts in the contact list**

- The following data is stored for every registered phone. When another phone is connected, the following registered data cannot be read:
  - Contact data
  - Call history data
  - Favorites data
  - Image data
  - All phone settings

- Message settings

- When a phone's registration is deleted, the above-mentioned data is also deleted.

**When selling or disposing of the vehicle**

A lot of personal data is registered when the hands-free system is used. When selling or disposing of the vehicle, initialize the data. (→P.63)

- The following data in the system can be initialized:
  - Contact data
  - Call history data
  - Favorites data
  - Image data
  - All phone settings
  - Message settings
- Once initialized, the data and settings will be erased. Pay additional attention when initializing the data.

## Placing a call using the Bluetooth® hands-free system

After a Bluetooth® phone has been registered, a call can be made using the hands-free system. There are several methods by which a call can be made, as described below.

### Calling methods on the Bluetooth® phone

- 1 Display the phone top screen. (→P.248)
- 2 Select the desired method to call from.



### ■ Calling methods from phone screen

- By call history (→P.253)
- By favorites (→P.254)
- By contacts (→P.254)
- By keypad (→P.255)
- By message (→P.263)

■ Also the following lists are available from each function's screen

- By POI call\* (→P.79)
- By voice command system (→P.159)
- By home screen (→P.256)

\*: Premium Audio only

### By call history

Up to 30 of the latest call history items (missed, incoming and outgoing) can be selected.

- 1 Display the phone top screen. (→P.248)
- 2 Select "History" and select the desired contact.
  - If the contact which is not registered on the contact list is selected, the name is displayed as "Unknown Contact". In this case, select the number to make a call properly.
- 3 Check that the dialing screen is displayed.

● The icons of call type are displayed.

 : Missed call

 : Incoming call

 : Outgoing call

● When making a call to the same number continuously, only the most recent call is listed in call history.

- When a phone number registered in the contact list is received, the name is displayed.
- Number-withheld calls are also memorized in the system.
- International phone calls may not be made depending on the type of Bluetooth® phone you have.
- The list should group together consecutive entries with the same phone number and same call type. For example, two calls from John's mobile would be displayed as follows: John (2)

### By favorites list

Calls can be made using registered contacts which can be selected from a contact list.

(→P.254)

- 1 Display the phone top screen. (→P.248)
- 2 Select "Favorites" and select the desired contact.
- 3 Select the desired number.
- 4 Check that the dialing screen is displayed.

### By contacts list

Calls can be made by using contact data which is transferred from a registered cellular phone.

(→P.267)

Up to 5000 contacts (maximum of 4 phone numbers, e-mail addresses and addresses per contact) can be registered in the contact list.

- 1 Display the phone top screen. (→P.248)
- 2 Select "Contacts" and select the desired contact.
- 3 Select the desired number.

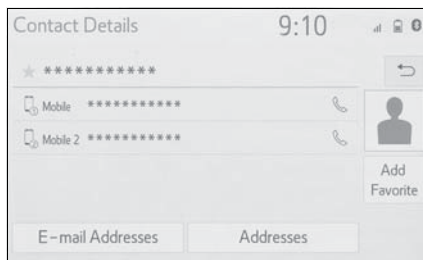

"Add Favorite"/"Remove Favorite": Select to register/remove the contact in the favorites list. (→P.272)

"E-mail Addresses": Select to display all registered e-mail addresses for the contact.

"Addresses": Select to display all registered addresses for the contact.

- 4 Check that the dialing screen is displayed.

### When the contact list is empty

- For PBAP compatible Bluetooth® phones when "Automatic Transfer" is set to on (→P.267)
- Contacts are transferred automatically.

■ **For PBAP compatible Bluetooth® phones when “Automatic Transfer” is set to off (→P.267)**

1 Select the desired item.

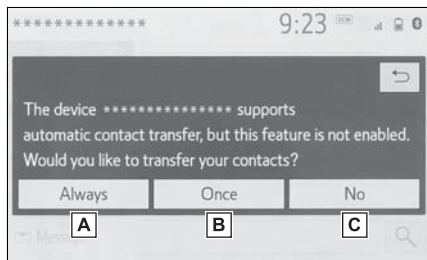

**A** Select to always transfer all the contacts from a connected cellular phone automatically.

**B** Select to transfer all the contacts from a connected cellular phone only once.

**C** Select to cancel transferring.

2 Check that a confirmation screen is displayed when the operation is complete.

■ **For PBAP incompatible but OPP compatible Bluetooth® phones**

1 Select the desired item.

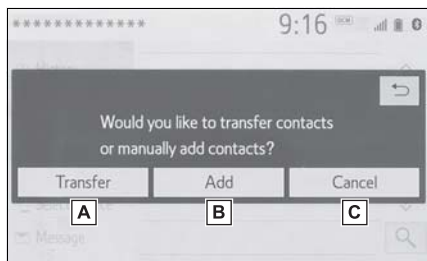

**A** Select to transfer the con-

tacts from the connected cellular phone.

Transfer the contact data to the system using a Bluetooth® phone.

**B** Select to add a new contact manually.

Follow the steps in “Registering a new contact to the contacts list” from step 2. (→P.270)

**C** Select to cancel transferring.

● If your cellular phone is neither PBAP nor OPP compatible, the contacts cannot be transferred using Bluetooth®. But the contacts can be transferred from USB device. (→P.270)



● Depending on the type of Bluetooth® phone:

- It may be necessary to perform additional steps on the phone when transferring contact data.
- The registered image in the contact list may not transfer depending on the type of Bluetooth® phone connected.

### By keypad

1 Display the phone top screen. (→P.248)

2 Select “Keypad” and enter the phone number.

3 Select  or press the  switch on the steering wheel.

4 Check that the dialing screen is displayed.

● Depending on the type of Blue-

tooth<sup>®</sup> phone being connected, it may be necessary to perform additional steps on the phone.

### By home screen

- 1 Display the home screen.  
(→P.29)
- 2 Select the desired contact.
- 3 Check that the dialing screen is displayed.

### ■ Registering a new contact

- 1 Select and hold the screen button to add a contact.
- 2 Select the desired contact.
- 3 Select the desired number.

- If there is no contact in the contacts list, the contacts cannot be registered at the home screen.
- The contact cannot be registered at the home screen while driving.

## Receiving a call using the Bluetooth<sup>®</sup> hands-free system

When a call is received, the following screen is displayed with a sound.

### Incoming calls

- 1 Select “Answer” or press the  switch on the steering wheel to talk on the phone.

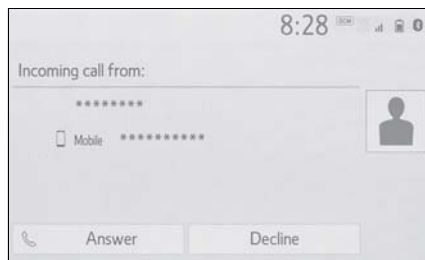

“Decline”: Select to refuse to receive the call.

To adjust the volume of a received call: Turn the “POWER VOLUME” knob, or use the volume control switch on the steering wheel.

- The contact image picture can be displayed only when the vehicle is not moving.
- During international phone calls, the other party’s name or number may not be displayed correctly depending on the type of Bluetooth<sup>®</sup> phone you have.
- The incoming call display mode can be set. (→P.266)
- The ringtone that has been set in the sound settings screen can be heard when there is an incoming

call. Depending on the type of Bluetooth® phone, both the system and Bluetooth® phone may ring simultaneously when there is an incoming call. (→P.265)

## Talking on the Bluetooth® hands-free system

While talking on the phone, the following screen is displayed. The operations outlined below can be performed on this screen.

### Call screen operation

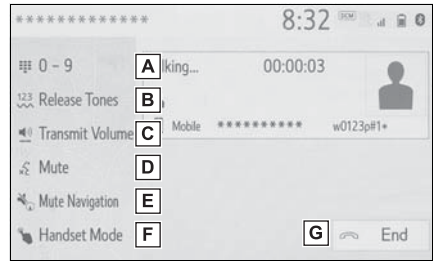

- A** Select to display the keypad to send tones. (→P.258)
- B** Select to send tones. This button only appears when a number that contains a (w) is dialed in hands-free mode. (→P.258)
- C** Select to adjust your voice volume that the other party hears from their speaker. (→P.258)
- D** Select to mute your voice to the other party.
- E** Select to mute the navigation route guidance during a phone call.\*
- F** Select to change handset

modes between hands-free and cellular phone.

**G** Select to hang up the phone.

\* : Premium Audio only

- Changing from hands-free call to cellular phone call is not possible while driving.
- Only when the vehicle is not moving, the contact image can be displayed.
- When cellular phone call is changed to hands-free call, the hands-free screen will be displayed and its functions can be operated on the screen.
- Changing between cellular phone call and hands-free call can be performed by operating the cellular phone directly.
- Transferring methods and operations will be different depending on the type of cellular phone you have.
- For the operation of the cellular phone, see the manual that comes with it.

## Sending tones

### ■ By keypad

This operation cannot be performed while driving.

- 1 Select "0-9".
- 2 Enter the desired number.

### ■ By selecting "Release Tones"

"Release Tones" appear when a continuous tone signal(s) containing a (w) is registered in the contact list.

This operation can be per-

formed while driving.

- 1 Select "Release Tones".

- A continuous tone signal is a character string that consists of numbers and the characters "p" or "w". (e.g. 056133w0123p#1)
- When the "p" pause tone is used, the tone data up until the next pause tone will be automatically sent after 2 seconds have elapsed. When the "w" pause tone is used, the tone data up until the next pause tone will be automatically sent after a user operation is performed.
- Release tones can be used when automated operation of a phone based service such as an answering machine or bank phone service is desired. A phone number with continuous tone signals can be registered in the contact list.
- Tone data after a "w" pause tone can be operated by voice command during a call.

## Transmit volume setting

- 1 Select "Transmit Volume".
- 2 Select the desired level for the transmit volume.
- 3 Select  to display previous screen.

- The sound quality of the voice heard from the other party's speaker may be negatively impacted.
- "Transmit Volume" is dimmed when mute is on.



## Switching calls while a call is in progress

- When there are no calls on hold during a call: “Hold” is displayed. When selected, the current call is placed on hold.
- When there is no current call, but there is a call on hold: “Activate” is displayed. When selected, the system switches to the call that was on hold.
- When there is another call on hold during a call: “Swap Calls” is displayed. When selected, the current call is placed on hold, and the system switches to the call that was on hold.

- 
- This function may not be available depending on the type of cellular phone.

## Incoming call waiting

When a call is interrupted by a third party while talking, the incoming screen is displayed.

- 1 Select “Answer” or press the  switch on the steering wheel to start talking with the other party.
- To refuse to receive the call: Select “Decline”.
  - Each time “Swap Calls” is selected, the party who is on hold will be switched.

- 
- This function may not be available depending on the type of Bluetooth® phone.

## Bluetooth® phone message function

Received messages can be forwarded from the connected Bluetooth® phone, enabling checking and replying using the system.

Depending on the type of Bluetooth® phone connected, received messages may not be transferred to the system.

If the phone does not support the message function, this function cannot be used. Even when the supported phone is used, reply function may not be used.

## Displaying the message screen

- 1 Display the phone top screen. (→P.248)
  - 2 Select “Message”.
    - A confirmation message appears when the “Automatic Message Transfer” function is set to off (→P.273), select “Yes”.
  - 3 Check that the message screen is displayed.
- “Phone”: Select to change to phone mode.
- The account name is displayed on the left side of

screen.

- Account names are the names of the accounts that exist on the currently connected phone.
- The following functions can be used on message function:
  - Receiving a message (→P.260)
  - Checking messages (→P.261)
  - Replying to a message (dictation reply) (→P.262)
  - Replying to a message (quick reply) (→P.262)
  - Calling the message sender (→P.263)
  - Message settings (→P.273)

## Receiving a message

When an e-mail/SMS/MMS is received, the incoming message screen pops up with sound and is ready to be operated on the screen.

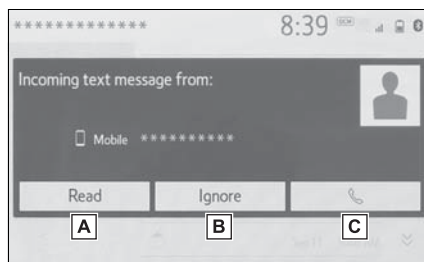

- A** Select to check the message.
- B** Select to not open the message.
- C** Select to call the message

sender.

- Depending on the type of Bluetooth® phone used for receiving messages, or its registration status with the system, some information may not be displayed.
- The pop-up screen is separately available for incoming e-mail and SMS/MMS messages under the following conditions:

E-mail:

- “Incoming E-mail Display” is set to “Full Screen”. (→P.266)
- “E-mail Notification Pop-up” is set to on. (→P.266)

SMS/MMS:

- “Incoming SMS/MMS Display” is set to “Full Screen”. (→P.266)
- “SMS/MMS Notification Pop-up” is set to on. (→P.266)
- Depending on the type of Bluetooth® phone being connected, E-Mail function cannot be used via Bluetooth®.

## Checking received messages

- 1 Display the message screen. (→P.260)
- 2 Select a desired account name.
- 3 Select the desired message from the list.

- 4 Check that the message is displayed.

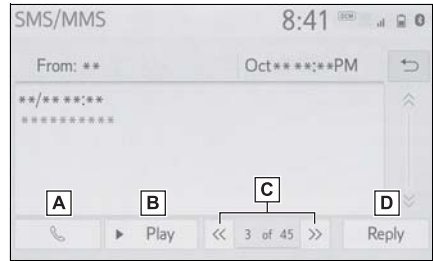

- A Select to call the message sender.
- B Select to have messages read out.  
To cancel this function, select “Stop”.  
When “Automatic Message Readout” is set to on, messages will be automatically read out. (→P.273)
- C Select to display the previous or next message.
- D This function can be chosen the method to reply message with “Dictation” or “Quick Message”.

- Reading a text message is not available while driving.
- Depending on the type of Bluetooth® phone being connected, this function cannot be used.
- Depending on the type of Bluetooth® phone being connected, it may be necessary to perform additional steps on the phone.
- Messages are displayed in the appropriate connected Bluetooth® phone’s registered mail address folder. Select the desired

folder to be displayed.

- Only received messages on the connected Bluetooth® phone can be displayed.
- The text of the message is not displayed while driving.
- Turn the “POWER VOLUME” knob, or use the volume control switch on the steering wheel to adjust the message read out volume.
- “Subject:” field is not shown on SMS case.
- E-mail only: Select “Mark Unread” or “Mark Read” to mark mail unread or read on the message screen.  
This function is available when “Update Message Read Status on Phone” is set to on. (→P.273)

### Replying to a message (dictation reply)\*

\*: If equipped

- 1 Display the message screen. (→P.260)
- 2 Select the desired message from the list.
- 3 Select “Reply”.
- 4 Select “Dictation”.
- 5 When the “Say Your Message” screen is displayed, speak message that you want to send.
- 6 Select “Send” to send message.

“Cancel”: Select to cancel sending the message.

“Retry”: Select to retry speaking message that you want to send.

- While the message is being

sent, a sending message screen is displayed.

- 7 Check that a confirmation screen is displayed when the operation is complete.
- If an error message is displayed, follow the guidance on the screen to try again.

### Replying to a message (quick reply)

15 messages have already been stored.

- 1 Display the message screen. (→P.260)
- 2 Select the desired message from the list.
- 3 Select “Reply”.
- 4 Select “Quick Message”.
- 5 Select the desired message.

: Select to edit the message. (→P.263)

- 6 Select “Send”.

“Cancel”: Select to cancel sending the message.

- While the message is being sent, a sending message screen is displayed.
- 7 Check that a confirmation screen is displayed when the operation is complete.

- If an error message is displayed, follow the guidance on the screen to try again.

- 
- Depending on the type of Blue-

tooth<sup>®</sup> phone, reply function is not available.

### ■ Editing quick reply messages

This operation cannot be performed while driving.

- 1 Select  corresponding to the desired message to edit.
- 2 Select "OK" when editing is completed.

- 
- To reset the edited quick reply messages, select "Default".
  - Quick message 1 ("I am driving and will arrive in approximately [##] minutes.")\*:  
This message cannot be edited and will automatically fill in [##] with the navigation calculated estimated time of arrival on the confirm message screen.  
If there are waypoints set, [##] to the next waypoint will be shown.  
If there is no route currently set in the navigation system, quick message 1 cannot be selected.



\*: Premium Audio only

### Calling the message sender

Calls can be made to an e-mail/SMS/MMS message sender's phone number.

This operation can be performed while driving.

### ■ Calling from e-mail/SMS/MMS message display

- 1 Display the message screen. (→P.260)
- 2 Select the desired message.
- 3 Select , or press the  switch on the steering wheel.
- If there are 2 or more phone numbers, select the desired number.
- 4 Check that the dialing screen is displayed.

### ■ Calling from a number within a message

Calls can be made to a number identified in a message's text area.

This operation cannot be performed while driving.

- 1 Display the message screen. (→P.260)
- 2 Select the desired message.
- 3 Select the text area.



- Identified phone numbers contained in the message are displayed in blue text.
- 4 Select the desired number.

- 5 Check that the dialing screen is displayed.

---

- A series of numbers may be recognized as a phone number. Additionally, some phone numbers may not be recognized, such as those for other countries.

#### ■ Calling from the incoming message screen

For detail, refer to “Receiving a message”. (→P.260)

## Phone settings

### Displaying the phone settings screen

- 1 Press the "MENU" button.

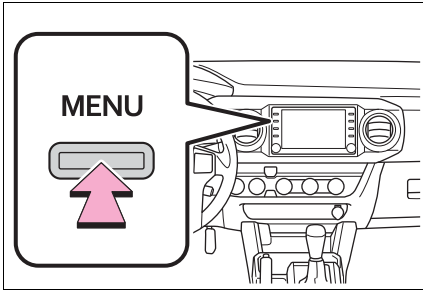

- 2 Select "Setup".
- 3 Select "Phone".
- 4 Select the desired item to be set.

### Phone settings screen

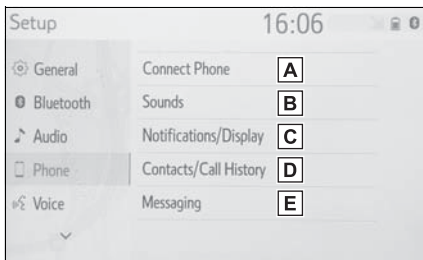

- A** Connecting a Bluetooth® device and editing the Bluetooth® device information (→P.41, 43)
- B** Sound settings\* (→P.265)
- C** Notifications/display settings\* (→P.266)
- D** Contact/call history settings\*

(→P.267)

- E** Message settings\* (→P.273)

\*: This operation cannot be performed while driving.

### Sounds settings screen

The call and ringtone volume can be adjusted. A ringtone can be selected.

- 1 Display the phone settings screen. (→P.265)
- 2 Select "Sounds".
- 3 Select the desired item to be set.



- A** Select to set the desired ringtone.
- B** Select "-" or "+" to adjust the ringtone volume.
- C** Select "-" or "+" to adjust the default volume of the other party's voice.

- D** Select to set the desired incoming e-mail tone.
- E** Select to set the desired incoming SMS/MMS tone.
- F** Select “-” or “+” to adjust the incoming SMS/MMS tone volume.
- G** Select “-” or “+” to adjust the incoming e-mail tone volume.
- H** Select “-” or “+” to adjust the message readout volume.
- I** Select to reset all setup items.

● Depending on the type of Bluetooth® phone, certain functions may not be available.

### Notifications/display settings screen

- 1 Display the phone settings screen. (→P.265)
- 2 Select “Notifications/Display”.

- 3 Select the desired item to be set.

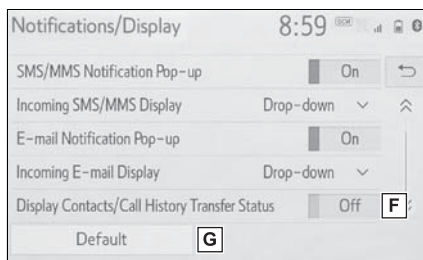
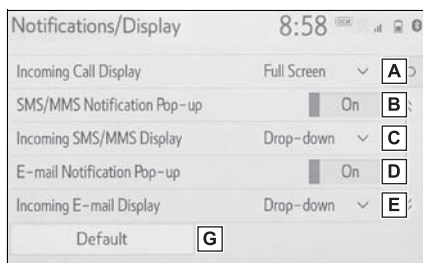

- A** Select to change the incoming call display.

“Full Screen”: When a call is received, the incoming call screen is displayed and can be operated on the screen.

“Drop-down”: A message is displayed at the top of the screen.

- B** Select to set the SMS/MMS notification pop-up on/off.

- C** Select to change the incoming SMS/MMS display.

“Full Screen”: When an SMS/MMS message is received, the incoming SMS/MMS display screen is displayed and can be operated on the screen.

“Drop-down”: When an SMS/MMS message is received, a message is displayed at the top of the screen.

- D** Select to set the e-mail notification pop-up on/off.



- E** Select to change the incoming e-mail display.

“Full Screen”: When an e-mail is received, the incoming e-mail display screen is displayed and can be operated on the screen.

“Drop-down”: When an e-mail is received, a message is displayed at the top of the screen.

- F** Select to set display of the contact/history transfer completion message on/off.
- G** Select to reset all setup items.

- Depending on the type of Bluetooth® phone, these functions may not be available.

### Contacts/Call history settings screen

Contacts can be transferred from a Bluetooth® phone to this system. Contacts and favorites can be added, edited and deleted. Also, the call history can be deleted.

- 1 Display the phone settings screen. (→P.265)
- 2 Select “Contacts/Call History”.

- 3 Select the desired item to be set.

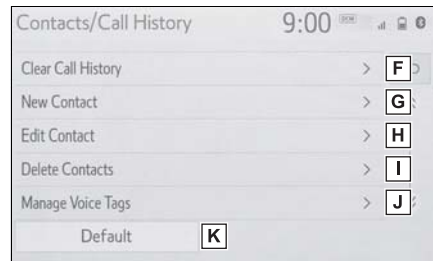
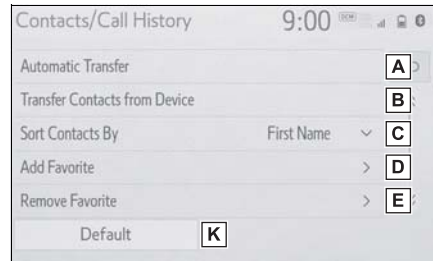

- A** For PBAP compatible Bluetooth® phones: Select to change the contact/history transfer settings. (→P.268)
- B** Select to update contacts from the connected device. (→P.269)
- C** Select to sort contacts by the first name or last name field.
- D** Select to add contacts to the favorites list. (→P.271)
- E** Select to delete contacts from the favorites list. (→P.272)
- F** Select to clear the call history.\*
- G** Select to add new contacts to the contact list.\* (→P.270)

- H** Select to edit contacts in the contact list. \* (→P.271)
- I** Select to delete contacts from the contact list. \* (→P.271)
- J** Select to set the voice tags. (→P.272)
- K** Select to reset all setup items.

\*: For PBAP compatible Bluetooth® phones, this function is available when “Automatic Transfer” is set to off. (→P.268)

- Depending on the type of Bluetooth® phone, certain functions may not be available.
- Contact data is managed independently for every registered phone. When one phone is connected, another phone’s registered data cannot be read.

### Setting automatic contact/history transfer

The automatic contact/history function is available for PBAP compatible Bluetooth® phones only.

- 1 Select “Automatic Transfer”.

- 2 Select the desired item to be set.



- A** Select to set automatic contact/history transfer on/off. When set to on, the phone’s contact data and history are automatically transferred.
- B** Select to update contacts from the connected phone. (→P.268)
- C** Select to set the transferred contact image display on/off. Only when the vehicle is not moving, the contact image can be displayed.
- D** Select to reset all setup items.

### ■ Updating contacts from phone

- 1 Select “Update Now”.
- Contacts are transferred automatically.
- 2 Check that a confirmation screen is displayed when the operation is complete.
- This operation may be unnecessary depending on the type of Bluetooth® phone.

- If another Bluetooth® device is connected when transferring contact data, depending on the phone, the connected Bluetooth® device may need to be disconnected.
- Depending on the type of Bluetooth® phone being connected, it may be necessary to perform additional steps on the phone.

#### ■ **Updating the contacts in a different way (from the call history screen)\***

- 1 Display the phone top screen. (→P.248)
- 2 Select “History” and select a contact not yet registered in the contact list.
- 3 Select “Update Contact”.
- 4 Select the desired contact.
- 5 Select a phone type for the phone number.

\*: For PBAP compatible Bluetooth® phones, this function is available when “Automatic Transfer” is set to off. (→P.268)

#### **Transfer contacts from device**

- When an Android Auto connection is established, this function will be unavailable.

#### **From phone (OPP compatible Bluetooth® phones only)**

- ▶ When the contact is not registered
    - 1 Select “Transfer Contacts from Device”.
    - 2 Select “From Phone (Bluetooth)”.
    - 3 Transfer the contact data to the system using a Bluetooth® phone.
  - This operation may be unnecessary depending on the type of Bluetooth® phone.
  - To cancel this function, select “Cancel”.
  - 4 Check that a confirmation screen is displayed when the operation is complete.
  - ▶ When the contact is registered
    - 1 Select “Transfer Contacts from Device”.
    - 2 Select “From Phone (Bluetooth)”.
    - 3 Select “Replace Contacts” or “Add Contact”.
- “Replace Contacts”: Select to transfer the contact from the connected cellular phone and replace the current one.
- “Add Contact”: Select to transfer the desired contact data from the connected cellular phone to add to the current one.

- 4 Transfer the contact data to the system using a Bluetooth® phone.
  - This operation may be unnecessary depending on the type of Bluetooth® phone.
  - To cancel this function, select “Cancel”.
- 5 Check that a confirmation screen is displayed when the operation is complete.

### From USB device

Backed-up contact data (“vCard” formatted) can be transferred from USB device or Bluetooth® phone to this system.

- 1 Connect a USB device. (→P.122)
- 2 Select “Transfer Contacts from Device”.
- 3 Select “From USB”.
- 4 Select “USB 1” or “USB 2” when the multiple USB devices are connected. If a USB device is connected, skip this procedure.
- 5 Select “Replace Contacts” or “Add Contact”. If the contact is already registered, skip this procedure.

“Replace Contacts”: Select to transfer the contact from the connected USB device or Bluetooth® phone and replace the current one.

“Add Contact”: Select to transfer

the desired contact data from the connected USB device or Bluetooth® phone to add to the current one.

- 6 Select a desired file from vCard file list.
- 7 Check that a confirmation screen is displayed when the operation is complete.

- 
- Depending on the type of Bluetooth® phone used and number of files, it may take time to display vCard file lists and download contacts.
  - Downloading may not complete correctly in the following cases:
    - If the engine switch is turned off during downloading.
    - If the USB device or Bluetooth® phone is removed before downloading is complete.

### Registering a new contact to the contacts list

New contact data can be registered.

Up to 4 numbers per person can be registered. For PBAP compatible Bluetooth® phones, this function is available when “Automatic Transfer” is set to off.

(→P.267)

- 1 Select “New Contact”.
- 2 Enter the name and select “OK”.
- 3 Enter the phone number and select “OK”.
- 4 Select the phone type for the phone number.

5 To add another number to this contact, select “Yes”.

### ■ Registering a new contact in a different way (from the call history screen)

- 1 Display the phone top screen. (→P.248)
- 2 Select “History” and select a contact not yet registered in the contact list.
- 3 Select “Add to Contacts”.
- 4 Follow the steps in “Registering a new contact to the contacts list” from step 2. (→P.270)

### Editing the contact data

For PBAP compatible Bluetooth® phones, this function is available when “Automatic Transfer” is set to off. (→P.267)

- 1 Select “Edit Contact”.
- 2 Select the desired contact.
- 3 Select  next to the name or desired number.
- 4 Enter the name or the phone number and select “OK”.

### Deleting the contact data

For PBAP compatible Bluetooth® phones, this function is available when “Automatic Transfer” is set to off. (→P.267)

- 1 Select “Delete Contacts”.

- 2 Select the desired contact and select “Delete”.
- 3 Select “Yes” when the confirmation screen appears.

- Multiple data can be selected and deleted at the same time.
- When a Bluetooth® phone is deleted, the contact data will be deleted at the same time.

### Favorites list setting

Up to 15 contacts (maximum of 4 numbers per contact) can be registered in the favorites list.

### ■ Registering the contacts in the favorites list

- 1 Select “Add Favorite”.
- 2 Select the desired contact to add to the favorites list.
- Dimmed contacts are already stored as a favorite.
- 3 Check that a confirmation screen is displayed when the operation is complete.
- ▶ When 15 contacts have already been registered to the favorites list
- 1 When 15 contacts have already been registered to the favorites list, a registered contact needs to be replaced. Select “Yes” when the confirmation screen appears to replace a contact.
- 2 Select the contact to be replaced.

- 3 Check that a confirmation screen is displayed when the operation is complete.

### ■ Registering contacts in the favorites list in a different way (from the contact details screen)

- 1 Display the phone top screen. (→P.248)
- 2 Select “Contacts” and select the desired contact.
- 3 Select “Add Favorite”.
- 4 Check that a confirmation screen is displayed when the operation is complete.

### ■ Deleting the contacts in the favorites list

- 1 Select “Remove Favorite”.
- 2 Select the desired contacts and select “Remove”.
- 3 Select “Yes” when the confirmation screen appears.
- 4 Check that a confirmation screen is displayed when the operation is complete.

### ■ Deleting contacts in the favorites list in a different way (from the contact details screen)

- 1 Display the phone top screen. (→P.248)
- 2 Select “Favorites” or “Contacts” and select the desired contact to delete.
- 3 Select “Remove Favorite”.

- 4 Select “Yes” when the confirmation screen appears.
- 5 Check that a confirmation screen is displayed when the operation is complete.

## Setting voice tags

Calls can be made by saying the voice tag of a registered contact in the contact list. (→P.158)

- 1 Select “Manage Voice Tags”.
- 2 Select the desired item to be set.

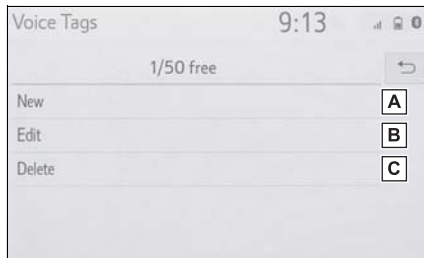

- A Select to register a new voice tag. (→P.272)
- B Select to edit a voice tag. (→P.273)
- C Select to delete a voice tag. (→P.273)

### ■ Registering a voice tag

Up to 50 voice tags can be registered.

- 1 Select “New”.
  - 2 Select the desired contact to register a voice tag for.
  - 3 Select “REC” and record a voice tag.
- When recording a voice tag,

do so in a quiet area.

“Play”: Select to play the voice tag.

**4** Select “OK” when voice tag registration is complete.

### ■ Editing a voice tag

**1** Select “Edit”.

**2** Select the desired contact to edit.

**3** Follow the steps in “Registering a voice tag” from step **3**. (→P.272)

### ■ Deleting the voice tag

**1** Select “Delete”.

**2** Select the desired contact and select “Delete”.

**3** Select “Yes” when the confirmation screen appears.

● Multiple data can be selected and deleted at the same time.

● Voice tags are deleted when the set language of the system is changed. (→P.60)

## Message settings screen

**1** Display the phone settings screen. (→P.265)

**2** Select “Messaging”.

**3** Select the desired item to be set.



**A** Select to set automatic message transfer on/off.

**B** Select to set automatic message readout on/off.

**C** Select to set updating message read status on phone on/off.

**D** Select to set display of messaging account names on the message screen on/off. When set to on, messaging account names used on the cellular phone will be displayed.

**E** Select to set adding the vehicle signature to outgoing messages on/off. The vehicle signature can be edited. (→P.274)

**F** Select to reset all setup items.

● Depending on the phone, these functions may not be available.

## Vehicle signature settings

**1** Select “Vehicle Signature”.

- 2 Select the desired item to be set.

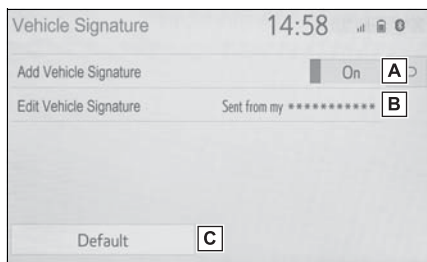

- A Select to set adding the vehicle signature to outgoing messages on/off.
- B Select to edit the vehicle signature. (→P.274)
- C Select to reset all setup items.

#### ■ Editing vehicle signature

- 1 Select “Edit Vehicle Signature”.
- 2 Enter desired signature with using keyboard.
- 3 Select “OK”.
- 4 Select “OK” on the confirmation screen, or select “Edit Again” when it needs to amend.



## Troubleshooting

If there is a problem with the hands-free system or a Bluetooth® device, first check the table below.

## Troubleshooting

### ■ When using the hands-free system with a Bluetooth® device

The hands-free system or Bluetooth® device does not work.

Likely cause	Solution
The connected device may not be a compatible Bluetooth® cellular phone.	For a list of specific devices which operation has been confirmed on this system, check with your Toyota dealer or the following website: <a href="https://www.toyota.com/audio-multimedia">https://www.toyota.com/audio-multimedia</a> in the United States, <a href="https://www.toyota.ca/connected">https://www.toyota.ca/connected</a> in Canada, and <a href="http://www.toyotapr.com/audio-multimedia">http://www.toyotapr.com/audio-multimedia</a> in Puerto Rico
The Bluetooth® version of the connected cellular phone may be older than the specified version.	Use a cellular phone with Bluetooth® version 2.0 or higher (recommended: Ver. 4.2). (→P.39)

### ■ When registering/connecting a cellular phone

A cellular phone cannot be registered.

Likely cause	Solution
An incorrect passcode was entered on the cellular phone.	Enter the correct passcode on the cellular phone.
The registration operation has not been completed on the cellular phone side.	Complete the registration operation on the cellular phone (approve registration on the phone).
Old registration information remains on either this system or the cellular phone.	Delete the existing registration information from both this system and the cellular phone, then register the cellular phone you wish to connect to this system. (→P.43)



A Bluetooth® connection cannot be made.

Likely cause	Solution
Another Bluetooth® device is already connected.	Manually connect the cellular phone you wish to use to this system. (→P.41)
Bluetooth® function is not enabled on the cellular phone.	Enable the Bluetooth® function on the cellular phone.

Likely cause	Solution
Automatic Bluetooth® connection on this system is set to off.	Set automatic Bluetooth® connection on this system to on when the engine switch is in ACC or ON. (→P.45)
Preferred device settings function on this system is set to on.	Set preferred device settings function on this system to off. (→P.46)
	Set the desired cellular phone to the highest automatic connection priority. (→P.46)

#### ■ When making/receiving a call

A call cannot be made/received.

Likely cause	Solution
Your vehicle is in a  area.	Move to where  no longer appears on the display.

#### ■ When using the phonebook

Phonebook data cannot be transferred manually/automatically.

Likely cause	Solution
The profile version of the connected cellular phone may not be compatible with transferring phonebook data.	For a list of specific devices which operation has been confirmed on this system, check with your Toyota dealer or the following website: <a href="https://www.toyota.com/audio-multimedia">https://www.toyota.com/audio-multimedia</a> in the United States, <a href="https://www.toyota.ca/connected">https://www.toyota.ca/connected</a> in Canada, and <a href="http://www.toyotapr.com/audio-multimedia">http://www.toyotapr.com/audio-multimedia</a> in Puerto Rico
Automatic contact transfer function on this system is set to off.	Set automatic contact transfer function on this system to on. (→P.268)
Passcode has not been entered on the cellular phone.	Enter the passcode on the cellular phone if requested (default passcode: 1234).
Transfer operation on the cellular phone has not completed.	Complete transfer operation on the cellular phone (approve transfer operation on the phone).

Phonebook data cannot be

edited.

Likely cause	Solution
Automatic contact transfer function on this system is set to on.	Set automatic contact transfer function on this system to off. (→P.268)

### ■ When using the Bluetooth® message function

Messages cannot be viewed.

Likely cause	Solution
Message transfer is not enabled on the cellular phone.	Enable message transfer on the cellular phone (approve message transfer on the phone).
Automatic transfer function on this system is set to off.	Set automatic transfer function on this system to on. (→P.268)

New message notifications are not displayed.

Likely cause	Solution
Notification of SMS/MMS/E-mail reception on this system is set to off.	Set notification of SMS/MMS/E-mail reception on this system to on. (→P.266)
Automatic message transfer function is not enabled on the cellular phone.	Enable automatic transfer function on the cellular phone.

■ In other situations

The Bluetooth® connection status is displayed at the top of the screen each time the engine switch is in ACC or ON.

Likely cause	Solution
Connection confirmation display on this system is set to on.	To turn off the display, set connection confirmation display on this system to off. (→P.46)

Even though all conceivable measures have been taken, the symptom status does not change.

Likely cause	Solution
The cellular phone is not close enough to this system.	Bring the cellular phone closer to this system.
Radio interference has occurred.	Turn off Wi-Fi® devices or other devices that may emit radio waves.

Likely cause	Solution
The cellular phone is the most likely cause of the symptom.	Turn the cellular phone off, remove and reinstall the battery pack, and then restart the cellular phone.
	Enable the cellular phone's Bluetooth® connection.
	Disable the Wi-Fi® connection of the cellular phone.
	Stop the cellular phone's security software and close all applications.
	Before using an application installed on the cellular phone, carefully check its source and how its operation might affect this system.

- For details, refer to the owner's manual that came with the cellular phone.

### 9-1. Connected services overview

Connected services .... **280**

Type A: Function achieved by using a smartphone or DCM ..... **281**

Type B: Function achieved by using DCM and the system ..... **284**

Type C: Function achieved by using DCM ..... **285**

Type D: Function achieved by using DCM and a smartphone ..... **287**

### 9-2. Connected services operation

Toyota apps ..... **289**

Destination Assist ..... **292**

### 9-3. Setup

Toyota apps settings ... **294**

## Connected services\*

\*: This function is not made available in some countries or areas.

**Connected services includes Toyota apps, Destination Assist, Service Connect, Dynamic Navigation, Wi-Fi® hotspot, Safety Connect and Remote Connect.**

## Functional overview

- The functions included are classified into the following four types.
- Type A: Function achieved by using a smartphone or an embedded cellular device in the vehicle (DCM: Data Communication Module) and the system
- Type B: Function achieved by using DCM and the system
- Type C: Function achieved by using DCM
- Type D: Function achieved by using DCM and a smartphone

Function	Type
Toyota apps	Type A
Destination Assist, Dynamic Navigation, Wi-Fi® hotspot	Type B
Safety Connect	Type C
Remote Connect, Service Connect	Type D

- Connected services functionality is dependent upon network recep-

tion level and signal strength.

- Each function is available in the following areas:
  - Toyota apps is available in the contiguous United States, Washington D.C., Alaska, Hawaii, the United States Virgin Islands, Puerto Rico and Canada.
  - Destination Assist is available in the contiguous United States, Washington D.C., Puerto Rico, Hawaii, the United States Virgin Islands, Canada, and limited areas of Alaska for vehicles that contain the appropriate map data.
  - Dynamic Navigation is available in the contiguous United States, Washington D.C. and Alaska.
  - Dynamic Navigation is not available in Puerto Rico, Canada, and the United States Virgin Islands.
  - Wi-Fi® hotspot is available in the contiguous United States, Washington D.C., Alaska and Hawaii.
  - Wi-Fi® hotspot is not available in Puerto Rico, Canada, and the United States Virgin Islands.
  - Safety Connect is available in the contiguous United States, Washington D.C., Alaska, Hawaii, the United States Virgin Islands, Puerto Rico and Canada.
  - Remote Connect is available in the contiguous United States, Washington D.C., Alaska, Hawaii, the United States Virgin Islands, Puerto Rico and Canada.
  - Service Connect is available in the contiguous United States, Washington D.C., Alaska, Hawaii, the United States Virgin Islands, Puerto Rico and Canada.

## Type A: Function achieved by using a smartphone or DCM

Of the functions included with connected services, the Toyota apps rely on the use of a smartphone or DCM.

- Using a smartphone
  - Toyota audio multimedia system enables applicable apps installed on a smartphone to be displayed on and operated from the screen via Bluetooth®.
- Via DCM
  - Toyota audio multimedia system enables applicable apps installed on the system to be displayed on and operated from the screen.

A few settings must be performed before Toyota apps can be used. (→P.283)

### By using a smartphone or DCM

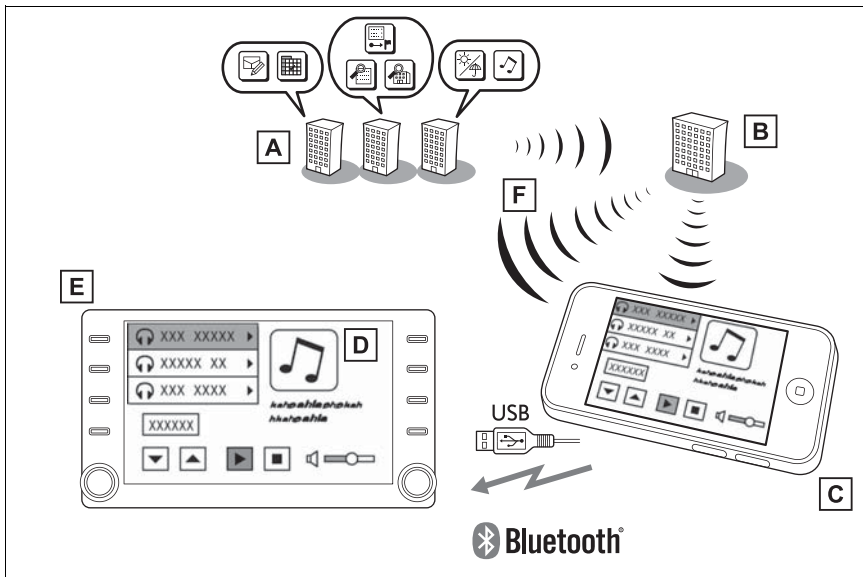

- A** Content provider  
Provides contents to the application server.

- B** Application server  
Provides applications to the system or a smartphone.
- C** Smartphone\*  
Using the Toyota mobile application, communication is relayed between the system, application server and content provider.
- D** Applications  
Display usable content from the content providers on the screen using the data connection of the connected smartphone or DCM.
- E** System  
Content received, via a smartphone or DCM, from content provider servers is displayed on the screen. The system is equipped with an application player to run applications.

**F** Via DCM

\*: For known compatible phones, refer to <https://www.toyota.com/connected-services> in the United States, <https://www.toyota.ca/connected> in Canada, and <http://www.toyotapr.com/connected-services> in Puerto Rico.

**Before using the function**

The required operations to activate applications and connect a smartphone to the system, and the registration steps for the connected services are explained in this section.

**Subscription**

- Toyota apps do not require an activation fee or monthly recurring fees.
- Services requiring a separate contract can also be used.\*

\*: For details, refer to <https://www.toyota.com/connected-services> or call 1-800-331-4331 in the United States, <https://www.toyota.ca/connected>

or call 1-888-869-6828 in Canada, and <http://www.toyotapr.com/connected-services> or call 1-877-855-8377 in Puerto Rico.

**Availability of function**

- Toyota apps is available in the contiguous United States, Washington D.C., Alaska, Hawaii, the United States Virgin Islands, Puerto Rico and Canada.
- 
- Data usage fees may apply while using Toyota apps. Confirm data usage fees before using this function.
  - For details regarding operation of the Toyota apps, refer to <https://www.toyota.com/connected-services> in the United States,



<https://www.toyota.ca/connected> in Canada, and <http://www.toyotapr.com/connected-services> in Puerto Rico.

- These functions are not made available in some countries or areas. Availability of functions of the Toyota apps is dependent on network reception level.

### ■ Initializing personal data

The personal data used in applications can be reset. (→P.63)

- The following personal data can be deleted and returned to their default settings:
    - Downloaded contents
    - Radio stations that were listened to
- 
- Once initialized, the data and settings will be erased. Pay much attention when initializing the data.

## Preparation before using Toyota mobile application

### ■ Settings required to use Toyota mobile application

Perform the settings in the following order.

- 1 Download the Toyota mobile application to your smartphone.
- 2 Open the Toyota mobile application on your smartphone and follow instructions. Bluetooth® Pairing is required.

In order to use Toyota mobile application, the following must first be

performed:

- Register a Bluetooth® phone with the hands-free system. (→P.36)
- 
- Applications can only be used when the Toyota mobile application has been downloaded to your smartphone, and the application is running.
  - Toyota mobile application operational procedures can also be confirmed by visiting <https://www.toyota.com/connected-services> in the United States, <https://www.toyota.ca/connected> in Canada, and <http://www.toyotapr.com/connected-services> in Puerto Rico.
  - If a Toyota mobile application is used while iPod audio/video is being played back, system operation may become unstable.

## **Type B: Function achieved by using DCM and the system\***

\*: Vehicles equipped with DCM

**The functionality of Destination Assist, Dynamic Navigation, and Wi-Fi® hotspot is made possible through the shared work of the DCM and the system.**

**Destination Assist and Dynamic Navigation are subscription-based telematics services that use Global Positioning System (GPS) data and embedded cellular technology to provide safety and security as well as convenience features.**

**These services are available by subscription on select, telematics hardware-equipped vehicles and supported by the Toyota response center, which operates 24 hours a day, 7 days a week.**

**For details about:**

- Dynamic Navigation: →P.85, 94, 116
- Wi-Fi® hotspot: →P.48

## **Before using the function**

### **■ Subscription**

- After you have signed the

Telematics Subscription Service Agreement and are enrolled, you can begin receiving services. A variety of subscription terms are available. Contact your Toyota dealer, or call 1-800-331-4331 in the United States, 1-888-869-6828 in Canada, and 1-877-855-8377 in Puerto Rico, for further subscription details. (→P.282)

### **■ Availability of functions**

- Destination Assist is available in the contiguous United States, Washington D.C., Puerto Rico, Hawaii, the United States Virgin Islands, Canada, and limited areas of Alaska for vehicles that contain the appropriate map data.
- Dynamic Navigation is available in the contiguous United States, Washington D.C. and Alaska.
- Dynamic Navigation is not available in Puerto Rico, Canada, and the United States Virgin Islands.
- Wi-Fi® hotspot is available in the contiguous United States, Washington D.C., Alaska and Hawaii.
- Wi-Fi® hotspot is not available in Puerto Rico, Canada, and the United States Virgin Islands.

## Type C: Function achieved by using DCM\*

\*: Vehicles equipped with DCM

### The functionality of Safety Connect is made possible by the use of a DCM.

For details, refer to “OWNER’S MANUAL”.

- Free/Open Source Software Information  
This product contains Free/Open Source Software (FOSS). The license information and/or the source code of such FOSS can be found at the following URL.  
<https://www.denso.com/global/en/opensource/dcm/toyota/>
- Exposure to radio frequency signals:  
The Toyota audio multimedia system installed in your vehicle includes a low power radio transmitter and receiver. The system receives and also sends out radio frequency (RF) signals.
- In August 1996, the Federal Communications Commission (FCC) adopted RF exposure guidelines with safety levels for mobile wireless phones. Those guidelines are consistent with the safety standards previously set by both U.S. and international standards bodies.
- ANSI (American National Standards Institute) C95.1 [1992]
- NCRP (National Council on Radiation Protection and Measurement) Report 86 [1986]
- ICNIRP (International Commission on Non-Ionizing Radiation Protection) [1996]
- These standards are based on comprehensive and periodic evaluations of the relevant scientific literature. Over 120 scientists, engineers, and physicians from universities, government health agencies, and industry reviewed the available body of research to develop the ANSI Standard (C95.1).
- The design of Toyota audio multimedia system complies with the FCC guidelines in addition to those standards.
- Contact with the Toyota response center is dependent upon the telematics device being in operative condition, cellular connection availability, navigation map data, and GPS satellite signal reception, which can limit the ability to reach the Toyota response center or receive support. Enrollment and Telematics Subscription Service Agreement required. A variety of subscription terms are available; charges vary by subscription term selected.
- The Toyota response center offers support in multiple languages.
- Select Safety Connect-subscribed vehicles are capable of communicating vehicle information. Please see the terms and conditions for additional details. Owners who do not wish to have their vehicle transmit this information can opt out at the time of enrollment or by calling 1-800-331-4331 in the United States, 1-888-869-6828 in Canada, and 1-877-855-8377 in Puerto Rico, and following the prompts for Safety Connect.
- For further details about the service, contact your Toyota dealer.
- Toyota audio multimedia functions are not subject to section 255 of the Telecommunications Act and the system is not TTY compatible.

- Certification
- ▶ For vehicles sold in the U.S.A., Canada and Puerto Rico

**FCC ID: JOYDA39**

**IC: 574B-DA39**

**FCC/IC WARNING:**

Changes or modifications not expressly approved by the manufacture could void the user's authority to operate the equipment.

This device complies with Part 15 of the FCC Rules and Industry Canada license-exempt RSS standards. Operation is subject to the following two conditions:

- (1) this device may not cause harmful interference, and
- (2) this device must accept any interference, including interference that may cause undesired operation of the device.

This equipment complies with IC RSS-102 radiation exposure limits set forth for uncontrolled environment.

The antennas used for this transmitter must be installed to provide a separation distance of least 20cm from all persons.

**FCC/IC AVERTISSEMENT:**

L'utilisateur est averti que les changements ou modifications non expressément approuvés par le fabricant pourraient annuler l'autorité de l'utilisateur à utiliser l'équipement.

Cet appareil est compatible avec la Partie 15 du règlement FCC et de la Licence de l'industrie canadienne et des normes exemptes de RSS. Opération soumise aux deux conditions suivantes :

- (1) ce appareil ne doit pas causer des interférences nuisibles, et
- (2) cet appareil doit accepté toutes les interférences, y compris les interférences qui peuvent entraîner un fonctionnement indésirable de l'appareil.

Cet appareil est compatible aux limites d'exposition aux radiation IC RSS-102 définies pour un environnement non contrôlé.

Les antennes utilisées pour cet émetteur doivent être installées à une distance d'au moins 20 cm de toutes les personnes.

## Type D: Function achieved by using DCM and a smartphone

The functionality of Remote Connect and Service Connect are made possible by the use of a DCM and a smartphone.

For details about these services, refer to <https://www.toyota.com/connected-services>.

## Remote Connect

Remote Connect is a smartphone application that lets you view and remotely control certain aspects of your vehicle.

### ■ Subscription

- After you sign the Telematics Subscription Service Agreement (see the Safety Connect section in “OWNER’S MANUAL”), download the Remote Connect app from your smartphone’s app store, and register within the app (or enroll and complete registration at the dealer), you can begin using these services.
- A variety of subscription terms are available. Contact your Toyota dealer, or call 1-800-331-4331 for further subscription details.

### ■ Availability of function

- Remote Connect is available in the contiguous United States, Washington D.C., Alaska, Hawaii, the United States Virgin Islands, Puerto Rico and Canada.
- 
- Availability of functions of the Remote Connect is dependent on network reception level.
  - Remote Connect should only be used by authorized users.
  - Laws in some communities may require that the vehicle be within view of the user when operating Remote Connect. In some states, use of Remote Connect may violate state or local laws. Before using Remote Connect, check your state and local laws.
  - Any malfunction of the vehicle should be repaired by your Toyota dealer.
  - Remote Connect is designed to work at temperatures above approximately -22 °F (-30 °C). This specification is related to the Remote Connect operation, but is dependent on the vehicle’s operating temperature range which may be different.
  - Content is subject to change without notice.
  - Additional information can be found at <https://www.toyota.com/connected-services> in the United States, <https://www.toyota.ca/connected> in Canada, and <http://www.toyotapr.com/connected-services> in Puerto Rico.

**WARNING**

- Operating Remote Connect incorrectly may lead to unforeseen accidents or malfunctions. Check the vehicle condition and assume full responsibility before using.

**Service Connect**

Service Connect uses DCM to collect and transmit vehicle data that allows Toyota to provide:

- Vehicle Health Report (VHR) (Safety Recalls, Service Campaigns, Current Vehicle Alerts, Required Maintenance, and Vehicle Condition Status)
- Maintenance Notifications
- Vehicle Alert Notifications

**■ Availability of function**

- Service Connect is available in the contiguous United States, Washington D.C., Alaska, Hawaii, the United States Virgin Islands, Puerto Rico and Canada.
- 
- Availability of functions of the Service Connect is dependent on network reception level.

## Toyota apps

Toyota apps is a function that enables certain apps installed on a smartphone or the system to be displayed on and operated from the system screen. Before the Toyota apps can be used, some setup needs to be performed. (→P.283)

For details about the functions and services provided by each application, refer to

<https://www.toyota.com/connected-services>

in the United States,

<https://www.toyota.ca/connected>

in Canada, and

<http://www.toyotapr.com/connected-services>

in Puerto Rico.

## Using Toyota apps

▶ From the “MENU” button

1 Press the “MENU” button.

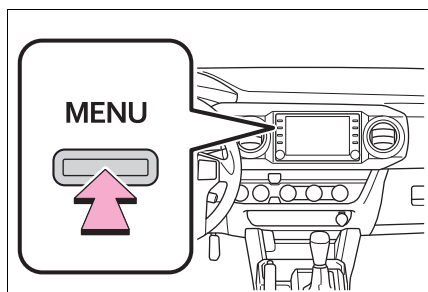

2 Select “Apps”.

3 Follow the steps in “From the “APPS” button” from step 2. (→P.289)

▶ From the “APPS” button

1 Press the “APPS” button.

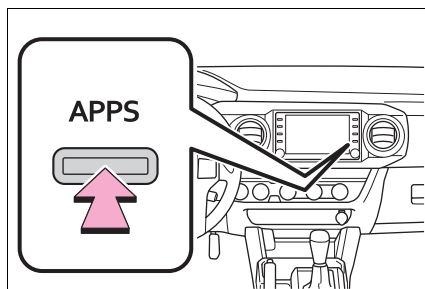

● If a specific application screen is displayed, press the “APPS” button again.

2 Select the desired application screen button.

: Select to activate an application.

“Update”: Select to update the applications. (→P.289)

: Displays the number of new notifications for the application

## Updating an application

When the Toyota apps is activated, an application may need to be updated. To update an application, it is necessary to download update data and install it.

### ■ Downloading update

If an update is available, “Update” can be selected.

**1** Select “Update” on the application screen. (→P.289)

**2** Check that downloading starts.

“Download in Background”: Select to operate other functions while downloading.

“Cancel”: Select to cancel updating.

**3** Check that downloading is complete.

“Later”: Select to install later. When this screen button is selected, the screen will return to the last displayed screen. To install the update data: (→P.290)

“See Detail”: Select to display detailed information on the update data.

“Install”: Select to install the update data. Follow the steps “Installing the update data” from step 2. (→P.290)

### ■ Installing the update data

After the downloading is complete, “Update” will be changed to “Install”.

**1** Select “Install” on the application screen. (→P.289)

**2** Select “Continue”.

“Later”: Select to postpone the installation of the update data and go back to the previous screen.

**3** Check that installing is started.

“Install in Background”: Select to operate other functions while installing.

**4** Select “OK” after the installing is complete.

● The Toyota apps cannot be operated while installing.

### If a message appears on the screen

When problems occur with starting the application player, a message will appear on the screen. Referring to the following items, identify the problem and take the suggested corrective action.

● “When it is safe and legal to do so, please ensure your Toyota mobile application is running and logged in on your phone.”

The Toyota mobile application cannot be connected to Bluetooth® SPP.

Refer to

<https://www.toyota.com/connected-services>

in the United States,

<https://www.toyota.ca/connected>

in Canada, and

<http://www.toyotapr.com/connected-services>

in Puerto Rico, to confirm if the phone is Bluetooth® SPP compatible or not, and then activate the Toyota mobile application.

● “Installation failed, please try again”

Installation can be attempted again by changing to the application screen and pressing the “Install” switch.

● “Application download error. Please try again later.”

Downloading can be attempted again by checking the communica-



tion status, changing to the application screen and pressing the “Download” switch again.

- “Download error, some Toyota mobile application functions may not work as expected. Please reinitiate the download process.”

The Toyota mobile application cannot be connected to Bluetooth® SPP.

Refer to

<https://www.toyota.com/connected-services>

in the United States,

<https://www.toyota.ca/connected>

in Canada, and

<http://www.toyotapr.com/connected-services>

in Puerto Rico, to confirm if the

phone is Bluetooth® SPP compatible or not, and then activate the Toyota mobile application.

Please ensure your Toyota mobile application is running and logged in on your phone while vehicle is not moving.

- “To use the services, Toyota mobile application needs to be running on your phone. For more information, please visit [toyota.com](http://toyota.com) or call 1-800-331-4331 in the United States, 1-888-869-6828 in Canada, and 1-877-855-8377 in Puerto Rico.”

The Toyota mobile application cannot be connected to Bluetooth® SPP.

Refer to

<https://www.toyota.com/connected-services>

in the United States,

<https://www.toyota.ca/connected>

in Canada, and

<http://www.toyotapr.com/connected-services>

in Puerto Rico, to confirm if the

phone is Bluetooth® SPP compatible or not, and then activate the Toyota mobile application.

- “Communication unsuccessful. Please try again.”

Communication was disconnected.

After a few moments, retry the operation.

### Entering keyword operation

A keyword can be entered to an application by the software keyboard or voice recognition function. For details about the functions and services provided by each application, refer to

<https://www.toyota.com/connected-services>

in the United States,

<https://www.toyota.ca/connected>

in Canada, and

<http://www.toyotapr.com/connected-services>

in Puerto Rico.

- The keyboard layout can be changed. (→P.60)

### Entering a keyword using the software keyboard

- 1 Display the application screen. (→P.289)
  - 2 Select the desired application screen button.
  - 3 Select the character entering space.
  - 4 Enter a search term, and then select “OK”.
  - 5 Entering characters will be reflected on the character entering space.
- For details on operating the keyboard: →P.30

### Entering a keyword using the voice recognition function

- 1 Display the application screen. (→P.289)
  - 2 Select the desired application screen button.
  - 3 Press the talk switch. (→P.158)
  - 4 Say the desired keyword.
- Completion of the keyword will be detected automatically.
- 5 Search results will be displayed on the screen.

### Destination Assist\*

\*: Premium Audio only

**Destination Assist provides you with live assistance for finding destinations via the Toyota response center. You can request either a specific business, address, or ask for help locating your desired destination by category, such as restaurants, gas stations, shopping centers or other Points of Interest (POI).**

**After you tell the agent your choice of destination, its coordinates are sent wirelessly to your vehicle’s navigation system.**

- The hands-free system cannot be used while Destination Assist is being used.

### Make a call with Destination Assist

#### ■ From the map screen

- 1 Press the “MAP” button.

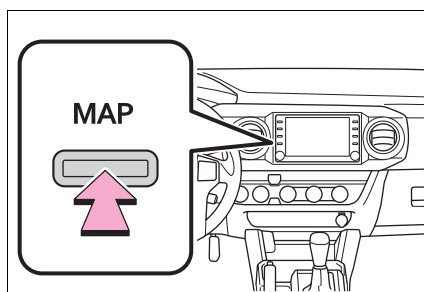



- 2 Select .

- 3 Follow the steps in “From the menu screen” from step 3.  
(→P.293)

■ **From the menu screen**

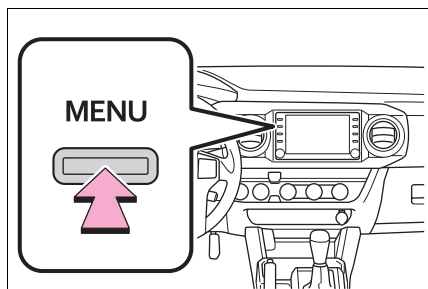
- 1 Press the “MENU” button.



- 2 Select “Destination”.
- 3 Select “Dest Assist”.
- 4 When an agent comes on the line, tell the agent the address, business name, or the type of POI or service.
- To adjust the call volume, select “-” or “+”, or use the volume switch on the steering wheel during the call.
  - To hang up the phone, select “End” or press the  switch on the steering wheel.
- 5 After the agent helps you determine your location of choice, select the screen button of the desired action.

“Save”: Select to register as a memory point.

“Go”: Select to set as a destination.

: Select to call the registered number.

## Toyota apps settings

Toyota apps settings can be changed.

### Displaying the Toyota apps settings screen

- 1 Press the “MENU” button.

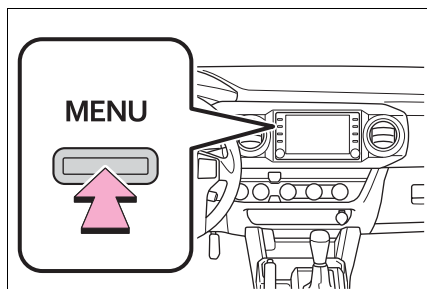

- 2 Select “Setup”.
- 3 Select “Toyota Apps”.
- 4 Select the desired items to be set.

### Toyota apps settings screen

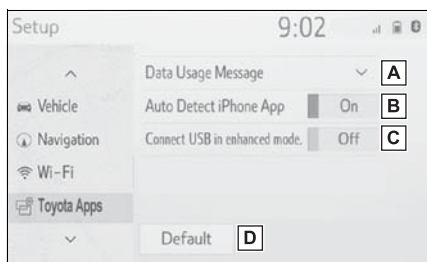

- A Select to set the pop up reminder for smartphone data usage. (→P.294)
- B Select to detect if an iPhone app is automatically turned

on/off.

- C Select to turn on/off the enhanced USB connection mode
  - When an iPhone is connected while this setting is set to “On”, communication with devices connected to other USB ports may not be possible. Also, depending on the device, charging may not be possible.
- D Select to reset all setup items to default setting.

### Data usage notification pop-up settings

The data usage notification pop-up, which indicates that the system will use an internet connection, can be enabled/disabled.

- 1 Display the Toyota apps settings screen. (→P.294)
- 2 Select “Data Usage Message”.
- 3 Change the setting as desired.

Index



Alphabetical Index..... 296

# Alphabetical Index

## A

<b>AM/FM/SiriusXM® Satellite Radio</b>	<b>125</b>
Available HD Radio™ technology	129
Caching a radio program	126
Displaying the radio ID	131
How to Subscribe to SiriusXM Satellite Radio	130
Overview	125
Presetting a station	126
Radio broadcast data system	128
Radio options	127
Refer to the table below to identify the problem and take the suggested corrective action	132
Selecting a station from the list	127
Smart favorites	131
Troubleshooting guide	129
Using HD Radio™ technology	128
<b>“Android Auto” button (“Menu” screen)</b>	<b>14</b>
<b>“Apple CarPlay” button (“Menu” screen)</b>	<b>14, 53</b>
<b>Apple CarPlay/Android Auto</b>	<b>53</b>
Establishing an Android Auto connection	54
Establishing an Apple CarPlay connection	53
<b>“Apps” button (“Menu” screen)</b>	<b>14, 289</b>
<b>“APPS” button</b>	<b>12, 289</b>

<b>“Audio” button (“Menu” screen)</b>	<b>14, 120</b>
<b>“Audio” button (“Setup” screen)</b>	<b>18, 145</b>
<b>“AUDIO” button</b>	<b>12, 120, 121</b>
<b>Audio settings</b>	<b>145</b>
Audio settings screen	145
Displaying the audio settings screen	145
<b>Audio/visual remote controls</b>	<b>144</b>

## B

<b>Basic function</b>	<b>12</b>
<b>Basic information before operation</b>	<b>26</b>
<b>Basic operation</b>	<b>72, 120</b>
<b>Bluetooth® audio</b>	<b>140</b>
Overview	140
Registering/Connecting a Bluetooth® device	142
<b>“Bluetooth” button (“Setup” screen)</b>	<b>18, 40</b>
<b>Bluetooth® phone message function</b>	<b>260</b>
Calling the message sender	263
Checking received messages	261
Displaying the message screen	260
Receiving a message	260
Replying to a message (dictation reply)	262
Replying to a message (quick reply)	262
<b>Buttons overview</b>	<b>12</b>
Operations of each part	12

**C**

**Clock settings**..... 14, 61  
**Command list** ..... 162  
 Command list overview ..... 162  
**Connected services** .....280  
**Connectivity settings** ..... 36

**D**

**“Data Services” button (“Setup” screen)** ..... 18, 172  
**Data services settings** ..... 172  
 Setting download methods... 172  
**Destination Assist** .....292  
**“Destination” button (“Menu” screen)** ..... 14, 84  
**Destination search** .....84  
**Destination search operation..**84  
 Destination screen ..... 84  
 One-touch setting home/favorite as a destination .....90  
 Searching by address .....87  
 Searching by contact.....87  
 Searching by Destination Assist .....86  
 Searching by emergency .....86  
 Searching by favorites list .....86  
 Searching by keyword.....85  
 Searching by point of interest.88  
 Searching by recent destinations .....86  
 Selecting search area .....85  
 Setting home as destination...85  
**Detailed navigation settings..**106  
 Detailed navigation settings screen ..... 107  
 Displaying the detailed navigation settings screen ..... 106

**“Display” button (“Menu” screen)**.....14, 33

**E**

**“ECO” button (“Information” screen)**.....19  
**Editing route** .....99  
 Displaying the edit route screen .....99  
**Entering letters and numbers/list screen operation**.....30  
 Entering letters and numbers .30  
 List screen .....31

**G**

**“General” button (“Setup” screen)**.....18, 60  
**General settings** .....60  
 Displaying the general settings screen.....60  
 General settings screen .....60  
**GPS (Global Positioning System)** ..... 114  
 Limitations of the navigation system ..... 114  
**Guiding the route**.....22  
 Deleting destinations .....22  
 Setting the destination.....22

**H**

**“HOME” button** .....12, 29  
**Home screen** .....29  
 Home screen operation .....29

## I

<b>“Info” button (“Menu” screen)</b>	<b>14, 19</b>
<b>Information display</b>	<b>170</b>
<b>“Information” screen</b>	<b>19</b>
<b>Initial screen</b>	<b>26</b>
Caution screen	26
Maintenance information	26
Restarting the system	26
<b>Internet radio</b>	<b>133</b>
Listening to internet radio	133
<b>iPod/iPhone (Apple CarPlay)</b>	<b>136</b>
Overview	136

## L

<b>Linking multi-information display and the system</b>	<b>35</b>
---------------------------------------------------------	-----------

## M

<b>“MAP” button</b>	<b>12, 72</b>
<b>Map database version and covered area</b>	<b>116</b>
Map information	116
Temporary updates of the map	116
<b>Map screen information</b>	<b>76</b>
Displaying information about the icon where the cursor is set	79
Displaying the map options screen	76
Standard map icons	80

<b>Map screen operation</b>	<b>74</b>
Current position display	74
Map scale	74
Map scroll operation	75
Orientation of the map	75
<b>Media operation</b>	<b>134</b>
<b>“MENU” button</b>	<b>12, 14</b>
<b>“Menu” screen</b>	<b>14</b>
“Menu” screen operation	14
<b>Mobile Assistant</b>	<b>167</b>
Connectable devices and available functions	167
Mobile Assistant operation	167
<b>Mobile Assistant operation</b>	<b>167</b>
<b>Multi-terrain Monitor</b>	<b>209</b>
Automatic display mode	211
Changing the Multi-terrain Monitor screen	213
Displaying the Multi-terrain Monitor screen	209
If you notice any symptoms	244
Multi-terrain Monitor precautions	233
Screen display and functions (for off-road)	216
Screen display and functions (for on-road)	225



## N

- Natural language understanding** ..... 161
- Navigation** ..... 72
  - Map screen overview ..... 72
- “Navigation” button (“Setup” screen)** ..... 18, 102
- Navigation operation**..... 21
- Navigation settings** ..... 102
  - Displaying navigation settings screen ..... 102
  - Navigation settings screen ... 102
  - Setting up areas to avoid .... 104
  - Setting up favorites list ..... 103
  - Setting up home ..... 102

## O

- Operating information**..... 147
  - Error messages ..... 154
  - File information..... 149
  - High-resolution sound source ..... 149
  - iPod ..... 148
  - Radio ..... 147
  - Terms ..... 153
- Operating the map screen**..... 21
  - Displaying the current position of the vehicle on the map screen ..... 21
  - Moving the map screen ..... 21
  - Zooming in/out the map ..... 21
- Other settings** ..... 60

## P

- Panoramic view monitor** ..... 183
  - Camera switch..... 183
  - Checking the front and around the vehicle ..... 186
  - Checking the rear and around the vehicle ..... 191
  - Checking the sides of the vehicle ..... 188
  - How to switch the display .... 184
  - If you notice any symptoms..207
  - Panoramic view monitor precautions..... 196
  - Screens ..... 183
- “Phone” button (“Menu” screen)** ..... 14, 248
- “Phone” button (“Setup” screen)** ..... 18, 265
- “PHONE” button** ..... 12, 248
- Phone operation (Hands-free system for cellular phones)**.248
- Phone settings** ..... 265
  - Contacts/Call history settings screen..... 267
  - Displaying the phone settings screen..... 265
  - Message settings screen..... 273
  - Notifications/display settings screen..... 266
  - Phone settings screen ..... 265
  - Sounds settings screen ..... 265

<b>Placing a call using the Bluetooth® hands-free system ...</b>	<b>253</b>
By call history .....	253
By contacts list .....	254
By favorites list .....	254
By home screen .....	256
By keypad .....	255
Calling methods on the Bluetooth® phone .....	253
<b>“POWER VOLUME” knob .</b>	<b>12, 26, 121</b>
<b>“Projection” button (“Menu” screen) .....</b>	<b>14</b>

## Q

<b>Quick reference .....</b>	<b>120, 248</b>
Functional overview .....	120
Phone screen operation .....	248

## R

<b>Radio operation .....</b>	<b>125</b>
<b>Rear view monitor system.....</b>	<b>174</b>
Driving precautions .....	174
If you notice any symptoms..	181
Rear view monitor system precautions.....	176
Screen description .....	175

<b>Receiving a call using the Bluetooth® hands-free system.....</b>	<b>256</b>
Incoming calls.....	256
<b>Receiving weather information .....</b>	<b>170</b>
Displaying weather screen ...	170
Weather guidance service ...	171
<b>Registering home .....</b>	<b>23</b>
Setting home as the destination .....	24
<b>Registering/Connecting a Bluetooth® device .....</b>	<b>36</b>
Profiles .....	39
Registering a Bluetooth® audio player for the first time .....	38
Registering a Bluetooth® phone for the first time.....	36
<b>Route guidance.....</b>	<b>95</b>
<b>Route guidance screen .....</b>	<b>95</b>
During freeway driving.....	96
Screen for route guidance .....	95
Turn list screen .....	98
Turn-by-turn arrow screen .....	98
When approaching intersection .....	97

**S**

<b>Screen adjustment</b> .....	<b>33</b>
Displaying the screen adjustment screen .....	33
<b>“SEEK TRACK” button</b> .....	<b>12</b>
AM/FM/SiriusXM® Satellite Radio .....	125
Bluetooth® audio .....	141
iPod/iPhone .....	137
USB memory .....	135
<b>Setting Bluetooth® details</b> .....	<b>40</b>
Bluetooth® setup screen .....	40
Connecting a Bluetooth® device .....	41
Deleting a Bluetooth® device .....	43
“Detailed Settings” screen .....	45
Displaying the Bluetooth® setup screen .....	40
Editing the Bluetooth® device information .....	43
Registering a Bluetooth® device .....	43
<b>Setup</b> .....	<b>102, 145, 265, 294</b>
“Setup” button (“Menu” screen) .....	14, 18
“Setup” screen .....	18
<b>Some basics</b> .....	<b>121, 249</b>
About the contacts in the contact list .....	252
Audio screen adjustment .....	123
Registering/Connecting a Bluetooth® phone .....	250
Reordering the audio source .....	122
Selecting an audio source .....	121
Sound settings .....	122
Turning the system on and off .....	121
USB port .....	122
Using the phone switch/microphone .....	251
Voice command system .....	124, 252
When selling or disposing of the vehicle .....	252
<b>Starting route guidance</b> .....	<b>91</b>
A route from the Cloud .....	94
Confirm destination screen .....	91
Route overview screen .....	92

**Status icon** ..... 16  
 Status icon explanation ..... 16

**Steering switch**  
 “MODE/HOLD” switch ..... 144  
 Phone switch ..... 251  
 SEEK/TRACK switch ..... 144  
 Talk switch ..... 158, 252  
 Volume control switch .. 144, 251

**Steering switches** ..... 144  
 Steering switch operation .... 144

**T**

**Talking on the Bluetooth® hands-free system** ..... 257  
 Call screen operation ..... 257  
 Incoming call waiting ..... 259  
 Sending tones ..... 258  
 Switching calls while a call is in progress ..... 259  
 Transmit volume setting ..... 258

**Tips for operating the audio/visual system** ..... 147

**Tips for operating the navigation system** ..... 114

**Touch screen** ..... 27  
 Touch screen gestures ..... 27  
 Touch screen operation ..... 28

**Toyota apps** ..... 289  
 Entering keyword operation . 291  
 Using Toyota apps ..... 289

**“Toyota Apps” button (“Setup” screen)** ..... 18, 294

**Toyota apps settings** ..... 294  
 Displaying the Toyota apps settings screen ..... 294  
 Toyota apps settings screen .294

**“Traffic” button (“Setup” screen)** ..... 18, 109

**“Traffic incidents” button (“Information” screen)** ..... 19, 81

**Traffic information** ..... 81  
 Displaying the traffic incidents screen ..... 81  
 Displaying traffic information on the map ..... 83

**Traffic settings** ..... 109  
 Displaying the traffic settings screen ..... 109  
 Screen for traffic settings ..... 109

**Troubleshooting** ..... 275

**“TUNE SCROLL” knob** ..... 12  
 AM/FM/SiriusXM® Satellite Radio ..... 125  
 Bluetooth® audio ..... 141  
 iPod/iPhone ..... 137  
 USB memory ..... 135

**Typical voice guidance prompts** ..... 99

## U

<b>USB memory</b> .....	134
Overview .....	134
<b>Use of information accumulated by navigation system</b> .....	113
Displaying the useful navigation information settings screen	113

## V

<b>“Vehicle Alert History” button (“Information” screen)</b> .....	19
<b>“Vehicle” button (“Setup” screen)</b> .....	18, 65
<b>Vehicle settings</b> .....	65
Displaying the vehicle settings screen .....	65
Maintenance.....	66
Setting dealer information .....	68
Setting the valet mode .....	68
Vehicle settings screen .....	65
<b>“Voice” button (“Setup” screen)</b> .....	18, 64
<b>Voice command system</b> .....	158
Using the voice command system .....	158
Voice command system operation .....	159

<b>Voice command system operation</b> .....	158
<b>Voice settings</b> .....	64
Displaying the voice settings screen.....	64
Voice settings screen .....	64

## W

<b>“Weather” button (“Information” screen)</b> .....	19, 170
<b>What to do if</b> .....	275
<b>“Wi-Fi” button (“Setup” screen)</b> .....	18, 49
<b>Wi-Fi® hotspot</b> .....	48
Changing the Wi-Fi® settings	49
Connecting a device to the in-vehicle access point .....	48
Wi-Fi® function operating hints .....	51

---



---

**For more information about the following items, see the “OWNER’S MANUAL”.**

- Fuel consumption
- Vehicle customization settings

## Map database information and updates

### END USER LICENSE AGREEMENT

#### END USER TERM

The content provided by HERE ( "Data" ) is licensed, not sold. By opening this package, or installing, copying, or otherwise using the Data, you agree to be bound by the terms of this agreement.

The Data is provided for your personal, internal use only and may not be resold. It is protected by copyright, and is subject to the following terms (this "End User License Agreement" ) and conditions which are agreed to by you, on the one hand, and HERE and its licensors (including their licensors and suppliers) on the other hand. For purposes of these terms, "HERE" shall mean (a) HERE North America, LLC with respect to Data for the Americas and/or the Asia Pacific region and (b) HERE Europe B.V. for Data for Europe, the Middle East and/or Africa.

The Data includes certain information and related content provided under license to HERE from third parties and is subject to the applicable supplier terms and copyright notices set forth at the following URL:[http://corporate.navteq.com/supplier\\_terms.html](http://corporate.navteq.com/supplier_terms.html).

#### TERMS AND CONDITIONS

**License Limitations on Use:** You agree that your license to use this Data is limited to and conditioned on use for solely personal, noncommercial purposes, and not for service bureau, timesharing or other similar purposes. Except as otherwise set forth herein, you agree not to otherwise reproduce, copy, modify, decompile, disassemble or reverse engineer any portion of this Data, and may not transfer or distribute it in any form, for any purpose, except to the extent permitted by mandatory laws.

**License Limitations on Transfer:** Your limited license does not allow transfer or resale of the Data, except on the condition that you may transfer the Data and all accompanying materials on a permanent basis if: (a) you retain no copies of the Data; (b) the recipient agrees to the terms of this End -User License Agreement; and (c) you transfer the Data in the exact same form as you purchased it by physically transferring the original media (e.g., the CD-ROM or DVD you purchased), all original packaging, all Manuals and other documentation. Specifically, Multidisc sets may only be transferred or sold as a complete set as provided to you and not as a subset thereof.

**Additional License Limitations:** Except where you have been specifically licensed to do so by HERE in a separate written agreement, and without limiting the preceding paragraph, your license is conditioned on use of the Data as prescribed in this agreement, and you may not (a) use this Data with any products, systems, or applications installed or otherwise connected to or in communication with vehicles capable of vehicle navigation, positioning, dispatch, real time route guidance, fleet management or similar applications; or (b) with, or in communication with, including without limitation, cellular phones, palmtop and handheld computers, pagers, and personal digital assistants or PDAs.

**Warning:** This Data may contain inaccurate or incomplete information due to the passage of time, changing circum-stances, sources used and the nature of collecting comprehensive geographic Data, any of which may lead to incorrect results.

**No Warranty:** This Data is provided to you “as is” , and you agree to use it at your own risk. HERE and its licensors (and their licensors and suppliers) make no guarantees, representations or warranties of any kind, express or implied, arising by law or otherwise, including but not limited to, content, quality, accuracy, completeness, effectiveness, reliability, fitness for a particular purpose, usefulness, use or results to be obtained from this Data, or that the Data or server will be uninterrupted or error free.

**Disclaimer of Warranty:** HERE AND ITS LICENSORS (INCLUDING THEIR LICENSORS AND SUPPLIERS) DISCLAIM ANY WARRANTIES, EXPRESS OR IMPLIED, OF QUALITY, PERFORMANCE, MERCHANTABILITY, FITNESS FOR A PARTICULAR PURPOSE OR NON-INFRINGEMENT. Some States, Territories and Countries do not allow certain warranty exclusions, so to that extent the above exclusion may not apply to you.

**Disclaimer of Liability:** HERE AND ITS LICENSORS (INCLUDING THEIR LICENSORS AND SUPPLIERS) SHALL NOT BE LIABLE TO YOU IN RESPECT OF ANY CLAIM, DEMAND OR ACTION, IRRESPECTIVE OF THE NATURE OF THE CAUSE OF THE CLAIM, DEMAND OR ACTION ALLEGING ANY LOSS, INJURY OR DAMAGES, DIRECT OR INDIRECT, WHICH MAY RESULT FROM THE USE OR POSSESSION OF THIS DATA; OR FOR ANY LOSS OF PROFIT, REVENUE, CONTRACTS OR SAVINGS, OR ANY OTHER DIRECT, INDIRECT, INCIDENTAL, SPECIAL OR CONSEQUENTIAL DAMAGES ARISING OUT OF YOUR USE OF OR INABILITY TO USE THIS DATA, ANY DEFECT IN THIS DATA, OR THE BREACH OF THESE TERMS OR CONDITIONS, WHETHER IN AN ACTION IN CONTRACT OR TORT OR BASED ON A WARRANTY, EVEN IF HERE OR ITS LICENSORS HAVE BEEN ADVISED OF THE POSSIBILITY OF SUCH DAMAGES. Some States, Territories and Countries do not allow certain liability exclusions or damages limitations, so to that extent the above may not apply to you.



**Export Control:** You agree not to export from anywhere any part of the Data or any direct product thereof except in compliance with, and with all licenses and approvals required under, applicable export laws, rules and regulations, including but not limited to the laws, rules and regulations administered by the Office of Foreign Assets Control of the U.S. Department of Commerce and the Bureau of Industry and Security of the U.S. Department of Commerce. To the extent that any such export laws, rules or regulations prohibit HERE from complying with any of its obligations hereunder to deliver or distribute Data, such failure shall be excused and shall not constitute a breach of this Agreement.

**Entire Agreement:** These terms and conditions constitute the entire agreement between HERE (and its licensors, including their licensors and suppliers) and you pertaining to the subject matter hereof, and supersedes in their entirety any and all written or oral agreements previously existing between us with respect to such subject matter.

**Severability:** You and HERE agree that if any portion of this agreement is found illegal or unenforceable, that portion shall be severed and the remainder of the Agreement shall be given full force and effect.

**Governing Law:** The above terms and conditions shall be governed by the laws of the State of Illinois (for Data for the Americas and/or the Asia Pacific region) or The Netherlands (for Data for Europe, the Middle East and Africa), without giving effect to (i) its conflict of laws provisions, or (ii) the United Nations Convention for Contracts for the International Sale of Goods, which is explicitly excluded. For any and all disputes, claims and actions arising from or in connection with the Data ( "Claims" ), you agree to submit to the personal jurisdiction of (a) the State of Illinois for Claims related to Data for the Americas and/or the Asia Pacific region provided to you hereunder, and (b) The Netherlands for Data for Europe, the Middle East and/or Africa provided to you hereunder.

**Government End Users:** If the Data is being acquired by or on behalf of the United States government or any other entity seeking or applying rights similar to those customarily claimed by the United States government, this Data is a “commercial item” as that term is defined at 48 C.F.R. ( “FAR” ) 2.101, is licensed in accordance with this End User License Agreement, and each copy of Data delivered or otherwise furnished shall be marked and embedded as appropriate with the following “Notice of Use” , and be treated in accordance with such Notice:

**NOTICE OF USE**

CONTRACTOR (MANUFACTURER/ SUPPLIER) NAME:

**HERE**

CONTRACTOR (MANUFACTURER/SUPPLIER) ADDRESS:

**425 West Randolph Street, Chicago, IL 60606.**

This Data is a commercial item as defined in FAR 2.101 and is subject to the End User License Agreement under which this Data was provided.

© 1987-2019\* HERE. All rights reserved. \*original publication date

If the Contracting Officer, federal government agency, or any federal official refuses to use the legend provided herein, the Contracting Officer, federal government agency, or any federal official must notify HERE prior to seeking additional or alternative rights in the Data.

© 1987-2019\* HERE. All rights reserved. \*original publication date

**END OF TERMS AND CONDITIONS**  
**EXHIBIT A END USER TERMS**

A. General Terms. Prior to the delivery of any Data to a user, Licensee shall obtain the user's agreement to terms and conditions of use substantially similar to, but no less protective of TCS, its licensors or VISA than the following terms:

"1. Personal Use Only. You agree to use this information for solely personal, non-commercial purposes, and not for service bureau, time-sharing or other similar purposes. You may not modify the information or remove any copyright notices that appear on the information in any way. You may not decompile, disassemble or reverse engineer any portion of this information, and may not transfer or distribute it in any form, for any purpose. Without limiting the foregoing, except for the in vehicle navigation system this information appears in, you may not use this information with any products, systems, or applications installed or otherwise connected to or in communication with vehicles, capable of vehicle navigation positioning, dispatch, real time route guidance, fleet management or similar applications.

2. No Warranty. This information is provided to you "as is," and you agree to use it at your own risk. AISIN AW CO, LTD, Inc. and its licensors (and their licensors and suppliers, collectively, "AISIN") make no guarantees, representations or warranties of any kind, express or implied, arising by law or otherwise, including but not limited to, and AISIN expressly disclaims any warranties regarding, content, quality, accuracy, completeness, effectiveness, reliability, fitness for a particular purpose, non-infringement, usefulness, use or results to be obtained from this information, or that the information or server will be uninterrupted or error free. Some states, territories and countries do not allow certain warranty exclusions, so to that extent, the above exclusion may not apply to you.

3. Disclaimer of Liability. AISIN SHALL NOT BE LIABLE TO YOU FOR ANY CLAIM, DEMAND OR ACTION, IRRESPECTIVE OF ITS NATURE, ALLEGING ANY LOSS, INJURY OR DAMAGES, WHETHER DIRECT, INDIRECT, INCIDENTAL, SPECIAL OR CONSEQUENTIAL DAMAGES, INCLUDING ANY LOSS OF PROFIT, REVENUE OR CONTRACTS ARISING OUT OF YOUR POSSESSION, USE OF OR INABILITY TO USE THIS INFORMATION, ANY DEFECT IN THE INFORMATION, OR THE BREACH OF THESE TERMS OR CONDITIONS, WHETHER IN AN ACTION IN CONTRACT OR TORT OR BASED ON A WARRANTY, EVEN IF AISIN OR ITS LICENSORS HAVE BEEN ADVISED OF THE POSSIBILITY OF SUCH DAMAGES. Some states, territories and countries do not allow certain liability exclusions or damages limitations, so to that extent the above may not apply to you.

4. Indemnity. You agree to indemnify, defend and hold AISIN and its licensors (including their respective licensors, suppliers, assignees, subsidiaries, affiliated companies, and the respective officers, directors, employees, shareholders, agents and representatives of each of them) free and harmless from and against any liability, loss, injury (including injuries resulting in death), demand, action, cost, expense, or claim of any kind or character, including but not limited to attorney's fees, arising out of or in connection with any use or possession by you of this information."

B. VISA. With respect to any VISA data, VISA specifically requires the following:

1. Licensee shall provide the Attribution to VISA with respect to the VISA data.
2. Licensee shall not allow data mining or downloading of the Information except in strictly limited quantities (a maximum of nine (9) locations per end-user search. An **end-user search** is a request by an end-user for a search of listings in a specific geographic area meeting certain criteria (for example, nearest listing to a waypoint or listings along a route segment). Any individual listing may be selected manually by the end-user for storage in a personal electronic address book or other form of memory in the navigation system. The personal electronic address book in the navigation system may be synchronized (not copied, reproduced, republished, uploaded, posted, transmitted, stored or distributed) with other devices operated by the end-user.
3. Licensee shall incorporate updates to the Data as soon as commercially feasible.
4. In addition to the general minimum terms included above, Licensee shall agree to require end-users to accept the following VISA-standard end user terms as a condition of access to the Data:
  - i.) All materials are the copyrighted property of AISIN and/or TELECOMMUNICATION SYSTEMS, INC. and its licensors. No material from this site may be copied, reproduced, republished, uploaded, posted, transmitted, stored, or distributed in any way, except that end user may download one listing (a location's name and address) on an individual non-automated basis per visiting session to the Licensee site or application, into end user's personal electronic address book. A personal electronic address book may not be shared by end user with other end users, nor may it be copied, reproduced, republished, uploaded, posted, transmitted, stored or distributed in any way. Use of the personal electronic address book must be for end user's personal, noncommercial use only.
  - ii.) End user may not use any material from AISIN's site or application for the purpose of compiling, enhancing, verifying, supplementing, or otherwise modifying VISA databases, lists, or directories of any kind, including, but not limited to, location databases, mailing lists, contact lists, marketing lists, geographic directories, or any other compilation or collation of information which is sold, rented, published, distributed, or in any manner supplied to a third party.

Certain business data provided by Infogroup © 2019, All Rights Reserved.



## Certification

FCC ID: AJDK101 AJDK102
[For 2.4 GHz Radio Transmitters] This equipment complies with FCC/ISED radiation exposure limits set forth for an uncontrolled environment and meets the FCC radio frequency (RF) Exposure Guidelines and RSS-102 of the ISED radio frequency (RF) Exposure rules. This equipment should be installed and operated keeping the radiator at least 20 cm or more away from person's body.
This transmitter must not be co-located or operated in conjunction with any other antenna or transmitter.
This device complies with Part 15 of FCC Rules and Innovation, Science, and Economic Development Canada licence-exempt RSS standard(s). Operation is subject to the following two conditions: (1) this device may not cause interference, and (2) this device must accept any interference, including interference that may cause undesired operation of this device.
Information to User - Alteration or modifications carried out without appropriate authorization may invalidate the user's right to operate the equipment.
FEDERAL COMMUNICATIONS COMMISSION SUPPLIER'S DECLARATION OF CONFORMITY Product Name: In-vehicle equipment Model Number: AVH-6098ZT AVH-3498,AVH-3598,AVH-5798,AVH-5898 Responsible Party Name: PIONEER ELECTRONICS (USA), INC. SERVICE SUPPORT DIVISION Address: 2050 W. 190TH STREET, SUITE 100 TORRANCE, CA 90504, U.S.A. Phone: 1-310-952-2915 URL: <a href="http://www.pioneerelectronics.com">http://www.pioneerelectronics.com</a>

IC: 775E-K101

[For 2.4 GHz Radio Transmitters]

This equipment complies with FCC/ISED radiation exposure limits set forth for an uncontrolled environment and meets the FCC radio frequency (RF) Exposure Guidelines and RSS-102 of the ISED radio frequency (RF) Exposure rules. This equipment should be installed and operated keeping the radiator at least 20 cm or more away from person's body.

[Pour 2,4 GHz émetteurs radio]

Cet équipement est conforme aux limites d'exposition aux rayonnements énoncées pour un environnement non contrôlé et respecte les règles des radioélectriques (RF) de la FCC lignes directrices d'exposition et d'exposition aux fréquences radioélectriques (RF) CNR-102 de l'ISDE. Cet équipement doit être installé et utilisé en gardant une distance de 20 cm ou plus entre le radiateur et le corps humain.

This device complies with Part 15 of FCC Rules and Innovation, Science, and Economic Development Canada licence-exempt RSSs. Operation is subject to the following two conditions: (1) This device may not cause interference; and (2) This device must accept any interference, including interference that may cause undesired operation of the device.

Le présent appareil est conforme aux la partie 15 des règles de la FCC et CNR d'Innovation, Sciences et Développement économique Canada applicables aux appareils radio exempts de licence. L'exploitation est autorisée aux deux conditions suivantes: (1) l'appareil ne doit pas produire de brouillage; (2) l'utilisateur de l'appareil doit accepter tout brouillage radioélectrique subi, même si le brouillage est susceptible d'en compromettre le fonctionnement.

La operación de este equipo está sujeta a las siguientes dos condiciones: (1) es posible que este equipo o dispositivo no cause interferencia perjudicial y (2) este equipo o dispositivo debe aceptar cualquier interferencia, incluyendo la que pueda causar su operación no deseada.

**NOM**



Gracenote, the Gracenote logo and logotype, “Powered by Gracenote”, MusicID, Playlist Plus and Media VOCS are either registered trademarks or trademarks of Gracenote, Inc. in the United States and/or other countries.



### **Gracenote® End User License Agreement - Music**

This application or device contains software from Gracenote, Inc. of Emeryville, California (“Gracenote”). The software from Gracenote (the “Gracenote Software”) enables this application to perform disc and/or file identification and obtain music-related information, including name, artist, track, and title information (“Gracenote Data”) from online servers or embedded databases (collectively, “Gracenote Servers”) and to perform other functions. You may use Gracenote Data only by means of the intended End-User functions of this application or device.

This application or device may contain content belonging to Gracenote's providers. If so, all of the restrictions set forth herein with respect to Gracenote Data shall also apply to such content and such content providers shall be entitled to all of the benefits and protections set forth herein that are available to Gracenote.

You agree that you will use Gracenote Data, the Gracenote Software, and Gracenote Servers for your own personal non-commercial use only. You agree not to assign, copy, transfer or transmit the Gracenote Software or any Gracenote Data to any third party. **YOU AGREE NOT TO USE OR EXPLOIT GRACENOTE DATA, THE GRACENOTE SOFTWARE, OR GRACENOTE SERVERS, EXCEPT AS EXPRESSLY PERMITTED HEREIN.**

You agree that your non-exclusive license to use the Gracenote Data, the Gracenote Software, and Gracenote Servers will terminate if you violate these restrictions. If your license terminates, you agree to cease any and all use of the Gracenote Data, the Gracenote Software, and Gracenote Servers. Gracenote reserves all rights in Gracenote Data, the Gracenote Software, and the Gracenote Servers, including all ownership rights. Under no circumstances will Gracenote become liable for any payment to you for any information that you provide. You agree that Gracenote, Inc. may enforce its rights under this Agreement against you directly in its own name.

The Gracenote service uses a unique identifier to track queries for statistical purposes. The purpose of a randomly assigned numeric identifier is to allow the Gracenote service to count queries without knowing anything about who you are. For more information, see the web page for the Gracenote Privacy Policy for the Gracenote service.

The Gracenote Software and each item of Gracenote Data are licensed to you “AS IS.” Gracenote makes no representations or warranties, express or implied, regarding the accuracy of any Gracenote Data from in the Gracenote Servers. Gracenote reserves the right to delete data from the Gracenote Servers or to change data categories for any cause that Gracenote deems sufficient. No warranty is made that the Gracenote Software or Gracenote Servers are error-free or that functioning of Gracenote Software or Gracenote Servers will be uninterrupted. Gracenote is not obligated to provide you with new enhanced or additional data types or categories that Gracenote may provide in the future and is free to discontinue its services at any time.

**GRACENOTE DISCLAIMS ALL WARRANTIES EXPRESS OR IMPLIED, INCLUDING, BUT NOT LIMITED TO, IMPLIED WARRANTIES OF MERCHANTABILITY, FITNESS FOR A PARTICULAR PURPOSE, TITLE, AND NON-INFRINGEMENT. GRACENOTE DOES NOT WARRANT THE RESULTS THAT WILL BE OBTAINED BY YOUR USE OF THE GRACENOTE SOFTWARE OR ANY GRACENOTE SERVER. IN NO CASE WILL GRACENOTE BE LIABLE FOR ANY CONSEQUENTIAL OR INCIDENTAL DAMAGES OR FOR ANY LOST PROFITS OR LOST REVENUES.**

copyright © 2000 to present Gracenote



Total Traffic and Weather Network, a division of TTWN Media Networks, LLC (“TTWN”), owns or holds the rights to the traffic, news, sports, weather, stocks and other data (the “TTWN Data”) and network through which it is delivered, together the “TTN Service”. Use of the TTN Service is subject to the terms of these Device End User Terms.

THE TTWN SERVICE IS INFORMATIONAL ONLY. YOUR USE OF TTWN SERVICE IS AT YOUR SOLE RISK. TTWN DATA IS PROVIDED “AS IS”, “WHERE IS”, AND “WHERE AVAILABLE”. TTWN AND ITS SUPPLIERS AND LICENSORS EXPRESSLY DISCLAIM ALL WARRANTIES WITH RESPECT TO THE TTWN SERVICE (INCLUDING, WITHOUT LIMITATION, THAT THE TTWN DATA WILL BE ERROR-FREE, THAT THE TTWN SERVICE WILL OPERATE WITHOUT INTERRUPTION OR THAT THE TTWN DATA WILL BE ACCURATE), EXPRESS, IMPLIED OR STATUTORY, INCLUDING, WITHOUT LIMITATION, THE IMPLIED WARRANTIES OF MERCHANTABILITY, NON-INFRINGEMENT, FITNESS FOR A PARTICULAR PURPOSE, OR THOSE ARISING FROM A COURSE OF DEALING OR USAGE OF TRADE.

TTWN AND ITS SUPPLIERS AND LICENSORS WILL NOT BE LIABLE TO YOU UNDER ANY LEGAL THEORY, INCLUDING CONTRACT, TORT, NEGLIGENCE OR STRICT LIABILITY, FOR ANY DIRECT, INDIRECT, INCIDENTAL, SPECIAL, PUNITIVE, CONSEQUENTIAL OR EXEMPLARY DAMAGES, INCLUDING BUT NOT LIMITED TO, DAMAGES FOR LOSS OF PROFITS, GOODWILL, USE, DATA OR OTHER INTANGIBLE LOSSES (EVEN IF TTWN, ITS SUPPLIERS OR LICENSORS HAS BEEN ADVISED OF THE POSSIBILITY OF SUCH DAMAGES), RESULTING FROM OR ARISING OUT OF YOUR USE OF, OR YOUR INABILITY TO USE, THE TTWN SERVICE, THIS AGREEMENT, OR ANY OTHER MATTER RELATING TO THE TTWN SERVICE.

SOME JURISDICTIONS DO NOT ALLOW THE EXCLUSION OF CERTAIN WARRANTIES OR THE LIMITATION OR EXCLUSION OF LIABILITY FOR INCIDENTAL OR CONSEQUENTIAL DAMAGES. ACCORDINGLY, SOME OF THE ABOVE LIMITATIONS MAY NOT APPLY TO YOU.

