

# 2015 Cadillac CUE Infotainment System

<b>Infotainment System</b> .....	3	<b>Rear Seat Infotainment</b> ...	36	<b>Phone</b> .....	108
<b>Introduction</b> .....	3	Rear Seat Entertainment (RSE)		Bluetooth (Overview) .....	108
Infotainment .....	3	System .....	36	Bluetooth (Infotainment	
Overview .....	3	Rear Seat Entertainment (RSE)		Controls) .....	109
Steering Wheel Controls .....	6	System (Platinum) .....	55	Bluetooth (Voice	
Using the System .....	7	<b>Navigation</b> .....	68	Recognition) .....	113
Software Updates .....	11	Using the Navigation		Text Messaging .....	114
<b>Radio</b> .....	11	System .....	68	Wireless Charging	
AM-FM Radio .....	11	Maps .....	76	(Escalade) .....	115
HD Radio Technology .....	15	Navigation Symbols .....	77	Wireless Charging (Except	
Satellite Radio .....	16	Destination .....	79	Escalade) .....	116
Radio Reception .....	22	OnStar® System .....	95	<b>Settings</b> .....	118
Backglass Antenna .....	22	Settings .....	96	Teen Driver .....	120
Multi-Band Antenna .....	23	Global Positioning		<b>Trademarks and License</b>	
Pandora Internet Radio .....	23	System (GPS) .....	98	<b>Agreements</b> .....	122
<b>Audio Players</b> .....	27	Vehicle Positioning .....	98	<b>Index</b> .....	i-1
CD Player .....	27	Problems with Route			
USB/SD Port .....	29	Guidance .....	99		
SD Card Reader .....	33	If the System Needs			
Auxiliary Jack .....	34	Service .....	99		
Bluetooth Audio .....	34	Map Data Updates .....	100		
<b>OnStar System</b> .....	35	Database Coverage			
		Explanations .....	100		
		<b>Voice Recognition</b> .....	100		



## Introduction

### Infotainment



The names, logos, emblems, slogans, and vehicle body designs appearing in this manual including, but not limited to, GM, the GM logo, CADILLAC, CADILLAC Emblem and CADILLAC CUE are registered trademarks of General Motors LLC., its subsidiaries, affiliates, or licensors.

For vehicles first sold in Canada, substitute the name General Motors of Canada Limited for Cadillac Motor Division, whenever it appears in this manual.

This manual describes features that may or may not be on the vehicle because of optional equipment that was not purchased on the vehicle, model variants, country specifications, features/applications that may not be available in your region, or changes subsequent to the printing of this manual.

Keep this manual with the owner manual in the vehicle, so it will be there if it is needed. If the vehicle is sold, leave this manual in the vehicle.

## Overview

Read the following pages to become familiar with the infotainment system features.

### **Warning**

Taking your eyes off the road for too long or too often while using any infotainment feature can cause a crash. You or others could be injured or killed. Do not give extended attention to infotainment tasks while driving. Limit your glances at the vehicle displays and focus your attention on driving. Use voice commands whenever possible.

## 4 Infotainment System

The infotainment system has built-in features intended to help avoid distraction by disabling some functions when driving. These functions may gray out when they are unavailable. Many infotainment features are also available through the instrument cluster and steering wheel controls.

Before driving:

- Become familiar with the operation, faceplate buttons, and screen buttons.
- Set up the audio by presetting favorite stations, setting the tone, and adjusting the speakers.
- Set up phone numbers in advance so they can be called easily by pressing a single button or by using a single voice command if equipped with Bluetooth phone capability.

See “Defensive Driving” in the owner manual.

To play the infotainment system with the ignition off, see “Retained Accessory Power (RAP)” in the owner manual.

### Customer Assistance

Assistance is available to help with Bluetooth pairing, other mobile device interface, and operation support of the CUE infotainment system. Specialists are available when calling this Customer Assistance number.



U.S.: 1-855-428-3669  
(855 4 CUE NOW)

Canada: 1-888-446-2000 (Canadian Cadillac Customer Care Centre)



### Infotainment System

The infotainment system is controlled by using the touchscreen, the buttons below the touchscreen, steering wheel controls, and voice recognition.



1.  (Power and Mute)
2. Volume
3.  (Home Page)

### Power (On/Off/Mute)

- When off, press  (1) to turn the system on. Press and hold to turn off.
- When on, press  to mute the system. Press  again to unmute the system.

### Retained Accessory Power (RAP)

The vehicle has RAP. When in RAP the audio system can be played even after the ignition is turned off. See “Retained Accessory Power (RAP)” in the owner manual.

### Volume

The black area above the chrome bar (2) is used to increase or decrease the volume. There are three ways to adjust the volume:

- Slide a finger.
- Press.
- Press and hold.

### Rear Seat Armrest Control Panel

If equipped, there is a control panel in the center of the rear seatback. See “Armrest Storage” in the owner manual.

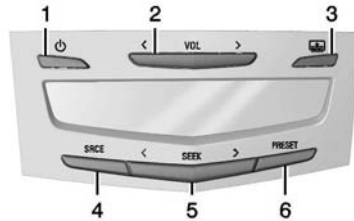

1. (Power): Press to turn the power on or off for the sourced audio or media playback and sunshade control button (if equipped).
2. (Volume): Press the left or right arrow to adjust the volume of current playback.
3. (Sunshade Switch): Press and release the switch to control the rear window sunshade.
4. SRCE (Source): Press to change the source of playback.
5. : Press the left or right arrow to go to the previous or next station on the radio or track on a media source.

6. PRESET: Press to go to a saved favorite.

### Home Page

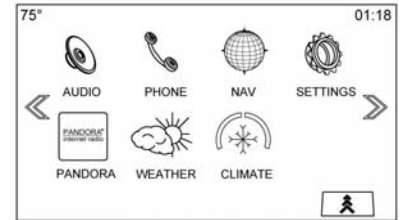

The Home Page is where application icons are accessed. Some features are disabled when the vehicle is moving.

The Home Page can be set up to have up to five pages with eight icons per page.

Press or , or slide a finger left/right across the screen to access the pages of icons.

**(Next)**: Press to go to the next Home Page.

## 6 Infotainment System

⏪ **(Previous):** Press to go to the previous Home Page.

⬆️ **(Interaction Selector):** Press to display the favorites list.

Press and hold a location within the favorites area to begin the process of saving a favorite application.

Press the application icon to store as a favorite, and the name of the application will be shown in favorites.

**Home:** Press to go back to the Home Page to start a different application.

### Managing Home Page Icons

1. Press and hold any of the Home Page icons to edit that icon.
2. Drag the icon to a new location on the Home Page or to save it to the applications tray.
3. Press  to exit edit mode.

### Steering Wheel Controls

The infotainment steering wheel controls can be used to control the infotainment features displayed in the instrument cluster.

When in Valet Mode (if equipped), access to the infotainment functions is disabled. See *Settings* on page 118.

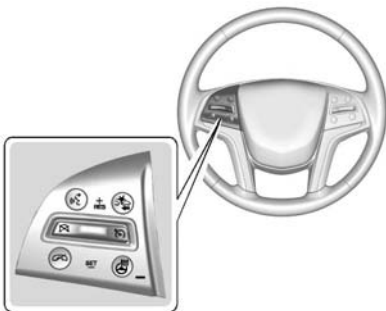

📞 **(Press to Talk):** Press to answer an incoming call or to start a voice recognition. See *Bluetooth (Overview)* on page 108 or *Bluetooth (Infotainment Controls)* on page 109 or *Bluetooth (Voice Recognition)* on page 113 and “OnStar Overview” in the owner manual.

📞 **(End Call):** Press to decline an incoming call, or end a current call. Press to mute or unmute the infotainment system when not on a call.



**< or >**: Press the five-way control to the left or right to go to the previous or next area in the display or to the previous or next menu.

**^ or v**: Press the five-way control up or down to go up or down in a list or page.

**SEL**: Press to select a highlighted menu item.

**△ or ▽ (Next or Previous Favorite)**: Press to go to the next or previous favorite when listening to the radio. Press to go to the next or previous track when listening to a media source.

**⏮ + or ⏭ - (Volume)**: Press to increase or decrease the volume.

## Using the System

### Audio

Press the AUDIO icon to display the active audio source page. Available sources are AM, FM, XM, CD (if equipped), My Media, USB, SD, Bluetooth, and AUX Input.

### Phone

Press the PHONE icon to display the Phone main page. See *Bluetooth (Overview) on page 108* or *Bluetooth (Infotainment Controls) on page 109* or *Bluetooth (Voice Recognition) on page 113*.

### NAV/ OnStar NAV

Press the NAV icon to display the navigation map or OnStar<sup>®</sup> Turn-by-Turn Navigation. See *Using the Navigation System on page 68* or “OnStar Navigation” in the owner manual.

### Apps

If equipped, this feature is available through the Apps icon on the radio Home Page. Downloading and using Apps requires a Bluetooth Internet connection as part of a smartphone or other mobile device data service plan. On most smartphones, activation is in the device’s Settings menu under Mobile Network Sharing, Personal Hotspot, Mobile Hotspot, Bluetooth

Tethering, or similar. After activation of the hotspot on the smartphone, complete the Bluetooth pairing process using the Phone icon on the radio Home Page. After pairing the phone, press the Apps icon on the radio Home Page. Follow the prompts to configure the Internet connection and set up an account. See [www.cadillac.com/cue](http://www.cadillac.com/cue) (U.S.) or [www.cue.cadillac.ca](http://www.cue.cadillac.ca) (Canada).

### Settings

Press the SETTINGS icon to display the Settings menu. See *Settings on page 118*.

### Energy (If Equipped)

Press the ENERGY leaf icon to display energy flow on the hybrid vehicle. See the owner manual.

### Pandora (If Equipped)

Press the PANDORA icon to begin Pandora<sup>®</sup>. See *Pandora Internet Radio on page 23*.

## 8 Infotainment System

---

### Weather (If Equipped)

Press the WEATHER icon to display the Weather main page. See “SiriusXM Travel Link (If Equipped)” under *Satellite Radio on page 16*.

### OnStar (If Equipped)

Press the ONSTAR icon to display the OnStar main page and start OnStar voice recognition. See “OnStar Overview” in the owner manual.

### Climate

Press the CLIMATE icon to display the Climate main page. See “Dual Automatic Climate Control System” in the owner manual.

### Rear Climate (If Equipped)

Press the R. CLIMATE icon to display the Rear Climate main page. See “Rear Climate Control System” in the owner manual.

### Video (If Equipped)

Press the VIDEO icon to display the video Rear Seat Entertainment main page. See *Rear Seat Entertainment (RSE) System on page 36* or *Rear Seat Entertainment (RSE) System (Platinum) on page 55*.

### Applications Tray



The applications tray is at the top center of the screen. The applications tray can have three to five applications.

To add an application from the Home Page to the applications tray:

1. Press and hold any icon on the Home Page to enter edit mode.

2. Drag the icon to the applications tray.

To remove an item from the applications tray, drag the icon from the applications tray back to the Home Page.

Adding or removing applications from the applications tray will not remove them from the Home Page.

### Touchscreen Buttons

Touchscreen buttons show on the screen when available. When a function is unavailable, the button may gray out. When a function is selected, the button may highlight.

### Proximity Sensing

The infotainment system uses proximity sensing. When enabled, certain screen buttons and features will become visible when a hand approaches the screen. When the hand is removed, these features fade. Proximity sensing can be disabled in the Settings applications in the Display menu options.



### Haptic Feedback

Haptic feedback is a pulse that occurs when a button is pressed on the screen or when buttons below the screen are pressed.

### Infotainment Gestures

Use the following finger gestures to control the infotainment system.

#### Press/Tap

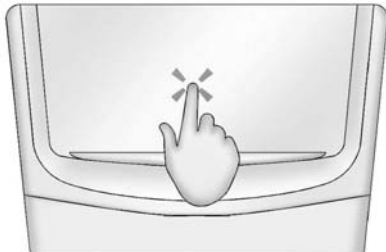

Press/Tap is used to select a button or option, activate an application, or change the location inside a map.

#### Press and Hold

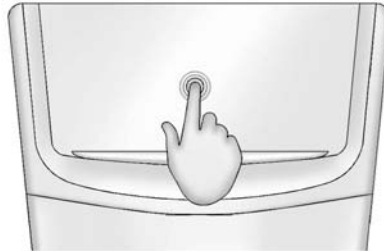

Press and hold can be used to start another gesture, or to move or delete an application.

#### Drag

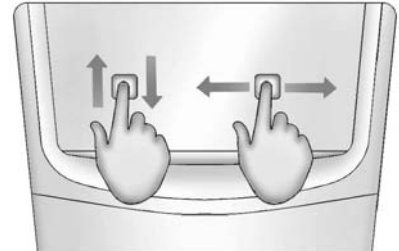

Drag is used to move applications on the Home Page, or to pan the map. To drag the item, it must be held and moved along the screen to the new location. This can be done up, down, right, or left.

## 10 Infotainment System

---

### Nudge

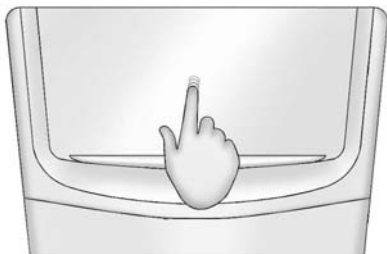

Nudge is used to move items a short distance on a list or a map. To nudge, hold and move the selected item up or down to a new location.

### Fling or Swipe

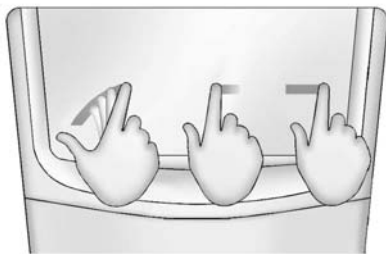

Fling or swipe is used to scroll through a list, pan the map, or change page views. Do this by placing a finger on the screen then moving it rapidly up and down or right and left.

### Spread

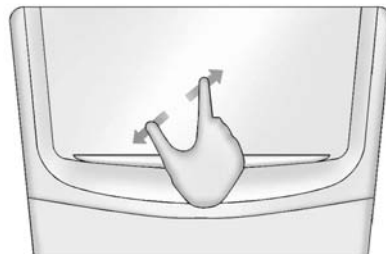

Spread is used to zoom in on a map, certain images, or a web page. Place finger and thumb together on the screen, then move them apart.

## Pinch

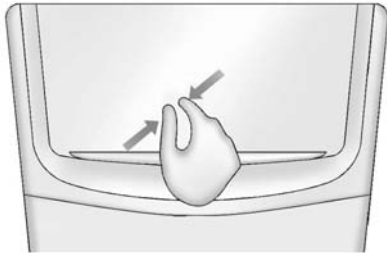

Pinch is used to zoom out on a map, certain images, or a web page. Place finger and thumb apart on the screen, then move them together.

## Cleaning High Gloss Surfaces and Vehicle Information and Radio Displays

For vehicles with high gloss surfaces or vehicle displays, use a microfiber cloth to wipe surfaces.

Before wiping the surface with the microfiber cloth, use a soft bristle brush to remove dirt that could scratch the surface. Then use the microfiber cloth by gently rubbing to clean. Never use window cleaners or solvents. Periodically hand wash the microfiber cloth separately, using mild soap. Do not use bleach or fabric softener. Rinse thoroughly and air dry before next use.

## Software Updates

See the following websites for information:

### Cadillac

In the U.S., see [www.cadillac.com](http://www.cadillac.com).

In Canada, see [www.cadillac.ca](http://www.cadillac.ca).

## Radio

### AM-FM Radio

#### Playing the Radio

While on the audio main page the available sources are: AM, FM, XM (if equipped), CD (if equipped), My Media, USB, SD, Bluetooth, and AUX Input.

- Press the RADIO screen button to scroll through AM, FM, or SiriusXM<sup>®</sup> (if equipped).
- Press the MEDIA screen button to scroll through CD (if equipped), My Media, USB, SD, Bluetooth, and AUX Input.

#### Infotainment System Settings

Press the RADIO screen button to access broadcast sources.

Press the MENU screen button to display the following menus:

#### Tone Settings:

- Bass, Midrange, and Treble:  
Press + or - to adjust.

## 12 Infotainment System

---

- **Surround Control:**  
If equipped, press + or – to adjust the volume of the seat speakers.
- **Balance:** Press < or > for more sound from the left or right speakers. The middle position balances the sound between the left and right speakers.
- **Fade:** Press ^ or v for more sound from the front or rear speakers. The middle position balances the sound between the front and rear speakers.

**EQ (Equalizer) Settings:** The available choices are Custom or Talk.

### DSP Modes:

- If equipped with Bose® Studio Surround®/Bose® Centerpoint® Surround sound system it will have four DSP modes. The proprietary Bose® Digital Signal Processing (DSP) delivers balanced sound specifically for the driver, rear-seat passengers

or the entire cabin. It is used to provide a choice of four different listening experiences. DSP can be used to provide a choice of four different listening experiences. DSP can be used while listening to the audio system. The type of DSP selected is displayed on the screen.

- **Normal:** Adjusts the audio to provide the best sound for all seating positions.
- **Driver:** Adjusts the audio to provide the best sound for the driver.
- **Rear:** Adjusts the audio to provide the best sound for the rear seat occupants.
- **Centerpoint:** Turns on Bose® Centerpoint® surround technology. This setting creates a surround sound listening experience from nearly any audio source; existing stereo CD collection, satellite radio, and MP3

players. For more information on Bose® Centerpoint® surround technology, visit [www.bose.com/centerpoint](http://www.bose.com/centerpoint).

**Auto Volume:** If equipped, this feature adjusts the volume based on vehicle speed. Select the level between off, low, medium - low, medium, medium - high, or high. Press < Back to go back to the previous menu.

**AudioPilot® Noise Compensation Technology:** If equipped, this feature adjusts the volume based on the noise in the vehicle and speed. When turned ON, AudioPilot® detects ambient noise and vehicle speed to continuously adjust many aspects of the audio signal so that your music will sound the same at a set volume level.

The options are ON and OFF.

This feature is most effective at lower radio volume settings where background noise can affect how well you hear the music being played through your vehicle's audio

system. At higher volume settings, where the music is much louder than the background noise, there may be little or no adjustments by AudioPilot®.

For more information on Bose® AudioPilot® noise compensation technology, visit [www.bose.com/audiopilot](http://www.bose.com/audiopilot).

**Tag Song:** If equipped, press to tag song information, including artist and title, to transfer to an iPod®. If the iPod is not attached, the information will be transferred when it is attached. Press OK to go back to the Now Playing view.

**Timeshift:** Timeshift is the recording of a radio station for up to 25 minutes. See “Timeshifting” later in this section.



**HD Radio:** For AM and FM only, press to turn HD reception on or off. Press  Back to go back to the previous menu.

**Update Station List:** For AM and FM only, press to update the station list. Press  Back to go back to the previous menu.

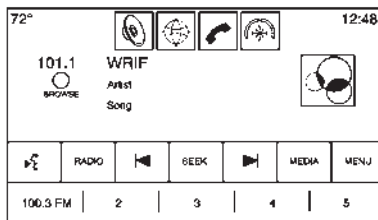

## Finding a Station

### Seeking a Station



Press  or  to search for the previous or next strongest station.

### Tuning a Station

Press the SEEK screen button to switch to TUNE. Press again to change back. Press  or  to manually search for a station.

## Storing Radio Station Presets

Favorites are stored in the area at the bottom of the screen.

Up to 60 preset stations can be stored under the following:

**AM, FM, SiriusXM (if equipped), HD Radio Stations:** Press and hold a favorite button to save the current station as a favorite. Press a favorite button to recall a favorite station.

### Mixed-Audio Favorites

Favorites that can be stored include radio stations, navigation, applications, contacts, tone settings, artists, songs, albums, podcasts, etc.

## 14 Infotainment System

72° [TP]					12:48				
WRIF	99.5	3	Mika	5					
99.5	Celine	8	9	10					
11	Tag	Tone 1 4.0	Tone 2	15					

To scroll through the favorites:

- Drag up along the top of the favorites. To close the favorites, drag them down.
- Slide a finger to the right or left to scroll through each page of favorites. A indicates which page is being viewed.

**Tone Settings:** While viewing the tone settings and lifting up the favorite buttons, press and hold to store a tone setting. Press a screen button in the favorite area to recall a favorite tone setting.

**Pandora Radio Stations:** Press and hold a screen button to store the Pandora application. Pandora favorite stations work when Pandora is launched.

The number of favorites displayed is automatically adjusted by default, but can be manually adjusted in the Settings menu under Radio and then Number of Favorites Shown.

### Timeshifting

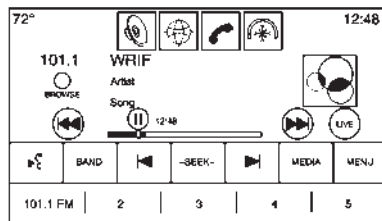

The audio system can record live radio for up to 25 minutes. When tuned to a station, the system automatically begins recording the audio along with the associated

metadata. Timeshift must be turned on in the menu before recording can take place.



Press to pause playback of the audio and to initiate timeshift mode. Press to resume playback of the live audio.

When timeshifting begins, a time is indicated on the right of the play/pause indicator. This time initially indicates the time of day at which playback is paused. This time continues to show as long as the system is in a paused mode and the buffer continues to fill.

### Buffer Reset

The buffer will reset anytime the broadcast band or stations/channels are changed. Changing to a media source while in pause mode will not reset the buffer.

### Rewinding or Fast Forwarding a Timeshifted Broadcast

- Press and hold the  indicator to reverse playback at a rate of 15 times the rate of normal playback.
- Press and hold the  indicator to advance playback at a rate of 15 times the rate of normal playback. The timeshift buffer can be advanced up to the end of the timeshift buffer and return to live mode.

### Returning to Live Broadcast

If listening to timeshifted radio, press the LIVE button to return to live radio.

### Timeshifting and Station/Channel Lists

If browsing a station/channel list is started while listening to the timeshift content, the list content is shown in live time, not buffered time.

### Skipping Back in a Broadcast

For programs with metadata, pressing the previous button less than five seconds into a program will make the system skip to the beginning of the previous program. If more than five seconds into the current song/program, the system starts at the beginning of the current program. If no metadata is available, the system skips back 25 seconds.

### Reaching the End of the Buffer



If the audio is paused and the 25 minute buffer is reached, the buffer continues recording the latest content and will erase the oldest content. When playback is started, the content played will be the last 25 minutes in the buffer.

## HD Radio Technology

HD Radio<sup>®</sup> Technology is a free service with features such as static-free sound, more stations built onto the frequency such as HD2 and HD3, and on-screen information such as artist and song title.

### Channel Access

To access HD Radio channels:

1. Tune the radio to the channel. If the channel is broadcasting HD Radio Technology, the radio will automatically switch to digital audio, indicated with an HD logo if HD Radio is turned on.
2. Press  or  to tune to the previous or next HD Radio channel.

There may be a delay before the channel starts playing.

The HD Radio channel number is indicated next to the logo.

HD Radio channels can be saved as favorites. Songs can be tagged for download.

When connected to iTunes<sup>®</sup>, the Sync button on the device may need to be pressed to transfer the tags to iTunes.

See *AM-FM Radio* on page 11 or *USB/SD Port* on page 29.

For a list of all channels, see [www.hdradio.com](http://www.hdradio.com).

### Troubleshooting

**Digital Audio Delay:** Wait for the signal to process. This can take several seconds.

**Volume Change, Audio Skip, Echo, Digital Audio Lost:** Channel signal strength may be weak or the channel is out of range. Verify proper reception on another channel.

If the HD Radio signal loses reception while listening to channel HD1, the radio will go back to the main non-HD Radio channel.

If the HD Radio signal loses reception while listening to channels HD2 to HD8, the radio mutes until the signal can be recovered or until the channel is changed.

HD can be disabled if driving in a weak signal area. Press Menu from the AM/FM screens, then press HD Radio to toggle HD on and off.

## Satellite Radio

### SiriusXM Satellite Radio Service (If Equipped)

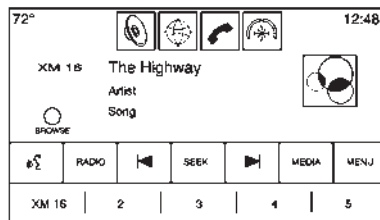

Vehicles with a valid SiriusXM satellite radio subscription can receive SiriusXM programming.

SiriusXM satellite radio has a wide variety of programming and commercial-free music, coast to coast, and in digital-quality sound. See [www.siriusxm.com](http://www.siriusxm.com) or call 1-866-635-2349 in the U.S. In Canada, see [www.xmradio.ca](http://www.xmradio.ca) or call 1-877-209-0079.

When SiriusXM is active, the station name, number, category name, song title, and artist display on the screen.

### SiriusXM Menu

Pressing the MENU screen button may display the following:

**Tone Settings:** Press + or - to adjust the tone settings. See *AM-FM Radio* on page 11.

**Tag Song:** Press the Tag Song button to tag the current artist and song information.

When connected to iTunes<sup>®</sup>, the Sync button on the device may need to be pressed to transfer the tags to iTunes.



**Timeshift:** Press to turn Timeshift on or off. See *AM-FM Radio* on page 11.

**TuneSelect:** For SiriusXM only, this feature allows alerts to be set for artists or songs that are played on any other channel. Press TuneSelect on the menu during playback of a desired song or artist to set an alert. Press Manage TuneSelect to turn the alerts On and Off or manage the saved selection of Artists or Songs. To unselect an alert, press the Song or Artist. To delete an alert, press -. Press **←** Back to go back to the previous menu.

**Auto Volume:** If equipped, this feature adjusts the volume based on the vehicle speed. See *AM-FM Radio* on page 11.

### Bose AudioPilot Noise

#### Compensation Technology:

If equipped, this feature adjusts the volume based on the noise in the vehicle. See *AM-FM Radio* on page 11.

## SiriusXM Travel Link (If Equipped)

SiriusXM Travel Link is available on the navigation system through a service fee subscription.

From the Home Page, press WEATHER. The system displays the current weather page.

### Current Condition

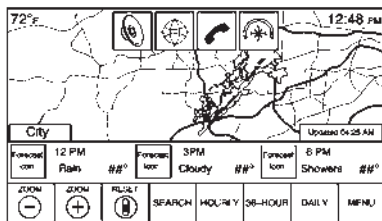

The current weather page displays:

- Doppler Map with Weather
- Forecast Information
- Interaction Selector
- Status

- Time of Map Update
- Applications Tray

Allow approximately 15 minutes for the current weather in the area to display.

## Weather Regions

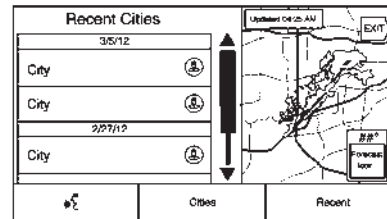

When in the weather application, press the SEARCH icon to display a split map. The list displayed on the left of the split map allows changes to the location.

The Doppler map and forecast information display a preview of the map for the location selected. The forecast information is for the current weather or next available forecast data.

## 18 Infotainment System

Press the EXIT screen button to return to the main weather map.

Press one of the options displayed on the Interaction Selector along the bottom of the map screen to select another function or display another type of list.

### Weather Screen Not Under Guidance

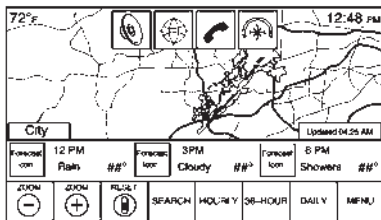

The weather application uses the navigation system to provide the appropriate information for the guidance route. When not under guidance, it defaults to the current location.

**Doppler Map:** The Doppler map is shown with the vehicle location in the center of the map.

**City and State:** The city and state are displayed for the view currently shown. The default is the current city and state that the vehicle is in.

### Forecast Information

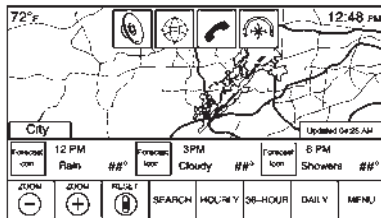

- The map can be panned to another location. The forecast information is updated to the new location.
- The city and state update to reflect the current location.
- Press the RESET screen button to reset the map back to the current vehicle location.

### Weather Menu

Press MENU on the Weather Interaction Selector along the bottom of the map screen to display the Weather Menu.

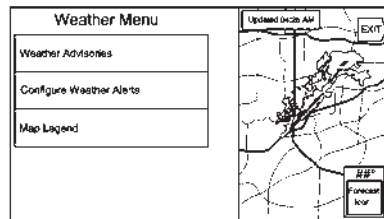

The options are:

- **Weather Advisories:** Any weather advisories that are in effect for the local area or while on route are displayed in a list. Press on an advisory from the list to display a screen that gives additional details about the advisory and shows the advisory location on the map.

- **Configure Weather Alerts:** Press to access the Weather Alerts menu. Press the Weather Alerts line item to turn the alerts On or Off. Press to select any one of the other line items such as High, Low, or Informational to filter the selected alerts for display, while the others will be suppressed.
- **Map Legend:** Press to display the Map Legend.

**Interaction Selector**

The Interaction Selector at the bottom of the screen can be used to switch between different views within the weather screen.

These buttons are:

- **ZOOM – or ZOOM +:** Press to zoom the map in or out.
- **RESET:** Press to reset the map back to its original location.

- **SEARCH:** Press to search for a new weather map location. The last destination screen displays. Press any button along the bottom of the Interaction Selector to help find a different destination. These are , Cities, and Recent.

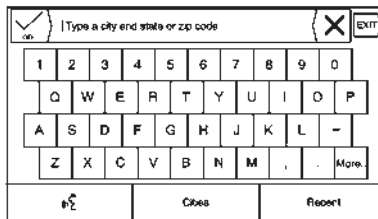

Press Recent to display a list of recent locations that were recently viewed for weather.

Press  to activate voice recognition. State a city and state or ZIP code. Follow the voice prompts to find the desired destination.

Press Cities to enter a city and state or ZIP code.

Type a city or state name on the keyboard screen to find the weather. If the state is omitted, the system assumes a city is being searched for within the current state. If the ZIP code is typed, the system displays the city associated with that ZIP code.

- If one match results from a weather search, the system returns to the map. The map and forecast information updates for that location.
- If there are multiple results from the weather search, a list of possible matches displays. The map shows the first match in the list along with the current weather information in the lower right corner.

- **HOURLY:** Press to display the hourly forecast for the current vehicle location. A forecast icon is shown for each period available.
- **36-HOUR:** Press to display the current weather, six-hour forecast, and tomorrow's weather. A forecast icon is shown for each period available.
- **DAILY:** Press to display a daily forecast for the next five days. A forecast icon is shown for each period available.
- **MENU:** Press to display the current advisories, turn weather alerts on or off, and view the map legend.
- **ON ROUTE:** Press to display the forecasted weather for the route. This feature is only available while under route guidance.

### SiriusXM NavTraffic (If Equipped)

The infotainment system may have SiriusXM NavTraffic®. It is a subscription service provided through SiriusXM Satellite Radio. A service fee is required to receive the SiriusXM NavTraffic service.

Detailed traffic information is delivered to the vehicle's navigation system by the SiriusXM Radio satellites. SiriusXM NavTraffic provides continuously updated traffic information.

The service may be available in more cities in the future. See [www.siriusxmnavtraffic.com](http://www.siriusxmnavtraffic.com) for more details on local coverage.

To access the traffic features, press the Traffic screen button on the Map Menu.

If traffic is not available because there is no valid SiriusXM subscription, a pop-up displays information on how to reactivate the subscription and SiriusXM radio ID.

### Traffic Alert While Under Guidance

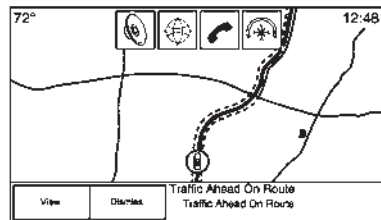

If data is received about a traffic development on the route ahead, a search for a better route is performed. If a better route is found, information may be displayed in an alert. This alert displays the route information and how much time may be saved. If the alternative route is accepted, the current route will be altered.

If the alert is not acknowledged, the alert automatically times out and does not modify the route.

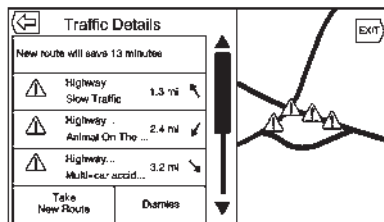

The detail view of the incident shows any data about the incident as well as how much time could be saved by avoiding it. The map view shows the incident, the original route, and the suggested route. If voice prompts are enabled, the incident information is spoken. Press the Take New Route screen button to change to the new route.

### Traffic Alert While Not Under Guidance

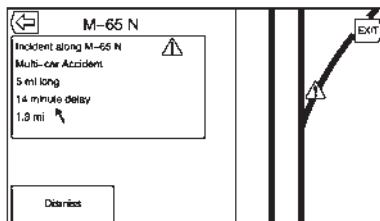

While driving and not under guidance, the system can receive data indicating an accident or slow traffic flow. The information about the incident or slow traffic is displayed as an alert when the incident is 5 km (3 mi) ahead. The incident can be viewed on the map. Press the Dismiss screen button to return to the previous map.

### SiriusXM Travel Link Movie Listings

A movie theater POI can be searched through a POI search or browsed through the POI category

structure. When the details for a movie theater are shown, there is additional information about the theater. When SiriusXM Travel Link Movie Listings information is available for the selected theater, this detailed information is shown in the additional details area of the display.

The details shown depend on the source of the information.

Details shown include:

- Movie Names
- Parental Ratings (G, PG-13, R, etc.)
- Showtimes
- Runtime

### SiriusXM Travel Link Fuel Pricing (If Equipped)

When SiriusXM Travel Link Fuel Pricing information is available for a particular fuel station, the price displays for regular unleaded or diesel fuel, depending on the fuel type configured in the system.

This fuel station POI can either be searched for through a POI search, or browsed through the POI category structure.

- Press the Sort button to change the sort method. The default sort method is based on distance, with the closest fuel stations at the top of the list.
- Press the Sort button to cycle through the sorting options of distance, price, or name. The last viewed sorting method is displayed and is retained over ignition cycles.

If the sorting method of price has been selected, the fuel stations in the list will appear from the lowest to the highest price based on the fuel type selected. For gasoline, the price shown is for regular unleaded. When diesel is selected as the fuel type, the diesel price is shown.

### Radio Reception

Unplug electronic devices from the accessory power outlets if there is interference or static in the radio.

#### FM

FM signals only reach about 16 to 65 km (10 to 40 mi). Although the radio has a built-in electronic circuit that automatically works to reduce interference, some static can occur, especially around tall buildings or hills, causing the sound to fade in and out.

#### AM

The range for most AM stations is greater than for FM, especially at night. The longer range can cause station frequencies to interfere with each other. Static can also occur when things like storms and power lines interfere with radio reception. When this happens, try reducing the treble on the radio.

### SiriusXM Satellite Radio Service

If equipped, SiriusXM Satellite Radio Service provides digital radio reception. Tall buildings or hills can interfere with satellite radio signals, causing the sound to fade in and out. In addition, traveling or standing under heavy foliage, bridges, garages, or tunnels may cause loss of the SiriusXM signal for a period of time.

### Cell Phone Usage

Cell phone usage, such as making or receiving phone calls, charging, or just having the phone on may cause static interference in the radio. Unplug the phone or turn it off if this happens.

### Backglass Antenna

The AM-FM antenna is integrated with the rear window defogger in the rear window. Do not scratch the inside surface or damage the lines in the glass. If the inside surface is

damaged, it could interfere with radio reception. For proper radio reception, the antenna connector needs to be properly attached to the post on the glass.

If attaching a cell phone antenna to the glass, attach it between the grid lines.

 **Caution**

Using a razor blade or sharp object to clear the inside rear window can damage the rear window antenna and/or the rear window defogger. Repairs would not be covered by the vehicle warranty. Do not clear the inside rear window with sharp objects.



 **Caution**

Do not apply aftermarket glass tinting with metallic film. The metallic film in some tinting materials will interfere with or distort the incoming radio reception. Any damage caused to the backglass antenna due to metallic tinting materials will not be covered by the vehicle warranty.

### Multi-Band Antenna

The roof antenna is for OnStar, SiriusXM Satellite Radio (U.S. and Canada only), and GPS (Global Positioning System). Keep clear of obstructions for clear reception. If the vehicle has a sunroof, and it is open, reception can also be affected.

### Pandora Internet Radio

If equipped, Pandora® is a free Internet radio service that streams personalized radio stations based on artists, tracks, genres, and comedians. Create stations using the Pandora website or Smartphone application, then use  (thumbs up) or  (thumbs down) to personalize stations. To set up an account, or for more information, go to [www.pandora.com](http://www.pandora.com).

A phone or tablet with an Internet connection and the Pandora application installed is required. Personal cell phone data plans are used. Make sure the latest version is installed on the device.

### Launching Pandora

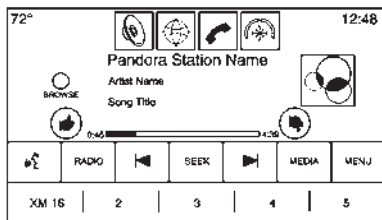

Connect the iPhone to the USB port, or connect Android™ or BlackBerry® through Bluetooth. See *Bluetooth (Overview) on page 108* or *Bluetooth (Infotainment Controls) on page 109* or *Bluetooth (Voice Recognition) on page 113*. For first time use, set up the stations before connecting to the vehicle.

#### Using the iPhone

1. Plug the device into the USB port. The phone screen must be unlocked.

2. Launch Pandora directly from the Home Page by pressing the Pandora icon.

If nothing happens when the available Pandora screen button is pressed, download the latest Pandora application and retry.

The login screen may display on the device.

#### Using an Android or BlackBerry Phone

The Android or BlackBerry phone must be unlocked to launch Pandora service.

1. Pair the phone using Bluetooth.
2. Press Pandora on the Home Page to launch the service.
3. If nothing happens when the available Pandora screen button is pressed, download the latest Pandora application and retry.

The login screen may display on the device.

### Pandora Menus

Press Menu on the Pandora main page.

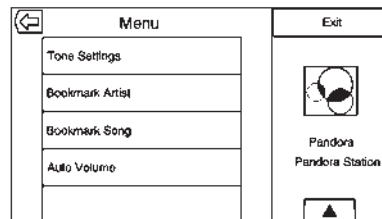

Pandora has a menu system with the following:

**Tone Settings:** Press to adjust the tone settings. See *AM-FM Radio on page 11*.

**Bookmark Artist:** Press to bookmark the artist.

**Bookmark Song:** Press to bookmark the song.

**Auto Volume:** This feature sets the auto volume based on the speed of the vehicle and noise in the vehicle. See *AM-FM Radio on page 11*.



**Bose AudioPilot:** If equipped, this feature adjusts the volume based on the noise in the vehicle. See *AM-FM Radio* on page 11.

## Pandora Features

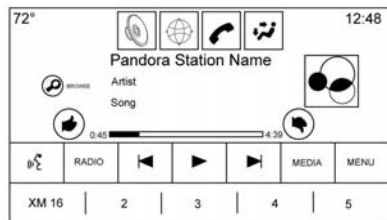

Pandora service has features to rate tracks, skip tracks, or change stations.

**👎 (Thumbs Down):** When pressed, Pandora stores this information, changes to the next track, and does not play this track on this station again. This helps Pandora choose which tracks should not play on this station. This feature is only available on user created stations.

**👍 (Thumbs Up):** When pressed, Pandora stores this information and 👍 is highlighted for the remainder of the track. This helps Pandora choose which tracks should play on this station.

**▶ (Next Track):** When pressed, Pandora changes to the next track.

**▶ or || (Play/Pause):** Press to play or pause playback.

### Pandora Skip Limit

Pandora limits the number of skips allowed on their service. When the skip limit is reached, 👎 or ▶ will not skip the currently playing track, but the 👎 feedback will be recorded.

### Advertisements on Pandora

Pandora may display advertisements. The artist name and track title will not be displayed and the skip track button will not be available.

## Pandora Troubleshooting

### Unable to Connect Device to Vehicle

If the device is unable to connect through the USB or Bluetooth:

1. Turn the vehicle off.
2. Take the Remote Keyless Entry (RKE) transmitter at least 6 m (20 ft) away from the vehicle.
3. Wait about 30 seconds, and try to connect the device again. See *Bluetooth (Overview)* on page 108 or *Bluetooth (Infotainment Controls)* on page 109 or *Bluetooth (Voice Recognition)* on page 113.



### Unable to Start Pandora

If the device is unable to launch Pandora:

- Check that the latest version of Pandora is installed.
- Check that there is an active account logged into Pandora.

- Have at least one station created.
- For Android and BlackBerry devices, check that the device is paired with the vehicle, and whether the device displays in the Connected phone sources list under the Phone icon from the Home Page.
- For an iPhone, check that the USB cable is connected to the USB port and the screen is unlocked.
- Close Pandora on the device and launch again. Devices that allow multitasking may require an extra step to quit the Pandora application. See the cell phone manufacturer's user guide.

### Thumbs Up or Thumbs Down Error

If there is an error trying to rate a track with the  or  buttons, the message "Thumbs Down Error" or "Thumbs Up Error" will display. Press OK to dismiss.

### Loss of Audio

Loss of Pandora audio can happen in different ways:

- Weak or lost data connection.
- Device needs to be charged.
- Application needs to be relaunched.
- Connection between phone and radio was lost.
- An iPhone is connected to both Bluetooth and the USB port.

If there is a loss of audio, playback can be resumed by changing the audio flow from Bluetooth to USB cable.

To change the audio flow:

1. While the iPhone is connected, double tap the phone's home button.
2. Swipe a finger to the left on the phone's screen display. A box with a triangle displays on the lower line of the box that is

highlighted. Press this box to display the dock connector option.

3. Select Dock Connector.

### Common Pandora Messages

#### Pandora Error/Please Check Device:

Not signed in or Pandora is down for maintenance.

**No Stations Available:** No stations are available on the Pandora server through the connected device.

**No Internet Connection:** A few reasons for loss of Internet connection are:

- The connected device loses its cellular connection.
- The device does not support Internet connectivity.
- The device is not in the vehicle.

**No Bluetooth Signal:** The Bluetooth signal is lost.

## Audio Players

### CD Player

If equipped, the player can be used for CD and MP3 audio.

The system is capable of playing:

- Most audio CDs
- CD-R
- CD-RW
- MP3 or unprotected WMA formats

When playing any compatible recordable disc, the sound quality can be reduced due to disc quality, the method of recording, the quality of the music that has been recorded, or the way the disc has been handled.

There can be increased skipping, difficulty in finding tracks, and/or difficulty in loading and ejecting. If these problems occur, check the disc for damage or try a known good disc.

To avoid damage to the CD player:

- Do not use scratched or damaged discs.
- Do not apply labels to discs. The labels could get caught in the player.
- Insert only one disc at a time.
- Keep the loading slot free of foreign materials, liquids, and debris.
- Use a marking pen to label the top of the disc.

### Loading and Ejecting Discs

To load a disc:

1. Turn the vehicle on.
2. Insert a disc into the slot, label side up. The player pulls it in the rest of the way. If the disc is damaged or improperly loaded, there is an error and the disc ejects.

Press  to eject a disc from the CD player. If the disc is not removed within a short period of time, it is automatically pulled back into the player.

### Playing an Audio MP3 or CD

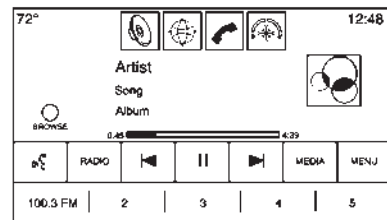

Press the MEDIA screen button until CD Audio icon Now Playing view is selected.

On the CD main page, a track number displays at the beginning of each track, or Song, Artist, and Album information displays when available.

Use the following controls to play the disc:

### ◀ (Previous/Fast Reverse):

- Press to seek to the beginning of the current or previous track. If the track has been playing for less than 10 seconds, it seeks to the previous track. If longer than five seconds, the current track starts from the beginning.
- Press and hold to fast reverse through a track. Release the button to return to playing speed. Elapsed time displays.

### ▶ (Next/Fast Forward):

- Press to seek to the next track.
- Press and hold to fast forward through a track. Release the button to return to playing speed. Elapsed time displays.

When a Blu-ray® or DVD disc, if equipped, is loaded and the CD button is pressed, a message displays. Go to video application to play DVD/BD.

### Error Messages

If Disc Error displays and/or the disc comes out, it could be for one of the following reasons:

- The disc has an invalid or unknown format.
- The road is very rough. Try the disc again when the road is smoother.
- The disc is dirty, scratched, wet, or upside down.
- The air is very humid. Try the disc again later.
- There was a problem while burning the disc.
- The label is caught in the CD player.

If Disc Player Error displays, it could be for one of the following reasons:

- The player temperature is too high.
- There are load or eject errors.

If the CD is not playing correctly, for any other reason, try a known good CD.

If any error continues, contact your dealer.

### MP3/CD Menu

Press the MENU button while that source is active to access the menu.

Press any of the following buttons on the MP3/CD Menu:

**Shuffle:** Press to play the tracks randomly. Press again to stop shuffle.

**Auto Volume:** If equipped, this feature adjusts the volume based on the speed of the vehicle. See *AM-FM Radio on page 11*.

**Tone Settings:** Press + or – to adjust Bass, Midrange, Treble, or Surround. See *AM-FM Radio on page 11*.

### MP3 Guidelines

- Sampling rate: 16 kHz, 22.05 kHz, 24 kHz, 32 kHz, 44.1 kHz, and 48 kHz.
- Bit rates supported: 8, 16, 24, 32, 40, 48, 56, 64, 80, 96, 112, 128, 144, 160, 192, 224, 256, and 320 kbps.
- Recorded on a CD-R or CD-RW.

### MP3 Folder Information

Press anywhere between the top applications tray or the bottom menu to display the browse screen.

**Root Directory:** To access, press the screen anywhere in the central area of the screen. The root directory is treated as a folder. All files contained directly under the root directory are accessed prior to any root directory folders.

**No Folder:** When the CD only contains compressed audio files without any folders or playlists, all files are under the root folder.

**File System and Naming:** The song titles, artists, albums, and genres are taken from the file's ID3 tag and are only displayed if present in the tag. If a song title is not present in the ID3 tag, the radio displays the file name as the track name.

### USB/SD Port

Audio from videos stored on SD/USB cards may be listened to while the vehicle is in a forward gear. Videos can be watched while the vehicle is in P (Park). Use play/pause or next/previous to control the video or press the browse screen to display a list of the current video filters.

This vehicle may have two SD card readers and three USB ports: one SD card reader and one USB port in the center console, one USB port in the storage behind the climate control system, and if equipped with Rear Seat Entertainment (RSE),

there may be one SD card reader and one USB port in the rear media console storage area.

### Playing from a USB

A USB mass storage device can be connected to the USB port.

Audio extensions supported by the USB are:

- MP3
- WMA
- AAC
- OGG
- AIFF
- 3GPP

### Gracenote®

When plugging in a USB device, Gracenote service builds voice tags for music. Voice tags allow artists, albums with hard to pronounce names, and nicknames to be used to play music through voice recognition.

While indexing, infotainment features are available.

### My Media Library

My Media is only available when more than one indexed device is connected. It allows access to content from all indexed media sources. Press the MEDIA screen button to scroll through the options until My Media is selected. Press anywhere in the central area of the screen to browse the content.

### USB MP3 Player and USB Drives

The USB MP3 players and USB drives connected must comply with the USB Mass Storage Class specification (USB MSC).

To play a USB device:

1. Connect the USB.
2. Press MEDIA until the connected device is shown.

Use the following when playing an active USB source:

▶ **(Play):** Press to play the current media source.

|| **(Pause):** Press to pause play of the current media source.

◀ **(Previous/Reverse):**

- Press to seek to the beginning of the current or previous track. If the track has been playing for less than five seconds, the previous track plays. If playing longer than five seconds, the current track restarts.
- Press and hold to reverse quickly through playback. Release to return to playing speed. Elapsed time displays.

▶ **(Next/Fast Forward):**

- Press to seek to the next track.
- Press and hold to advance quickly through playback. Release to return to playing speed. Elapsed time displays.

### USB Menu

Press Menu to display the USB menu. The following may be available:

**Shuffle:** Press to play the tracks randomly. Press again to stop shuffle.

**Bose AudioPilot:** If equipped, press to turn Bose AudioPilot on or off. AudioPilot is an On/Off selection on the list entry from the Main menu. See *AM-FM Radio on page 11*.

**Tone Settings:** Press + or – to adjust Bass, Midrange, Treble, or Surround. See *AM-FM Radio on page 11*.

**USB Browse Menu**

Press the browse screen button to view the browse menu and the following options are displayed along the bottom of the screen:

**Playlists:**

Supported Playlist extensions are: m3u, pls, wpl, asx, b4s, and xspf.

1. Press to view the playlists stored on the USB.
2. Select a playlist to view the list of all songs in that playlist.
3. Select a song from the list to begin playback.

**Artists:**

1. Press to view the list of artists stored on the USB.
2. Select an artist name to view a list of all albums by the artist.
3. To select a song, press All Songs or press an album and then select a song from the list.

**Albums:**

1. Press to view the albums on the USB.
2. Select the album to view a list of all songs on the album.
3. Select a song from the list to begin playback.

**Songs:**

1. Press to display a list of all songs on the USB.
2. To begin playback, select a song from the list.

**Genres:**

1. Press to view the genres on the USB.
2. Select a genre to view a list of artists.
3. Select an artist to view albums by that artist.
4. Select an album to view songs on the album.
5. Select a song to start playback.

Podcasts, Composers, Audiobooks, Videos, and Folder View are shown when More is selected from the bottom of the screen.

**Podcasts:**

1. Press to view the podcasts on the USB.
2. Select Podcast to get a list of podcast episodes.

**Composers:**

1. Press to view the composers on the USB.
2. Select Composer to view a list of albums by that composer. Select an album or all songs to view a list of songs.
3. Select a song from the list to begin playback.

**Audiobooks:**

1. Press to view the audiobooks stored on the device. Select an audiobook to get a list of chapters.

## 32 Infotainment System

---

2. Select the chapter from the list to begin playback.

### Folder View (If Equipped):

1. Press to view the directories on the USB/SD card.
2. Select a folder to view a list of all files.
3. Select a file from the list to begin playback.

### File System and Naming

File systems supported by the USB are:

- FAT32
- NTFS
- HFS+

The songs, artists, albums, and genres are taken from the file's song information and are only displayed if present. The radio displays the file name as the track name if the song information is not available.

### Supported Apple® Devices

The following Apple devices are supported:

- iPod touch® (5th generation)
- iPod touch (4th generation)
- iPod touch (3rd generation)
- iPod touch (2nd generation)
- iPod touch (1st generation)
- iPod nano® (7th generation)
- iPod nano (6th generation)
- iPod nano (5th generation)
- iPod nano (4th generation)
- iPod nano (3rd generation)
- iPod nano (2nd generation)
- iPod nano (1st generation)
- iPod classic®
- iPod® with video
- iPhone® 5
- iPhone 4S
- iPhone 4G

- iPhone 3GS
- iPhone 3G
- iPhone
- iPad®

### Loss of Audio

Do not play music through Bluetooth of an iPhone that is connected by USB. If an attempt to pair the Bluetooth of the same connected phone is made, the system will automatically mute the iPhone audio.

If there is a loss of audio, playback can be resumed by changing the audio flow from Bluetooth to USB cable.

To change the audio flow:

1. While the iPhone is connected, double tap the phone's home button.
2. Swipe a finger to the left on the phone's screen display. A box with a triangle displays on the lower line of the box that is



highlighted. Press this box to display the dock connector option.

### 3. Select Dock Connector.

Other phones such as the Android phones may have a similar reaction.

## Storing and Recalling Media Favorites

To store media favorites, press and hold an open favorite during media playback to display a list of media types. Select from this list.

The media types that may display are:

**Genres:** Press to store the current genre as a favorite. Press a screen button in the favorite area to recall a favorite genre. The first song of the genre begins to play.

**Artists:** Press to store the current artist as a favorite. Press a screen button in the favorite area to recall a favorite artist. The first song in the artist list begins to play.

**Albums:** Press to store the current album as a favorite. Press a screen button in the favorite area to recall a favorite album. The first song in the album list begins to play.

**Playlists:** Press to store the current playlist as a favorite. Press a screen button in the favorite area to recall a favorite playlist. The first song in the playlist begins to play.

**Songs:** Press to store the current song as a favorite. Press a screen button in the favorite area to recall a favorite song.

**Podcasts or Podcast Episode:** Press and hold a screen button to store the current podcast as a favorite. Press a screen button in the favorite area to recall a favorite podcast or podcast episode. The podcast or podcast episode begins to play.

**Audiobooks:** Press and hold a screen button to save the current audiobook as a favorite. Press a screen button in the favorite area to

recall a favorite audiobook; the first chapter in the audiobook begins to play.

**Videos:** Press and hold a screen button to store the current video as a favorite. Press a screen button in the favorite area to recall a favorite video; the first episode in the video begins to play. Not all formats are supported.

## SD Card Reader

This vehicle may have two SD card readers: one in the center console and one in the rear HVAC area, if equipped with Rear Seat Entertainment (RSE).

The SD card reader is for audio and video playback and uses the same controls as the USB Port. Playback from an SD card follows the same file formats and restrictions defined under *USB/SD Port on page 29*. Not all formats are supported.

Set up the SD card while the vehicle is in P (Park). See "Audio" under *Infotainment on page 3*.

## 34 Infotainment System

---

Place the card into the port.

If an SD card has already been connected, but a different source is currently active, press the MEDIA screen button to scroll through the audio source screens until SD card displays.

### Auxiliary Jack

This vehicle has an auxiliary input jack in the center console under the armrest and in the rear media console if equipped with Rear Seat Entertainment (RSE). Possible auxiliary audio sources include:

- Laptop computer
- Audio music player

This jack is not an audio output. Do not plug headphones into the auxiliary input jack. Set up an auxiliary device while the vehicle is in P (Park).

Connect a 3.5 mm (1/8 in) cable from the auxiliary device to the auxiliary input jack. When a device

is connected, the system can play audio from the device over the vehicle speakers.

If an auxiliary device has already been connected, but a different source is currently active, press the MEDIA screen button to scroll through audio source screens, until AUX Input source screen displays.

### Bluetooth Audio

If equipped, music may be played from a paired Bluetooth device. See *Bluetooth (Overview) on page 108* or *Bluetooth (Infotainment Controls) on page 109* or *Bluetooth (Voice Recognition) on page 113* for help pairing a device.

Volume and song selection may be controlled by using the infotainment controls or on the phone/device. If Bluetooth Audio is selected and no volume is present, check the volume setting on both your phone/device and the infotainment system.

Music can be launched by pressing the MEDIA screen button on the Home Page.

To play music via Bluetooth:

1. Power on the device, and pair to connect the device.
2. Once paired, go into the audio application from the Home Page or via the applications tray. Select MEDIA until Bluetooth displays.

### Bluetooth Audio Menu

Press the MENU screen button to display the Bluetooth Audio menu. The following may be available:

**Bose AudioPilot:** If equipped, press to turn Bose AudioPilot on or off. AudioPilot is an On/Off selection on the list entry from the Main menu. See *AM-FM Radio on page 11*.

**Tone Settings:** Press + or – to adjust Bass, Midrange, Treble, or Surround. See *AM-FM Radio on page 11*.

Press **◀** Back to go back to the previous menu.

**Manage Bluetooth Devices:** Press to go to the Bluetooth page to add or delete devices or to pair.

When selecting Bluetooth audio, the radio may not be able to launch the audio player on the connected device to start playing. When the vehicle is not moving, use the phone to begin playback.

All devices launch audio differently. When selecting Bluetooth audio as a source, the radio may show as paused on the screen. Press play on the device or press **▶** on the screen to begin playback.

Some phones support sending Bluetooth music information to display on the radio. When the radio receives this information, it will check to see if any is available and display it. For more information about supported Bluetooth features, see [www.gm.com/bluetooth](http://www.gm.com/bluetooth).

## OnStar System

OnStar<sup>®</sup> with 4G LTE



If equipped with OnStar 4G LTE, up to seven devices, such as smartphones, tablets, and laptops, can be connected to high-speed Internet through the vehicle's built-in Wi-Fi<sup>®</sup> hotspot.

Call 1-888-4-ONSTAR (1-888-466-7827) to connect to an OnStar Advisor for assistance. See [www.onstar.com](http://www.onstar.com) for a detailed instruction guide, vehicle availability, details, and system limitations. Services and apps vary by make, model, year, carrier, availability, and conditions. 4G LTE service is available in select markets. 4G LTE performance is based on industry averages and vehicle systems design. Some services require a data plan.

## Rear Seat Infotainment

### Rear Seat Entertainment (RSE) System

The vehicle may have an RSE system. If equipped, the RSE system includes Blu-ray/DVD/CD player, USB, SD card reader, audio/video jacks, wired headphone jack, wireless headphones, and remote control.

#### Before Driving

The RSE can only be viewed on the front screen when the vehicle is in P (Park). The driver cannot safely view the video screen while driving.

In severe or extreme weather conditions, the RSE system may not work until the temperature is within the operating range of above  $-20^{\circ}\text{C}$  ( $-4^{\circ}\text{F}$ ) and below  $55^{\circ}\text{C}$  ( $131^{\circ}\text{F}$ ).

#### System Operation

The video screens are on the back of the driver and front passenger seats, or overhead in the second or third row (if equipped).

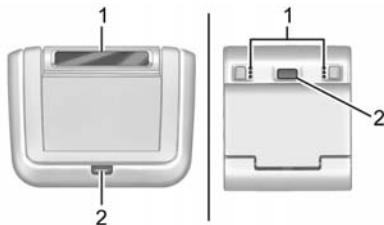

Rear Seat Screens (As Equipped)

1. IR Lens
2. Release Button

To use:

1. Press the release button on the seatback console or in front of the overhead screen. Do not pull on the sides of the screen.



2. Move the screen to the viewing position. The remote must be removed from the storage location to be used.

#### Caution

When storing the remote, place it in the storage area with buttons facing towards you or damage to the screen could occur.

3. Opening a screen will turn the system on. If the screens are open with the system off, press

the power button on the remote to turn the system on. The system can also be turned on from the front infotainment system by pressing the Video icon on the Home Page.

Push the video screen into its locked position when it is not in use. The screen turns off automatically.

The audio may continue with the screens down. This allows listening to music without the screen on. To turn the audio off, press the power button on the remote or on the front infotainment Video page.

### Caution

Avoid directly touching the video screen, as damage may occur.

## Sources

Sources, if equipped, include AM, FM, BD, XM (if equipped), AUX, Photos, CD/DVD/Blu-ray, USB, and SD card.

## Menus and Features

### AM/FM Menu

Press the RADIO button on the remote, then select AM or FM.

Access the AM or FM menu by pressing any menu button in any AM or FM screen.

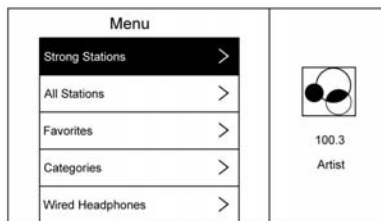

Use this menu to select Strong Stations, All Stations, Favorites, Categories, Wired Headphones, DivX<sup>®</sup> VOD, or Software Information.

Only one tuner source may be active at a time.

### XM Menu

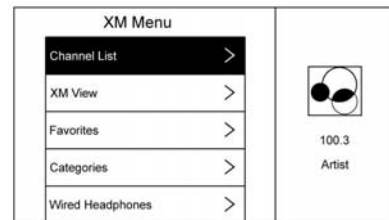

Press the RADIO button on the remote control and then select XM (if equipped) by pressing ENTER on the remote. Access the XM Menu by pressing the Menu button in any XM screen. This menu is used to select Channel List, XM View, Favorites, Categories, Wired Headphones, DivX VOD, or Software Information.

Only one tuner source may be active at same time.

## 38 Infotainment System

### Disc Menu BD

Press MEDIA on the remote control and then select CD/DVD/BD, USB, SD, AUX, or Photo Viewer.

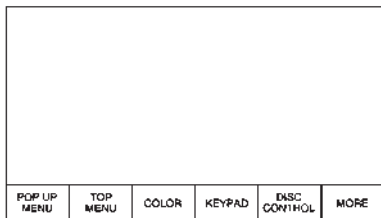

Press MENU on the remote control once to display menus based on the media.

Choose from POP UP MENU (BD Only), TOP MENU, COLOR, KEYPAD, DISC CONTROL, and MORE (SETTINGS, PREVIOUS, NEXT, STILLS OFF).

To close, press the MENU button or  (Back) button, or wait for the time out.

### Disc Menu DVD

Press MENU on the remote control once to select from TOP MENU, KEYPAD, STOP DISC, PHOTO, and SETTINGS.

To close, press MENU or  (Back), or wait for the time out.

### CD Menu

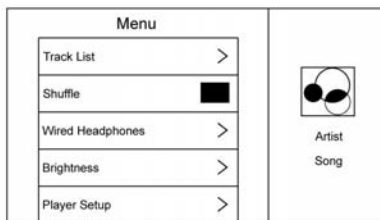

Select from:

- Track List
- Shuffle
- Disc Information (if available)
- Wired Headphones
- Brightness

- Player Setup: Audio Compression, Auto Enter (if available)
- DivX VOD
- Title Search (if available)
- Software Information

### Pop Up Menu (BD Only)

Select POP UP MENU from the menu options to display the disc menu on top of the movie. Make a selection to exit the Pop-up menu. When the Pop-up menu is opened, the overlay/Interaction Selector menu will be closed. The Pop-up menu is disc dependent and may or may not time out on its own.

### Top Menu BD/DVD

Select this item to display the menu for the DVD or BD. Make a selection to exit the TOP MENU. TOP MENU is not available for BDAV, DVD-VR, and AVC-REC.

## Color (BD Only)

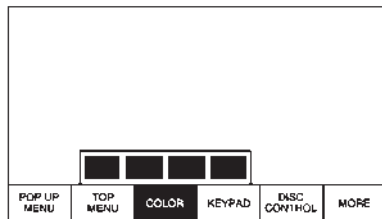

Select COLOR to display the four color button options: blue, yellow, red, and green. Highlight a color option and press ENTER and the appropriate action will be carried out. Press the Back button or MENU button, or wait for the 15-second time out to close the menu. Press the down arrow on the yellow color to keep the overlay menu up, but close the color menu. The color menu is disc dependent; selecting colors for discs that do not support this feature will have no function.

## Keypad BD/DVD

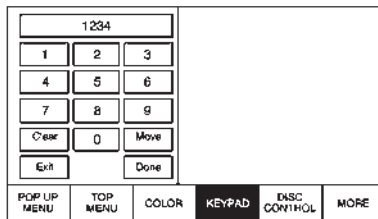

Press KEYPAD to display the single digit entry keypad. To close the keypad, press the Back button or MENU button, wait for the menu to time out, or press the down arrow to keep the menu up but close the keypad. The keypad is disc dependent; selecting numbers for discs that do not support this feature will have no function.

The keypad input is limited to four digits. Any digits entered beyond four will be discarded.

Press the Clear button to clear one digit at a time. Press and hold the Clear button to clear all entered digits.

## Disc Control (BDAV and BDMV Only)

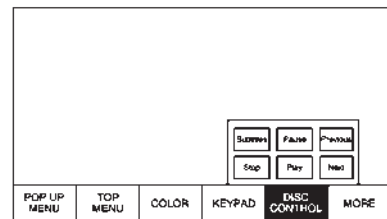

Press DISC CONTROL to display options for subtitles, play, pause, track forward, track previous, and stop the disc. Press the Back button or MENU button, or wait for the time out to close the menu. Press the down arrow from Stop, Play, or Next to keep the overlay menu up, but close the disc control menu. The disc control menu is disc

dependent; selecting controls for discs that do not support this feature will have no function.

### Stop Disc (DVD Only)

Press Stop to close the overlay menu and open the Disc Stopped screen. Press Menu on the screen to open the Disc Stopped menu. Select from Resume Playback, Top Menu, Title Search, Restart Disc, Browse Media, and Player Setup. Some of these options are not available while the disc is playing.

**Resume Playback:** Returns to the current position on the disc and resumes play.

**Top Menu:** Returns to the disc provided menu.

**Title Search (BDMV, AVCHD, and DVD-V only):** Provides a keypad.

**Browse Media (BD-DAV, DVD-A, DVD-VR, AVCREC only):** Allows the media on the disc to be searched in a list format.

**Restart Disc:** Allows the disc to restart from the beginning.

### More BD/DVD

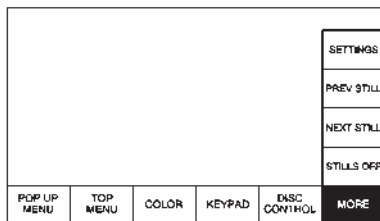

The MORE submenu includes both the SETTINGS item and items related to still pictures.

### Prev Still/Next Still/Stills Off

This feature allows for turning stills off, going to the previous still, or advancing to the next still picture. PREV STILL will go back to the previous picture. NEXT STILL will advance to the next picture in sequential order. STILLS OFF will return to the designated home still, if it is available. Press the Back

button or MENU button, or wait for the 15-second time out to close the menu. Press the down arrow on the bottom option to close the next still pop-up. The menu will remain up. This feature is disc dependent.

This feature can also be accessed from the Photo button on the DVD Disc Menu depending on the disc.

### Settings BD/DVD

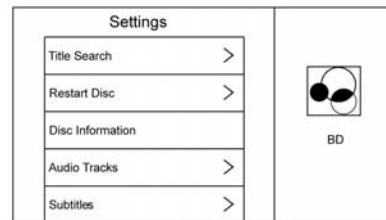

Select to access:

- **Browse Media (BD-DAV, AVCREC, DVD-A, DVD-VR Only):** Allows browsing by Video List or Playlist.



- Title Search (AVCHD, DVD-V, BDMV Only): This allows the titles provided by the disc to be searched. Select this option to bring up a keypad to search for specific titles.
- Restart Disc: Restarts the disc from the beginning.
- Disc Information (if available)
- Audio Tracks
- Subtitles
- Angle (BDMV, DVD-V, DVD-A Only): Select an angle by using the up and down arrows to highlight the option, and then press ENTER or the right arrow.
- Screen Mode: Use Screen Mode to adjust the framing on the RSE display. Select Normal, Wide, or Zoom. Screen Mode only applies to video sources and should be maintained if the disc is ejected.

- Wired Headphones: Use Wired Headphones to listen to audio on the wired headphones. The headphone audio plays depending on which screen is selected. The default is screen 1 audio.
- Brightness: Increase the brightness by using the up or right arrow and decrease the brightness by using the down or left arrow. Each screen brightness can be adjusted separately.
- Player Setup: See "Player Setup" later in this section.
- DivX VOD
- Software Information

### Player Setup BD/DVD

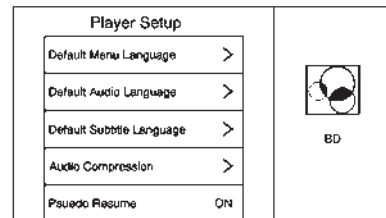

Player Setup may include:

- Default Menu Language: With no disc inserted, select from a list of languages or enter a language code.
- Default Audio Language: With no disc inserted, select from a list of languages or enter a language code.
- Default Subtitle Language: With no disc inserted, select from a list of languages or enter a language code.

## 42 Infotainment System

- **Audio Compression:** When on, the RSE will attempt to reduce the difference between the audio highs and lows.
- **Pseudo Resume:** When on, the RSE will attempt to resume play of the video where it left off. This can be turned on or off.
- **Auto Enter:** When on, the RSE will attempt to start play of the video when the disc is inserted. This feature can be turned on or off. Not all discs support this feature.
- **Audio Channel (AVCREC, DBAV, DVD-VR Only)** contains: Stereo, Left Mono, and Right Mono. Audio Channel is available from the Settings menu. Default will be determined by the disc.
- **Format Internal User Memory:** Only shown when no disc is inserted.

### Enter Language Code

Enter the desired language code.

Language/Code		User Code
Japanese	JPN	7465
English	ENG	6978
French	FRA	7082
German	DEU	6869
Italian	ITA	7384
Spanish	SPA	6983
Dutch	NLD	7876
Russian	RUS	8285
Chinese	ZHO	9072
Korean	KOR	7579
Greek	ELL	6976
Afar	AAR	6565
Abkhazian	ABK	6566
Afrikaans	AFR	6570
Amharic	AMH	6577
Arabic	ARA	6582

Assamase	ASM	6583
Aymara	AYM	6589
Azerbaijani	AZE	6590
Bashkir	BAK	6665
Byelorussian	BEL	6669
Bulgarian	BUL	6671
Bihari	BIH	6672
Bislama	BIS	6673
Bengali	BEN	6678
Tibetan	BOD	6679
Breton	BRE	6682
Catalan	CAT	6765
Corsican	COS	6779
Czech	CES	6783
Welsh	CYM	6789
Danish	DAN	6865
Bhutani	DZO	6890
Esperanto	EPO	6979
Estonian	EST	6984

Basque	EUS	6985
Persian	FAS	7065
Finnish	FIN	7073
Fiji	FIJ	7074
Faroese	FAO	7079
Friesian	FRY	7089
Irish	GLE	7165
Scots-Gaelic	GLA	7168
Galician	GLG	7176
Guarani	GRN	7178
Gujarati	GUJ	7185
Hausa	HAU	7265
Hindi	HIN	7273
Croatian	HRV	7282
Hungarian	HUN	7285
Armenian	HYE	7289
Interlingua	INA	7365
Interlingue	ILE	7369
Inupiak	IPK	7375

Indonesian	IND	7368
Icelandic	ISL	7383
Hebrew	HEB	7269
Yiddish	YID	8973
Javanese	JAV	7487
Georgian	KAT	7565
Kazakh	KAZ	7575
Greenlandic	KAL	7576
Cambodian	KHM	7577
Kannada	KAN	7578
Kashmiri	KAS	7583
Kurdish	KUR	7585
Kirghiz	KIR	7589
Latin	LAT	7665
Lingala	LIN	7678
Laothian	LAO	7679
Lithuanian	LIT	7684
Latvian	LAV	7686
Malagasy	MLG	7771

Maori	MRI	7773
Macedonian	MKD	7775
Malayalam	MAL	7776
Mongolian	MON	7778
Moldavian	MOL	7779
Marathi	MAR	7782
Malay	MSA	7783
Maltese	MLT	7784
Burmese	MYA	7789
Nauru	NAU	7865
Nepali	NEP	7869
Norwegian	NOR	7879
Occtian	OCI	7967
Oromo	ORM	7977
Oriya	ORI	7982
Panjabi	PAN	8065
Polish	POL	8076
Pashto, Pushto	PUS	8083
Portuguese	POR	8084

Quechua	QUE	8185
Rhaeto-Romance	ROH	8277
Kirundi	RUN	8278
Romanian	RON	8279
Kinyarwanda	KIN	8287
SanSkrit	SAN	8365
Sindhi	SND	8368
Sangho	SAG	8371
Serbo-Croatian	SCR	8372
Singhalese	SIN	8373
Slovak	SLK	8375
Uzbek	UZB	8590
Vietnamese	VIE	8673
Volapuk	VOL	8679
Wolof	WOL	8779
Xhosa	XHO	8872
Yoruba	YOR	8979
Zulu	ZUL	9085
Slovenian	SLV	8376

Samoan	SMO	8377
Shona	SNA	8378
Somali	SOM	8379
Albanian	SQI	8381
Serbian	SRP	8382
Siswairi	SSW	8383
Sesotho	SOT	8384
Sundanese	SUN	8385
Swedish	SWE	8386
Swahili	SWA	8387
Tamil	TAM	8465
Telugu	TEL	8469
Tajik	TGK	8471
Thai	THA	8472
Tigrinya	TIR	8473
Turkmen	TUK	8475
Tagalog	TGL	8476
Setswana	TSN	8478
Tonga	TON	8479

Turkish	TUR	8482
Tsonga	TSO	8483
Tatar	TAT	8484
Twi	TWI	8487
Ukrainian	UKR	8575
Urdu	URD	8582

### Errors

Errors can occur if the local storage area has been broken or if the ignition is turned off during formatting. If the screen is closed during formatting, this will not interrupt the formatting. If the screen is opened again, the current state of format will be displayed. If an error occurs, the Error screen will display when the ignition is turned on.

### Wired Headphones

To select the headphone audio for the wired headphone jack based on screen 1 or screen 2, press ENTER

or the right arrow on the remote. Press the Back button to exit the menu.

The headphones are linked to screen 1 by default.

### **Player Setup (CD-DA Only)**

This allows access to Audio Compression and Auto Enter.

### **Title Search (CD-DA Only)**

This displays a keypad. Press Stop to close the overlay menu and open the Disc Stopped screen. Press Menu on the screen to open the Disc Stopped menu. Select Title Search.

### **Disc Information (CD-DA Only)**

If the inserted disc is a BDMV, BDAV, AVCHD, AVCREC, DVD-Video, or DVD-VR, the disc title should display. If the inserted disc is DVD-Audio, DTS-CD, CDDA, or Mixed-CD, the track number will display.

### **DivX®**

This indicates the vehicle is registered to play DivX media and states how to obtain more information.

### **Software Information**

This allows access to Version Information, Save Vehicle Info to USB, and View Open Source.

Save Vehicle Info to USB allows the current version to be saved to a jump drive, which must be done before an update can be performed.

View Open Source indicates where software information can be found.

### **Changing Between SCREEN 1 and SCREEN 2**

For single overhead screen systems only:

Although two audio sources can be listened to at one time, only one video source can be viewed on the overhead screen at a time.

Press the SCREEN 1 or SCREEN 2 button on the remote control to change between which source will display on the overhead screen.

When SCREEN 1 is being displayed and the SCREEN 2 button on the remote is pressed, the source for SCREEN 2 will be displayed. The audio for SCREEN 1 is available on channel 1 of the headphones and the audio for SCREEN 2 is available on channel 2 of the headphones. Change the channel on the headphones to the desired screen source.

One user can listen to the audio from SCREEN 1 and view the source on the overhead display while another user can listen to a separate audio source by changing the channel on the wireless headphones or setting their wired headphones to SCREEN 2 in the MENU.

### RSE Controls Available from the Front Screen

To access the RSE application, select Video from the HOME screen. The Video app may also be selected from the applications tray if it has been stored in one of the five locations.

### Sourcing to DVD/BD

After a disc is inserted, it will automatically begin playing on both rear screens. If no video disc is inserted or if the disc is ejected while it is sourced to DVD/BD, the screen will display “No Video Disc Inserted.”

With the vehicle in P (Park), BD/DVD can be watched on the front screen. The following icons will appear along the bottom of the front screen when a DVD, VCD, USB, SD, or AUX is inserted:



The following appears when a BD is sourced:



### Rear Media

REAR MEDIA will allow transitioning between Disc, USB, SD, and AUX sources for the rear screens. Sources selected using the REAR

MEDIA button will automatically be sourced for both rear screens and begin playback from the first available file.

The video will only appear on the front screen with the vehicle in P (Park). When the vehicle is in any other gear, the front screen displays the active media source.

### DVD/BD Disc Menu

With the vehicle in P (Park), press to access the DVD/BD disc menu. Make a selection to exit the disc menu.

### Next Track/Previous Track

Use to skip ahead, or to skip back between chapters. Press less than 10 seconds into the current track to start at the beginning of the previous track. Press more than five seconds into the current track to start at the beginning of the current track.

### Fast Forward/Fast Rewind

With the vehicle in P (Park), hold ►| or ◀| for approximately one and one-half seconds to fast forward or fast rewind at a rate of eight times normal playback. If ►| or ◀| are held for approximately six seconds, the rate of fast forward or fast rewind will increase.

### Play/Pause

Press ► to play or || to pause, depending on the current selection.

### Keypad for DVD/VCD/SD/USB

With the vehicle in P (Park), press to display the DVD keypad. DVD keypad functionality is disc dependent and may not be available on all DVDs. Up to four digits can be entered. Press Clear to remove one digit in the entry field. Press and hold Clear to remove all digits in the entry field.

### Pop Up Menu (BD Only)

This displays the pop up menu contents for the BD. Make a selection to exit the pop up menu view.

### Cursor

The cursor is used to navigate and select items in the disc menu. Press the up, down, right, or left arrows, or the ENTER button. The cursor will close after a selection or time out.

### Sourcing USB/SD/VCD/AUX with Video

With the vehicle in P (Park), video can be watched on the front screen from devices plugged into the rear pod. The following icons will be available:



These features will function the same as in DVD/BD sources, with the following exceptions:

- KEYPAD is only available for VCD in P (Park).
- DISC MENU is only available for disc sources such as VCD. The system displays the menu provided by the disc.

### Sourcing DVD/BD/USB/SD/VCD

With the vehicle in D (Drive), the following icons display along the bottom of the front screen when one of these sources is active:



DVD/BD/USB/SD/VCD: All five buttons are available.

AUX: Only REAR MEDIA and MENU are available.

### Rear Media

Use REAR MEDIA to select AUX, Disc, USB, or SD sources for the Rear Seat Entertainment (RSE). When using the REAR MEDIA button to select a source, both rear screens will be sourced and begin playback of the first available file. The video will only display on the front screen if the vehicle is in P (Park). When the vehicle is in any other gear, the front screen displays the active media source.

### Previous Track/Next Track

Press ◀ or ▶ to select the previous or next track on the current media.

### Play/Pause

Press ▶ to play or || to pause, depending on the current selection. A time bar displays when the pause button is pressed.

### Menu (DVD/BD/SD/USB/AUX/VCD)

MENU is only available in D (Drive). Press the MENU button to display these menu options:

- Tone Settings
- Auto Volume Control
- Traffic Announcements

### Tone Settings (DVD/BD)

Tone settings for bass, mid, and treble are available in any source mode. Once set, tone settings are set for all sources.

### Auto Volume Control (DVD/BD)

Automatic Volume Control (AVC) adjusts the volume of the audio based on the speed or ambient noise of the vehicle. Some vehicles may be equipped with the Bose AudioPilot system. In these cases, the Auto Volume main menu item is replaced with the Bose AudioPilot menu item. AVC or Bose AudioPilot is available to use with any source mode.

### Traffic Announcements (DVD/BD)

Traffic program alerts will display in the RSE system. The video will continue to play and the audio will mute, depending on the alert.

### Closing the Menu (DVD/BD)

Press the Back or Exit button to close a menu. This will return to the RSE application on the previously viewed screen.

### Power

Press the power button on the screen to turn the rear RSE screens on or off. The front screen will continue to operate when the rear screens are turned off. The rear screens can be turned back on by pressing the power button again or from the rear seat by using the remote. Select SCREEN 1 or 2 and press the power button.



## Headphones



1. Power Indicator Light
2. Channel 1 or 2 Switch
3. Volume Control
4. Power Button
5. Battery Cover

RSE includes two or four 2-channel wireless headphones depending on the vehicle model. The headphones are used to listen to various multimedia. The wireless headphones have a power button, Channel 1 or 2 switch, and a volume control.

Press the power button to turn on the headphones. A light on the headphones comes on. If the light

does not come on, check the batteries. Intermittent sound or static can also indicate weak batteries. See “Battery Replacement” later in this section.

Turn the headphones off when not in use.

Press the center of the right side of the headphone to change the channel. Channel 1 will provide audio associated with screen 1 and channel 2 will provide audio associated with screen 2.

Infrared transmitters are on the top of the left seatback video screen or in front of the second overhead screen. The headphones shut off automatically to save the battery power if the RSE system is off or if the headphones are out of range of the transmitters for more than three minutes. Moving too far forward or stepping out of the vehicle can cause the headphones to lose the signal or have static.

Use the volume control on the headphones to adjust the volume.

For best audio performance, wear the headphones as indicated with L (Left) and R (Right) on the ear pads. Do not let anything cover the ear pads.

### Caution

Do not store the headphones in heat or direct sunlight. This could damage the headphones and repairs will not be covered by the warranty. Storage in extreme cold can weaken the batteries. Keep the headphones stored in a cool, dry place.

If the foam ear pads become worn or damaged, the pads can be replaced separately. To purchase replacement ear pads, call 1-888-293-3332 or contact your dealer.

### Battery Replacement

To change the batteries:

1. Loosen the screw to the battery door on the left side of the headphones.
2. Slide the battery door open.
3. Replace the two AAA batteries.
4. Replace the battery door and tighten the screw.

Remove the batteries if the headphones will not be used for a long time.

### Auxiliary Inputs

#### Audio/Video (A/V) Jacks

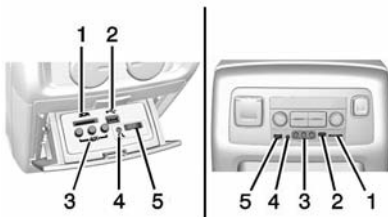

#### Rear Media Connections (As Equipped)

1. SD Card Reader
2. USB Port
3. A/V Jacks
4. Wired Headphone Jack
5. Volume Control

If equipped with RSE, an SD card reader (1), a USB port (2), A/V input jacks (3), wired headphone jack (4), and a volume control (5) will be inside the rear storage area of the center console.

The A/V jacks allow audio or video cables to be connected from an auxiliary device such as a camcorder or video game system.

The A/V jacks are color coded:

- Yellow for video input
- White for left audio input
- Red for right audio input

Power for the auxiliary devices is not supplied by the infotainment system.

To use the auxiliary inputs of the RSE system:

1. Connect the auxiliary device cables to the A/V jacks.
2. Power on both the auxiliary device and the RSE video screen.

### USB/SD

This allows for video and audio playback of supported media.

To use the USB and SD:

1. Insert the device in the appropriate slot.
2. Select the source via the rear screen menu with the remote control MEDIA button.
3. Select the source via the front by pressing on the Video application on the home screen.

### Audio Output

Audio from a Blu-ray/DVD/CD player or auxiliary inputs can be heard through:

- Wireless headphones
- Vehicle speakers
- Vehicle wired headphone jack

The RSE system transmits the audio signal to the wireless headphones if an audio signal is available. See “Headphones” earlier in this section.

### Wired Headphone Jack

Audio from the wired headphone jack can be heard from the desired source through the MENU button on the remote and by selecting Settings, then Headphones. The headphone audio is selected based on the audio associated with screen 1 or screen 2.

The front seat passengers are able to listen to playback from the A/V jacks through the vehicle speakers by selecting Rear A/V as the source on the radio.

### Remote Control

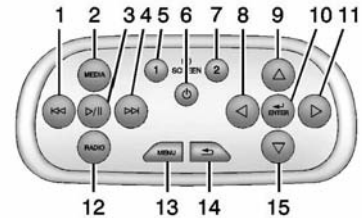

### Remote Control Buttons

1. (Previous/Reverse)
  - Radio: Press to seek the previous radio station.
  - CD: Press to seek the previous track.
  - Blu-ray/DVD: Press to seek the previous chapter.
  - Press and hold for fast reverse.
2. MEDIA
  - Press to scroll through the menus including: CD, AUX, Blu-ray/DVD, SD, USB.

## 52 Infotainment System

---

### 3. ▶/|| (Play/Pause)

- Press to start playing. Press to pause. Press again to continue playing.

### 4. ⏮ (Next/Fast Forward)

- Radio: Press to seek the next radio station.
- CD: Press to seek the next track.
- Blu-ray/DVD: Press to seek the next chapter.
- Press and hold to fast forward.

### 5. SCREEN 1

- For dual seatback screens: Press to select the left screen. Once pressed, all remote control commands will only pertain to screen 1.

- For single overhead screens:

Press to change the source displayed on the overhead screen to SCREEN 1 selected source. Select audio sources. Only one video can be played on the screen at a time. Audio for both sources will continue on the headphones. Once pressed, all remote control commands will correspond to SCREEN 1.

- For dual overhead screens: Press to select the second row overhead screen. Once pressed, all remote control commands will correspond to SCREEN 1.

### 6. ⏻ (Power)

- Press to turn the video screens on and off.

### 7. SCREEN 2

- For dual seatback screens: Press to select the right screen. Once pressed, all remote control commands will only pertain to SCREEN 2.

- For single overhead screens:

Press to change the source displayed on the overhead screen to SCREEN 2 selected source. Only one video can be played on the screen at a time. Audio for both sources will continue on the headphones. Once pressed, all remote control commands will correspond to SCREEN 2.

- For dual overhead screens: Press to select the optional third row overhead screen. Once pressed, all remote control commands will correspond to SCREEN 2.

8. ◀ (Previous/Reverse/Decrease)

- Radio and CD: Press to go to the previous station or track.
- Press to go to the previous menu.
- Press to decrease the brightness of the RSE screen.

9. ▲ (Up Arrow)

- Press to scroll up a list.

10. ⬅ /ENTER

- Press to select the highlighted choice in any menu.
- Press and hold for quick play.

11. ▶ (Next/Forward/Increase)

- Radio and CD: Press to go to the next station or track.

- Press to go to the next menu.
- Press to increase the brightness of the RSE screen.

12. RADIO

- Press to scroll through the radio sources including AM, FM, or XM (if equipped).

13. MENU

- Press to go to the menu of the now playing screen.

14. ↶ (Back)

- Press to go back to the previous menu.
- Press and hold to go back to the now playing screen.

15. ▼ (Down Arrow)

- Press to go down a list.

To use the remote control, aim it at the transmitter window at either seatback console or at the second row overhead screen and press the buttons firmly. Direct sunlight or very bright light could affect the ability of the RSE transmitter to receive signals from the remote control. Check the batteries if the remote control does not seem to be working. See "Battery Replacement" later in this section. Objects blocking the line of sight could also affect the function of the remote control.

 **Caution**

Storing the remote control in a hot area or in direct sunlight can damage it, and the repairs will not be covered by the warranty. Storage in extreme cold can weaken the batteries. Keep the remote control stored in a cool, dry place.

### Battery Replacement

To change the remote control batteries:

1. Insert a coin or key to pull up the rear cover on the remote control.
2. Replace the two AAA batteries in the compartment.
3. Replace the battery cover.

Remove the batteries from the remote control if it will not be used for an extended period of time.

### RSE Troubleshooting

**No power:** The ignition might not be in ON/RUN or ACC/ACCESSORY.

**The picture does not fill the screen. There are black borders on the top and bottom or on both sides or it looks stretched out:**

Press the MENU button on the remote control to change the display mode setting.

**In auxiliary mode, the picture moves or scrolls:** Check the auxiliary input connections at both devices.

**The remote control does not work:** Check to make sure the remote control is programmed to the correct screen. Make sure there is no obstruction between the remote control and the transmitter window and check the batteries to make sure they are not dead or installed incorrectly.

**There is no sound from the headphones with the indicator light on:** If the batteries are good, make sure the headphones are programmed to the correct screen and on the correct channel for the screen being viewed.

**The auxiliary source is running but there is no picture or sound:** Check that the RSE video screen is in the auxiliary source mode by pressing the MEDIA button on the remote control. Check the auxiliary input connections at both devices.

**Sometimes the wireless headphone audio cuts out or buzzes:** Check for obstructions, low batteries, reception range, and interference from cell phone towers or from cellular telephone use in the vehicle. Check that the headphones are on correctly using the L (Left) and R (Right) on the headphones. Check that the headphones are positioned properly with the headband across the top of the head.

**I lost the remote and/or the headphones:** See your dealer for assistance.

**The Blu-ray/DVD is playing, but there is no picture or sound:** Check that the RSE video screen is sourced to the Blu-ray/DVD player by pressing the MEDIA button on the remote control.

## Video Display Error Messages

The video screen may display one of the following:

**Disc Error:** There are disc load or eject problems, the disc is inserted with the disc label wrong side up, the disc is damaged, or the disc is not from the correct region.

**No Disc Inserted:** No disc is present.

**Disc Player Error:** The temperature is outside the operating range of the RSE system. If the temperature is within range, see your dealer.

## Video Distortion

Video distortion can occur when operating cellular phones, scanners, CB radios, Global Positioning Systems (GPS), two-way radios, mobile faxes, or walkie talkies.

It might be necessary to turn off the video player when operating one of these devices in or near the vehicle.

## Rear Seat Entertainment (RSE) System (Platinum)

Vehicles with an RSE system include two head restraint video display screens with integrated DVD players, auxiliary inputs, two wired headphones, and remote control. This system works independently from the vehicle's Overhead DVD RSE system. See *Rear Seat Entertainment (RSE) System on page 36* or *Rear Seat Entertainment (RSE) System (Platinum) on page 55* for information about the Overhead DVD RSE system.

The vehicle has a feature called Retained Accessory Power (RAP). With RAP, the RSE system can be played even after the ignition is turned off. See "Retained Accessory Power (RAP)" in the owner manual.

## Video Display Screens

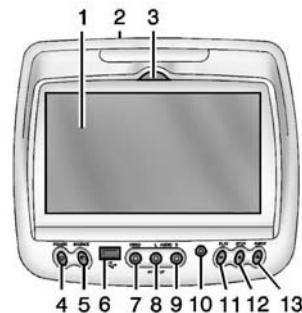

The video display screens are located on the back of each head restraint.

### Caution

Avoid directly touching the video screen, as damage can occur. See "Cleaning the Video Screens" later in this section for more information.

### RSE Overview System

The loading slot for the DVD player is located at the top of the head restraint. Insert the disc partially into the loading slot with the printed side facing the rear of the vehicle. The DVD player automatically draws the disc in, “Loading” displays on the screen along with a disc indicator, and playback starts. If the disc is inserted incorrectly, the DVD player ejects the disc and “No Disc” displays.

Some DVDs do not allow fast forwarding or skipping of the copyright information or previews. If the DVD does not begin playing at the main title, refer to the on-screen instructions.

The DVD player can be controlled by using the buttons below the video display screen or by using the buttons on the system’s remote control. See “Remote Control” later in this section.

The following discs are compatible with the DVD player:

- DVD-Video: A DVD that has video.
- CD-DA: A CD that has music or sound content only.
- CD-Video: A CD that has a movie.
- CD-R/RW: A disc that has audio files such as CD-R with downloaded MP3 files, MPEG, or JPEG files.

The DVD player and discs are coded by global region. The DVD players are set to Region 1. Discs with other region codes will not work in the players.

If an error message displays on the video screen, see “DVD Messages” later in this section.

While the vehicle is moving, passengers should not unfasten their safety belts to make adjustments to the video screen control buttons. See “Safety Belts” in the owner manual. Use the

remote control for any necessary adjustments. See “Remote Control” later in this section.

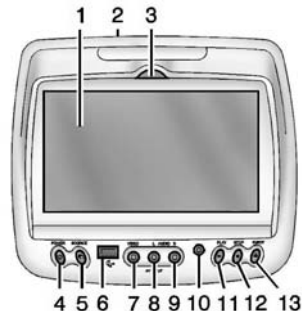

1. Video Screen
  - Located behind the front seat headrest.
2. CD/DVD Slot
  - The loading slot for the DVD player is located at the top of the head restraint. Insert the disc partially into the loading slot with the printed side facing the rear of the vehicle. The DVD



player automatically draws the disc in, "Loading" displays on the screen along with a disc indicator, and playback starts. If the disc is inserted incorrectly, the DVD player ejects the disc and "No Disc" displays.

### 3. Lever Lock and Release Latch

- The viewing angle of the video screen can be adjusted by releasing the latch and gently moving the screen. Then lock it into a secure position.

### 4. POWER

- Press to turn the power on or off. Each video screen can be powered on or off independently.

### 5. SOURCE

- Press to select between Monitor 3, Monitor 4, or the AV INPUT. Each video display screen can be adjusted independently, as

well as display information from both DVD players and both A/V inputs.

### 6. USB Port

- Connect the USB drive to listen to music or view pictures. To charge devices, connect it to the USB port. Not all devices are able to be charged. For playback, the formats available are:

- JPEG
- JPG
- M2V
- MP3
- MPE
- MPEG-1
- MPEG-2
- MPG
- OGG
- WMA

### 7. Video Input

- The yellow connector is used for video input.

### 8. Left Audio Input

- The white connector is used for the left side audio.

### 9. Right Audio Input

- The red connector is used for the right side audio.

### 10. 3.5 mm (1/8 in) Output Jack

- Wired headphones can be plugged in with a 3.5 mm (1/8 in) jack.

### 11. PLAY

- Press this button located below the video display screen to start playback of a disc. On DVDs and video CDs with playback control (PBC), menu screens can display automatically. It might be necessary to press the play button again to begin

play. There is a play position memory feature for DVD and video CD only. If the DVD player is turned off and then turned back on, the DVD player resumes playback where the disc stopped. The play position memory is erased if the disc is removed.

### 12. STOP ■

- Press once to stop playing a DVD.

There is a pre-stop feature for DVD and video CD only. This feature resumes playback of the disc where it was stopped. Press the stop button once during disc playback and ■ displays on the DVD startup screen. This icon disappears after a few seconds. Press the stop button a second time, or eject the disc, to cancel

the pre-stop feature and to clear the disc position memory.

### 13. EJECT ▲

- Press to eject a disc from the DVD slot.

If a disc is ejected from the player, but not removed, it will automatically reload into the player. Another way to reload a disc that has been ejected, but not removed from the DVD player, is to press the eject button or the play button.

**Infrared Remote Sensor:** Located in the top center of the video display screen. Do not block the signal from the remote to the sensor.

**Infrared Transmitters:** Located in the top center of the video display screen. Do not block the signal from the headphones to the transmitter.

## Using the RSE On-Screen Display (OSD) Menus

Use the OSD setup display menus for:

- General Setup
- Audio Setup
- Quality Setup
- Preference Setup

To use the OSD menus while using the DVD player or an auxiliary device:

1. Press the SETUP button on the remote control to display the icons and pages on the display screen.
2. Select the desired page by using the left/right navigation arrows to move the cursor.
3. Press the SETUP button again on the remote control to cancel use of the setup display.

Not all DVDs support all of the feature defaults in the setup menus. If a feature is not supported, the defaults are provided by the DVD media.

### General Setup Menu

To set the language for the OSD:

1. Press the SETUP button on the remote control.
2. Use the left/right navigation arrows to navigate the General Setup Page, then use the down navigation arrow to select the OSD language.
3. Press the ENTER button and then use the right or left navigation arrows to select English, Simple/Traditional Chinese, French, German, Italian, Spanish, Portuguese, or Korean. Press the left navigation arrow to go back to the previous menu.

The angle mark allows different viewing angles on the DVD player. To set the angle mark:

1. Press the SETUP button on the remote control.
2. Use the left/right navigation arrows to navigate the General Setup Page, then use the down navigation arrow to select the OSD language.
3. Press the ENTER button and then use the right or left navigation arrows to select On or Off. Press the left navigation arrow to go back to the previous menu.

### Audio Setup Menu

The Audio Setup Menu is available when a disc is not loaded.

To set the speaker setup:

1. Press the SETUP button on the remote control.
2. Use the left/right navigation arrows to navigate the Audio Setup Page.

3. Press the down navigation arrow to select the Speaker Setup sub-menu and to adjust the speakers setting. Choose from LT/RT, Stereo, V SURR, and OFF.
4. Press the ENTER button and then use the left or right navigation arrows to select a speaker option. Press the left navigation arrow to go back to the previous menu.

The Dolby Digital Setup Menu speaker options are L-Mono, R-Mono, and Mix-Mono.

### Quality Setup Menu

To set up the video quality setup menu:

1. Press the SETUP button on the remote control.
2. Use the left/right and down navigation arrows on the remote control to select the Video Quality Setup sub-menu.

3. Press the ENTER button, and use the left or right navigation arrows to adjust the following:

**Sharpness:** Adjust to soften or sharpen the picture. Use the right or left navigation arrows to choose from Low, Med, or High.

**Brightness:** Adjust to brighten or darken the picture. Use the right or left navigation arrows to choose from -20 to +20.

**Contrast:** Adjust to increase or decrease the picture contrast. Use the right or left navigation arrows to choose from -16 to +16.

**Hue:** Adjust to increase or decrease the color hue. Use the right or left navigation arrows to choose from -9 to +9.

**Saturation:** Adjust to increase or decrease color intensity. Use the right or left navigation arrows to choose from -9 to +9.

### Preference Setup Menu

To set the audio playback language:

1. Press the SETUP button on the remote control.
2. Use the left/right and down navigation arrows on the remote control to select the Audio sub-menu under the Preference Page.

To turn the Subtitles on or off:

1. Press the SETUP button on the remote control.
2. Use the left/right and down navigation arrows on the remote control to select the Subtitle sub-menu under the Preference Page and use the left or right navigation arrows to choose On or Off. Press the left navigation arrow to go back to the previous menu.

To set the disc menu language:

1. Press the SETUP button on the remote control.
2. Use the left/right and down navigation arrows on the remote control to select the Disc sub-menu under the Preference Page and use the left or right navigation arrows to select the language. Press the left navigation arrow to go back to the previous menu.

To set up the Parental Control:

1. Press the SETUP button on the remote control.
2. Use the left/right and down navigation arrows on the remote control to select the Parental sub-menu under the Preference Page.
3. Press the SETUP button, and use the right and up/down navigation arrows to select any one of the available Rating settings from the display menu.

The Rating settings are:

- Kid SAFE (Children)
- G
- PG
- PG 13
- PG R
- R
- NC 17
- ADULT

4. Press the left navigation arrow to confirm the selection.

If a disc is inserted into the DVD compartment slot and it exceeds the Parental Setting, the following message appears on the display:

*The Parental Setting of this player prohibits play. Would you like to allow this disc to play?*

If yes if selected, the six digit password must be entered for the disc to play. If the wrong password is entered, the following message appears:

*This movie will not play due to the Parental Setting of the player.*

To create a six digit password, use the numeric keypad on the remote control. Press the ENTER button to confirm. *The default password is 136900.*

To change the Parental Control Password:

1. Press the SETUP button on the remote control.
2. Navigate to the Password sub-menu under the Preference Menu and press ENTER.
3. At the Old Password option, enter the old password or the default password (136900).
4. At the New Password option, enter the new password (six digits) using numeric buttons.

5. At the Confirm PWD option, confirm the new password by entering the new password again.
6. Scroll to the OK button and press ENTER. The message "Your password has been changed" displays.

To reset the system back to the factory default settings:

1. Press the SETUP button on the remote control.
2. Use the left/right and down navigation arrows on the remote control to select the Default sub-menu under the Preference Page and press the ENTER button to reset the settings. The parental settings will not be affected.

### Vehicle Speakers

Audio from the DVD player or an auxiliary device can be heard through the vehicle speakers or the wireless/wired headphones, while the radio is tuned to one of the

many frequencies selected on the Sound Around portion of the system's remote control. See "Remote Control" later in this section.

Only one audio source can be heard through the vehicle's speakers at a time. The audio source being used is specified by the A/V (audio/video) source selected on the driver side head restraint video display screen.

To turn the RSE system audio output to the vehicle's speakers, press Sound Around ON, on the system's remote control. The audio from the RSE system can be heard through the wireless/wired headphones and the vehicle's speakers at the same time. The volume on the radio can vary when switching between the radio, CD, DVD, MP3, or an auxiliary device.

### Wired Headphones

**VOL**  (**Volume**): Use to adjust the volume on the headphones.

### 100 Channel FM-Modulation Control

#### For Monitor "A" Only:

To activate the FM modulation feature, press the "Sound Around On/Off" button on the remote until the text "FM CH XX.XMHZ" is displayed on the monitor.

On the remote, press the "Sound Around Select" button to cycle through a pre-established list of 6 channels (88.3MHz, 88.7MHz, 89.1MHz, 89.5MHz, 89.9MHz, 90.3MHz.)

If none of these stations are suitable for FM Modulation, use the "Fine Tune" Option. To "Fine Tune" the modulator to a specific target station while the display is active, press the "Up" or "Down" keys on the remote to change the channel by 0.2MHz. Hold down the "Up or "Down" keys to cycle quickly through the stations. When the end (107.9MHz) or beginning (87.5MHz) of the FM band is reached, the channels will

continue from the beginning (87.5MHz) or end (107.9MHz), respectively.

To deactivate the FM modulation feature, press the "Sound Around On/Off" button on the remote until the text "FM OFF" is displayed on the monitor.

### Caution

Do not store the headphones in heat or direct sunlight. This could damage the headphones and repairs will not be covered by the warranty. Storage in extreme cold can weaken the batteries. Keep the headphones stored in a cool, dry place.

### Remote Control

To use the remote control, aim at the remote sensor on top center of the video display screen and press the desired button.

Objects blocking the line of sight can affect the function of the remote control. Direct or very bright light can affect the ability of the transmitter to receive signals from the remote control. If the remote control does not seem to be working, the batteries might need to be replaced. See “Battery Replacement” following this section.

The remote control provided with the Headrest DVD RSE system is not a universal remote control and will not control other equipment.

### Caution

Storing the remote control in a hot area or in direct sunlight can damage it, and the repairs will not be covered by the warranty. Storage in extreme cold can weaken the batteries. Keep the remote control stored in a cool, dry place.

### Remote Control Buttons



**POWER:** Press to turn the Headrest DVD RSE system on and off.

**SOURCE:** Press to select between Monitor 3, Monitor 4, or AV INPUT. Any video equipment connected to the AV inputs automatically overrides the source selection.

**SETUP:** Press to change the default settings. See “Using the RSE On-Screen Display (OSD) Menus” earlier in this manual. There are four main menu screens. Each screen displays a menu to select different setting options. The screens are:

1. General Setup — adjusts screen settings.
2. Audio Setup — sets the language.
3. Preference Screen — sets the subtitles and parental controls.
4. Password Setup — allows a password to be set.

Press **SETUP** again to exit.

**EJECT**  : Press to eject or reload a disc.

**DVD-Video Screen 3:** Press the DVD button located under 3 to transmit IR codes for DVD mode on Video Screen 3.

**TV-Video Screen 3:** This button is not used with the system.

**DVD-Video Screen 4:** Press the DVD button located under 4 to transmit IR codes for DVD mode on Video Screen 4.

**TV-Video Screen 4:** This button is not used with the system.

**SOUND AROUND ON/OFF:** Press to turn the FM Transmitter power on or off.

**MUTE**  (For DVD Only): Press to turn off the headphone sound. Press again to turn the sound on again.

**PIX (Picture Selection):** Press to adjust the picture's On Screen Display (OSD). Each time this button is pressed, the picture adjustment OSD cycles through bars for BRIGHTNESS, CONTRAST, COLOR, and TINT. Use the right/left navigation arrows to adjust the setting. This feature automatically shuts off if another button is pressed or adjustments are not made within six seconds.

**SOUND AROUND SELECT:** Press to select an FM transmitter channel. The SOUND AROUND SELECT lets the DVD audio play over the vehicle's sound system by tuning the radio to one of the many FM frequencies.

**MENU:** Press to enter the DVD disc menu while the disc is playing.

**▲, ▼, ◀, ▶ (Navigation Arrows):** Press to navigate through menus.

**CH + (Channel):** Press to change the channel to a higher level in sequential order.

**CH - (Channel):** Press to change the channel to a lower level in sequential order.

**VOL +:** Press to adjust the sound louder.

**VOL -:** Press to adjust the sound lower.

**ENTER:** Press to enter a selected function or to begin playback of the disc.

**REPEAT** : Press to repeat part or all of a chapter, title, track, or the entire disc after using the A-B button to setup repeat preset sections.

**TITLE:** Press to enter the disc title mode. The title feature is disc-specific, and may not be available on all discs.

**SUBTITLE:** Press to change the subtitle language to another available language or to turn subtitles off.

**ANGLE:** Press to select a different viewing angle for discs that are recorded with different camera angles.

**AUDIO:** Press to select a different language for discs that are recorded with different languages.

**0-9 (Numbers):** The numbers located on the lower left side of the remote control can be used to enter numbered menu options, channels, or track numbers.



**DISPLAY:** Press to scroll through display information on the upper left corner of the screen, such as title, chapter/track, time elapsed, and time remaining, or to turn off the display

**RANDOM:** Press to play titles randomly.

**PLAY/▶:** Press to start playback of the disc.

**STOP ■:** Press to stop playback of a disc.

**PAUSE ||:** Press to pause playback of a disc.

- To resume disc playback, press PLAY.
- To start playback from the beginning of the disc, press STOP, STOP, then PLAY.

**0–9 (Numbers):** The numbers located on the lower left side of the remote can be used to enter numbered menu options, channel, or track numbers.

**CLR (Clear):** Press to clear the previous menu selection.

**INT (Initialize):** Press to start the process of programming a selected menu item on the remote control.

**FR ◀◀ (Fast Reverse):** Press to fast reverse the disc. Press multiple times to choose between 2X, 4X, 8X, 16X, and 32X speeds.

**FF ▶▶ (Fast Forward):** Press to fast forward the disc. Press multiple times to choose between 2X, 4X, 8X, 16X, and 32X speeds.

**PREV ◀◀ (Previous):** Press to play the previous chapter or track. To return to previous chapters or tracks one at a time, press and release multiple times until the desired chapter or track is reached.

**NEXT ▶▶:** Press to play the next chapter or track. To go to the next chapter or track one at a time, press and release multiple times until the desired chapter or track is reached.

## Battery Replacement

To change batteries in the remote control:

1. Turn the remote control face down.
2. Press down on the ridged area of the battery cover and slide it off.
3. Install two AAA batteries into the battery compartment.
4. Slide the cover back on until it clicks.

If the remote control is to be stored for a long period of time, remove the batteries and keep it in a cool, dry place.

## Playing Audio CD

When an audio CD is playing, the display shows the current track and the amount of time that track has been playing, the total amount of time on the disc, and the current time running on the disc.

**DISPLAY:** Press to choose from the following display options:

1. Press DISPLAY once and Single Elapsed appears along with the current track playing and the length of time for that track.
2. Press DISPLAY twice and Single Remain appears along with the current track playing and the amount of time left on the track.
3. Press DISPLAY three times and Total Elapsed appears along with the current track playing and the total time that has played on the CD.
4. Press DISPLAY four times and Total Remain appears along with the current track playing and the amount of time left on the CD.

**REPEAT:** Press to toggle between Track and All. The default for repeat is OFF.

- Track repeats the track that is playing.
- All repeats the disc that is playing.

### Playing MP3 CD

MP3 is the format for storing digital audio. An audio CD quality song can be compressed into the MP3 format with very little loss of quality, while taking up much less space. CD-R/RW discs that have been encoded in MP3 format can be played on the DVD player.

### Selecting Folders and Songs

When an MP3 disc is inserted in the player, the navigation screen appears. The folders and songs can be changed by navigating through the file system. The DVD player plays the songs in the order they were burned to the disc.

1. Press STOP if a disc is playing. Press the up or down navigation arrows on the remote control to go through the folder list on the left side of the screen.
2. Press ENTER when the desired folder is highlighted.

3. Press the up or down navigation arrows to go through the song list and highlight the desired song. Press ENTER to begin the playback of the selected song.

### Skipping a Song

**NEXT:** Press to go to the next song.

**PREV (Previous):** Press to return to the beginning of the song that is currently playing. Press PREV twice to go to the previous song.

### Selecting a Play Mode

The order the songs are played can be temporarily chosen on a disc. The FOLDER play mode is the default. Press the REPEAT button to access the play mode options.

The play mode options are:

- Single — Play a selected song.
- Folder — Play the folder in the order the songs were recorded.

- Shuffle — Play the songs in random order, from within the selected folder.

### Using the REPEAT Feature

**REPEAT:** Press to change between Repeat One and Repeat Folder.

- Repeat One — Repeats the song that is playing.
- Repeat Folder — Repeats the folder that is playing.

### Tips and Troubleshooting

**IR Sensor Inoperative:** Check that the batteries are good in the remote control. Check that the remote Control IR Sensor is not blocked. Aim the remote control toward the IR Sensor being controlled. Select the correct screen, 3 or 4.

**No picture:** Check that the correct video input mode is selected. Check that the video cable is plugged into the jack securely.

**No Sound:** Check that the correct audio input mode is selected. Check that the audio cable is securely plugged into the jack.

### Cleaning the Video Screens

The video display screens are made of a specially coated glass and can be scratched or damaged by abrasive products, solvents, or ammonia-based window cleaners. Clean with a soft, lint-free, cotton cloth that has been slightly dampened with warm water. Dry the screens by wiping with a clean dry cotton cloth.

### Cleaning the Components

Use care when touching or cleaning the components such as the DVD player or the discs.

Do not use DVD lens cleaners for DVD players because the lens of the DVD optics can become contaminated by lubricants.

Handle CDs and DVDs carefully. Store them in their original cases or other protective cases and away from direct sunlight and dust. The DVD player scans the bottom surface of the disc. If the surface of a CD or DVD is damaged, such as cracked, broken, or scratched, the CD or DVD may not play properly or not at all. If the surface of a CD or DVD is soiled, take a soft, lint free cloth or dampen a clean, soft cloth in a mild, neutral detergent solution mixed with water, and clean it. Make sure the wiping process starts from the center to the edge.

Do not touch the bottom side of a CD or DVD while handling it; this could damage the surface. Pick up CDs or DVDs by grasping the outer edges or the edge of the hole and the outer edge.

## Navigation

### Using the Navigation System

If equipped, press the NAV button on the Home Page or the NAV icon in the applications tray to access the navigation application.

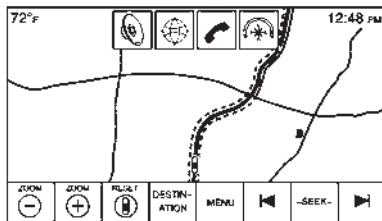

Press MENU from the map view to access the Navigation Menu. Features displayed in the Navigation Menu can be selected to adjust navigation preferences.

To exit out of a list, press the EXIT screen button in the top right corner of the map to return to the main map view.

It is advised to set up preferences before setting a destination. To set a destination, see *Destination on page 79*.

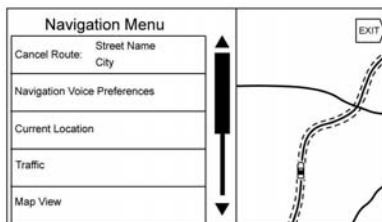

Additional navigation features are:

- Cancel/Resume To
- Navigation Voice Preferences
- Current Location
- Traffic
- Map View
- Routing Preferences

- Display "Places of Interest" Icons
- Personal Data

#### Cancel/Resume Route

- While under route guidance, this screen button displays Cancel Route. Press Cancel Route to cancel route guidance. No further prompts will be given. The list item then changes to Resume To.
- Press the Resume To screen button to resume route guidance to the last entered destination.
- The last location that the system has provided guidance to can be resumed by pressing on this list item.
- If the route includes waypoints, the entire route can be suspended using the Cancel Route list item. When Resume To is pressed, all waypoints are resumed for guidance.

## Navigation Voice Preferences

Press the Navigation Voice Preferences list item to adjust the voice preferences.

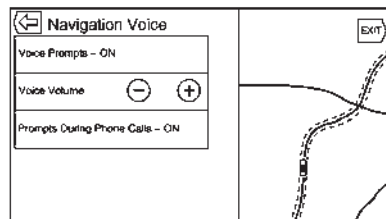

The following options can be adjusted:

- Voice Prompts ON/OFF
- Voice Volume
- Prompts During Phone Calls ON/OFF

### Voice Prompts

Press the Voice Prompts list item to toggle voice prompts ON and OFF.

## Voice Volume

Adjust the loudness of the audio feedback by pressing the – or + button. If a maneuver prompt is being played, and the main volume is adjusted, the prompt volume will update and be saved.

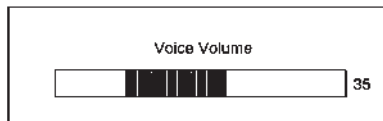

As the volume of the voice guidance is being adjusted, a quick status bar displays, showing the volume setting.

### Prompts During Phone Calls

When enabled, the system plays a shorter prompt while on a phone call. This setting can be configured as to whether a prompt would be heard during a phone conversation.

When this setting is OFF, only the short alert tone is played when approaching the maneuver.

## Current Location

Press the Current Location list item to display a Current Location list.

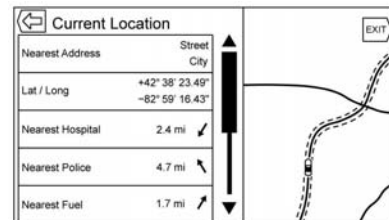

The following information is displayed on the Current Location list:

- Nearest Address
- Lat/Long
- Nearest Hospital
- Nearest Police
- Nearest Fuel
- Nearest Service

Pressing on any of the options will display the destination details view for that location to allow you to begin guidance to the selected location.

Press the Nearest Address button and then the Save screen button to store the current location to the Address Book.

### Display Places of Interest Icons

Places of Interest (POI) icons can be displayed on the map using this view.

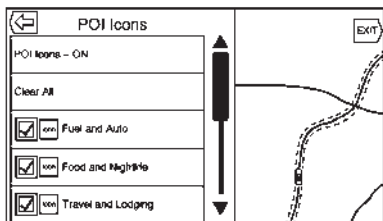

- The POI icons can be turned ON and OFF. Press the check box next to the POI icon to display the icon.

- Press Clear All to reset the icons that are displayed on the map.
- A subcategory can be selected instead of the entire category. Press the list item itself rather than the check box. The subcategories will display. Select any of those categories to navigate down the hierarchy.
- When a higher-level category has some of its subcategories selected, the checkmark next to it is grayed out. This indicates that only some of the categories below are shown. Press the grayed-out checkmark to turn all of the icons for that category on or off.

### Map View

Press to select the desired map view. A checkmark appears to indicate a view has been selected.

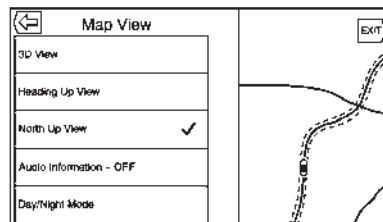

### 3D View

The 3D View is a Heading Up View but it includes perspective. Map items will appear larger as the vehicle comes closer.

### Heading Up View

The Heading Up View keeps the vehicle's current heading at the top of the view. The vehicle icon always faces the top of the view as the map rotates.

### North Up View

The North Up View keeps north at the top of the view. The vehicle icon is placed in the center of the view and rotates to indicate the heading for the vehicle.

### Audio Information On/Off

Press to turn the audio information view on or off from the main map view. When ON, the audio information becomes an audio status pane. This allows for two lines of audio information in the status pane and enables the use of some Interaction Selector controls.

The audio status screen contains the following elements:

- Station Frequency
- Artist Information
- Song Information
- ▶ / || or ◀ / ▶ | Station and Channel Controls

Press the ◀ / ▶ | Station controls to go to the next or previous strong signal station or digital channel.

When the audio status pane displays Artist and Song Information, press the ◀ / ▶ |

controls to go to the next or previous track based on the current media mode.

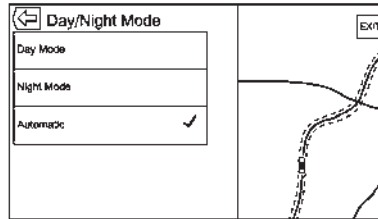

### Day/Night Mode

Press to access the Day/Night Mode menu.

The options are:

- Day Mode: Brightens the map background.
- Night Mode: Darkens the map background.
- Automatic: Adjusts the screen background automatically depending on the exterior lighting conditions.

### Routing Preferences

Press the Routing Preferences list item to access the Routing Preferences menu. Options on how the routes are created for route guidance are listed on this menu.

### Route Style

Press this list item to change the route type preferences.

The options are:

- Fast (default)
- Eco Friendly (if equipped)
- Short
- Configure Eco Profile

The Edit Eco Profile can be used to configure two parameters for the Eco Friendly route. These parameters are roof load and trailer. For each parameter, the options are None, Small, Medium, and Large. Press to scroll through the list. The default for both is None.

These preferences are used for all routes generated.

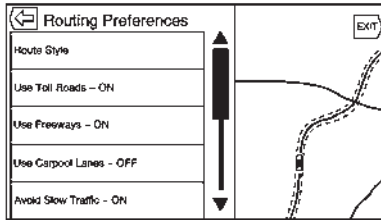

Route segment preferences are other options showing on the Routing Preferences menu.

These include:

- Use Toll Roads ON/OFF
- Use Freeways ON/OFF
- Use Carpool Lanes ON/OFF
- Avoid Slow Traffic ON/OFF
- Use Tunnels ON/OFF
- Use Time Restricted Roads ON/OFF

### Traffic (If Equipped)

Press to browse the traffic in the area as well as adjust the traffic settings. Where traffic information is available, it is displayed on the map.

Where live traffic flow data is available, it is displayed as a solid line adjacent to the road. The road is displayed in colors to show the flow rate as:

- Black – Stopped or Closed
- Red – Poor
- Yellow – Slow
- Green – Normal

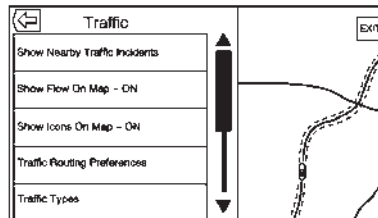

There are several options on the Traffic menu:

- Show Nearby Traffic Incidents
- Show Flow On Map ON/OFF
- Show Icons On Map ON/OFF
- Traffic Routing Preferences
- Traffic Types

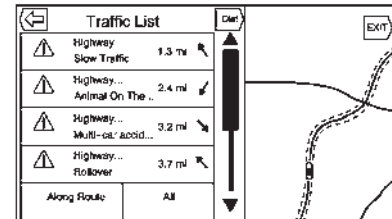

1. Press Show Nearby Traffic Incidents to access the Traffic List menu. This menu displays the incident symbol and highway name, along with the distance and heading to the incident.



- Press on the incident to display additional details about the incident as well as an option to avoid that particular incident if it is along the current route.

### Traffic Routing Preferences

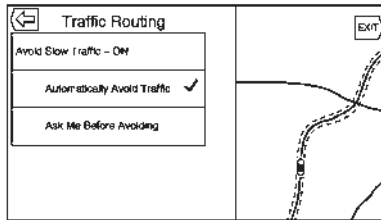

The system can be configured as to how it reacts when receiving traffic information. Press Traffic Routing Preferences to access the Traffic Routing menu.

When this setting is OFF, the system will never take traffic conditions into account when creating routes. In addition, the two options below are grayed out.

If one of the grayed-out options is pressed, it automatically turns the traffic avoidance feature ON and performs the desired selection.

The two options, Ask Me Before Avoiding and Automatically Avoid Traffic, will adjust the system as follows:

- If the Automatically Avoid Traffic list item is pressed, the system will automatically adjust the route based on traffic without notifying the driver.
- If the Ask Me Before Avoiding list item is pressed, the system will always use Alerts to show when there is an incident and allow it to be avoided by pressing the avoid button.

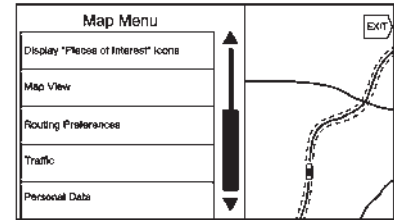

If the Traffic list item is pressed from the Map Menu and Traffic is not available because the SiriusXM subscription is not valid, a pop-up will display with information on how to reactivate the subscription along with the SiriusXM radio ID.

### Traffic Types

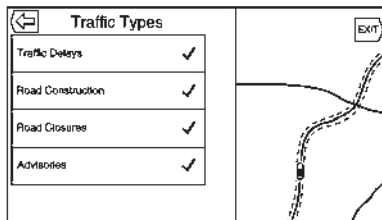

Press to access the Traffic Types menu.

The system can be configured to filter out certain types of traffic events. If a particular type has been turned off, the system does not display it on the map, and does not alert the driver.

### Personal Data

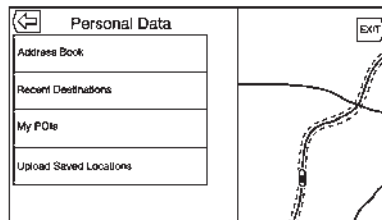

Data that the system has saved during the course of using the navigation system can be managed through:

- Address Book Entries
- Recent Destinations
- My POIs (if equipped)
- Upload Saved Locations

#### Address Book Entries

Press Address Book to edit.

### Recent Destinations

- Press Delete Individual Destinations to display a recent destinations list. Select the individual entry to delete.
- Press Delete All Destinations to delete the entire recent destination list. A pop-up displays asking to confirm the deletion.

### My POIs

- Press My POIs to display a menu of other options.
- Select Delete Individual Categories. A My POIs category list displays.
- Select the individual entry to delete.
- Press Delete All My POIs to delete the entire list of categories. A pop-up displays asking to confirm the deletion.

- To exit out of a list, press the EXIT screen button in the top right corner of the map to return to the main map view.

**Upload Saved Locations:** Press to upload any saved locations such as downloaded POIs and all entries in the vehicle address book to the USB device.

- Press Upload Saved Locations to save the Vehicle Contacts list and any My POIs that have been saved to the vehicle.
- Once saved locations have been uploaded to a USB, they can be transferred to a different vehicle or restored to the current address book.

## Map Adjustments

ZOOM +/- can be used to adjust the scale of view on the map. When the end of the zoom level is reached, ZOOM +/- will gray out.

Use the pinch/spread hand gesture to zoom the scale of view on the map.

- ZOOM – (minus): Pinch fingers together to zoom out.
- ZOOM + (plus): Spread fingers apart to zoom in.

The zoom scales can be configured for English or metric units. To change from English to metric, see “Instrument Cluster” in the owner manual.

## Scroll Features

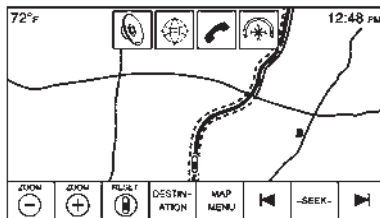

- To scroll within the map, press anywhere on the map screen.

- Nudge or slide a finger on the map; the map moves in the direction of the finger.
- Fling a finger on the map; the map will start scrolling in a short continuous scroll.
- Press a finger on the location on the map; the map recenters to the location that was pressed on.
- Press a finger twice on a location on the map; the map zooms in one level to the location that was pressed twice on.
- When the map is recentered away from being locked to the vehicle position, the crosshairs will show in the center of the map. As the map continues to be recentered, the crosshairs will remain on the screen. When the crosshairs are shown on the screen, a callout with more information displays. If the map

is moved from the current location, the crosshairs will disappear along with the callout.

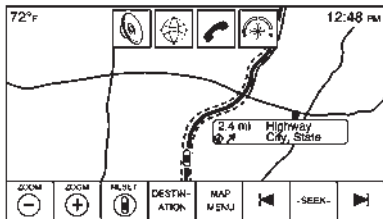

- Press a finger on the callout next to the crosshairs and the destination details view displays. From this view, route guidance can be received or saved to the vehicle's contact list.
- When the map is recentered, the straight-line distance from the vehicle to the selected point is displayed in the callout. In addition, a heading direction in the form of an arrow is displayed to indicate the direction. The arrow is shown in relation to the current vehicle heading.

- Press a finger on a POI icon shown on the map; the name of the POI is shown in the address callout, along with the city name and state. If the callout is selected, the destination details view for the POI is shown.
- After panning the map away from the vehicle, press RESET to return the map to the current position.
- Press the Overview button to quickly get a view of the entire route. The route Overview button takes the place of the RESET button while under route guidance. Press the RESET button to return the map to the current position.

### Maps

The map database is stored in the internal flash memory that is used in the navigation system.

### Detailed Areas

Road network attributes are contained in the map database for detailed areas. Attributes include information such as street names, street addresses, and turn restrictions. A detailed area includes all major highways, service roads, and residential roads. The detailed areas include Places of Interest (POIs) such as restaurants, airports, banks, hospitals, police stations, gas stations, tourist attractions, and historical monuments. The map database may not include data for newly constructed areas or map database corrections that are completed after production. The navigation system provides full route guidance in the detailed map areas.

## Navigation Symbols

Following are the most common symbols that appear on a map screen.



The vehicle symbol indicates the current position and heading direction of the vehicle on the map. When under route guidance, a circle with an arrow is added to the vehicle symbol which indicates the direction to the destination.

### Vehicle Address Callout

Tap on the vehicle icon to overlay the current address of the vehicle next to the vehicle icon in a callout. Tap again to tap hide the information on the map.

Any address information about the vehicle's current location will be shown, including the street, city, and state names.

Tap on this callout to save the current address to the vehicle address book.

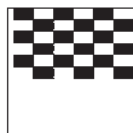

The destination symbol marks the final destination after a route has been planned.

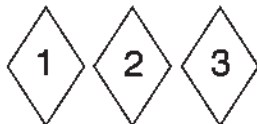

The waypoint symbol marks one or more set waypoints.

A waypoint is a stopover destination point added to the planned route.

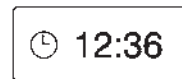

The estimated time to the destination displays. Press the Arrival button to toggle to duration and to the distance of the destination.



This symbol indicates the recommended maneuver that should be performed. Press it to display the turn list or waypoint list.



The No GPS symbol appears when there is no Global Positioning System (GPS) satellite signal. When the GPS is gone, the vehicle position on the map may not be accurate.

### Autozoom

As a maneuver is being approached, the map automatically zooms in to give greater detail.

If lane guidance is available for the maneuver, this is also shown.

When the system begins to autozoom, it zooms in to its minimum level. After the maneuver is performed, the system slowly zooms back out.

### Driving on a Route

#### Maneuver Road Name

If the road name has multiple names, all names are shown.

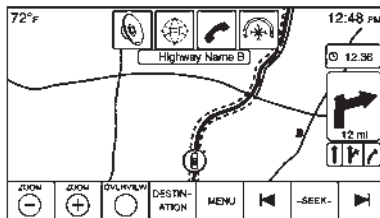

Map View with Proximity

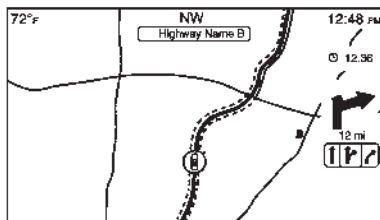

Map View without Proximity

If the road that the system has calculated for the next maneuver has an icon, it will be shown to the left of the maneuver road name.

The distance to the maneuver is shown from the current location along the route to the maneuver.

### Off-Road Indication

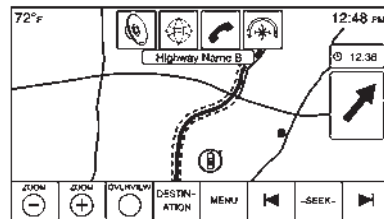

When driving in an area with no road showing on the map, the system transitions to off-road mode. The map displays a destination pointer in the Turn List area. The system will attempt to guide by showing a highlighted route starting at the nearest road. This road name is shown in the next maneuver name field at the top of the screen.

## Navigation Next Turn Maneuver Alert

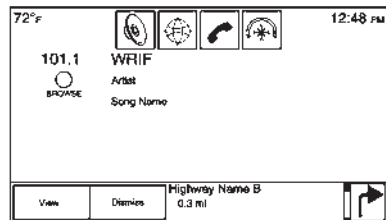

The navigation system may need to get the attention of the driver in certain situations.

If not in the navigation application when a near maneuver prompt is given, it is shown as an alert. The alert contains the turn indicator and button to display the main navigation view or dismiss the alert.

The alert also contains the name of the street to turn on and a countdown bar.

## Destination

If route guidance is not active, press the NAV screen button on the Home Page to access the map view. Press the Destination icon from the map view to enter a destination.

Available methods of entering a destination are Voice Recognition, Address, Recent Destinations, Address, Recent Destinations, Contacts, and POIs. Several options can be selected to plan a route. Some destination items may be grayed out if no destination was previously entered or saved.

Another way to enter a destination is to connect to the OnStar<sup>®</sup> system and ask an OnStar Advisor to download a destination into the embedded navigation system. See *OnStar<sup>®</sup> System on page 95*.

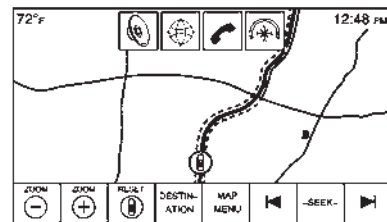

Press the DESTINATION button to go to the destination entry views.

### Available Methods of Search

- Voice Recognition
- Address
- Recent Destinations
- Contacts
- POIs (Points of Interest)

Press the DESTINATION button and the last used destination view is shown. This mode is retained. The initial default is Address.

## Alpha-Numeric Keyboard

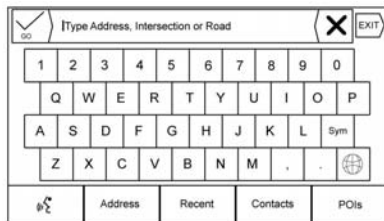

The keyboard is used in multiple locations throughout the system and can be used with many features. The navigation system uses the alpha-numeric system keyboard which includes 1 through 0, A through Z in QWERTY layout, hyphen, comma, period, Space, and Sym which would show additional characters needed.

The keyboard can also be modified to include characters appropriate for the region configured in the vehicle settings.

✓ **GO:** Press to search for the destination details of an address or place of interest entered in the text field. Once the ✓ GO screen button is pressed, the activity indicator displays in the list of possible matches.

▽ (**Dropdown Arrow**): Press to display a list of matches.

When there are multiple matches, a dropdown arrow is shown after the autocomplete text. This dropdown displays an entire list of matches. Press the appropriate match without having to enter more text.

✕ (**Delete**): Press to delete the last typed character. Press and hold this screen button to clear the entire text field. If the entire text field has been deleted, this screen button becomes an Undo button. Pressing Undo will restore the deleted text.

**EXIT:** Press to return to the previous Map view.

**Sym:** Press to show the symbol keyboard.

**Space:** Press to enter a space between characters or the words of a name.

▲ (**Up Arrow**): Press to display the Interaction Selector.

🌐 : Press to switch between Alpha-Numeric Keyboard and Character Recognition.

### Special Characters

As the characters are typed on the keyboard, a pop-up of the letter pressed displays above the key that was pressed.

Continue to press and hold, and any additional special characters associated with that letter are displayed around the current letter. To select one of the special characters, slide a finger left or right to adjust the highlight of the special character.



## Special Character List

The following characters have special characters beneath them:

E - É Ê Ë Ì Í Î Ï	More Characters:
Y - Ÿ	0 - °
U - Ů Ú Ū Ŭ Ů	! - ¡
I - Ĩ Ī Ĭ Ĭ	\$ - ¥ £ ¢
O - Ō Ŏ Œ Ő Ő Ő Ő Ő	& - §
A - Ă Ǻ Ǻ Ǻ Ǻ Ǻ Ǻ Ǻ	^ - ˆ »
S - Š (for lowercase s) Š Š	? - ¿
L - Ł	{ - { {
Z - Ź Ź Ź	} - } }
C - Ć Ć Ć	.com - .net .org
N - Ń Ń	
- - ...	

## Character Handwriting Recognition

Character handwriting recognition is offered as an alternative to using a keyboard. This character input method allows the drawing out of characters instead of picking them out from the keyboard. Character handwriting recognition has two main modes, Upper Case and Mixed Case. The Upper case mode is used for Destination Entry while Mixed Case is used for all other

character entry modes. This feature is available by pressing the globe button from the keyboard screen.

The Handwriting Recognition screen is split into different zones:

- Drawing Pad
- Prioritized Guess List
- Character Entry
- **Drawing Pad:** This is the area to draw a character. Draw a character in the display area.

When the first character is complete, a representation of that character can be seen, and there is an audible response. If the character is correct, the next character can be started immediately.

- To delete the last entered character, draw a line from left to right across the character field.

- To create a space, draw a line from right to left across the character field.

- **Prioritized Guess List:** This area displays a list of guesses for the character drawn. If character recognition displays the incorrect character, look at this list and see if the desired character is available to select. Scroll up or down the list, then highlight the desired character. Selecting a character from the list will replace the incorrect character with the desired character. The character is displayed in the character entry section of the screen.
- **Character Entry:** This is the area across the top of the screen. This section can look different depending on which feature is being used.

### Option Settings

This section is an area on the right side of the Character Recognition screen. This section will only look different if the characters displayed on the screen are in upper case or mixed case.

-  **(Draw Speed Setting):**  
Select from the touch screen. The draw speed setting will adjust the speed of the character recognition feature. The settings are: Faster, Default, and Slower.
- **Audio Feedback:** Press to turn Audio Feedback On or Off.  
Audio feedback is an audible response to an action that has occurred while using the Character Recognition.

- **ABC/abc (Character Set):**  
Select from the touch screen to view the available character sets. Select a character set to change. Multiple character sets may not be supported by some regions. This button also displays the sentence case of upper or lower case characters that are currently active in a mixed case mode. If only one character set is available for the desired region, pressing the character recognition will only open and close the character recognition window.

If mixed case character mode is supported, the last buttons of character recognition will be upper and lower case.

### Address

- A destination can be searched by typing out the address, intersection, highway, or freeway entrance ramps on the keyboard. This information is typed and displayed in the information field. Press the search icon to start the search.

For example:

**Address:** 100 Main Center Crawford, State/Province (if needed)

**Road Name:** Main Rd

**Intersection:** North Square West Road Standish State/Province

**Freeway:** N-94

- State information does not have to be included in the search field if entering an address that is located in the same state.

- Whenever the keyboard view is entered, the last text that was typed, even if it was not searched on, will display.
- A partial or complete address can be typed in the search field. If a partial address is typed, the system attempts to use local knowledge to fill in additional information. For example, if no city name or state are given, the system assumes a search for something in the current city or a nearby city in the current state. The system is also capable of recognizing address formats according to other regions.

If a destination address or location being entered is outside of the country, the country abbreviation must be added after the address. For example, if the current vehicle location is in Detroit MI and the destination is in Windsor, the correct input would be Windsor ON CAN.

**Intersection:** If looking for an intersection, type in the two street names and optionally the city and state/province of the intersection.

**On-Ramp:** If looking for the closest on-ramp as a destination, enter a highway name. The direction is not required but can be specified. The system will search for the closest on-ramp.

Also available is the Exit-Ramp. For example, N-94 Exit 42.

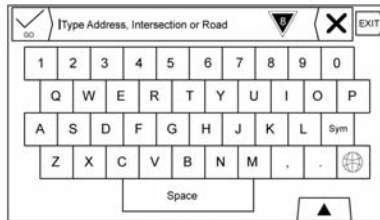

The keyboard may be able to perform an autocomplete function. Depending on the application, autocomplete matches entries that have been previously typed or are stored in a Recent Destinations list.

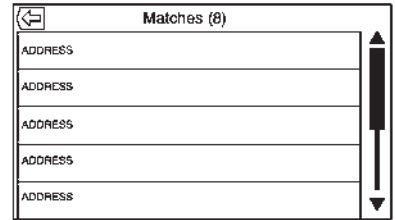

1. After a character has been typed, the system is able to start displaying matches that begin with that character. The matches continually become more refined as additional characters are entered.
2. If there are multiple matches for what has been entered, the first result alphabetically will be shown.

When there are multiple matches, a dropdown arrow is shown after the autocomplete text. This dropdown displays the entire list of matches. Press the appropriate match without having to enter more text.

- If autocomplete does not show the results needed, press the delete screen button to clear the autocomplete from the entered field.

If there are no matches, a pop-up displays in response to show how the system understood the entered text and attempts to show how the text could be entered to help find the destination.

### Multiple Matches

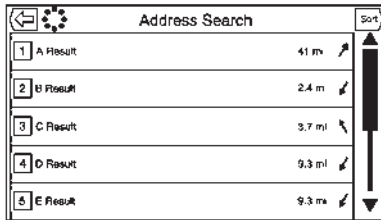

Address Search		Sort
1	A Result 41 mi	▲
2	B Result 2.4 mi	▲
3	C Result 3.7 mi	▲
4	D Result 9.3 mi	▲
5	E Result 9.3 mi	▼

- If the search results in multiple matches, a list of matches is shown.

- Address search results are grouped by result type, in the order of Full Addresses, States, Cities, Intersections, and Streets. If no results are found in a particular group, that group is not shown. If only one type of result is found, the single type result screen is shown. Within each group, they are listed in Confidence order. This means that the closest match result will be at the top.
- Address searches can be sorted by Confidence, Distance, or Alphabetical order.

### Spelling Mistakes

The system is able to offer alternatives if the searched term is not found exactly. The system uses the closest term it finds and provides those results.

The system first searches the entered term exactly. If no matches are found, partial words are used. For example, when entering an address, the system attempts to do a full match on the entire string. If it does not find a match, the house number is then considered an optional term and the system attempts to find the street and city name. The prefix and suffix of street names are also treated as optional terms. The search is first done by trying to match the prefix and/or suffix. If there is no match found, these terms are removed from the search to make the search more generic.

## Places of Interest (POI)

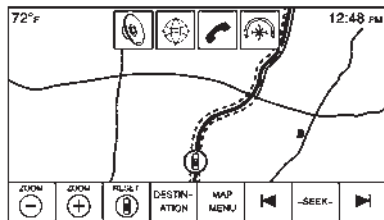

While at the Home Page, press the Nav screen button to display a view of the map. Press the Destination screen button to go to the destination entry views.

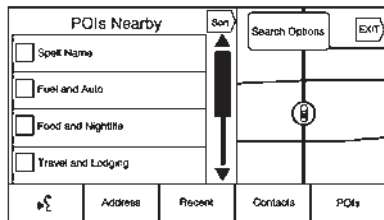

1. Press the POIs screen button to display a list of POI categories.

The first list item in every POI list is a search function. For the highest level of categories, press the Spell Name screen button or select a category and search within that selection.

2. Select a POI category to display subcategories.
3. If a selected subcategory has no results in the surrounding area, the search is expanded until a result is found.

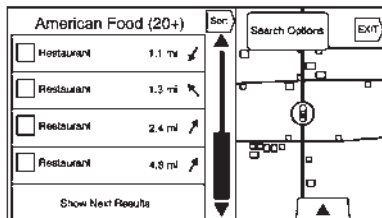

4. When a category is selected, the nearest locations are shown on the map and it lists the nearest

20 matches. If the limit is reached and no further matches display, there is a Show Next Results button to expand the search by another 10 results. The currently selected category or search term is shown in the title bar along with the number of matches shown in the list in parentheses.

5. Pan the map using the finger gestures to minimize the POI list and to interact with the map. The icons that were shown before continue to be displayed and updated. The list is also updated based on where the map was panned or zoomed. The search for POIs is constrained to where the map has been moved to. Press the list reveal button, which is the arrow pointing right, near the left edge of the screen, to display the list again.

6. If the search map is pressed to recenter, the crosshairs are shown to indicate the center of the new search location.

If a POI icon is pressed on while in the full expanded map, a callout for that location displays. Press the callout to display the destination details view.

- Press the map reset button to return the map to automatic zooming and searching. It is recentered around the vehicle's position, the route, the destination, or another location that was specified for the search. The map RESET button is only displayed if the map was manually adjusted.

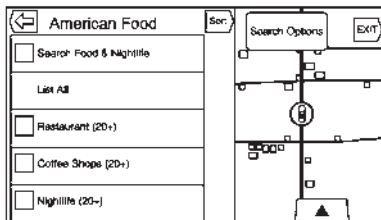

Press the List All screen button to display all of the matching results in a particular category with its subcategories.

### Using the Keyboard

The POI can be searched by entering a POI name, category, name and category, or phone number on the keyboard.

For example, enter the information as:

**POI Name:** Worldwide Food

**POI Category:** Restaurants

**POI Name and Category:**  
Worldwide Food Restaurants

**POI Phone Number:** 0001222555

Additionally, a location may be entered if the POI is not nearby. This search will then be made around the location that is given.

For example, enter the information as:

**POI Name and Location:**  
Worldwide Food Chicago IL

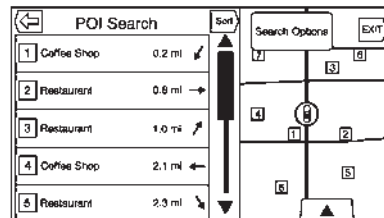

The POI keyboard search results will display in the order in which they were found. Press the Sort button to change the sorting order by Confidence, Alphabetical, or Distance.

## POI Search Location

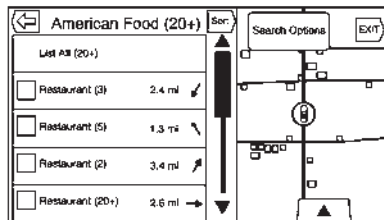

If browsing for POIs or searching for results on a keyboard in a different location than what was searched previously, press the Search Options button to specify a different location.

If not under route guidance, the search area options are:

- Nearby (default)
- Another Location

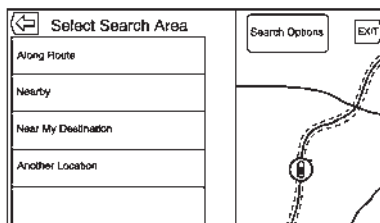

If under route guidance, the search area options are:

- Along Route (default)
- Nearby
- Near My Destination
- Another Location

### Favorite POIs

Locations, categories, or a particular POI chain ID can be saved as Favorites in the POIs view.

Press and drag up on the row of Interaction Selector buttons to reveal the Favorite buttons.

Press and hold on a favorite location, then press on the category to be saved. Whenever a set of POIs is grouped, as in a category or a set of POIs that all belong to the same chain ID, the whole category or chain ID is saved in the favorites for recall. Whenever a set of POIs that belong to the same chain ID is saved in the favorites, a POI chain saving pop-up message displays asking to save only that location, or to save the entire chain.

POIs are only grouped by chain when the sorting order is Alphabetical.

A POI search can also be saved as a favorite. While in the POI search keyboard view, press and hold on a favorite location and the text that is currently typed in the keyboard will be saved.

Press the Sort button to change the sorting order.

### Recalling a POI Category or Chain

If a POI category or chain favorite is recalled, the system displays a list of matching results defaulting to Nearby, but allows a search of other locations. Press the Search Options button to specify a different location.

### Creating and Downloading Predefined POIs (My POIs)

In addition to the POIs already stored in the infotainment system, predefined POIs can be created.

While creating a predefined POI, the GPS coordinates for longitude and latitude of the POI's location and a descriptive name will need to be entered.

After creating the predefined POIs, they can be downloaded to the infotainment system from either a USB stick or SD card.

Once downloaded, the POI data becomes a selectable destination in the My POIs menu.

### Creating a Text File with Information

Create a text file by using a simple text editor software. Save this file with a name and extension of .csv, for example, "TomsPOI.csv."

Enter the POI information into the text file in the following format:

- Longitude coordinate, Latitude coordinate, "Name of POI," "Additional information," "Phone number."

Example: 7.0350000,  
50.6318040, "Michaels Home,"  
"123 Maple Lane,"  
"02379234567."

- The GPS coordinates must be expressed in decimal degrees and can be taken from a geographical map. The additional information and phone number strings are optional.
- The POI name and the additional information string may not exceed 60 characters.

- POI information for each destination address must be entered in a single separate line.

### Storing the POI on a USB Drive

In the root directory of a USB drive, create a folder name "myPOIs"; for example, "F:\\" is the root directory of the USB drive.

In the "myPOIs" folder, store the text file with your POIs; for example, "F:\myPOIs\TomsPOIs.csv."

### Downloading the POI to the Infotainment System

Connect the USB drive or SD card containing the POI information to the USB port or SD card slot of the infotainment system. A message displays prompting whether or not to download the POI information from the USB stick. All POIs found are saved even if they are in multiple folders.

Subfolders can also be created to organize the POIs into categories; for example, "F:\myPOIs\Restaurants\TomsPOIs.csv."



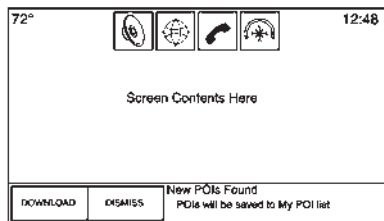

If the message is dismissed or ignored, no POI information is downloaded. This prompt will not reoccur for the current ignition cycle.

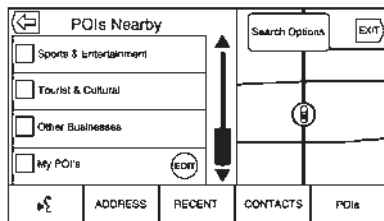

When the system is finished downloading, a pop-up displays asking to specify a category for the new POIs, if desired.

## Importing and Overwriting Categories

When POIs are found on a media device, the date of the file is examined and compared to the date for the files already in the system. If the file being downloaded is newer than the one in the system, that particular category of POIs is overwritten. Any other POIs that had previously been saved in other categories are not affected.

## Address Book Download

If an Address Book is found on the connected USB device, the same alert is used to indicate that locations have been found and they can be downloaded. If there is already content in the vehicle Address Book, the system prompts if the stored content should be overwritten. Select Save to overwrite the existing Address Book information. Select Cancel to abort the import of information.

## Browsing Downloaded POIs

Access the downloaded POIs by selecting the My POIs list item in the POIs list.

## Edit My POIs

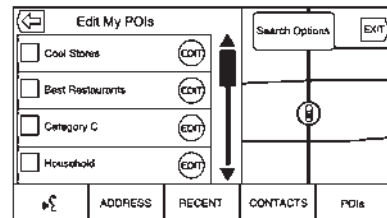

Downloaded POIs can be edited at a category level. These POIs can either be deleted as an entire category or reassigned as another category. To edit the categories:

- Select the EDIT button at the main category view to edit the POIs. EDIT buttons display next to each category name. There is no POI browsing in this mode; only edit functions are available.

- Once an action such as deleting or reassigning has been selected, the changes are saved immediately.

### Changing POI Categories

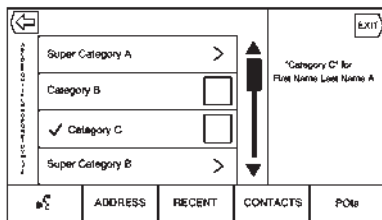

POI categories can be assigned to a different category by using the same method as assigning a category for an Address Book entry. When editing, the right side of the screen displays the current category name.

### Deleting POI

POI categories can be deleted by selecting Edit and then Delete. A pop-up displays to confirm the deletion.

### Saved Destinations

Select a saved destination from the Contacts or Recent Destinations.

### Contacts

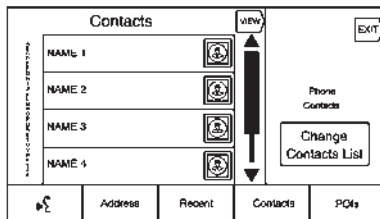

Select the Contacts button to view the vehicle's contact list or a connected Bluetooth device. Press the Change Contacts List screen button to switch between the vehicle's contact list and the Bluetooth device's contact list. If a particular contact has a single address associated with it, that contact has a Quick Route list item function button next to it. Contacts without this Quick Route button either have multiple addresses or no

address at all. Press the Quick Route button to go to the Destination Details view.

Press on an address, either from the Quick Route on the contact list or a specific address from the contact detail list, to go to the destination view showing that address on the map.

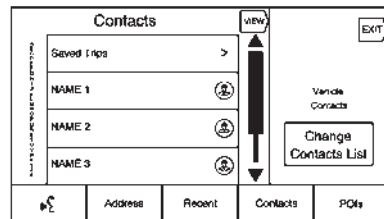

Trips from Contacts can be saved and recalled. The order is based on when the trip was last used. When the trips are saved, they are given a default title of the final destination name. If there are no saved trips, this list item is hidden.

## Favorite Destinations

- Destinations can be saved as Favorites for recall later. Depending on the favorite, when an address or POI favorite is recalled, the Destination Details View is shown.
- When a favorite address is being routed to, it is shown active. Press on the active favorite to suspend that route.
- Save locations as Favorites for recall later in the Destination Details View.
- Save trips from the Address Book.

## Storing Favorites from the Contact Details List

A contact name or any of the contact's information such as phone number, e-mail address, or address from Contact Details can be stored as a Favorite.

- Press and drag up on the row of Interaction Selector buttons to reveal the Favorite buttons.
- Press and hold on the favorite location while viewing a contact on the Contact Details List. The contact name and all contact information can be stored.
- Press to save as a favorite. The favorite label will be the name of the contact.
- Press on the Favorite to display the destination view.

## Storing Favorites from Map

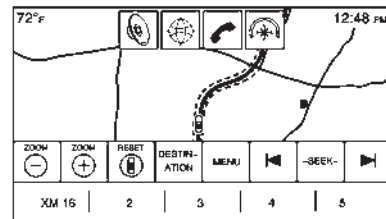

Favorite locations can be stored from the Map View.

If not under route guidance, the current vehicle location will be saved as a Favorite. If under route guidance, the final destination will be saved.

Press and drag up on the row of Interaction Selector buttons to reveal the Favorite buttons. Press and hold on the favorite location from the Map View to save it.

### Route Guidance

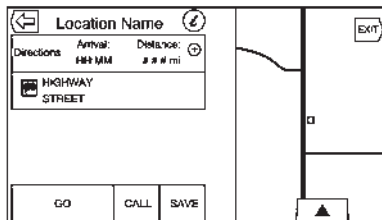

- Press GO to go to the main navigation view and to start route guidance.
- If the system has an active route, a pop-up will display, "What would you like to do with this destination?" The options are: Add As Waypoint, Set New Destination, or Cancel.
- If a waypoint is added, it is placed in the location that leads to the most efficient route.

- There is a maximum number of waypoints that can be added to the system. When the maximum number of waypoints has been reached, a pop-up displays indicating that a waypoint must first be deleted before a new one can be added. The system will hold this waypoint into a Pending Waypoints list and will automatically be added to the route once a position is available, either by arriving at a waypoint, or by deleting one.
- To save a location, tap on the ▲ to display the Favorite buttons. Press and hold on a favorite location to save the shown location as a Favorite.

### Estimated Time of Arrival (ETA) and Distance

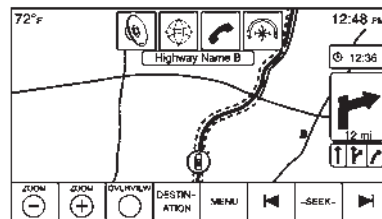

- When under route guidance, the system shows the ETA or travel time, or the driving distance.
- The ETA and travel time are calculated using any available traffic information.
- If in a waypoint trip, the ETA, travel time, and driving distance are all shown relative to the final destination.
- The final ETA is shown taking into consideration any time zone crossings that the route has traveled through.

- Press the ETA information area to switch between the estimated arrival time, total driving time resulting, and driving distance.

### Turn List

Press on the next turn indicator shown on the map to display the turn list or waypoint list. The Interaction Selector is minimized automatically. Press ▲ to reveal the following options:

### Destination

Press the Destination screen button to add a waypoint or change the destination while viewing the turn list. When the Destination screen button is pressed, the display shows the Destination screens.

### End Guidance

Press the End screen button to suspend the current route in the turn list. When the End screen button is pressed, the turn list is exited and the display returns to the main map view.

### Avoid Areas

Press the Avoid Areas screen button to select the highway name that is to be avoided. The system shows a pop-up asking how many miles or if the entire road should be avoided.

### Turn List

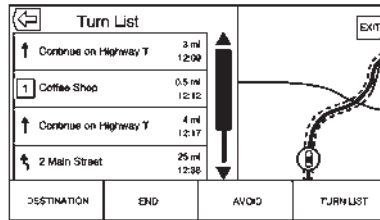

- When under a waypoint trip, press on the Turn List Interaction Selector button to show the turn list. When entering a turn list, the next maneuver instruction is spoken.
- The turn list title is the name or address of the destination. Press on the information button next to

the name of the destination to display the destination information.

- The turn list is sorted in order with the next maneuver at the top of the list and the subsequent maneuvers listed below it. The next maneuver is always highlighted upon entry into the Turn List to quickly show what the next maneuver is.
- Each maneuver indicates the distance between it and the previous maneuver or the vehicle's current location. The next maneuver at the top will count down until the maneuver is reached, and then the next maneuver will begin to count down.
- Each maneuver has an estimated time of arrival based on the current driving conditions.

## Saved Trips

Waypoint trips can be saved for later recall. Press the Add button in the waypoints list to save the trip to the Saved Trips list in the vehicle's contacts list. When trips are saved, they are given a default title of the final destination. Saved trips can be edited by selecting the Edit list item button. The only field that can be edited is the name field. Press on the name field to access the keyboard view. Type the name change. This change is automatically saved when executed by the keyboard.

The saved trip can also be deleted from the edit mode. Press the delete button and a delete confirmation pop-up will display.

## Waypoints

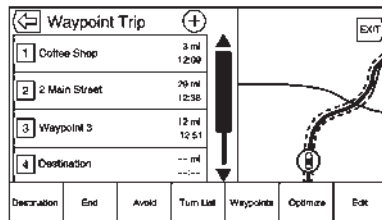

- When under a waypoint trip, press on the next turn indicator to bring up the waypoint list. The last waypoint view is shown, which could be Waypoints, Turn List, or Edit.
- The waypoint list is sorted in order with the next waypoint at the top of the list. Each waypoint is indicated with a numbered icon, starting with the next waypoint.
- To indicate what segment of the route is for the next waypoint, and what is for the remainder of the route, they appear in different colors.

## Optimized Route

- Press the Optimize screen button to optimize the current waypoint trip.
- The optimization is done according to how the preferences are set for new routes; for example, fastest route, shortest distance, or eco friendly.
- While the system is optimizing the route, the waypoint trip has the activity indicator displayed over top of it. If the system is calculating the ETA and travel distance for a waypoint, the activity indicator is displayed in the list header.
- When either a waypoint trip is first created, or additional waypoints are added to an existing waypoint trip, they are added in the location that would lead to an optimized route.

- If a destination is already planned and a waypoint is added, it is either added before or after the current destination, whichever leads to the most optimal route.
- If under an existing waypoint trip consisting of two or more destinations, any additional waypoints are added in the location that would lead to the most optimal route.

**Edit Route**

- Press the Edit screen button to modify the order or remove a waypoint from the route. Press the delete screen button to remove a waypoint from the route.
- A pop-up displays asking for confirmation of the waypoint deletion.

**OnStar® System**

With an OnStar® subscription, an OnStar Advisor can download a destination to the vehicle or into the built-in navigation system. If an OnStar Turn-by-Turn route is in progress, all other internal navigation functions are disabled until the route is completed.

When navigation is selected, the OnStar Turn-by-Turn screens display.

**Turn-by-Turn Navigation**

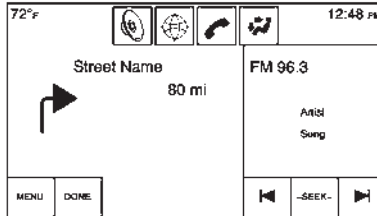

Press the MENU button to go to the Turn-by-Turn Menu.

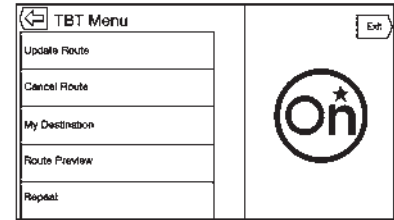

The following options display:

- Update Route (if the vehicle is off the route)
- Cancel Route
- My Destination
- Route Preview
- Repeat

**My Destination**

Select My Destination to display a special version of the Maneuver View. The Destination Address is displayed in the Street Name and the total distance to the destination is displayed in the Distance to

Maneuver View. Press the DONE button to return to the Maneuver View.

## Route Preview

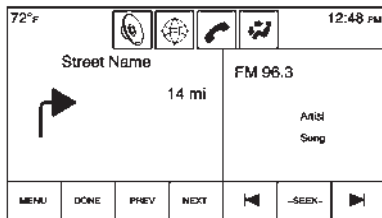

- Press Route Preview to display the Maneuver View.
- Press NEXT or PREVIOUS to display the next or previous maneuver information, including distance between it and the previous maneuver.
- Press the DONE button to return to the Maneuver View.

## Repeat

Select Repeat to go back to the Maneuver View and repeat the audible maneuver prompt.

## No Active Route



There is no active route if:

- The vehicle does not have a built-in navigation system and the navigation application is selected from the Home screen.
- If the system receives the indication that there is an active OnStar subscription, the help text is displayed with instructions on how to set up a route.

## Cancel a Route

If a route is in progress using either the vehicle navigation system or the OnStar Turn-by-Turn route, and a new route is requested, the current route in progress will be canceled.

An OnStar Advisor can cancel the vehicle navigation system route. Route guidance can be resumed by selecting the Resume To screen button in the Map Menu.

## Settings

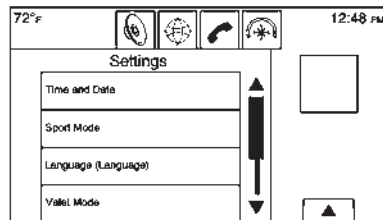

Press SETTINGS on the Home Page to adjust features and preferences, such as Time and



Date, Sport Mode, Language, Valet Mode, or Radio. For setting options, see *Settings on page 118*.

A few of the setting options change the way the navigation system displays or reacts while in use.

1. Press the SETTINGS screen button on the Home Page.
2. Press the scroll bar until the desired option displays. Select the desired settings to change.

## Voice

Voice recognition allows for hands-free operation within the navigation, audio, phone, and weather applications. See *Voice Recognition on page 100*.

Press the voice screen button to display the Voice menu.

**Prompt Length:** Press to change the prompt length to Short or Long.

**Audio Feedback Speed:** Press to change the audio feedback speed to Slow, Medium, or Fast.

**Confidence Threshold:** Press to change the sensitivity of the voice recognition system.

## Display

**Mode:** Press Mode to change the screen background. This setting controls map colors.

- The Auto setting adjusts the screen background automatically depending on the exterior lighting conditions.
- The Day setting brightens the map background.
- The Night setting darkens the map background.

**Calibrate Touchscreen:** Press to display the Touchscreen Calibration Screen.

**Turn Display Off:** Press to turn the Display option off.

## Low Fuel Alert

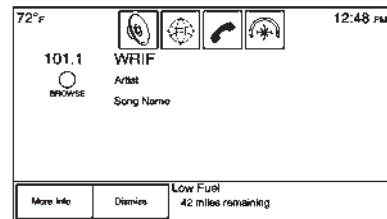

If the vehicle reaches a low fuel level, the system displays an alert about the low fuel condition. Press the More Info screen button to view nearby gas stations and start guidance, if desired.

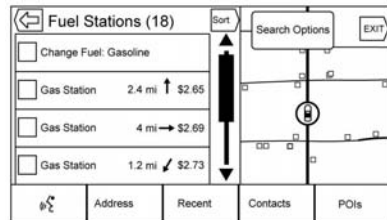

If the remaining driving distance is available from the system, this is included in the alert.

### Global Positioning System (GPS)

The position of the vehicle is determined by using satellite signals, various vehicle signals, and map data.

At times, other interference such as the satellite condition, road configuration, condition of the vehicle, and/or other circumstances can affect the navigation system's ability to determine the accurate position of the vehicle.

The GPS shows the current position of the vehicle using signals sent by GPS satellites. When the vehicle is not receiving signals from the satellites, a symbol appears on the map screen. See *Navigation Symbols on page 77*.

This system might not be available or interference can occur if any of the following are true:

- Signals are obstructed by tall buildings, trees, large trucks, or a tunnel.
- Satellites are being repaired or improved.

For more information if the GPS is not functioning properly, see *Problems with Route Guidance on page 99* and *If the System Needs Service on page 99*.

### Vehicle Positioning

At times, the position of the vehicle on the map could be inaccurate due to one or more of the following reasons:

- The road system has changed.
- The vehicle is driving on slippery road surfaces such as sand, gravel, or snow.

- The vehicle is traveling on winding roads or long, straight roads.
- The vehicle is approaching a tall building or a large vehicle.
- The surface streets run parallel to a freeway.
- The vehicle has been transferred by a vehicle carrier or a ferry.
- The current position calibration is set incorrectly.
- The vehicle is traveling at high speed.
- The vehicle changes directions more than once, or the vehicle is turning on a turn table in a parking lot.
- The vehicle is entering and/or exiting a parking lot, garage, or a lot with a roof.
- The GPS signal is not received.
- A roof carrier is installed on the vehicle.
- Tire chains have been installed.

- The tires are replaced or worn.
- The tire pressure for the tires is incorrect.
- This is the first navigation use after the map data is updated.
- The 12-volt battery has been disconnected for several days.
- The vehicle is driving in heavy traffic where driving is at low speeds, and the vehicle is stopped and started repeatedly.

## Problems with Route Guidance

Inappropriate route guidance can occur under one or more of the following conditions:

- The turn was not made on the road indicated.
- Route guidance might not be available when using automatic rerouting for the next right or left turn.

- The route might not be changed when using automatic rerouting.
- There is no route guidance when turning at an intersection.
- Plural names of places might be announced occasionally.
- It could take a long time to operate automatic rerouting during high-speed driving.
- Automatic rerouting might display a route returning to the set waypoint if heading for a destination without passing through a set waypoint.
- The route prohibits the entry of a vehicle due to a regulation by time or season or any other regulation which may be given.
- Some routes might not be searched.

- The route to the destination might not be shown if there are new roads, if roads have recently changed, or if certain roads are not listed in the map data. See *Maps on page 76*.

To recalibrate the vehicle's position on the map, park with the vehicle running for two to five minutes, until the vehicle position updates. Make sure the vehicle is parked in a location that is safe and has a clear view of the sky and away from large obstructions.

## If the System Needs Service

If the navigation system needs service and the steps listed here have been followed but there are still problems, see *Problems with Route Guidance on page 99*.

## Map Data Updates

The map data in the vehicle is the most up-to-date information available when the vehicle was produced. The map data is updated periodically, provided that the map information has changed.



For questions about the operation of the navigation system or the update process, contact the GM Nav Disc Center toll-free phone number, 1-877-NAV-DISC (1-877-628-3472) or go to the center's website, [www.gmnavdisc.com](http://www.gmnavdisc.com). If updates are needed, call the GM Nav Disc Center or order online.

To order, have the vehicle's Vehicle Identification Number (VIN) available. This helps the center make sure that the correct and most up-to-date map data for the vehicle is received. See "Vehicle Identification Number (VIN)" in the owner manual.

## Database Coverage Explanations

Coverage areas vary with respect to the level of map detail available for any given area. Some areas feature greater levels of detail than others. If this happens, it does not mean there is a problem with the system. As the map data is updated, more detail can become available for areas that previously had limited detail. See *Map Data Updates on page 100*.

## Voice Recognition

Voice recognition allows for hands-free operation within the navigation, audio, phone, and weather applications. This feature can be started by pressing either the  button on the steering wheel or  on the touchscreen display.

However, not all features within these areas are supported by voice commands. Generally, only complex tasks that require multiple manual interactions to complete are supported by voice commands.



For example, tasks that take more than one or two button presses such as selecting a song or artist to play from a media device would be supported by voice commands. Other tasks, like adjusting the volume or seeking up or down, are audio features that are easily performed by pressing one or two buttons, and are not supported by voice commands.

In general there are flexible ways to speak commands for completing the tasks. Most of them, except destination entry and voice keypad, can be completed in a single command. If the task takes more than one command to complete, the first command would be to indicate the kind of task to be performed, like “NavigationDestination Entry.” The system replies with prompts that lead you through a dialog to enter the necessary information. For example, if a destination for route guidance is needed, say “Navigation” or “Destination Entry.”

Voice recognition can be used when the ignition is on or when Retained Accessory Power (RAP) is active. See “Retained Accessory Power (RAP)” in the owner manual.

### Using Voice Recognition

Voice recognition becomes available once the system has been initialized. This begins when the ignition is turned on. Initialization may take a few moments.

1. Press  on the steering wheel control to activate voice recognition, or press  on the infotainment touchscreen on the center stack.
  - If voice recognition is started from the steering wheel control, the instrument cluster displays the selections and visual dialog content.
  - If voice recognition is started from the infotainment touchscreen, the selections and visual dialog content are displayed on both the center stack display and the instrument cluster display.

2. The audio system mutes and the system plays a prompt followed by a beep.
3. Wait until after the beep completes, then clearly speak one of the commands described in this section.

A voice recognition system prompt can be interrupted while it is playing by pressing  again.

For example, if the prompt seems to be taking too long to finish, press  again and the beep should happen right away.

There are two voice prompt modes supported:

- Long verbal prompts: The longer prompts provide more information regarding the supported actions.
- Short prompts: The short prompts provide simple instructions about what can be stated.

If a command is not spoken, the voice recognition system says a help prompt.

### Prompts and Screen Displays

While a voice recognition session is active, there will be corresponding buttons on screens displayed. Manual interaction in the voice recognition session is permitted. Interaction during a voice session may be completed entirely using voice commands, or some selections may expedite a session. If a selection is made using a manual control, the dialog will progress in the same way as if the selection was made through a voice command. Once the system is able to complete the task, or the session is terminated, the voice recognition dialog stops.

An example of this type of manual intervention is pressing on an entry of a displayed number list instead of speaking the number associated with the entry desired.

### Canceling Voice Recognition

- Press the Home screen button. Pressing this button will terminate the voice recognition session.
- Press or say “Cancel” or “Exit” to terminate the voice recognition session and display the screen from which voice recognition was initiated.
- Press  on the steering wheel controls to terminate the voice session and display the screen from which voice recognition was initiated.

Most languages do not support natural language commands in sentence form. For those languages, use direct commands like the examples shown on the display.

### Helpful Hints for Speaking Commands

Voice recognition can understand commands that are either naturally stated in sentence form or direct commands that state the application and the task.

For best results:

- Listen for the prompt and wait for the beep before saying a command or reply.
- Say “Help” or look at the screen display for example commands.
- A voice recognition system prompt can be interrupted while it is playing by pressing  again.

For example, if the prompt seems to be taking too long to finish, to speak the command without waiting for the prompt to complete, press  again and wait for the beep.

- Speak the command naturally, not too fast, not too slow. Use direct commands without a lot of extra words.
- Usually Phone and Audio commands can be spoken in a single command.

For example, “Call Dave Smith at work,” “Play” followed by the artist or song name, or “Tune” followed by the radio station number.

- Navigation destinations are too complex for a single command. First, state a command that explains the type of destination needed, such as I want directions to an “Address,” “Navigate to an intersection,” “I need to find a Place of Interest or POI,” or “Directions to a Contact.” The system responds with requesting more details. After saying “Place of Interest,” only major chains are available by name. Chains are businesses with at least 20 locations.

For other POIs, say the name of a category like “Restaurants,” “Shopping Malls,” or “Hospitals.”

Most languages do not support natural language commands in sentence form. For those languages, use direct commands like the examples shown on the display.

There is no need to memorize specific command words. Direct commands might be more clearly understood by the system. An example of a direct command would be “Call 555-1212.” Examples of these direct commands are displayed on most of the screens while a voice session is active. If “Phone” or “Phone Commands,” is stated, the system understands that a phone call is requested and will respond with questions until enough details are gathered.

If the phone number has been saved with a name and a place, the direct command should include both, for example “Call Dave Smith at work.”

### Using Voice Recognition for List Options

When a list is displayed, a voice prompt will ask to confirm or select an option from that list. A selection can be made by manually selecting the item, or by speaking the line number for the item to select.

When a screen contains a list, there may be options that are available but not displayed. The list on a voice recognition screen functions the same as a list on other screens. Scrolling or flinging can be used to help display other entries from the list.

Manually scrolling or paging the list on a screen during a voice recognition session suspends the current voice recognition event and plays the prompt “Make your

selection from the list using the manual controls, press the Back screen button to try again.”

If manual selection takes more than 15 seconds, the session terminates and prompts that it has timed out. The screen returns back to the screen where voice recognition was initiated.

### The Back Command

Say “Back” or press the Back screen button to go to the previous screen.

If in voice recognition, and “Back” is stated all the way through to the initial screen, then “Back” is stated one more time, the voice recognition session will cancel.

### Help

Say “Help” on any voice recognition screen and the help prompt for the screen is played. Additionally, a pop-up displays a text version of the help prompt. Depending on how voice recognition was initiated, the Help pop-up will either display on

the instrument cluster or the infotainment touchscreen. Press the Dismiss button to make the pop-up go away.

Pressing  $\mathbb{W}$  while the help prompt is playing will terminate the prompt and a beep will be heard. Doing this will stop the help prompt so that a voice command can be used.

### Voice Recognition for the Radio

All audio screens have a voice recognition button ( $\mathbb{W}$ ) to launch audio voice recognition. If the voice button is pressed in a radio screen, the voice commands for radio and media features are available.

**“Switch to AM”:** Switch bands to AM and tune to the last AM radio station.

**“Switch to FM”:** Switch bands to FM and tune to the last FM radio station.

**“Switch to XM”:** Switch bands to SiriusXM and tune to the last SiriusXM channel.

**“Tune to <AM frequency> AM”:** Tune to the radio station whose frequency is identified in the command (like “nine fifty”).

**“Tune to <FM frequency> FM”:** Tune to the radio station whose frequency is identified in the command (like “one oh one point one”).

**“Tune to <AM frequency> AM HD”:** Tune to the HD Radio station whose frequency is identified in the command.

**“Tune to <FM frequency> FM HD”:** Tune to the HD Radio station whose frequency is identified in the command.

**“Tune to <FM frequency> FM HD <HD channel number>”:** Tune to the HD Radio station whose frequency and HD channel is identified in the command.



**“Tune to XM <XM channel number>”:** Tune to the SiriusXM radio station whose channel number is identified in the command.

**“Tune to XM <XM channel name>”:** Tune to the SiriusXM radio station whose channel name is identified in the command.

### Voice Recognition for Audio My Media

If browsing My Media when the voice button is selected, the voice recognition commands for My Media features are available.

**“Play Artist”:** Begin a dialog to enter a specific artist name.

**“Play Artist <artist name>”:** Begin playback of the media selection identified in the command.

**“Play Album”:** Begin a dialog to enter a specific album name.

**“Play Album <album name>”:** Begin playback of the identified album name in the command.

**“Play Song”:** Begin a dialog to enter a specific song name.

**“Play Song <song name>”:** Begin playback of the identified song name in the command.

**“Play Genre”:** Begin a dialog to enter a specific genre.

**“Play Genre <genre name>”:** Begin playback of the media selection identified in the command.

**“Play Playlist”:** Begin a dialog to enter a specific playlist name.

**“Play Playlist <playlist name>”:** Begin playback of the identified playlist in the command.

**“Play <device name>”:** Play music from a specific device identified by name. The device name is the name displayed on the screen when the device is first selected as an audio source.

**“Play Chapter”:** Begin a dialog to enter a specific name.

**“Play Chapter <chapter name>”:** Begin playback of the media selection identified in the command.

**“Play Audiobook”:** Begin a dialog to enter a specific name.

**“Play Audiobook <audiobook name>”:** Begin playback of the media selection identified in the command.

**“Play CD Track <track number>”:** Begin playback of the CD at the track identified in the command.

**“Play Episode”:** Begin a dialog to enter a specific name.

**“Play Episode <episode name>”:** Begin playback of the media selection identified in the command.

**“Play Podcast”:** Begin a dialog to enter a specific name.

**“Play Podcast <podcast name>”:** Begin playback of the media selection identified in the command.

**“Play Video”:** Begin a dialog to enter a specific name.

**“Play Video <video name>”:**

Begin playback of the media selection identified in the command.

**“My Media”:** Begin a dialog to enter the desired media content.

### Handling Large Amounts of Media Content

It is expected that large amounts of media content will be brought into the vehicle. It may be necessary to handle large amounts of media content in a different way than smaller amounts of media. The system may limit the options of voice recognition by not allowing selection of song titles by voice at the highest level if the number of songs exceeds the maximum limit.

Voice command option changes through media content limits are:

- Song files including other individual files of all media types such as audiobook chapters, podcast episodes, and videos.

- Album type folders including types such as albums and audiobooks.

There are no restrictions if the number of song files and albums is less than 4,000. When the number of song files connected to the system is between 4,000 and 8,000, the content cannot be accessed directly with one command like “Play <song name>.”

The restriction is that the command “Play Song” must be spoken first; the system will then ask for the song name. The reply command would be to say the name of the song to play.

Similar limits exist for album content. If there are more than 4,000 albums, but less than 8,000, the content cannot be accessed directly with one command like, “Play <album name>.” The command “Play Album” must first be spoken; the system will then ask for the album name. The reply would be to say the name of the album to play.

Once the number of songs has exceeded approximately 8,000, there is no support for accessing the songs directly through voice commands. There will still be access to the media content by using commands for playlists, artists, and genres.

The access commands for playlists, artists, and genres are prohibited after the number of this type of media exceeds 4,000.

The system will provide feedback the first time voice recognition is initiated if it has become apparent that any of these limits are reached during a device initializing process.

### Voice Recognition for Navigation

**“Navigation”:** Begin a dialog to enter specific destination information.

**“Navigation Commands”:** Begin a dialog to enter specific destination information.

**“Destination Address”:** Begin a dialog to enter a specific destination address, which includes the entire address consisting of the house number, street name, and city and state.

**“Destination Intersection”:** Begin a dialog to enter a specific destination intersection.

**“Destination Place of Interest”:** Begin a dialog to enter a destination Place of Interest category or major brand name (if equipped).

Not all brand names of businesses are available for voice entry. Most major chains, such as chains with more than 20 locations, should be available to search for by name, but the name must be precisely spoken. Nicknames or short names for the businesses will not likely be found. Lesser known businesses might have to be located by category, such as fast food, hotels, or banks.

**“Destination Contact”:** Begin a dialog to enter a specific destination contact name.

**“Cancel Route”:** End route guidance.

### Voice Recognition for the Phone

**“Call <contact name>”:** Initiate a call to an entered contact. The command may include location if the contact has location numbers stored.

**“CallAt Home <contact name> ,” “At Work,” “On Mobile,” or “On Other”:** Initiate a call to an entered contact and location at home, at work, on mobile device, or on another phone.

**“Call <phone number>”:** Initiate a call to a standard phone number seven or 10 digits in length, and also 911, 411, or 611.

**“Pair Phone”:** Begin the Bluetooth pairing process. Follow instructions on the radio display.

**“Redial”:** Initiate a call to the last dialed number.

**“Switch Phone”:** Select a different phone for outgoing calls.

**“Voice Keypad”:** Begin a dialog to enter special numbers like international numbers. The numbers can be entered in groups of digits with each group of digits being repeated back by the system. If the group of digits is not correct, the command “Delete” will remove the last group of digits and allow them to be re-entered. Once the entire number has been entered, the command “Call” will start dialing the number.

**“Voice mail”:** Initiate a call to voice mail numbers.

### Voice Pass-Thru

Voice pass-thru/Siri® Eyes Free allows access to the voice recognition commands on the cell phone, for example, Siri or Voice Command. See the cell phone manufacturer's user guide to see whether the cell phone supports this feature.

To activate the phone voice recognition system, press and hold  on the steering wheel for a few seconds.

This enhances the normal use of Siri. Siri allows access to text messages, calendars, and audio sources such as Pandora or iTunes.

### **Voice Recognition for OnStar (If Equipped)**

“**OnStar**”: Begin OnStar Voice Recognition.

### **Voice Recognition for Weather (If Equipped)**

“**Weather**”: Begin a dialog to enter a weather location.

## **Phone**

### **Bluetooth (Overview)**

The Bluetooth-capable system can interact with many cell phones, allowing:

- Placement and receipt of calls in a hands-free mode.
- Sharing of the cell phone’s address book or contact list with the vehicle.

To minimize driver distraction, before driving, and with the vehicle parked:

- Become familiar with the features of the cell phone. Organize the phone book and contact lists clearly and delete duplicate or rarely used entries. If possible, program speed dial or other shortcuts.
- Review the controls and operation of the infotainment system.

- Pair cell phone(s) to the vehicle. The system may not work with all cell phones. See “Pairing” in this section.

Vehicles with a Bluetooth system can use a Bluetooth-capable cell phone with a Hands-Free Profile to make and receive phone calls. The infotainment system and voice recognition are used to control the system. The system can be used while in ON/RUN or ACC/ACCESSORY. The range of the Bluetooth system can be up to 9.1 m (30 ft). Not all phones support all functions and not all phones work with the Bluetooth system. See [www.gm.com/bluetooth](http://www.gm.com/bluetooth) for more information about compatible phones.

### **Controls**

Use the buttons on the infotainment system and the steering wheel to operate the Bluetooth system.

### Steering Wheel Controls

 **(Push to Talk):** Press to answer incoming calls and start voice recognition.

 **(End Call):** Press to end a call, decline a call, or cancel an operation. Press to mute or unmute the infotainment system when not on a call.

### Infotainment System Controls

For information about how to navigate the menu system using the infotainment controls, see *Infotainment on page 3*.

**PHONE:** Press this screen button to enter the phone main menu.

### Audio System

When using the Bluetooth phone system, sound comes through the vehicle's front audio system speakers and overrides the audio system. Press just above the chrome volume bar during a call to change the volume level. The

adjusted volume level remains in memory for later calls. The system maintains a minimum volume level.

### Bluetooth (Infotainment Controls)

For information about how to navigate the menu system using the infotainment controls, see *Infotainment on page 3*.

#### Pairing

A Bluetooth-enabled cell phone must be paired to the Bluetooth system and then connected to the vehicle before it can be used. See the cell phone manufacturer's user guide for Bluetooth functions before pairing the cell phone.

#### Pairing Information

- A Bluetooth phone with music capability can be paired to the vehicle as a phone and a music player at the same time.
- Up to 10 devices can be paired to the Bluetooth system.

- The pairing process is disabled when the vehicle is moving.
- Pairing only needs to be completed once, unless the pairing information on the cell phone changes or the cell phone is deleted from the system.
- If multiple paired cell phones are within range of the system, the system connects to the paired cell phone in the order that they were last used in the system. To link to a different paired phone, see "Linking to a Different Phone" later in this section.

#### Pairing a Phone

1. Press the PHONE screen button.
2. Select PHONES and select Pair Device.
3. A four-digit Personal Identification Number (PIN) appears on the display. The PIN, if required, may be used in Step 5.

4. Start the pairing process on the cell phone to be paired to the vehicle. See the cell phone manufacturer's user guide for information on this process.
5. Locate "Cadillac CUE" on the display. Follow the instructions provided in Step 3 on the cell phone to enter the PIN or confirm the six-digit code shown on the display. After the PIN is successfully entered or the code is confirmed, the system responds with "<Device name> has been successfully paired" when the pairing process is complete.
6. If "Cadillac CUE" does not appear, turn the phone off or remove the phone battery and retry.
7. If the phone prompts to accept connection or allow phone book download, select Always Accept and Allow. The phone book may not be available if not accepted.

8. Repeat Steps 1–7 to pair additional phones.

#### **Listing All Paired and Connected Phones**

1. Press the PHONE screen button.
2. Select PHONES.

#### **Disconnecting a Connected Phone**

1. Press the PHONE screen button.
2. Select PHONES.
3. Press the **X** next to the phone to disconnect.

#### **Deleting a Paired Phone**

Only disconnected phones can be deleted.

1. Press the PHONE screen button.
2. Select PHONES.
3. Press the **⊖** next to the phone to delete and follow the on screen prompts.

#### **Linking to a Different Phone**

To link to a different phone, the new phone must be in the vehicle and paired to the Bluetooth system.

1. Press the PHONE screen button.
2. Select PHONES.
3. Select the new phone to link to from the not connected device list.

#### **Switching to Handset or Handsfree Mode**

To switch between handset or handsfree mode, press the PHONE icon on the Home Page to display "Call View."

- While the active call is hands-free, press the Handset screen button to switch to the handset mode. The screen button changes to Handsfree once the Bluetooth device confirms it is operating as handset.

- While the active call is on the handset, press the Handsfree screen button to switch to the hands-free mode. The screen button changes to Handset once the Bluetooth device confirms it is operating as hands-free.

### **Making a Call Using Contacts and Recent Calls**

Calls can be made through the Bluetooth system using personal cell phone contact information for all phones that support the Phone Book feature. Become familiar with the phone settings and operation. Verify the cell phone supports this feature.

When supported, the Contacts and Recent Calls menus are automatically available.

The Contacts menu accesses the phone book stored in the cell phone.

The Recent Calls menu accesses the recent call list(s) from your cell phone.

To make a call using the Contacts menu:

1. Press the PHONE screen button.
2. Select CONTACTS.
3. Select the name to call.
4. Select the desired contact number to call.

To make a call using the Recent Calls menu:

1. Press the PHONE screen button.
2. Select RECENT.
3. Select the name or number to call.
4. If necessary, select between Missed, Recent, and Sent calls by selecting the View button in the top right corner of the list.

### **Making a Call Using the Keypad**

To make a call by dialing the numbers:

1. Press the PHONE screen button.
2. Select KEYPAD and enter a phone number.
3. Select Call to start dialing the number.

### **Accepting or Declining a Call**

When an incoming call is received, the infotainment system mutes and a ring tone is heard in the vehicle.

#### **Accepting a Call**

There are three ways to accept a call:

- Press  on the steering wheel controls.
- Press Answer on the center stack display.
- Press Answer on the instrument cluster using the select button.

### Declining a Call

There are three ways to decline a call:

- Press  on the steering wheel controls.
- Press Ignore on the center stack display.
- Press Ignore on the instrument cluster using the select button.

### Call Waiting

Call waiting must be supported on the Bluetooth phone and enabled by the wireless service carrier to work.

### Accepting a Call

There are three ways to accept a call-waiting call:

- Press  on the steering wheel controls.
- Press Switch on the center stack display.
- Press Switch on the instrument cluster using the select button.

### Declining a Call

There are three ways to decline a call-waiting call:

- Press  on the steering wheel controls.
- Press Ignore on the center stack display.
- Press Ignore on the instrument cluster using the select button.

### Switching Between Calls (Call Waiting Calls Only)

To switch between calls, press the phone icon on the Home Page to display “Call View.” While in Call View, press the call information of the call on hold to change calls.

### Three-Way Calling

Three-way calling must be supported on the Bluetooth phone and enabled by the wireless service carrier to work.

To start a three-way call while in a current call:

1. In the Call View, select Add to add another call.
2. Initiate the second call by selecting from RECENT, CONTACTS, or KEYPAD.
3. When the second call is active, press the merge icon to conference the three-way call together.
4. Once all calls are merged, the merge icon button becomes an unmerge icon button. Press to unmerge the calls.

Some wireless service carriers may not allow a merged call to become unmerged.

### Ending a Call

- Press  on the steering wheel controls.
- Press End on the center stack display to end all existing calls, or press End next to a call to end only that call.



- Press End on the instrument cluster using the select button.

### Dual Tone Multi-Frequency (DTMF) Tones

The in-vehicle Bluetooth system can send numbers during a call. This is used when calling a menu-driven phone system.

1. Press the PHONE screen button.
2. While in the Call View, press the up arrow to raise the Interaction Selector.
3. Select KEYPAD and enter the number.

### Voice Mail

The default voice mail number is the phone number of the outgoing phone source. The voice mail number can be changed in Bluetooth settings.

To dial a voice mail number:

1. Press the PHONE screen button.

2. Select VOICE MAIL.
3. Select Call.
4. Enter the DTMF tones using the keypad if needed.

## Bluetooth (Voice Recognition)

### Using Bluetooth Voice Recognition

To use voice recognition, press the  button on the steering wheel. Use the commands below for the various voice features. For additional information, say “Help” while in a voice recognition menu. See *Voice Recognition on page 100* for help using voice recognition commands.

### Making a Call

Calls can be made using the following commands.

### Using the “Dial” or “Call” Command

To call a number:

1. Press . The system responds “Command Please,” followed by a tone.
2. Say “Dial” or “Call” followed by the complete phone number.

Use the “Voice Keypad” command for international numbers or special numbers which include \* or #.

Once connected, the person called will be heard through the audio speakers.

To call using a contact from your phone book:

1. Press . The system responds “Command Please,” followed by a tone.
2. Say “Dial” or “Call” and then say the contact name. For example, say “Call John at Work.”

Once connected, the person called will be heard through the audio speakers.

### Calling 911 Emergency

1. Press . The system responds “Command Please,” followed by a tone.
2. Say “Call 911.”

Once connected, the person called will be heard through the audio speakers.

### Using the “Switch Phone” Command

1. Press . The system responds “Command Please,” followed by a tone.
2. After the tone, say “Switch Phone.” The system displays a list of phones to select.

### Using the “Voice Keypad” Command

1. Press . The system responds “Command Please,” followed by a tone.
2. After the tone, say “Voice Keypad.” The system allows entry of special numbers and characters.

### Using the “Voice Mail” Command

1. Press . The system responds “Command Please,” followed by a tone.
2. After the tone, say “Voice mail.” The system dials the voice mail number of the connected phone.

### Clearing the System

Unless information is deleted out of the vehicle Bluetooth system, it will be retained. This includes phone pairing information. For directions on how to delete this information, see “Deleting a Paired Phone.”

### Text Messaging

If equipped, the infotainment system may allow text messages to be received and replied to. Received messages can also be read aloud.

#### Text Menu

**Inbox:** Press to display incoming messages. To view a message, press on the name of the sender. Press to listen to the text message. Press the Back screen button to go back to the previous menu.

**Settings:** See “Text Settings” later in this section.

**Reply:** Press to reply using a predefined text message. See “Text Settings.”

**Call:** Press to place a call to the sender of the text message.

## Viewing a Text Message

While viewing a text message:

- Press Reply to reply using a predefined text message.
- Press Call to place a call to the sender of the text message.

## Viewing Sender Information

If equipped, press the name of the sender to view sender information if this information matches contact information already stored.

### Select a Predefined Message:

Press to select from a set of quick messages. Press the message to send.

## Predefined Messages

These are short text messages that can be used to send so responses will not have to be typed.

The messages can be deleted or a new message can be added.

To add a new message:

1. Press Text Settings, then press Manage Predefined Messages.
2. While in the predefined messages list view, select Add New Predefined Message and a keyboard displays.
3. Type a new message and press NEW MSG when done to add the message. Press the  Back screen button to go back to the predefined messages list. Press **X** to delete one character at a time.

## Memory Full

This message may display if there is no more room on the phone to store messages.

## Text Settings

**Text Alerts:** When on, this feature will display an alert when a new text message has been received. Press to turn on or off.

## Manage Predefined Messages:

Press to add, change, or delete predefined messages.

## Wireless Charging (Escalade)

The vehicle may have dockspot wireless charging on top of the center console. See “Floor Console Storage” in the owner manual. The system wirelessly charges one PMA or Qi compatible mobile device. To check for phone or other device compatibility, see [www.gmttotalconnect.com](http://www.gmttotalconnect.com).

The vehicle must be in ON/RUN, ACC/ACCESSORY, or Retained Accessory Power (RAP). The wireless charging feature may not correctly indicate charging when the vehicle is in RAP. See “Retained Accessory Power (RAP)” in the owner manual.



The operating temperature is -20°C (-4°F) to 60°C (140°F) for the charging system and 0°C (32°F) to 35°C (95°F) for the phone.

**Warning**

Remove all metal objects from charging pad before charging your mobile device. Metal objects, such as coins, keys, rings, or paper clips, between phone and charging pad will become very hot. On the rare occasion that the charging system does not detect a metal object, and the object gets wedged between phone and charger, remove the phone and allow the metallic object to cool before removing it from the charging pad, to prevent burns.



To charge a mobile device:

1. Remove all objects from the charging pad. The system may not charge if there are any objects on the charging pad.
2. Place the mobile device face up on the  symbol on the charging pad.
3. Move the mobile device slowly until  displays on the  on the infotainment screen. This indicates that the mobile device is properly positioned and charging.

**Wireless Charging (Except Escalade)**

The vehicle may have dockspot wireless charging in the storage behind the climate control system. See “Instrument Panel Storage” in the owner manual. The system wirelessly charges one PMA or Qi compatible mobile device. To check for phone or other device compatibility, see [www.gmtotalconnect.com](http://www.gmtotalconnect.com).

The vehicle must be in ON/RUN, ACC/ACCESSORY, or Retained Accessory Power (RAP). The wireless charging feature may not correctly indicate charging when the vehicle is in RAP. See “Retained Accessory Power (RAP)” in the owner manual.

The operating temperature is -20°C (-4°F) to 60°C (140°F) for the charging system and 0°C (32°F) to 35°C (95°F) for the phone.



**Warning**

Remove all metal objects from charging pad before charging your mobile device. Metal objects, such as coins, keys, rings, or paper clips, between phone and charging pad will become very hot. On the rare occasion that the charging system does not detect a metal object, and the object gets wedged between phone and charger, remove the phone and allow the metallic object to cool before removing it from the charging pad, to prevent burns.



To charge a mobile device:

1. Open the climate control system panel.

2. Remove all objects from the charging pad. The system may not charge if there are any objects on the charging pad.
3. Place the mobile device face up on the  symbol on the charging pad.
4. Move the mobile device slowly until  displays on the  on the infotainment screen. This indicates that the mobile device is properly positioned and charging.

Keep the storage door closed while driving.

## Settings

The Settings menu allows adjustment of different vehicle and radio features. The menu may contain the following:

### Time and Date

See “Clock” in the owner manual.

### Language

This will set the display language in the radio, instrument cluster, and voice recognition. Press Language and select the appropriate language. Press the ⏪ Back screen button to go back to the previous menu.

### Valet Mode (If Equipped)

This will lock the infotainment system and steering wheel controls. It may also limit top speed, power, and access to vehicle storage locations (if equipped).

To enable valet mode:

1. Enter a four-digit code on the keypad.
2. Press Enter to go to the confirmation screen.
3. Re-enter the four-digit code.

Press LOCK or UNLOCK to lock or unlock the system. Press ⏪ Back to go back to the previous menu.

### Radio

Press to display the Radio Menu and the following may display:

- **Manage Favorites:** Press a displayed Favorite to select that favorite to edit. Press Rename to rename the favorite or Delete to delete it. Press and hold the station to drag it to a new location. Press Done to go back to the previous menu.
- **Number of Favorites Shown:** Press to set the number of favorites to display. Select Auto, 5, 10, 15, 20, 25, 30, 35, 40, 45, 50, 55, or 60. Auto will

automatically add or hide additional Favorite pages based on the number of Favorites stored. Press the ⏪ Back screen button to go back to the previous menu.

- **Auto Volume:** If equipped, this feature adjusts the volume based on the vehicle speed. See *AM-FM Radio on page 11*.
- **Bose AudioPilot Noise Compensation Technology:** If equipped, this feature adjusts the volume based on the noise in the vehicle. See *AM-FM Radio on page 11*.
- **Maximum Startup Volume:** This feature sets the maximum startup volume. If the vehicle is started and the volume is greater than this level, the volume is adjusted to this level. To set the maximum startup volume, press + or – to increase or decrease. Press the ⏪ Back screen button to go back to the previous menu.

- **Audio Cue Volume (If Equipped):** This feature adjusts the startup and shutdown sounds. To adjust the volume, press + or – to increase or decrease. This feature can be turned on or off. Press the ⏪ Back screen button to go back to the previous menu.

## Vehicle Settings

See “Vehicle Personalization” in the owner manual.

## Bluetooth

From the Bluetooth screen button, the following may be displayed:

- **Pair New Device:** Press to add a new device.
- **Device Management:** Press to connect to a different phone source, disconnect a phone, or delete a phone.
- **Ringtones:** Press to change the ring tone for the specific phone. The phone does not need to be connected to change the ring tone.

- **Voice Mail Numbers:** This feature displays the voice mail number for all connected phones. The voice mail number may be changed by pressing the EDIT button, typing in the new number, and pressing SAVE. Press the ⏪ Back screen button to go back to the previous menu.
- **Text Message Alerts (If Equipped):** This feature will turn text message alerts on or off. Press Text Message Alerts and then select OFF or ON. Press the ⏪ Back screen button to go back to the previous menu. See *Text Messaging on page 114*.

## Voice

From the Voice screen button, the following may be displayed:

- **Confidence Threshold:** Select Confirm More or Confirm Less for the system to confirm more or less before acting on a command.

- **Prompt Length:** Select Short or Long for shorter or longer voice prompts that are played during voice recognition sessions. Press the ⏪ Back screen button to go to the previous menu.
- **Audio Feedback Speed:** Press Slow, Medium, or Fast for feedback speed. Press the ⏪ Back screen button to go back to the previous menu.

## Display

From the Display screen button, the following may be displayed:

- **Mode:** Press Auto, Day, or Night to adjust the display. Press the ⏪ Back screen button to go to the previous menu.
- **Calibrate Touchscreen:** Press to calibrate the touchscreen and follow the prompts. Press the ⏪ Back screen button to go back to the previous menu.

- Turn Display Off: Press to turn the display off. Press anywhere on the display area or any faceplate button again to turn the display on.

### Rear Camera



Press to display the Rear Camera menu. See “Driver Assistance Systems” in the owner manual.

### Return to Factory Settings

Pressing Continue restores all factory settings.

Select Return to Factory Settings and the following list may display:

- Restore Vehicle Settings: Restores factory vehicle personalization settings. Press Restore Vehicle Settings. Press Cancel or Continue. Press the  Back screen button to go back to the last menu.

- Clear All Private Data: Clears all private information. Press Clear All Private Data. Press Cancel or Continue. Press the  Back screen button to go back to the last menu.
- Restore Radio Settings: Restores factory radio settings. Press Restore Radio Settings. Press Cancel or Continue. A confirmation pop-up will appear indicating the radio settings have been restored if Continue is pressed. Press the  Back screen button to go back to the last menu.

### English and Metric Unit Conversion

To change the display units between English and metric units, see “Instrument Cluster” in the owner manual.

### Teen Driver

If equipped, Teen Driver allows keys to be programmed with customizable vehicle settings. It limits some vehicle features and prevents some systems, such as Park Assist, if equipped, from being turned off. It also displays a Report Card of the driving behavior when a Teen Driver key is used.

To activate or change the settings, select Teen Driver from the Settings menu. See “Vehicle Personalization” in the owner manual. If no keys are activated, the Teen Driver feature will not record any Report Card data.

A Personal Identification Number (PIN) must be created using the keypad. The PIN is required to:

- Register keys.
- Change settings.
- Access or delete Report Card data or Teen Driver settings.



### Register or Unregister a Key

Any of the vehicle keys can be registered as a Teen Driver key. Label the key to tell it apart from the other keys. A maximum of eight keys can be registered. There is one Report Card per vehicle.

After creating the PIN, to register or unregister the key(s):

1. Start the engine.
2. For automatic transmissions, the vehicle must be in P (Park). For manual transmissions, the vehicle must be stopped with the parking brake set.
3. Select Teen Driver from the Settings menu.
4. Enter the PIN.
5. Select Key Registration.

The system will display instructions for registering or unregistering a key.

### For Pushbutton start system:

Once Key Registration is selected, the system detects whether there is a transmitter key in the transmitter pocket, which is inside the center console storage area or on the side of the steering column. See “Remote Keyless Entry (RKE) System Operation” in the owner manual for transmitter pocket location.

- If no transmitter key is detected, a message displays indicating to place the transmitter key in the transmitter pocket.
- If the transmitter key is in the transmitter pocket, it will identify whether the transmitter key is registered or unregistered.
  - If the transmitter key is not registered, a message displays requesting confirmation to register. Select Register and follow the instructions. A message displays to confirm successful registration.

- If the transmitter key is already registered, the option to unregister displays. If Unregister is selected, the transmitter key is no longer registered and a confirmation displays.

In vehicles with a Pushbutton start system, if a Teen Driver transmitter key and a non-Teen Driver transmitter key are both present at start up, the vehicle will recognize the non-Teen Driver transmitter key to start the vehicle. The Teen Driver settings will not be active.

### Manage Settings

The PIN can be used to change the following settings:

**Audio Volume Limit:** Allows a maximum radio volume to be set.

**Teen Driver Speed Warning:** Allows a warning to be set when a selected speed is exceeded.

### Teen Driver Speed Limiter:

If equipped, this allows the maximum speed limit of the vehicle to be set.

The following cannot be changed:

- The radio will mute when the driver safety belt is not fastened, and in some vehicles, when the safety belt of a front outboard passenger is not fastened.
- Other vehicle features, such as Park Assist, if equipped, cannot be turned off when the Teen Driver Setting is in use.

### Delete Report Card Data

The Report Card continues to save data for all trips until the data is deleted using the PIN.

To delete Report Card data:

- Select Reset from the Report Card screen.
- Select Clear All Teen Keys/PIN from the Teen Driver menu.

See your dealer for assistance.

### Forgotten PIN

See your dealer to reset the PIN.

## Trademarks and License Agreements

### FCC Information

See "Radio Frequency Statement" in the owner manual.



"Made for iPod," and "Made for iPhone," mean that an electronic accessory has been designed to connect specifically to iPod or iPhone and has been certified by the developer to meet Apple performance standards. Apple is not responsible for the operation of this device or its compliance with safety and regulatory standards. Please note that the use of this accessory with iPod or iPhone may affect wireless performance. iPhone<sup>®</sup>, iPod<sup>®</sup>, iPod classic<sup>®</sup>, iPod nano<sup>®</sup>,

iPod shuffle<sup>®</sup>, and iPod touch<sup>®</sup> are trademarks of Apple Inc., registered in the U.S. and other countries.



Fees and Taxes: Subscription fee, taxes, one time activation fee, and other fees may apply. Subscription fee is consumer only. All fees and programming subject to change. Subscriptions subject to Customer Agreement available at [www.siriusxm.com](http://www.siriusxm.com). SiriusXM<sup>®</sup> service only available in the 48 contiguous United States and Canada.

In Canada: Some deterioration of service may occur in extreme northern latitudes. This is beyond the control of SiriusXM<sup>®</sup> Satellite Radio.

Explicit Language Notice: Channels with frequent explicit language are indicated with an "XL" preceding the channel name. Channel blocking is available for SiriusXM Satellite Radio receivers by notifying SiriusXM:

- USA Customers — See [www.siriusxm.com](http://www.siriusxm.com) or call 1-866-635-2349.
- Canadian Customers — See [www.xmradio.ca](http://www.xmradio.ca) or call 1-877-209-0079.

It is prohibited to copy, decompile, disassemble, reverse engineer, hack, manipulate, or otherwise make available any technology or software incorporated in receivers compatible with the SiriusXM<sup>®</sup> Satellite Radio System or that support the SiriusXM website, the Online Service or any of its content. Furthermore, the AMBER voice compression software included in this product is protected by intellectual property rights including

patent rights, copyrights, and trade secrets of Digital Voice Systems, Inc.

General Requirements:

1. A License Agreement from SiriusXM<sup>®</sup> is required for any product that incorporates SiriusXM Technology and/or for use of any of the SiriusXM marks to be manufactured, distributed, or marketed in the SiriusXM Service Area.
2. For products to be distributed, marketed, and/or sold in Canada, a separate agreement is required with Canadian Satellite Radio Inc. (operating as SiriusXM Canada).



immersion.

TouchSense® Technology and TouchSense® System 1000 Series Licensed from Immersion Corporation. TouchSense® System 1000 protected under one or more of the U.S. Patents at the following address [www.immersion.com/patent-marking.html](http://www.immersion.com/patent-marking.html) and other patents pending.

#### HD Radio Technology



HD Radio Technology manufactured under license from iBiquity Digital Corporation. U.S. and Foreign patents. HD Radio® and the HD, HD Radio, and “Arc” logos are proprietary trademarks of iBiquity Digital Corp.

#### DTS

Manufactured under license under U.S. Patent Nos: 5,956,674; 5,974,380; 6,487,535 & other U.S. and worldwide patents issued & pending.

DTS, the Symbol, & DTS and the Symbol together are registered trademarks & DTS 2.0 Channel is a trademark of DTS, Inc. Product includes software. ©DTS, Inc. All Rights Reserved.

#### Dolby

Manufactured under license from Dolby Laboratories. Dolby and the double-D symbol are trademarks of Dolby Laboratories.



DivX Certified® to play DivX® video, including premium content.

ABOUT DIVX VIDEO: DivX® is a digital video format created by DivX, LLC, a subsidiary of Rovi Corporation. This is an official DivX Certified® device that has passed rigorous testing to verify that it plays DivX video. Visit [divx.com](http://divx.com) for more information and software tools to convert your files into DivX videos.

ABOUT DIVX VIDEO-ON-DEMAND: This DivX Certified® device must be registered in order to play purchased DivX Video-on-Demand (VOD) movies. To obtain your registration code, locate the DivX VOD section in your device setup menu. Go to [vod.divx.com](http://vod.divx.com) for more information on how to complete your registration.

Covered by one or more of the following U.S. patents: 7,295,673; 7,460,668; 7,515,710; 7,519,274.

DivX®, DivX Certified® and associated logos are trademarks of Rovi Corporation or its subsidiaries and are used under license.

**BDA**

“Blu-ray Disc, Blu-ray, Blu-ray 3D, BD-Live, BONUSVIEW, BDXL, AVCREC, and the logos are trademarks of the Blu-ray Disc Association.”

**AVCHD**

AVCHD and the AVCHD logo are trademarks of Panasonic Corporation and Sony Corporation.

**AVCREC**

Blu-ray Disc, Blu-ray, Blu-ray 3D, BD-Live, BONUSVIEW, BDXL, AVCREC, and the logos are trademarks of the Blu-ray Disc Association.

**Java**

Java is a registered trademark of Oracle and/or its affiliates.

**Cinavia**

Cinavia Notice: This product uses Cinavia technology to limit the use of unauthorized copies of some commercially-produced film and

videos and their soundtracks. When a prohibited use of an unauthorized copy is detected, a message will be displayed or copying will be interrupted.

More information about Cinavia technology is provided at the Cinavia Online Consumer Information Center at <http://www.cinavia.com>. To request additional information about Cinavia by mail, send a postcard with your mailing address to: Cinavia Consumer Information Center, P.O. Box 86851, San Diego, CA, 92138, USA.

This product incorporates proprietary technology under license from Verance Corporation and is protected by U.S. Patent 7,369,677 and other U.S. and worldwide patents issued and pending as well as copyright and trade secret protection for certain aspects of such technology. Cinavia is a trademark of Verance Corporation. Copyright 2004-2010 Verance Corporation. All rights

reserved by Verance. Reverse engineering or disassembly is prohibited.

**RMVB**

Portions of this software are included under license from RealNetworks, Inc. Copyright 1995-2011, RealNetworks, Inc. All rights reserved.

**Bluetooth**

The Bluetooth® word mark and logos are owned by the Bluetooth® SIG, Inc. and any use of such marks by General Motors is under license. Other trademarks and trade names are those of their respective owners.

## Schedule I: Gracenote EULA



Music recognition technology and related data are provided by Gracenote®. Gracenote is the industry standard in music recognition technology and related content delivery. For more information visit [www.gracenote.com](http://www.gracenote.com).

Music-related data from Gracenote, Inc., copyright © 2000 to present Gracenote. Gracenote Software, copyright © 2000 to present Gracenote. One or more patents owned by Gracenote may apply to this product and service. See the Gracenote website for a non-exhaustive list of applicable Gracenote patents. Gracenote, CDDb, MusicID, MediaVOCS, the

Gracenote logo and logotype, and the "Powered by Gracenote" logo are either registered trademarks or trademarks of Gracenote in the United States and/or other countries.

### Gracenote Terms of Use

This application or device contains software from Gracenote, Inc. of Emeryville, California ("Gracenote"). The software from Gracenote (the "Gracenote Software") enables this application to do disc or file identification and obtain music-related information, including name, artist, track, and title information ("Gracenote Data") from online servers or embedded databases (collectively, "Gracenote Servers") and to perform other functions. You may use Gracenote Data only by means of the intended End-User functions of this application or device.

This application or device may contain content belonging to Gracenote's providers. If so, all of

the restrictions set forth herein with respect to Gracenote Data shall also apply to such content and such content providers shall be entitled to all of the benefits and protections set forth herein that are available to Gracenote.

You agree that you will use Gracenote Data, the Gracenote Software, and Gracenote Servers for your own personal non-commercial use only. You agree not to assign, copy, transfer or transmit the Gracenote Software or any Gracenote Data to any third party. **YOU AGREE NOT TO USE OR EXPLOIT GRACENOTE DATA, THE GRACENOTE SOFTWARE, OR GRACENOTE SERVERS, EXCEPT AS EXPRESSLY PERMITTED HEREIN.**

You agree that your non-exclusive license to use the Gracenote Data, the Gracenote Software, and Gracenote Servers will terminate if you violate these restrictions. If your license terminates, you agree to cease any and all use of the

Gracenote Data, the Gracenote Software, and Gracenote Servers. Gracenote reserves all rights in Gracenote Data, the Gracenote Software, and the Gracenote Servers, including all ownership rights. Under no circumstances will Gracenote become liable for any payment to you for any information that you provide. You agree that Gracenote may enforce its rights under this Agreement against you directly in its own name.

The Gracenote service uses a unique identifier to track queries for statistical purposes. The purpose of a randomly assigned numeric identifier is to allow the Gracenote service to count queries without knowing anything about who you are. For more information, see the web page for the Gracenote Privacy Policy for the Gracenote service.

The Gracenote Software and each item of Gracenote Data are licensed to you "AS IS." Gracenote makes no representations or warranties, express or implied, regarding the

accuracy of any Gracenote Data. Gracenote reserves the right to delete data from the Gracenote Servers or to change data categories for any cause that Gracenote deems sufficient. No warranty is made that the Gracenote Software or Gracenote Servers are error-free or that functioning of Gracenote Software or Gracenote Servers will be uninterrupted. Gracenote is not obligated to provide you with new enhanced or additional data types or categories that Gracenote may provide in the future and is free to discontinue its services at any time.

GRACENOTE DISCLAIMS ALL WARRANTIES EXPRESS OR IMPLIED, INCLUDING, BUT NOT LIMITED TO, IMPLIED WARRANTIES OF MERCHANTABILITY, FITNESS FOR A PARTICULAR PURPOSE, TITLE, AND NON-INFRINGEMENT. GRACENOTE DOES NOT WARRANT THE RESULTS THAT WILL BE OBTAINED BY YOUR

USE OF THE GRACENOTE SOFTWARE OR ANY GRACENOTE SERVER. IN NO CASE WILL GRACENOTE BE LIABLE FOR ANY CONSEQUENTIAL OR INCIDENTAL DAMAGES OR FOR ANY LOST PROFITS OR LOST REVENUES.

© 2014. Gracenote, Inc. All Rights Reserved.

#### **MPEG4-AVC (H.264)**

THIS PRODUCT IS LICENSED UNDER THE AVC PATENT PORTFOLIO LICENSE FOR THE PERSONAL AND NON-COMMERCIAL USE OF A CONSUMER TO (i) ENCODE VIDEO IN COMPLIANCE WITH THE AVC STANDARD ("AVC VIDEO") AND/OR (ii) DECODE AVC VIDEO THAT WAS ENCODED BY A CONSUMER ENGAGED IN A PERSONAL AND NON-COMMERCIAL ACTIVITY AND/OR WAS OBTAINED FROM A VIDEO PROVIDER LICENSED TO

PROVIDE AVC VIDEO. NO LICENSE IS GRANTED OR SHALL BE IMPLIED FOR ANY OTHER USE. ADDITIONAL INFORMATION MAY BE OBTAINED FROM MPEG LA, LLC. SEE [HTTP://WWW.MPEGLA.COM](http://www.mpegla.com).

#### **VC-1**

THIS PRODUCT IS LICENSED UNDER THE VC-1 PATENT PORTFOLIO LICENSE FOR THE PERSONAL AND NON-COMMERCIAL USE OF A CONSUMER TO (i) ENCODE VIDEO IN COMPLIANCE WITH THE VC-1 STANDARD ("VC-1 VIDEO") AND/OR (ii) DECODE VC-1 VIDEO THAT WAS ENCODED BY A CONSUMER ENGAGED IN A PERSONAL AND NON-COMMERCIAL ACTIVITY AND/OR WAS OBTAINED FROM A VIDEO PROVIDER LICENSED TO PROVIDE VC-1 VIDEO. NO LICENSE IS GRANTED OR SHALL BE IMPLIED FOR ANY OTHER USE. ADDITIONAL

INFORMATION MAY BE OBTAINED FROM MPEG LA, LLC. SEE [HTTP://WWW.MPEGLA.COM](http://www.mpegla.com).

#### **MPEG4-Visual**

USE OF THIS PRODUCT IN ANY MANNER THAT COMPLIES WITH THE MPEG-4 VISUAL STANDARD IS PROHIBITED, EXCEPT FOR USE BY A CONSUMER ENGAGING IN PERSONAL AND NON-COMMERCIAL ACTIVITIES.

#### **MP3**

MPEG Layer-3 audio coding technology licensed from Fraunhofer IIS and Thomson.

#### **WMV/WMA**

This product includes technology owned by Microsoft Corporation and under a license from Microsoft Licensing, GP. Use or distribution of such technology outside of this product is prohibited without a license from Microsoft Corporation and/or Microsoft Licensing, GP as applicable.

### **Map End User License Agreement**

#### **END USER TERMS**

The Map Data Disc ("Data") is provided for your personal, internal use only and not for resale. It is protected by copyright, and is subject to the following terms (this "End User License Agreement") and conditions which are agreed to by you, on the one hand, and HERE North America, LLC ("HERE") and its licensors (including their licensors and suppliers) on the other hand.

The Data for areas of Canada includes information taken with permission from Canadian authorities, including: © Her Majesty the Queen in Right of Canada, © Queen's Printer for Ontario, © Canada Post Corporation, GeoBase®.

HERE holds a nonexclusive license from the United States Postal Service® to publish and sell ZIP+4® information.



© United States Postal Service® 2013. Prices are not established, controlled, or approved by the United States Postal Service®. The following trademarks and registrations are owned by the USPS: United States Postal Service, USPS, and ZIP+4.

### **TERMS AND CONDITIONS**

**Personal Use Only:** You agree to use this Data for the solely personal, noncommercial purposes for which you were licensed, and not for service bureau, timesharing or other similar purposes. Except as otherwise set forth herein, you agree not to otherwise reproduce, copy, modify, decompile, disassemble or reverse engineer any portion of this Data, and may not transfer or distribute it in any form, for any purpose, except to the extent permitted by mandatory laws. You may transfer the Data and all accompanying materials on a permanent basis if you retain no copies and the recipient agrees to the terms of this End User License

Agreement. Multi-disc sets may only be transferred or sold as a complete set as provided to you and not as a subset thereof.

### **Restrictions**

Except where you have been specifically licensed to do so by HERE and without limiting the preceding paragraph, you may not (a) use this Data with any products, systems, or applications installed or otherwise connected to or in communication with vehicles capable of vehicle navigation, positioning, dispatch, real time route guidance, fleet management or similar applications; or (b) with, or in communication with, including without limitation, cellular phones, palmtop and handheld computers, pagers, and personal digital assistants or PDAs.

### **Warning**

This Data may contain inaccurate or incomplete information due to the passage of time, changing circumstances, sources used, and

the nature of collecting comprehensive geographic data, any of which may lead to incorrect results.

### **No Warranty**

This Data is provided to you “as is,” and you agree to use it at your own risk. HERE and its licensors (and their licensors and suppliers) make no guarantees, representations, or warranties of any kind, express or implied, arising by law or otherwise, including but not limited to, content, quality, accuracy, completeness, effectiveness, reliability, fitness for a particular purpose, usefulness, use or results to be obtained from this Data, or that the Data or server will be uninterrupted or error free.

### **Disclaimer of Warranty**

THE DATABASE IS PROVIDED ON AN “AS IS” AND “WITH ALL FAULTS BASIS” AND BOSCH (AND THEIR LICENSORS AND SUPPLIERS) EXPRESSLY DISCLAIM ALL OTHER WARRANTIES, EXPRESS OR

IMPLIED, INCLUDING BUT NOT LIMITED TO, THE IMPLIED WARRANTIES OF NON-INFRINGEMENT, MERCHANTABILITY, SATISFACTORY QUALITY, ACCURACY, TITLE AND FITNESS FOR A PARTICULAR PURPOSE. NO ORAL OR WRITTEN ADVICE OR INFORMATION PROVIDED BY BOSCH (OR ANY OF THEIR LICENSORS, AGENTS, EMPLOYEES, OR THIRD PARTY PROVIDERS) SHALL CREATE A WARRANTY, AND YOU ARE NOT ENTITLED TO RELY ON ANY SUCH ADVICE OR INFORMATION. THIS DISCLAIMER OF WARRANTIES IS AN ESSENTIAL CONDITION OF THIS AGREEMENT.

**Disclaimer of Liability**

HERE AND ITS LICENSORS (INCLUDING THEIR LICENSORS AND SUPPLIERS) SHALL NOT BE LIABLE TO YOU IN RESPECT OF ANY CLAIM, DEMAND OR ACTION, IRRESPECTIVE OF THE

NATURE OF THE CAUSE OF THE CLAIM, DEMAND OR ACTION ALLEGING ANY LOSS, INJURY OR DAMAGES, DIRECT OR INDIRECT, WHICH MAY RESULT FROM THE USE OR POSSESSION OF THIS DATA; OR FOR ANY LOSS OF PROFIT, REVENUE, CONTRACTS OR SAVINGS, OR ANY OTHER DIRECT, INDIRECT, INCIDENTAL, SPECIAL OR CONSEQUENTIAL DAMAGES ARISING OUT OF YOUR USE OF OR INABILITY TO USE THIS DATA, ANY DEFECT IN THIS DATA, OR THE BREACH OF THESE TERMS OR CONDITIONS, WHETHER IN AN ACTION IN CONTRACT OR TORT OR BASED ON A WARRANTY, EVEN IF HERE OR ITS LICENSORS HAVE BEEN ADVISED OF THE POSSIBILITY OF SUCH DAMAGES. Some States, Territories, and Countries do not allow certain liability exclusions or damages limitations, so to that extent the above may not apply to you.

**Export Control**

You agree not to export from anywhere any part of the Data provided to you or any direct product thereof except in compliance with, and with all licenses and approvals required under, applicable export laws, rules and regulations. Entire Agreement: These terms and conditions constitute the entire agreement between HERE (and its licensors, including their licensors and suppliers) and you pertaining to the subject matter hereof, and supersedes in their entirety any and all written or oral agreements previously existing between us with respect to such subject matter.

**Governing Law**

The above terms and conditions shall be governed by the laws of the State of Illinois, without giving effect to (i) its conflict of laws provisions, or (ii) the United Nations Convention

for Contracts for the International Sale of Goods, which is explicitly excluded. You agree to submit to the jurisdiction of the State of Illinois for any and all disputes, claims, and actions arising from or in connection with the Data provided to you hereunder.

### Government End Users

If the Data is being acquired by or on behalf of the United States government or any other entity seeking or applying rights similar to those customarily claimed by the United States government, this Data is a "commercial item" as that term is defined at 48 C.F.R. ("FAR") 2.101, is licensed in accordance with this End User License Agreement, and each copy of Data delivered or otherwise furnished shall be marked and embedded as

appropriate with the following "Notice of Use," and be treated in accordance with such Notice:

**Maps for Life**

#### NOTICE OF USE

CONTRACTOR (MANUFACTURER/  
SUPPLIER)

NAME:

**HERE North America, LLC**

CONTRACTOR (MANUFACTURER/  
SUPPLIER)

ADDRESS:

**425 West Randolph Street,  
Chicago, IL 60606.**

This Data is a commercial item as defined in FAR 2.101 and is subject to the End User License Agreement under which this Data was provided.

© 2014 HERE North America, LLC.  
All rights reserved.

If the Contracting Officer, federal government agency, or any federal official refuses to use the legend provided herein, the Contracting Officer, federal government agency, or any federal official must notify HERE prior to seeking additional or alternative rights in the Data.

#### PANDORA

PANDORA, the PANDORA logo, and the Pandora trade dress are trademarks or registered trademarks of Pandora Media, Inc. Used with permission.

#### Unicode

Copyright © 1991-2010 Unicode, Inc. All rights reserved. Distributed under the Terms of Use in <http://www.unicode.org/copyright.html>.

### Free Type Project

Portions of this software are copyright © 2010 The FreeType Project (<http://www.freetype.org>). All rights reserved.

### Open Source SW

The open source code used in this device can be downloaded at the webpage shown in the information at the center stack display. Further information concerning the OSS licenses is shown in the center stack display.

### QNX

Portions of this software are copyright © 2008-2011, QNX Software Systems. All rights reserved.

### Part C – EULA

Copyright 2011, Software Systems GmbH & Co. KG. All Rights Reserved.

The product you have purchased ("Product") contains Software (Runtime Configuration No. 505962;

"Software") which is distributed by or on behalf of the Product manufacturer "Manufacturer") under license from Software Systems Co. ("QSSC"). You may only use the Software in the Product and in compliance with the license terms below.

Subject to the terms and conditions of this License, QSSC hereby grants you a limited, non-exclusive, non-transferable license to use the Software in the Product for the purpose intended by the Manufacturer. If permitted by the Manufacturer, or by applicable law, you may make one backup copy of the Software as part of the Product software. QSSC and its licensors reserve all license+C31 rights not expressly granted herein, and retain all right, title and interest in and to all copies of the Software, including all intellectual property rights therein. Unless required by applicable law you may not reproduce, distribute or transfer, or de-compile, disassemble or

otherwise attempt to unbundle, reverse engineer, modify or create derivative works of, the Software. You agree: (1) not to remove, cover or alter any proprietary notices, labels or marks in or on the Software, and to ensure that all copies bear any notice contained on the original; and (2) not to export the Product or the Software in contravention of applicable export control laws.

EXCEPT TO THE EXTENT OTHERWISE REQUIRED BY APPLICABLE LAW, QSSC AND ITS LICENSORS PROVIDE THE SOFTWARE ON AN "AS IS" BASIS, WITHOUT WARRANTIES OR CONDITIONS OF ANY KIND, EITHER EXPRESS OR IMPLIED INCLUDING, WITHOUT LIMITATION, ANY WARRANTIES OR CONDITIONS OF TITLE, NON-INFRINGEMENT, MERCHANTABILITY OR FITNESS FOR A PARTICULAR PURPOSE. ANY WARRANTIES OR OTHER PROVISIONS OFFERED BY THE

MANUFACTURER OR ITS DISTRIBUTOR(S) THAT DIFFER FROM THIS LICENSE ARE OFFERED BY THE MANUFACTURER OR ITS DISTRIBUTOR(S) ALONE AND NOT BY QSSC, ITS AFFILIATES OR THEIR LICENSORS. YOU ASSUME ANY RISKS ASSOCIATED WITH YOUR USE OF THE SOFTWARE UNDER THIS LICENSE.

EXCEPT TO THE EXTENT OTHERWISE REQUIRED BY APPLICABLE LAW (SUCH AS IN THE CASE OF DELIBERATE OR GROSSLY NEGLIGENT ACTS), IN NO EVENT SHALL QSSC, ITS AFFILIATES OR THEIR LICENSORS BE LIABLE TO YOU UNDER ANY LEGAL THEORY, WHETHER IN TORT (INCLUDING NEGLIGENCE), CONTRACT OR OTHERWISE, FOR DAMAGES, INCLUDING ANY DIRECT, INDIRECT, SPECIAL, INCIDENTAL, OR CONSEQUENTIAL DAMAGES

OF ANY CHARACTER ARISING AS A RESULT OF THIS LICENSE OR OUT OF THE USE OR INABILITY TO USE THE PRODUCT (INCLUDING BUT NOT LIMITED TO DAMAGES FOR LOSS OF GOODWILL, WORK STOPPAGE, PRODUCT FAILURE OR MALFUNCTION, OR ANY AND ALL OTHER COMMERCIAL DAMAGES OR LOSSES), EVEN IF QSSC, ITS AFFILIATES OR THEIR LICENSORS HAVE BEEN ADVISED OF THE POSSIBILITY OF SUCH DAMAGES.

#### **WMA**

This product is protected by certain intellectual property rights of Microsoft. Use or distribution of such technology outside of this product is prohibited without a license from Microsoft.

For more information on the Software, including any open source software license terms (and available source code) as well as

copyright attributions applicable to the Runtime Configuration indicated above, please contact the Manufacturer or contact QSSC at 175 Terence Matthews Crescent, Kanata, Ontario, Canada K2M 1W8 (licensing@qnx.com).

#### **Linotype**

Helvetica is a trademark of Linotype Corp. registered in the U.S. Patent and Trademark Office and may be registered in certain other jurisdictions in the name of Linotype Corp. or its licensee Linotype GmbH.

Usage in text form of each of the Licensed Trademarks is:

The trademark attribution requirements for the Licensed Trademarks may be viewed at <http://www.linotype.com/2061-19414/trademarks.html>.

### END USER NOTICE

The marks of companies displayed by this product to indicate business locations are the marks of their respective owners. The use of such marks in this product does not imply any sponsorship, approval, or endorsement by such companies of this product.

**A**

Accepting or Declining a Call ... 111  
 AM ..... 22  
 AM-FM Radio ..... 11  
 Antenna  
     Multi-band ..... 23  
 Applications Tray ..... 8  
 Apps ..... 7  
 Audio ..... 7  
     Bluetooth ..... 34  
 Audio Output ..... 51  
 Audio Players ..... 27  
     CD ..... 27  
 Audio System ..... 109  
     Backglass Antenna ..... 22  
     Radio Reception ..... 22  
 Auxiliary Inputs ..... 50  
 Auxiliary Jack ..... 34  
 AVCHD ..... 125  
 AVCREC ..... 125

**B**

BDA ..... 125  
 Before Driving ..... 36  
 Bluetooth ..... 119, 125  
     Overview ..... 108, 109, 113  
 Bluetooth Audio ..... 34

**C**

Call Waiting ..... 112  
 Canceling Voice Recognition ... 102  
 Card Reader  
     SD ..... 33  
 CD Player ..... 27  
 Cell Phone Usage ..... 22  
 Character Handwriting  
     Recognition ..... 81  
 Charging  
     Wireless ..... 115, 116  
 Cinavia ..... 125  
 Cleaning High Gloss Surfaces  
     and Vehicle Information and  
     Radio Displays ..... 11  
 Cleaning the Components ..... 67

Cleaning the Video Screens ..... 67  
 Clearing the System ..... 114  
 Climate ..... 8  
 Controls ..... 108  
     Steering Wheel ..... 6  
 Customer Assistance ..... 4

**D**

Database Coverage  
     Explanations ..... 100  
 Destination, Navigation ..... 79  
 Detailed Areas ..... 76  
 Display ..... 97, 119  
 Dolby ..... 124  
 Driver  
     Teen ..... 120  
 Driving on a Route ..... 78  
 DTS ..... 124  
 Dual Tone Multi-Frequency  
     (DTMF) Tones ..... 113  
 DVD  
     Rear Seat Entertainment  
     System ..... 36, 55

**E**

Ending a Call .....	112
Energy (If Equipped) .....	7
English and Metric Unit Conversion .....	120
Error Messages .....	28

**F**

Finding a Station .....	13
FM .....	22

**G**

Global Positioning System (GPS) .....	98
--	----

**H**

Haptic Feedback .....	9
HD Radio Technology .....	15
Headphones .....	49
Helpful Hints for Speaking Commands .....	102
Home Page .....	5

**I**

Infotainment .....	3
Infotainment Gestures .....	9
Infotainment System .....	4
Infotainment System Settings ....	11
Internet Radio Pandora .....	23

**J**

Jack Auxiliary .....	34
Java .....	125

**L**

Language .....	118
Launching Pandora .....	24
Loading and Ejecting Discs .....	27
Low Fuel Alert .....	97

**M**

Making a Call .....	113
Making a Call Using Contacts and Recent Calls ....	111
Making a Call Using the Keypad .....	111
Map Adjustments .....	75
Map Data Updates .....	100
Map End User License Agreement .....	128
Maps .....	76
Menus and Features .....	37
Messaging Text .....	114
Mixed-Audio Favorites .....	13
MP3 Guidelines .....	29
Multi-band Antenna .....	23

**N**

NAV/ OnStar NAV .....	7
Navigation Destination .....	79
Symbols .....	77
Using the System .....	68



**O**

OnStar (If Equipped) ..... 8  
 OnStar System ..... 35  
 OnStar® System ..... 95  
 OnStar® with 4G LTE ..... 35  
 Overview, Infotainment System ... 3

**P**

Pairing ..... 109  
 Pandora (If Equipped) ..... 7  
 Pandora Internet Radio ..... 23  
 Pandora Troubleshooting ..... 25  
 Phone ..... 7  
     Bluetooth ..... 108, 109, 113  
 Playing an Audio MP3 or CD ... 27  
 Playing Audio CD ..... 65  
 Playing from a USB ..... 29  
 Playing MP3 CD ..... 66  
 Playing the Radio ..... 11  
 Port  
     USB/SD ..... 29  
 Power (On/Off/Mute) ..... 4  
 Problems with Route  
     Guidance ..... 99  
 Proximity Sensing ..... 8

**R**

Radio ..... 118  
     HD Radio Technology ..... 15  
 Radios  
     AM-FM Radio ..... 11  
     Reception ..... 22  
     Satellite ..... 16  
 Rear Camera ..... 120  
 Rear Climate (If Equipped) ..... 8  
 Rear Seat Armrest Control  
     Panel ..... 5  
 Rear Seat Entertainment  
     System ..... 36, 55  
 Remote Control ..... 51, 62  
 Return to Factory Settings ..... 120  
 RMVB ..... 125  
 RSE Controls Available from  
     the Front Screen ..... 46  
 RSE Overview System ..... 56

**S**

Satellite Radio ..... 16  
 Schedule I: Gracenote EULA ... 126  
 Scroll Features ..... 75  
 SD Card Reader ..... 33  
 Settings ..... 96, 118, 7

SiriusXM Menu ..... 16  
 SiriusXM NavTraffic (If  
     Equipped) ..... 20  
 SiriusXM Satellite Radio  
     Service ..... 22  
 SiriusXM Satellite Radio  
     Service (If Equipped) ..... 16  
 SiriusXM Travel Link (If  
     Equipped) ..... 17  
 SiriusXM Travel Link Fuel  
     Pricing (If Equipped) ..... 21  
 SiriusXM Travel Link Movie  
     Listings ..... 21  
 Software Updates ..... 11  
 Sources ..... 37  
 Steering Wheel Controls ..... 6  
 Storing and Recalling Media  
     Favorites ..... 33  
 Storing Radio Station Presets ... 13  
 Switching to Handset or  
     Handsfree Mode ..... 110  
 Symbols, Navigation ..... 77  
 System  
     Infotainment ..... 3  
     System Needs Service, If ..... 99  
     System Operation ..... 36

**T**

Teen Driver .....	120
Text Menu .....	114
Text Messaging .....	114
Text Settings .....	115
Three-Way Calling .....	112
Time and Date .....	118
Timeshifting .....	14
Tips and Troubleshooting .....	67
Touchscreen Buttons .....	8
Trademarks and License Agreements .....	122
Turn List .....	93

**U**

Updates	
Map Data .....	100
Software .....	11
USB/SD Port .....	29
Using Bluetooth Voice Recognition .....	113
Using the RSE On-Screen Display (OSD) Menus .....	58

Using the System .....	7
Using Voice Recognition .....	101
Using Voice Recognition for List Options .....	103

**V**

Valet Mode (If Equipped) .....	118
Vehicle	
Positioning .....	98
Vehicle Settings .....	119
Vehicle Speakers .....	61
Video (If Equipped) .....	8
Video Display Error Messages ...	55
Video Display Screens .....	55
Video Distortion .....	55
Viewing a Text Message .....	115
Viewing Sender Information ...	115
Voice .....	97, 119
Voice Mail .....	113
Voice Pass-Thru .....	107
Voice Recognition .....	100
Voice Recognition for Audio My Media .....	105

Voice Recognition for Navigation .....	106
Voice Recognition for OnStar (If Equipped) .....	108
Voice Recognition for the Phone .....	107
Voice Recognition for the Radio .....	104
Voice Recognition for Weather (If Equipped) .....	108
Volume .....	5

**W**

Weather (If Equipped) .....	8
Wired Headphones .....	62
Wireless Charging .....	115, 116