

# SEIKO

---

---

## **KT-601 *Sports Counter***

---

---

# OPERATING MANUAL

Thank you for purchasing SEIKO SPORTS COUNTER KT-601.  
Before using your SEIKO SPORTS COUNTER, please read this  
manual carefully for its proper use and care.  
Keep this manual handy for ready reference.

## CAUTION

- (1) This manual may not be copied or reproduced in any form, in whole or in part, without the express written consent of SEIKO.
- (2) This manual may be subject to change without notice.
- (3) This manual has been prepared carefully to provide you with complete information for the operation of this product. For the purpose of constant improvement in this manual, your suggestions and comments on the descriptions included in it are highly appreciated.
- (4) SEIKO shall not be liable for any failure of this product or direct or indirect damages resulting from such failure if such failure is caused due to abuse, misuse, failure to observe instructions in this manual and neglect of other reasonable care, and servicing, changes, modifications or alterations performed by other than SEIKO or a servicing contractor authorized by SEIKO.

## SAFETY ALERT SYMBOLS

The symbols and terms used in this manual have the meaning as explained below:



**WARNING**

WARNING is used to indicate a potentially hazardous situation which is likely to cause death or severe personal injury if the instructions under this heading are not followed correctly.



**CAUTION**

CAUTION is used to indicate a potentially hazardous situation which is likely to cause personal injury or property loss if the instructions under this heading are not followed correctly.

The following pictorial symbols indicate what must NOT be done.



General prohibition



Prohibition against disassembly/tampering



Prohibition against use near water



Prohibition against handling with wet hands



Prohibition against exposure to water

The following pictorial symbols indicate what must be done.



General instructions













Extraction of power plug

## Table of Contents









1. SAFETY PRECAUTIONS.....	1
2. NAMES AND FUNCTIONS OF PARTS.....	3
3. BEFORE USING YOUR SPORTS COUNTER.....	4
4. METHOD OF OPERATION.....	5
4-1 Basketball (24 Sec. Timer).....	5
4-2 Basketball (Timeout Timer).....	8
4-3 Basketball (Team Fouls).....	9
4-4 Volleyball.....	10
4-5 Judo: Contest Timer/ Osaekomi Timer.....	12
4-6 TENNIS.....	14
4-7 Soft Tennis.....	16
4-8 Boxing.....	17
4-9 Programmable Timer.....	19
4-10 Pace Setter.....	21
4-11 Stopwatch.....	22
4-12 Timer (with Warning Buzzer).....	25
4-13 Clock & Alarm.....	26
4-14 Factory Default Settings (Initial Setting) of Each Event/Function.....	27
5. HOW TO USE INFRARED WIRELESS REMOTE CONTROLLER.....	28
6. CONNECTION WITH OTHER DEVICES INCLUDING ANOTHER KT-601.....	30
6-1 Use of Sports Counter KT-601 as Master Device.....	30
6-2 Receiver/ Sports Counter.....	31
6-3 Receiver/ Sports Printer.....	31
6-4 Receiver/ Game Operation Board.....	31
7. PRODUCT COMPOSITION AND SPECIFICATIONS.....	32

## 1. SAFETY PRECAUTIONS

The following precautions must be strictly observed for the safety of yourself and your fellow workers and for the protection of property from loss and damages.

 <b>WARNING</b>		
Actions to be taken in case of troubles	If the Product is giving out smoke or burnt smell, or showing other abnormal symptoms, turn off the power switch and cut the power supply immediately. Then, call your nearby SEIKO dealer or agent for repair serve. If the Product is used again without being reconditioned, an electric shock or fire may be caused.	
Caution on cable connection	When unplugging the power cord from the outlet, do not pull the cord, but hold the plug. An electric shock, a malfunction or fire may be caused.	
	Never use any damaged power cord or plug, or loose socket. An electric shock, short circuit or fire may result.	
	Do not use the Product at humid or dusty places, or places where the temperature changes abruptly. A short circuit or electric shock may result.	
Prohibition against unauthorized disassembly, repair or modification	Unless you are a qualified electrician, never try to disassemble, repair or modify the Product. For repair serve, contact your nearby SEIKO dealer or agent. Unauthorized disassembly, repair or modification may cause an electric shock or fire.	
No foreign matter	Do not let any foreign matter such as pin and a piece of metal enter into the inside of the Product. In case this has occurred, turn off the power switch immediately, and call your nearby SEIKO dealer or agent for inspection. If the Product is used again without being reconditioned, an electric shock or fire may result.	
Prohibition against use near water	The Product is designed for indoor use only, and its case is not water resistant. Never expose the Product to water. Do not use it outdoors or near a swimming pool, where it may be exposed to rain or splashes of water. A short circuit or electric shock may result.	
Prohibition against handling with wet hands	Never operate the Product with wet hands. An electric shock or malfunction may result.	
Prohibition against exposure to water	Do not get the power and other connectors wet. A burn or a malfunction may be caused.	

## CAUTION

<p>Do not leave the Product under direct sunlight for a long time. The temperature inside it may rise excessively to damage the circuit and other parts.</p>	
<p>Before connecting the power cord and other cables to the Product, be sure to check that the power switch is turned off. Do not use any power cord or cable other than specified. Otherwise, an electric shock or malfunction may be caused.</p>	
<p>This Product is equipped with precision electronic circuits. Misuse or abuse, or rough handling of the Product may adversely affect the performance of such electronic circuits, causing a malfunction and reducing the serviceable life of the Product.</p>	
<p>When the power switch is turned on and off or vice versa in succession, an interval of at least 5 seconds should be provided between the switch operations.</p>	
<p>Before moving the Product, be sure to turn off the power switch. An electric shock or malfunction may result.</p>	
<p>While the Product is not in use, be sure to keep the power plug disconnected from the outlet. Otherwise, the insulation will be deteriorated to cause an electric shock, leakage of electricity, or fire.</p>	
<p>If any abnormal operation occurs due to an abnormal signal transmitted from outside or other causes, turn off the power switch, and then turn it on again after at least 5 seconds.</p>	
<p>When connecting the cables, insert the plugs properly. Otherwise, a malfunction or abnormal operation may be caused.</p>	
<p>Do not expose the case of the Product to solvents such as alcohol and gasoline, spray of cosmetics or the like, cleaners, adhesives, or paints. They may discolor, deteriorate or damage the case due to chemical change.</p>	

## 2. NAMES AND FUNCTIONS OF PARTS

### <Front Side>

Serve/ Possession/  
Tempo display

<Timer section>  
Time/ Points won/ No. of times  
repeated

Period

Guest/  
Home

Points won/ Set count/  
Sets won/ Hour digits of  
time/ Others

Points/ Set count/ Games won/  
Program No./ 1/10 second digits  
of time/ Others



Buzzer

<Second timer section>  
24 seconds/ Time-out/ Sets won/ Split time/  
Lap time/ Others

### <Rear Side>

<Operation Panel>

Power switch  
<POWER>

Connectors for  
data signal  
<SIGNAL>

Connector for  
external buzzer  
<EXT.BUZZER>



Connector for adaptor with  
power cable  
<DC IN>

Stopper to prevent adaptor  
with power cable from  
dropping

Connector for grip  
switch  
<GRIP SWITCH>

### <Operation Panel>

Setting button

Game reset button

<Display monitor>

Equipment  
connection  
button

Buzzer button

Buzzer selector

Remote control  
setting button

Events/  
Functions

24-/30-sec. timer  
selector button

Selector button

<Timer Section>

Section for buttons for set count, court change,  
points, etc.



<Second timer  
section>



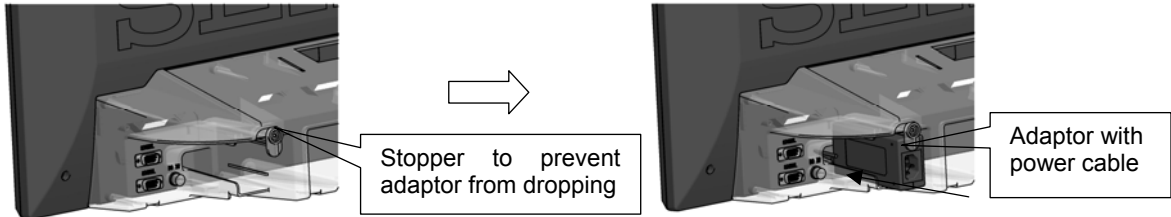

### 3. BEFORE USING YOUR SPORTS COUNTER

1. Insert the plug of the adaptor with power cable securely into the power connector of the main unit. Fix the adaptor with the stopper to prevent it from dropping, and insert the power plug of the adaptor into the outlet properly.



2. Turn on the power switch (POWER).
3. Press  button to select the desired event or function. The button is disabled while the setting procedure is performed or the timer is counting.
4. To enable  button, press  button to reset the Sports Counter.

### 5. FACTORY DEFAULT SETTINGS

- a. To reset the current event/function settings to the default settings:  
By keeping  button pressed for 2 seconds while the setting procedure is not performed, the current event/function settings are cleared, and the factory default settings will be restored.
  - b. By turning on the power while keeping  button pressed, all the current settings will be reset to the factory default settings. (The LED on the front side and the display monitor flash for 3 seconds to indicate that all the current settings have been reset.)
  - c. For the factory default settings, refer to “4-14 Factory Default Settings (Initial Settings) of Each Event/Function”.
6. By pressing  button, the volume and the manner of ringing of the buzzer can be selected from 5 patterns, namely, “high and continuous”, “high and intermittent”, “silent”, “low and continuous”, and “low and intermittent” as shown below.



\* While in the Pace Setter function (4-10), the buzzer rings in a fixed manner irrespective of the above setting.

The buzzer keeps ringing while the buzzer button  is kept pressed.

7. A power failure backup function is provided. If the power plug is disconnected from the outlet by accident or a power failure occurs, the display becomes blank, but the condition immediately before the power failure returns when the power is restored, provided that the Clock (4-13) should be re-adjusted.
8. To use the wireless remote controller, press  button to select from the following.

Indications shown on the display monitor:

- “ F ” ... When operating Sports Counter from its front
- “ b ” ... When operating Sports Counter from its back
- “ — ” ... When remote controller is not used

For the details of button operation of the remote controller, refer to “5. BUTTON OPERATION OF WIRELESS REMOTE CONTROLLER”.

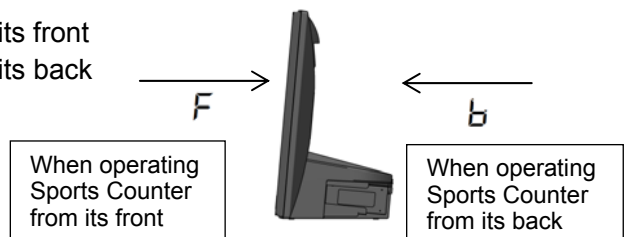

9. When using Sports Counter KT-601 as a master device, press  button to select “1. Master”.  
For the details of connection with other devices, refer to “6. CONNECTION WITH OTHER DEVICES INCLUDING ANOTHER KT-601”.

## 4. METHOD OF OPERATION

### 4-1 Basketball (24 Sec. Timer)

(1) Items shown on the display panel:

- ① Counting of time of period, interval, half time, etc. is displayed on the Timer Section (up to 99 minutes and 59 seconds can be set).
- ② Points of the team on each side are displayed (up to 199 vs. 199).
- ③ Counting of 24 or 30 seconds is displayed.
- ④ A mark is lighted to indicate the team possessing the ball.
- ⑤ "H" (HOME), "G" (GUEST), and the number of periods (up to 5 periods) are shown by respective lighted marks.

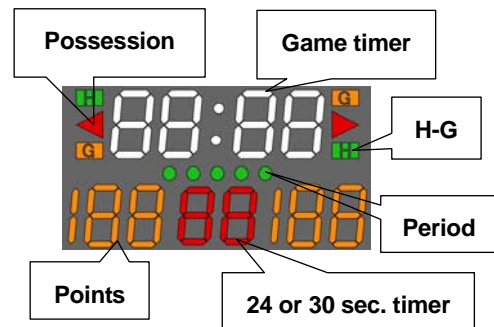

(2) Items that can be adjusted:

- ① Up to 9 programs can be set.
- ② 24 and 14 seconds can be adjusted to a desired time.
- ③ The color of the LED indicating 24 seconds can be selected from red and green.
- ④ When the time set for the timer is less than 1 minute, the timer can be set to count in 1/10 second increments (default setting) of 1 second increments as necessary.
- ⑤ The timer can be set to count down or up the set time.



\* For the default settings, refer to 4-14 of this manual.

\* If Sports Counter is used with the default settings, the following procedure of confirmation of settings and adjustment need not be performed.











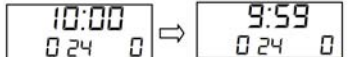

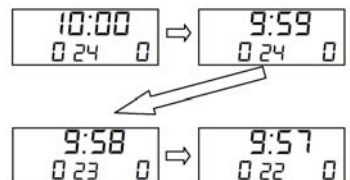





#### ■ Method of Confirmation/Adjustment of Settings

	Operation	Timer section	2nd timer section	Section for points, etc.	Action/Remarks	Display monitor
1	To activate setting mode					
2	To confirm/adjust Program 1					
3	To register Program 1, and move to Program 2 setting.					
4	<p>*1. To adjust the settings for Program 3 and more Programs, follow the above steps.                      *2. Once "0:00" is set for the time of a Program during the setting mode, the setting procedure of the rest of the Programs will be cancelled.                      *3. Programs 8 and 9 have no default setting.</p>					
5	24 seconds can be adjusted as desired.				Adjustment can be made at any time during setting mode (not in the case of 30 seconds).	
6	14 seconds can be adjusted as desired.				Adjustment can be made at any time during setting mode.	
7	Color of 24-sec. timer can be selected.				Color of 24-sec. timer changes alternately between red and green.	Color of 24 seconds on display monitor remains the same. Color of LED on display panel will change.
8	After all settings are completed, change over to game mode.					

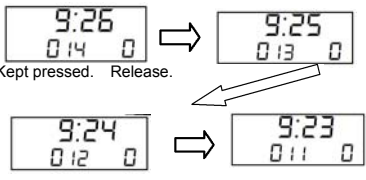

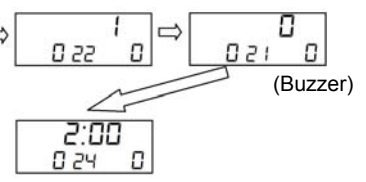







- \*1. With each press of  button while in the setting mode, the timer can be set to count upward (UP) and downward (DOWN) alternately.
- \*2. When the time set for the timer is less than 1 minute, pressing  button will set the timer to count in 1/10 second increments instead of 1 second increments. The button operation can be made at any time, as long as the timer is set to count downward (DOWN). 1/10-second-interval counting is not available when the timer is set to count upward (UP).



● Operation Procedure: Start of Game

	Operation	Timer section	2nd timer section	Section for points, etc.	Action/Remarks	Display monitor
1	To start the game				Counting is started.	
2	To start 24-sec. timer				Start 24-sec. timer when a player possesses the ball.  While the button is kept pressed, timer is stopped, indicating "24".	
3	To start and stop 24-sec. timer during game					
4	To adjust 24 seconds		  		Operation can be made only while timer is stopped.  Counting restarts.  Pressing "Clear" button resets time to "24", and stops timer.	
5	To adjust game time	  			Operation can be made only while game timer is stopped.	
6	To restart game To start 14-sec. timer				Game timer is restarted.  While 14-sec. timer start button is kept pressed, timer is stopped, indicating "14".	
7	End of 1st period: Interval display is shown.		 		Game timer is stopped automatically (buzzer rings).  Interval display appears automatically.  24-sec. timer continues counting. Press "Clear" button to stop and reset timer.	
8	To skip period/interval time				Pressing "Reset" button while timer is stopped will ring buzzer and advance timer to the next period/interval time.	(Buzzer rings.)
9	To change 24 to 30 seconds or vice versa				Operation can be made only while 24-sec. timer is stopped.	
10	End of game: To reset game time				Display returns to the settings made before the game.	

● Operation Procedure: Display of Points, Possession, and Court Change

	Operation	Timer section	2nd timer section	Section for points, etc.	Action/Remarks	Display monitor
1	To increase points of right-side team					
2	To show possession display of team on left side				Pressing the button again while possession display is shown will clear the display.	 → 
3	To change court				If possession or “H-G” display is shown, court change is made automatically.	
4	To clear points				Only points are cleared. Time, possession and 24-sec. timer remain unchanged.	

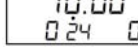
● Operation Procedure: Period and “H” (Home) – “G” (Guest) Indication

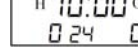
	Operation	Timer section	2nd timer section	Section for points, etc.	Action/Remarks	Display monitor
1	To change number of periods				Period marks are lighted from left to indicate number of periods (up to 5 periods).	
2	To change over between “H” and “G”				Operation can be made while the game is in progress.	

## 4-2 Basketball (Timeout Timer)

(1) Items shown on the display panel:

- ① Timeout time is displayed (up to 99 seconds).
- \* The items displayed and the settings other than the timeout time are the same as in the case of "4-1 Basketball (24 Sec. Timer)".

(2) Items that can be adjusted:

- ① Any desired amount of time can be set for the timeout timer in 1 second increments.
- ② The color of the LED for the time-out display can be selected from red and green.
- \* For the default settings, refer to 4-14 of this manual.
- \* If Sports Counter is used with the default settings, the following procedure of confirmation of settings and adjustment need not be performed.

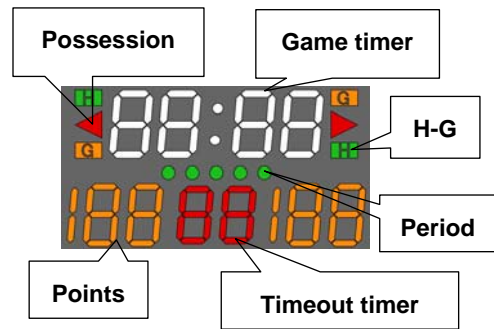

### ■ Method of Confirmation/Adjustment of Timeout Time Settings

	Operation	Timer section	2nd timer section	Section for points, etc.	Action/Remarks	Display monitor
1	To activate timeout timer setting mode					
2	To adjust timeout time from 60 seconds to any desired amount of time				Operation can be made at any time while setting mode is activated.	
3	To change color of timeout time display				Color of timeout time display changes alternately between red and green.	Color of timeout time on display monitor remains the same. Color of LED on display panel will change.
4	After all settings are completed, change over to game mode.					

### ● Operation procedure: Start of Game and Timeout Time

	Operation	Timer section	2nd timer section	Section for points, etc.	Action/Remarks	Display monitor
1	To start the game				Counting is started.	
2	To stop game time To start timeout timer					
3	To stop timeout timer To change timeout time					
4	To stop timeout timer before set time is up				Timeout timer is stopped. Timeout time display disappears.	
5	When timeout time is up				Timeout timer is stopped automatically with a buzzer sound. Timeout time display disappears automatically.	

### 4-3 Basketball (Team Fouls)

(1) Items shown on the display panel:

- ① The number of team fouls is displayed.
  - 0~4 fouls are indicated in green (default setting).
  - 5 or more fouls are indicated in red (default setting).
- \* The items displayed and the settings other than the timeout time are the same as in the case of "4-1 Basketball (24 Sec. Timer)".

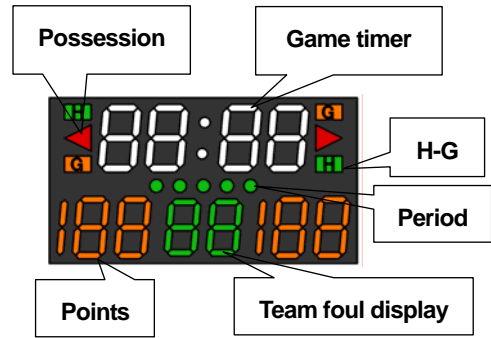

(2) Items that can be adjusted:

- ① The number of fouls to be indicated in red can be changed as desired.
  - \* For the default settings, refer to 4-14 of this manual.
  - \* If Sports Counter is used with the default settings, the following procedure of confirmation of settings and adjustment need not be performed.

#### ■ Method of Confirmation/Adjustment of Team Foul Settings

	Operation	Timer section	2nd timer section	Section for points, etc.	Action/Remarks	Display monitor
1	To activate team foul setting mode					 LED on front side is green.
2	To change number of fouls to be indicated in red				When number of team fouls reaches the set number, color of team foul display changes from green to red.	 LED on front side is red.
3	After all settings are completed, change over to game mode.					

#### ● Operation Procedure: Team Fouls Display

	Operation	Timer section	2nd timer section	Section for points, etc.	Action/Remarks	Display monitor
1	To increase team fouls committed by right-side team					
2	When fouls of teams on left and right sides are "2" and "5", respectively:				Fouls of left-side team: 2 Fouls of right-side team: 5	 LED on front side (2: green, 5: red)
3	To clear team fouls					

## 4-4 Volleyball

(1) Items shown on the display panel:

- ① Interval time is displayed.
- ② Points of the team on each side are displayed.
- ③ Team to serve and team calling timeout is indicated by lighting of a mark.
- ④ The time to sound end-of-interval warning buzzer can be programmed, and the program number is displayed while the program is engaged.
- ⑤ Sets won by the team on each side are displayed.
- ⑥ Timeout time, and 1st/2nd serve indication are displayed.
- ⑦ "H" (HOME), "G" (GUEST), and the number of periods (up to 5 periods) are shown by respective lighted marks.

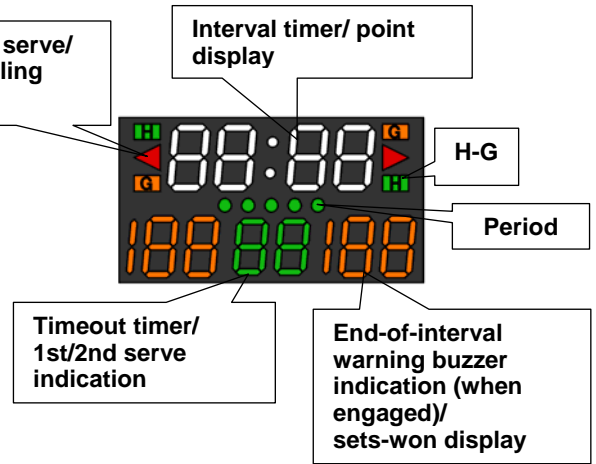

(2) Items that can be adjusted:

- ① Interval time can be adjusted.
  - ② The time to sound end-of-interval warning buzzer can be programmed (up to 9 programs).
  - ③ Timeout time can be adjusted as desired (from 0 to 99 seconds).
  - ④ The color of the LED indicating timeout time can be selected from red and green.
- 1st/2nd serve indication is indicated by the same selected color.

\* For the default settings, refer to 4-14 of this manual.

### ■ Method of Confirmation/Adjustment of Interval Time, Time to Sound End-of-Interval Warning Buzzer and Timeout Time Settings

	Operation	Timer section	2nd timer section	Section for points, etc.	Action/Remarks	Display monitor
1	To activate timeout/interval time setting mode					
2	To register interval time, and move to mode to set time to sound end-of-interval buzzer 1					
3	To register time to sound end-of-interval buzzer 1, and move mode to set time to sound end-of-interval buzzer 2					
4	*1. To set the time to sound end-of-interval buzzer 2 and more buzzers, follow the above steps. *2. No default setting has been programmed for the time to sound end-of-interval buzzer.					
5	To change timeout time from 30 to 25 seconds				Operation can be made at any time while setting mode is activated.	
6	Color of timeout time display can be selected.				Color of timeout time display changes alternately between red and green.	Color of timeout time on display monitor remains the same. Color of LED on display panel will change. (1st/2nd serve indication is indicated by the same color.)
7	To register time to sound end-of-interval buzzer 2, and change over to game mode					

\*1. With each press of button while in the setting mode, the interval timer can be set to count upward (UP) and downward (DOWN) alternately.

● Operation Procedure: Serve/ Points/ Sets Won/ Court Change Display

	Operation	Timer section	2nd timer section	Section for points, etc.	Action/Remarks	Display monitor
1	To indicate right-side team is to serve/ to increase points of right-side team				Mark to indicate right-side team is to serve lights up. Another press clears the mark.	
2	To increase sets won by right-side team To clear points				Right-side team won a point, and sets won are increased by one.	
3	To change court				Points, sets won, and team-to-serve marks of both teams change places.	
4	To clear sets won				Sets won of both teams are reset to "0".	

● Operation Procedure: 1st/2nd Serve Display, Set Count, and "H" (Home) – "G" (Guest) Indication

	Operation	Timer section	2nd timer section	Section for points, etc.	Action/Remarks	Display monitor
1	To indicate 1st/2nd serve and turn off the indication				With each press of "+" or "-", indication changes in the order of 1→2→blank, or 2→1→blank, respectively.	
2	To display set count (period)				Set count (period) marks light up one by one from left to right (up to 5 sets)	
3	To change over "H" and "G"				Operation can be made during game.	

● Operation Procedure: Start of Interval Time

	Operation	Timer section	2nd timer section	Section for points, etc.	Action/Remarks	Display monitor
1	To start interval timer					
2	Interval time can be stopped and adjusted					
3	Programmed end-of-interval warning buzzer				End-of-interval warning buzzer sounds at the programmed time.	
4	End of interval				Interval timer stops and disappears automatically with a buzzer sound. Mode returns to game.	

● Operation Procedure: Start of Timeout Time

	Operation	Timer section	2nd timer section	Section for points, etc.	Action/Remarks	Display monitor
1	To start timeout timer					
2	To stop timeout time before it is up				Timeout timer stops. Timeout timer disappears.	
3	End of timeout				Timeout timer stops and disappears automatically with a buzzer sound.	

## 4-5 Judo: Contest Timer/ Osaekomi Timer

(1) Items shown on the display panel:

- ① Contest time is displayed (up to 99 hours and 59 minutes can be set for the timer).
- ② Osaekomi time is displayed (indication for the contestant entering osaekomi can be displayed).

(2) Items that can be adjusted:

- ① Contest time can be adjusted as desired.
- ② Osaekomi time can be adjusted as desired.

\* For the default settings, refer to 4-14 of this manual.



### ■ Method of Confirmation/Adjustment of Settings

	Operation	Timer section	2nd timer section	Section for points, etc.	Action/Remarks	Display monitor
1	To activate contest/osaekomi time setting mode					
2	Contest time can be adjusted. Osaekomi time can be adjusted.					
3	If the contestant has already been awarded waza-ari, osaekomi time can also be adjusted.				Ex.) 20 sec. → 19sec.. To change over between osaekomi times with and without waza-ari, press	
4	To register setting, and change over to contest mode					

\*1. With each press of button while in the setting mode, the contest timer can be set to count upward (UP) and downward (DOWN) alternately.



### ● Operation Procedure: Start of Contest (Ex.: Contest Time - 5 minutes, Osaekomi Time - 25 seconds)

	Operation	Timer section	2nd timer section	Section for points, etc.	Action/Remarks	Display monitor
1	To start contest timer				Contest timer starts counting.	
2	To start osaekomi timer immediately after osaekomi was escaped		 		Osaekomi timer starts counting.  To start osaekomi timer immediately after osaekomi was escaped, press	
3	When osaekomi has been escaped but contest is in progress		 		Osaekomi timer is stopped.  Osaekomi time is reset to original time.	
4	When 25 seconds of osaekomi time has elapsed (ippon), or contest is ended				Contest and osaekomi timers stop automatically with a buzzer sound.	
5	To show display for a new contest				Display is reset to the settings you made initially.	



\*1. Pressing button (possession/serve button) will light up the LED indicating the contestant applying osaekomi. Another press of the button will turn off the LED.

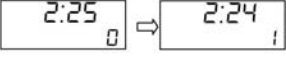

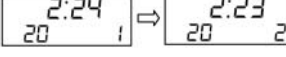
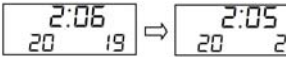
● Operation Procedure: Start of Contest (When Contestant Awarded Waza-Ari Applies Osaekomi)

	Operation	Timer section	2nd timer section	Section for points, etc.	Action/Remarks	Display monitor
1	To start osaekomi timer				Osaekomi timer starts counting.	
2	When contestant awarded waza-ari applies osaekomi				Osaekomi time is changed to 20 seconds.	 Full osaekomi time is indicated at lower left corner.
3	When 20 seconds of osaekomi time has elapsed (ippon), and contest is ended.				Contest and osaekomi timers stop automatically with a buzzer sound.	 (Buzzer)

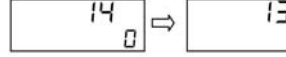
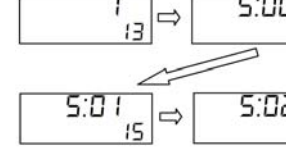
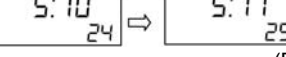
● Operation Procedure: Start of Contest (When Osaekomi Continues after Contest Time is Up)

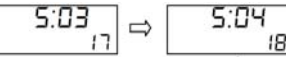
	Operation	Timer section	2nd timer section	Section for points, etc.	Action/Remarks	Display monitor
1	To start osaekomi timer				Osaekomi timer starts counting.	
2	Contest time is over.				Display shows the set contest time, and timer starts counting from that time (indicating total contest time).  Buzzer does not ring, and osaekomi timer continues counting.	
3-1	When 25 seconds of osaekomi time has elapsed (ippon), and contest is ended				Contest and osaekomi timers stop automatically with a buzzer sound.	 (Buzzer)
3-2	When osaekomi is escaped before osaekomi time has elapsed, and contest is ended				Osaekomi timer stops counting, and contest timer is stopped with a buzzer sound.	 (Buzzer)

● Operation Procedure: Start of Contest

(Ex.: If “osaekomi” button is pressed 2 seconds after the contest time is over, osaekomi is considered to have started at the same time as the contest was ended, and the osaekomi timer starts counting.)

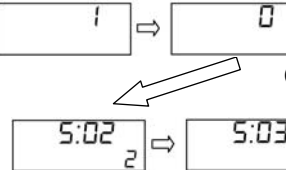
	Operation	Timer section	2nd timer section	Section for points, etc.	Action/Remarks	Display monitor
1	Contest time is over.  Osaekomi started at the same time as contest was ended. (Button is pressed 2 seconds after end of contest.)				Contest timer is stopped automatically with a buzzer sound.  Osaekomi is considered to have started at the same time as contest was ended, and osaekomi timer starts counting.	 (Buzzer)

\*1. Even if osaekomi has started at the same time as the contest time was over and the timer was stopped with a buzzer sound, “osaekomi” button is enabled for 5 seconds after the contest was ended, or until  button is pressed, whichever is earlier.



## 4-6 TENNIS

(1) Items shown on the display panel:

- ① Points of player on each side are displayed.  
(Point display for both players can be adjusted independently.)
- ② A mark is lighted to indicate the player to serve.
- ③ A mark is light to indicate 1st or 2nd serve.
- ④ Games and sets won by the player on each side are displayed.

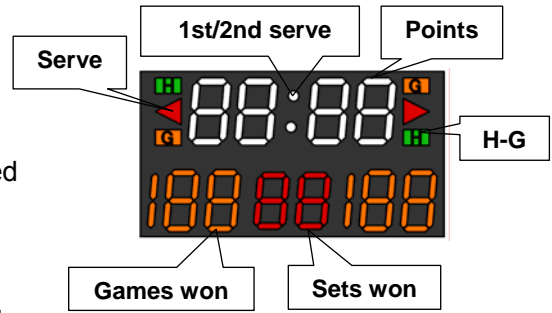





### • Operation Procedure: Point Display

	Operation	Timer section	2nd timer section	Section for points, etc.	Action/Remarks	Display monitor
1	Select "Tennis".					
2	To increase points				Points are increased in order of 0→15→30→40. After "40",  button will not change points. Press  button to reset points of both sides to "0".	→  →
3	In case of deuce				button for player having gained advantage will not change points. Press  button to reset points of both sides to "0".	→  →
4	To clear points				Points of both sides are reset to "0".	
5	In case of tie-break				Tie-break display appears only before a new game is started. Press "Tie-Break" button immediately after pressing  button.	→

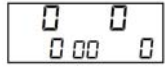

### • Operation Procedure: Games-Won Display

	Operation	Timer section	2nd timer section	Section for points, etc.	Action/Remarks	Display monitor
1	To increase games won					→
2	To clear games won				Games won of both sides are reset to "0".	

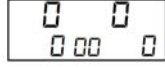
● Operation Procedure: Sets-Won Display

	Operation	Timer section	2nd timer section	Section for points, etc.	Action/Remarks	Display monitor
1	To increase sets won					
2	To clear sets won				Sets won of both sides are reset to "0".	
3	To end the match				Display for a new match appears. Points, sets won, and games won of both sides are all reset to "0".	

● Operation Procedure: 1st/2nd Serve Display

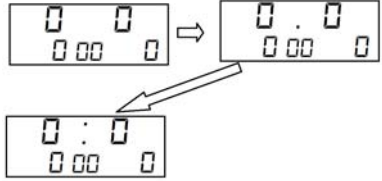
	Operation	Timer section	2nd timer section	Section for points, etc.	Action/Remarks	Display monitor
1	To indicate 1st or 2nd serve To turn off indication				With each press of  button, colon mark on upper row changes in order of ". " → " : " → blank. With each press of  button, colon mark on upper row changes in order of " : " → ". " → blank.	

\*1. For the operation of Serve, Court Change, and "H"- "G" displays, refer to "4-4 Volleyball".

## 4-7 Soft Tennis

(1) Items shown on the display panel:

- ① Points of player on each side are displayed.
- ② A mark is lighted to indicate the player to serve.
- ③ A mark is light to indicate 1st or 2nd serve.
- ④ Games won by player on each side are displayed.

(2) Items that can be adjusted:

- ① The number of points at which Advantage mark is displayed can be adjusted as desired (for games before final and final game).

\* For the default settings, refer to 4-14 of this manual.

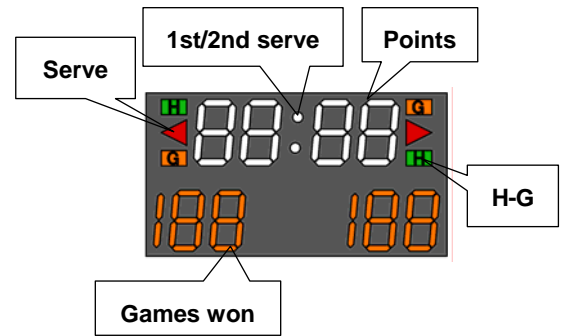

### ■ Confirmation of Settings for Points at Which Advantage Mark is Displayed/ Method of Adjustment

	Operation	Timer section	2nd timer section	Section for points, etc.	Action/Remarks	Display monitor
1	To activate setting mode					
2	Points at which Advantage mark is shown in games before final can be adjusted.					
3	To register setting, and move to final game setting					
4	Points at which Advantage mark is shown in final game can be adjusted.					
5	To register setting, and change over to game mode					

### ● Operation Procedure: Point Display

	Operation	Timer section	2nd timer section	Section for points, etc.	Action/Remarks	Display monitor
1	Select Soft Tennis.					
2	To increase points in games before final				 Press  button to reset points of both sides to "0".	
3	To change over display to final game				Operation can be made at any time during game.	"F" is shown on display monitor only.
4	To increase points in final game				Operate buttons in the same manner as in games before final.	
5	To clear points				Final game display returns to display for games before final.	

\*1. For the operation of Serve, Court Change, and "H"-"G" displays, refer to "4-6 Tennis".

## 4-8 Boxing

(1) Items shown on display panel:

- ① Round time, time to sound end-of-round warning buzzer, interval time, and time to sound end-of-interval warning buzzer are displayed in the timer section.
- ② Round No. is displayed.
- ③ Program code representing the program item shown is displayed.

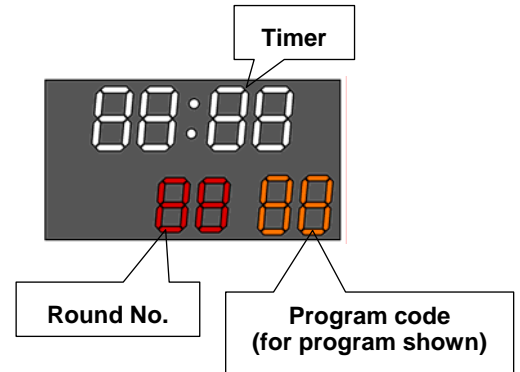

(2) Items that can be adjusted:

- ① Round time, time to sound end-of-round warning buzzer, interval time, and time to sound end-of-interval warning buzzer can be programmed into memory. They have the following program code:  
Round time: P1, time to sound end-of-round warning buzzer: b1, interval time: P2, and time to sound end-of-interval warning buzzer: b2
- ② The number of rounds can be set as desired (up to 99).  
If "0" is set for the number of rounds, the round continues endlessly.
- ③ The color of the digits indicating Round No. can be selected from red and green.







\* For the default settings, refer to 4-14 of this manual.

- Method of Confirmation/Adjustment of Settings: (Ex.: Round time: 3 minutes, time to sound end-of-round warning buzzer: 30 seconds before end, interval: 1 minute, and time to end-of-interval warning buzzer: 5 seconds before end)

	Operation	Timer section	2nd timer section	Section for points, etc.	Action/Remarks	Display monitor
1	To activate setting mode					
2	To set round time (P1) to 3 minutes, and register setting				Time to sound end-of-round buzzer (b1) appears.	
3	To set time to sound end-of-round buzzer (b1) to 30 seconds, and register setting				Interval time (P2) appears.	
4	To set interval time (P2) to 1 minute, and register setting				Time to sound end-of-interval buzzer (b2) appears.	
5	To set time to sound end-of-interval buzzer (b2) to 5 seconds					
6	Number of rounds can be adjusted.					
7	Color of round display can be selected.				Color of round display changes alternately between red and green.	Color of round on display monitor remains the same. Color of LED on display panel will change.
8	To register settings, and change over to game mode					

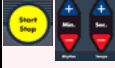
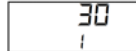
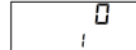
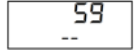
\*1. With each press of button while in the setting mode, the timers can be set to count upward (UP) and downward (DOWN) alternately. Note that the round No. is counted only upward.

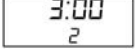
- Operation Procedure: (Ex.: Round time: 3 minutes, time to sound end-of-round warning buzzer: 30 seconds before end, interval: 1 minute, and time to end-of-interval warning buzzer: 5 seconds before end)

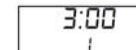
	Operation	Timer section	2nd timer section	Section for points, etc.	Action/Remarks	Display monitor
1	To start round timer of Round 1				Counting is started with a buzzer sound	 (Buzzer)
2	To stop round timer To adjust round time					
3	When time to sound end-of-round warning buzzer is reached				Warning buzzer rings 30 seconds before end of round	 (warning buzzer)
4	End of Round 1/ Start of interval timer				Buzzer sounds at the same time as Round 1 ends, and interval timer starts counting automatically.	 (Buzzer) → 
5	When time to sound end-of-interval warning buzzer is reached/ End of interval/ Start of Round 2				Warning buzzer rings 5 seconds before end of interval. At the same time as interval ends, buzzer sounds and round timer starts counting for Round 2.	 (Warning buzzer) →  (Buzzer)
6	End of match Number of rounds set have been finished.				Timer stops automatically with a buzzer sound.	 (Buzzer)
7	To show display for a new match				Display is reset to the settings you made initially.	

## 4-9 Programmable Timer

\* This function is convenient for various types of training including interval training.

(1) Items shown on display panel:

- ① Timer that counts from 0 up to 99 minutes 59 seconds is displayed.
- ② The number of times the programs are repeated is displayed.
- ③ Program No. is displayed.
- ④ The last program can be canceled, and in that case, "-P" is displayed instead of "P", which is displayed during ordinary program cycles.

(2) Items that can be adjusted:

- ① Up to 20 programs can be contained in 1 program cycle.
- ② The number of times the programs are repeated can be set as desired (up to 199 times).  
If the number of times repeated is set to "0", the programs are repeated endlessly.

\* For the default settings, refer to 4-14 of this manual.

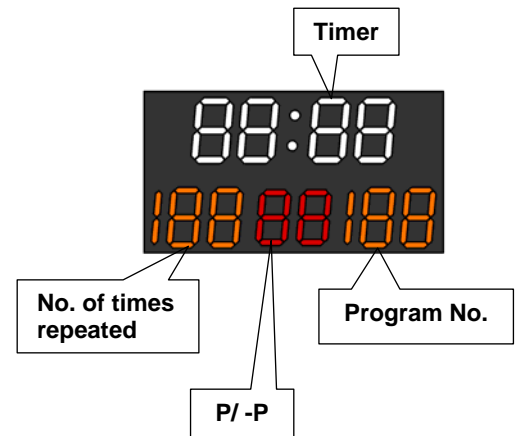





■ Method of Confirmation/Adjustment: (Ex.: Program 1: 5 minutes and 30 seconds → Program 2: 3 minutes and 20 seconds, number of times repeated: 15 times)

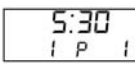
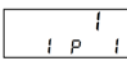

	Operation	Timer section	2nd timer section	Section for points, etc.	Action/Remarks	Display monitor
1	To activate setting mode					
2	To set time of Program 1 To register time of Program 1, and move to Program 3 setting				Ex.: 5 minutes and 30 seconds	
3	To set time of Program 2 To register time of Program 2, and move to Program 3 rhythm setting				Ex.: 3 minutes and 20 seconds	
4	*1. To set Program 3 and more programs, follow the above steps. *2. Once "0:00" is set for the time of a Program during the setting mode, setting procedure of the rest of the Programs will be cancelled.					
5	To set number of times repeated				Ex.: 15 times	
6	To register settings, and change over to timer mode					

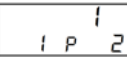
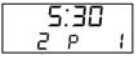
\*1. With each press of button while in the setting mode, the timers can be set to count upward (UP) and downward (DOWN) alternately. Note that the number of times repeated is counted only upward.

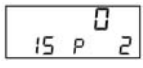
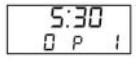
- Operation Procedure: Start of Timer (Ex.: Program 1: 5 minutes and 30 seconds→Program 2: 3minutes and 20 seconds, number of times repeated: 15 times)

	Operation	Timer section	2nd timer section	Section for points, etc.	Action/Remarks	Display monitor
1	To start Program 1				Counting is started with a buzzer sound	 (Buzzer)
2	End of Program 1/ Start of Program 2				At the same time as Program 1 ends, Program 2 starts counting with a buzzer sound.	 ⇒  (Buzzer)
3	To stop Program To adjust Program time					
4	End of Program 2/ Start of Program 1 for 2nd time				At the same time as Program 2 ends, Program 1 starts counting for 2nd time with a buzzer sound.	 ⇒  (Buzzer)
5	When all Programs are completed as designated, display returns to Program 1 before start.				Timer is automatically stopped with a buzzer sound, and display returns to settings you made initially.	 ⇒  (Buzzer)

- Operation Procedure: To End Program Cycles without Counting the Last Program (To skip Program 2 in the 15th cycle when 15 is set for the number of times repeated)

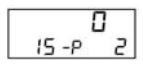
	Operation	Timer section	2nd timer section	Section for points, etc.	Action/Remarks	Display monitor
1	To cancel last Program					 “-” is added before “P”.
2	When cancellation of last Program is engaged				After Program 2 is counted for 15 times, timer stops automatically with a buzzer sound.	 (Buzzer)

## 4-10 Pace Setter

\* By setting rhythm and tempo, pace setter sound can be given out. This function is convenient for various types of training.

(1) Items shown on display panel:

- ① Rhythm and tempo you have set are displayed.
- ② The number of times the tempo sound/indication is repeated is displayed.
- ③ ◀ marks on both sides of the display panel visually indicate the tempo.

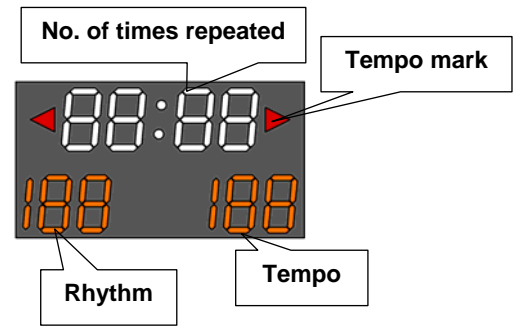

(2) Items that can be adjusted:

- ① Rhythm and tempo can be set as desired.
- ② The number of times the tempo sound/indication is repeated can be set up to 9,999 times. If such number of times is set to "0", the sound is given out endlessly.

\* For the default settings, refer to 4-14 of this manual.

\* The pace setter sound (buzzer sound) rings in one tone irrespective of the rhythm and tempo setting, and cannot be silenced.

■ Method of Confirmation/Adjustment (Ex.: Rhythm: 2 [simple duplet time], tempo: 120 times/minute, number of times repeated: 240 times, display of number of times repeated: counted upward)

	Operation	Timer section	2nd timer section	Section for points, etc.	Action/Remarks	Display monitor
1	To activate setting mode					
2	To set rhythm and tempo (simple duplet time and 120 times/minute) To set number of times repeated (240 times)	 Rhythm Tempo				
3	To register settings, and change over to pace setter function					

\*1. With each press of button while in the setting mode, the display of number of times the tempo sound/indication is repeated can be set to count upward (UP) and downward (DOWN) alternately.

\*2. Setting ranges of rhythm, tempo and number of times the tempo sound/indication is repeated are 1 ~ 9, 30 ~ 255, and 1 ~ 9999, respectively.

\*3. If more than 200/minute is set for the tempo, the lower half of the segments of the hundreds digit of the tempo display is lighted on the display panel.

● Operation Procedure: (Ex.: Rhythm: 2 [simple duplet time], tempo: 120 times/minute, number of times repeated: 240 times, display of number of times repeated: counted upward)

	Operation	Timer section	2nd timer section	Section for points, etc.	Action/Remarks	Display monitor
1	To start Pace Setter				Buzzer sounds according to set rhythm and tempo. marks on both sides of display panel light up alternately.	
2	To change rhythm and tempo	 Rhythm Tempo				
3	To stop pace setter sound/ To change number of times repeated				Number of times repeated can be changed while pace setter is stopped.	
4	Tempo sound/indication has been repeated set number of times.				Pace Setter stops automatically with a buzzer sound.	
5	To use Pace Setter newly				Display is reset to settings you made initially.	



## 4-11 Stopwatch

(1) Items shown on display panel:

- ① Up 199 hours, 59 minutes, and 59 seconds 99 can be measured and displayed.
- ② The times of the first and second runners, and the first and second lap times are measured and displayed.
- ③ Lap time (LP)/split time (SP) marks are displayed.

(2) Items that can be adjusted:

- ① Display can be changed over between lap time (LP) and split time (SP) displays.

\* For the default settings, refer to 4-14 of this manual.

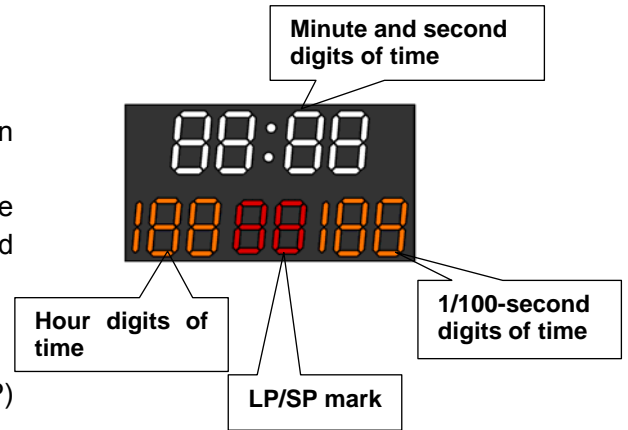

### ■ Method of Confirmation/Adjustment: Changeover between Lap and Split time displays

	Operation	Timer section	2nd timer section	Section for points, etc.	Action/Remarks	Display monitor
1	Select Stopwatch.					"LP" is shown on display monitor only.
2	Display can be changed over between lap and split time displays.					"SP" is shown on display monitor only.

\*1. Changeover of displays between lap and split times can be made even while the stopwatch measurement is in progress. By pressing button, "LP" and "SP" appears and disappears alternately, and the corresponding measurement is displayed.

### ● Operation Procedure: To Measure Elapsed Time (Standard Measurement)

	Operation	Timer section	2nd timer section	Section for points, etc.	Action/Remarks	Display monitor
1	Select Stopwatch.				Either lap or split time display can be used.	"LP" is shown on display monitor only.
2	To start Stopwatch				Measurement is started.	"LP" is shown on display monitor only.
3	To stop Stopwatch (Ex.: 18 seconds 08)				Measurement is stopped.	"LP" is shown on display monitor only.
4	To reset Stopwatch				Stopwatch is reset to "0".	"LP" is shown on display monitor only.

\*1. After measuring 199 hours, 59 minutes, and 59 seconds 99, the Stopwatch continues measurement from "0".

### ● Operation Procedure: To Measure Split Time (SP)

	Operation	Timer section	2nd timer section	Section for points, etc.	Action/Remarks	Display monitor
1	Select split time display.					"SP" is shown on display monitor only.
2	To start Stopwatch				Measurement is started.	"SP" is shown on display monitor only.
3	To measure split time (Ex.: 26 minutes and 13 seconds 08)				Measured split time (not in progress) is displayed, and "SP" flashes. *Measurement is continued internally.	"SP" flashes on both display monitor and display panel.
(4)	Display can be changed over to lap time as required.				Lap time is displayed, and "LP" flashes.	"LP" flashes on both display monitor and display panel.
(5)	To return to split time display				Split time is displayed, and "SP" flashes.	"SP" flashes on both display monitor and display panel.







6	To release split time (Ex.: 28 minutes and 32 seconds 56)				Total time measurement in progress is displayed.	⇒  ⇒ "SP" is shown on display monitor only
7	To stop Stopwatch (Ex.: 2 hours, 20 minutes and 23 seconds 72)				Stopwatch is stopped.	⇒ "SP" is shown on display monitor only.
8	To reset Stopwatch				Stopwatch is reset to "0".	 "SP" is shown on display monitor only.

● Operation Procedure: To Measure Times of First and Second Runners



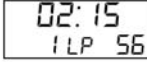

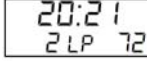
	Operation	Timer section	2nd timer section	Section for points, etc.	Action/Remarks	Display monitor
1	Select split time display.					 "SP" is shown on display monitor only.
2	To start Stopwatch				Measurement is started.	 "SP" is shown on display monitor only.
3	To measure time of 1st runner (Ex.: 26 minutes and 13 seconds 08)				Time of 1st runner (not in progress) is displayed, and flashing "SP" is shown. *Measurement is continued internally.	 "SP" flashes on both display monitor and display panel.
4	To measure time of 2nd runner				Time of 1st runner (not in progress) is displayed, and "SP" (not flashing) is shown. *Measurement is continued internally.	 "SP" is shown on both display monitor and display panel.
5	To display time of 2nd runner (Ex.: 28 minutes and 32 seconds 56)				Time of 2nd runner is displayed instead of that of 1st.	 "SP" is shown on both display monitor and display panel.
6	To reset Stopwatch				Stopwatch is reset to "0".	 "SP" is shown on display monitor only.

● Operation Procedure: To Measure Lap Time

	Operation	Timer section	2nd timer section	Section for points, etc.	Action/Remarks	Display monitor
1	Select lap time display.					 "LP" is shown on display monitor only.
2	To start Stopwatch				Measurement is started.	 "LP" is shown on display monitor only.
3	To measure 1st lap time (Ex.: 26 minutes and 13 seconds 08)				1st lap time (not in progress) is displayed, and flashing "LP" is shown. *Measurement is continued internally.	 "LP" flashes on both display monitor and display panel.
4	To release lap time (Ex.: 28 minutes and 32 seconds 56)				Total time measurement in progress is displayed.	⇒  ⇒ "LP" is shown on display monitor only.
5	To measure 2nd lap time (Ex.: 23 minutes and 9 seconds 27)				2nd lap time (not in progress) is displayed, and flashing "LP" is shown. *Measurement is continued internally.	 "LP" flashes on both display monitor and display panel.
(6)	Display can be changed over to split time as required.				Split time is displayed. Flashing "SP" is shown.	 "SP" flashes on both display monitor and display panel.

(7)	To return to lap time display				2nd lap time is displayed, and flashing "LP" is shown.		"LP" flashes on both display monitor and display panel.
8	To release lap time (Ex.: 1 hour, 2 minutes and 15 seconds 56)				Total time measurement in progress is displayed.	⇒  ⇒ 	"LP" is shown on display monitor only.
9	To stop Stopwatch (Ex.: 2 hours, 20 minutes and 21 seconds 72)				Stopwatch is stopped.		"LP" is shown on display monitor only.
10	To reset Stopwatch				Stopwatch is reset to "0".		"LP" is shown on display monitor only.

● Operation Procedure: When Lap Time is Not Released in Step 8 above But Measurement is Stopped

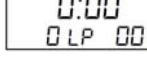
	Operation	Timer section	2nd timer section	Section for points, etc.	Action/Remarks	Display monitor	
1	To measure 3rd lap time and stop Stopwatch				3rd lap time is displayed, and Stopwatch is stopped.	⇒ 	"LP" is shown on both display monitor and display panel.
2	To show total time (Ex.: 2 hours, 20 minutes and 21 seconds 72)				Total time is displayed.		"LP" is shown on both display monitor and display panel.
3	To reset Stopwatch				Stopwatch is reset to "0".		"LP" is shown on display monitor only.

\*1. The figure below illustrates the concept of split and lap times:

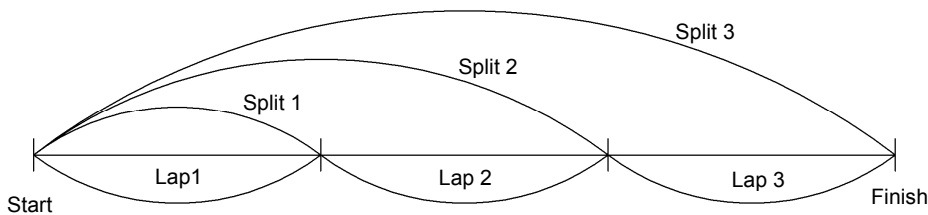

Split time: Time that has elapsed from the start of an activity to any given stage.

Lap time: Time that has elapsed from the start of one stage of an activity to that of the next stage.

## 4-12 Timer (with Warning Buzzer)

(1) Items shown on display panel:

- ① Timer counts down the set time, or counts up from "0" to the set time.
- ② Timer can be set to count down or up in 1/10 second increments.
- ③ The warning buzzer can be programmed to ring at the designated time, and the program No. is shown on the display while it is engaged.

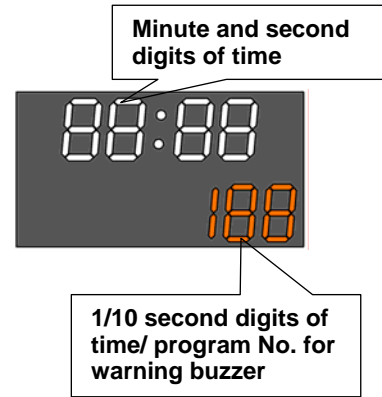

(2) Items that can be adjusted:

- ① Any desired amount of time up to 99 minutes and 59 seconds can be set for the Timer.
- ② The warning buzzer can be programmed to ring at up to 9 different designated times.

\* For the default settings, refer to 4-14 of this manual.

### ■ Method of Confirmation/Adjustment of Settings (Ex.: Timer time: 10 minutes and 30 seconds, Program 1 for warning buzzer: 1 minute and 30 seconds)

	Operation	Timer section	2nd timer section	Section for points, etc.	Action/Remarks	Display monitor
1	To activate setting mode					
2	To register timer time, and move to Program 1 setting				Ex.: 10 minutes and 30 seconds	
3	To register Program 1 for warning buzzer, and move to Program 2 setting				Ex.: 1 minute and 30 seconds	
4	*1. To set Program 3 and more programs, follow the above steps. *2. Once "0:00" is set for the time of a Program during the setting mode, setting procedure of the rest of the Programs will be cancelled.					
5	To register settings, and change over to Timer display					

\*1. With each press of button while in the setting mode, the Timer can be set to count upward (UP) and downward (DOWN) alternately.

\*2. By pressing button, the Timer counts in 1/10 second increments instead of 1 second increments (default setting). This button operation can be made even while the Timer is counting.

### ● Operation Procedure: Start of Timer (Ex.: Timer time: 10 minutes and 30 seconds, Program 1 for warning buzzer: 1 minute and 30 seconds, counting in 1/10 second increments)

	Operation	Timer section	2nd timer section	Section for points, etc.	Action/Remarks	Display monitor
1	To start Timer				Timer starts counting.	
2	When designated time of Program 1 is reached				Warning buzzer rings automatically.	(Warning buzzer)
3	When set time is up/ To reset Timer				Timer stops automatically with a buzzer sound. Display is reset to settings you made initially.	(Buzzer)

### Examples of Displays When Timer is Counting Up and Down (Ex.: Timer time: 5minutes and 30 seconds, counting in 1/10 second increments)

	Before start		During counting		Time-up
Counting up		→	→	→	
Counting down		→	→	→	

## 4-13 Clock & Alarm

\* The Clock indicates the current time in 24-hour indication system.

(1) Items shown on display pane:

① Hour, minutes and seconds are displayed.

(2) Items that can be adjusted.

① Alarm can be set to ring at a designated time.

② Alarm can be programmed to ring at up to 5 different times.

\* For the default settings, refer to 4-14 of this manual.

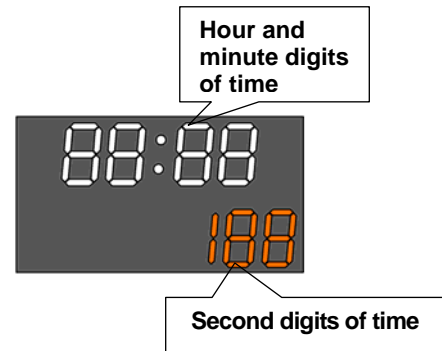

### ■ Method of Confirmation/Adjustment of Settings: Time Setting (Ex.: 10 minutes past 10 o'clock)

	Operation	Timer section	2nd timer section	Section for points, etc.	Action/Remarks	Display monitor
1	Select Clock & Alarm					
2	To set hour, minute and second digits				"Min.": for Hour setting "Sec.": for Minute setting "1/10 sec.": for Second setting	
3	To start Clock				Clock starts indicating time.	

### ■ Method of Confirmation/Adjustment of Settings: Alarm Time Setting (Ex.: 55 minutes past 11 o'clock)

	Operation	Timer section	2nd timer section	Section for points, etc.	Action/Remarks	Display monitor
1	Select Clock & Alarm					
2	To register alarm time of Program 1, and move to Program 2 setting				"Min.": for Hour setting "Sec.": for Minute setting	→
3	*1. To set Program 2 and more programs, follow the above steps.					
4	To register settings, and change over to Clock display					

\*1. Once the Clock has been set and started, it continues operating even while the alarm setting procedure is performed.

### ■ Method of Confirmation/Adjustment of Settings: To Cancel Alarm Program

	Operation	Timer section	2nd timer section	Section for points, etc.	Action/Remarks	Display monitor
1	To cancel Alarm Program					
2					By blanking out hour and/or minute digits, Program is cancelled.	→  or  or

\*1. Even if one Program is cancelled, other Programs will not be cancelled, and they are still engaged as you have set. (Cancellation of Program "b1" will not cancel Program "b2".)



\*2. The Alarm Programs (up to 5 Programs) you have set can be checked by pressing button.

\*3. The Clock continues operating internally while other events/functions are used and the respective displays are shown.

\*4. The Alarm Programs you have set are retained even if other events/functions are used. However, the Alarm will not sound at the designated time while events/functions other than Clock & Alarm are in use.

\*5. The time set for the Clock and the Alarm Programs will be cleared if the power is turned off.

#### 4-14 Factory Default Settings (Initial Setting) of Each Event/Function

- \*1. To reset the current settings of the event/function in use to the default settings, keep  button pressed for 2 seconds. The current settings of the event/function in use will all be cleared and reset to the default settings programmed at the factory.
- \*2. By turning on the power while  button is kept pressed, all the settings of all the events/functions will be reset to the factory default settings. LEDs on the front display panel and the display monitor flash for 3 seconds to indicate that resetting has been completed.
- \*3. Only the default settings that can be adjusted as necessary are listed below.

NO.	Event/Function	Default Setting		NO.	Event/Function	Default Setting					
1	Basketball (24-Sec. Timer)	Program 1 (P1)	10 min.	4	Volleyball	Interval time	2 分				
		Program2 (P2)	2 min.			Count-down or -up	Count-down				
		Program 3 (P3)	10 min.			Time to ring end-of-interval warning buzzer (P1 ~ P9)	Not set				
		Program 4 (P4)	10 min.			Timeout time	30 sec.				
		Program 5 (P5)	10 min.			LED color of timeout time	Green				
		Program 6 (P6)	2 min.			LED color of 1st/2nd serve	Green				
		Program 7 (P7)	10 min.			Contest time	5 min.				
		Program 8 (P8)	Not set			Count-down or -up	Count-down				
		Program 9 (P9)	Not set			Osaekomi time	25 sec.				
		1/10 or 1 sec. increments	1/10 sec.			Osaekomi time (when waza-ari is awarded)	20 sec.				
		Count-down or -up	Count-down			6	Tennis	—	—		
24 or 30 sec.	24 sec.	7	Soft Tennis	Points at which advantage mark is displayed: before final game	4						
LED color of 24	Red			Points at which advantage mark is displayed: final game	7						
2	Basketball (Timeout Timer)			Program 1 (P1)	10 min.	8	Boxing	Round time	3 min.		
				Program2 (P2)	2 min.			Count-down or -up	Count-down		
				Program 3 (P3)	10 min.			Time to ring end-of-round warning buzzer	Not set		
				Program 4 (P4)	10 min.			Number of rounds	3		
				Program 5 (P5)	10 min.			LED color or rounds	Red		
				Program 6 (P6)	2 min.			Interval time	1 min.		
				Program 7 (P7)	10 min.			Time to ring end-of-interval warning buzzer	Not set		
				Program 8 (P8)	Not set			9	Programmable Timer	Program (P1 ~ P20)	Not set
				Program 9 (P9)	Not set					Timer	Not set
		1/10 or 1 sec. increments	1/10 sec.	Count-down or -up	Count-down						
		Count-down or -up	Count-down	Number of times repeated	Not set						
Timeout time	60 sec.	10	Pace Setter	Rhythm	2 (duplet time)						
LED color of timeout time	Green			Tempo	120 times/min.						
3	Basketball (Team Foul)			Program 1 (P1)	10 min.	Number of times repeated	Not set				
				Program2 (P2)	2 min.	Count-down or -up	Count-up				
		Program 3 (P3)	10 min.	11	Stopwatch	LP orSP	LP				
		Program 4 (P4)	10 min.	12	Timer (with warning buzzer)	Timer	Not set				
		Program 5 (P5)	10 min.			1/10- or 1 sec. increments	1 sec.				
		Program 6 (P6)	2 min.			Count-down or -up	Count-down				
		Program 7 (P7)	10 min.			Time to ring warning buzzer	Not set				
		Program 8 (P8)	Not set	13	Clock & Alarm	Current time	Not set				
		Program 9 (P9)	Not set			Alarm time	Not set				
		1/10 or 1 sec. increments	1/10 sec.								
		Count-down or -up	Count-down								
LED color of number of team fouls: 0 ~ 4	Green										
LED color of number of team fouls: 5 or more	Red										



## 5. HOW TO USE INFRARED WIRELESS REMOTE CONTROLLER

1. To register or adjust the programs or other settings, operate the buttons on the operation panel.
2. The table below shows the correspondence between the operations performed by buttons A ~ J of the wireless remote controller and buttons 1 ~ 25 of the operation panel. (Note that the table below refers to the operations performed by the wireless remote controller from the front side of the Sports Counter.)

No.	Event/Function	Buttons of Wireless Remote Controller									
		A	B	C	D	E	F	G	H	I	J
1	Basketball (24-Sec. Timer)	10	24	25	9	23	22	20	19	17	16
2	Basketball (Timeout Timer)	10	—	—	9	23	22	20	19	17	16
3	Basketball (Team Foul)	10	13	11	9	—	12	20	19	17	16
4	Volleyball	10	15	14	5	23	22	20	19	17	16
5	Judo	10	—	21	9	23	22	—	—	—	—
6	Tennis	10	4	3	5	—	8	20	19	17	16
7	Soft Tennis	10	13	11	5	2	12	20	19	17	16
8	Boxing	10	—	—	9	8	1	—	—	—	—
9	Programmable Timer	—	—	—	9	8	1	—	—	—	—
10	Pace Setter	—	—	—	9	—	1	3	6	4	7
11	Stopwatch	—	24	25	—	23	22	—	—	—	—
12	Timer (with Warning Buzzer)	—	—	—	9	—	1	—	—	—	—
13	Clock & Alarm	—	—	—	9	—	1	—	—	—	—

<Wireless Remote Controller>

<Operation Panel of KT-601>

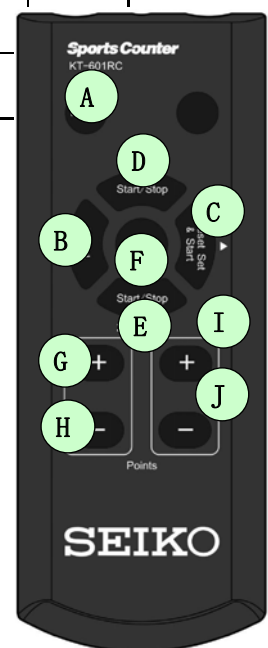

### 3. Accessories of Wireless Remote Controller

- ① Remote controller holder: Double-faced adhesive tape is attached on its rear.

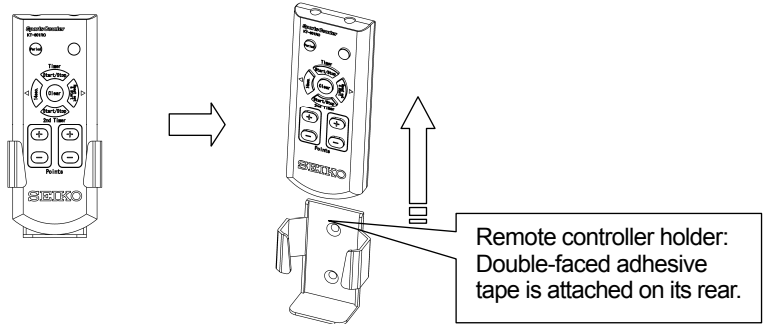

- ② R03/AAA dry battery, 2 pieces:

The batteries included in the remote controller when it was purchased are monitor batteries inserted at the factory for the purpose of checking the performance of the controller. Their lives, therefore, may be shorter than specified, and it is recommended that they be replaced with new ones before the remote controller is used for a sports event.

When inserting new batteries, check that (+) and (-) terminals of R03/AAA dry batteries are properly aligned in the compartment.

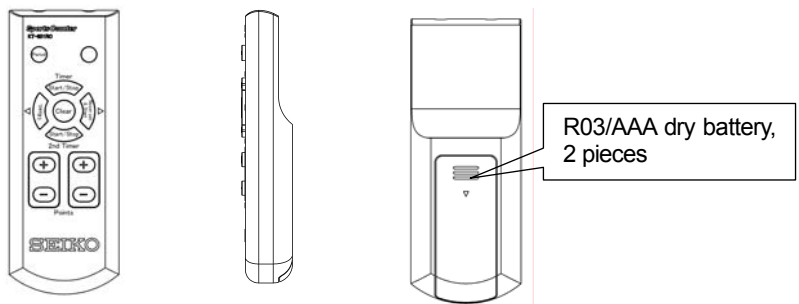

### 4. Standard signal receivable distance from KT-601 to the remote controller :

Approximately 7 m when the controller is used in front of KT-601

Approximately 3 m when the controller is used at the rear of KT-601

Standard effective radiation range:

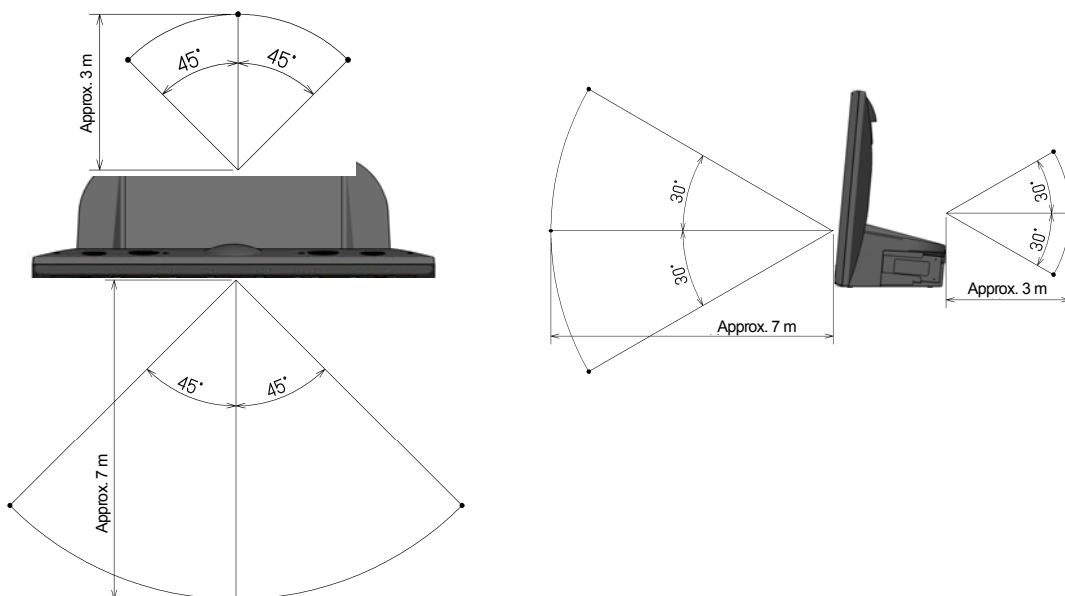

$\pm 45^\circ$  in horizontal direction

$\pm 30^\circ$  in vertical direction





## 6. CONNECTION WITH OTHER DEVICES INCLUDING ANOTHER KT-601

 <h3 style="display: inline;">CAUTION</h3>	
<p>Before connecting the dedicated cables, <u>be sure to turn off the power of all the devices.</u> When turning them on, <u>be sure to turn on the master device first,</u> and if they are connected in a serial manner, <u>turn on other devices one by one in order from the one nearest to the master device.</u> Otherwise, the devices may show abnormal displays or operate improperly. Also, do not use any other cable than specified. A malfunction may result.</p>	
<p>When more than one device is connected to the master device, <u>never connect or disconnect the dedicated cables while the power is on.</u> Otherwise, the devices may show abnormal displays or operate improperly. If such operation was performed by mistake, turn off the power of all the devices, and then, turn them on after at least 5 seconds. In doing so, if they are connected in a serial manner, turn on the master device first, and then, turn on other devices one by one in order from the one nearest to the master device.</p>	

\* When connecting with other devices including another KT-601, select the connection condition using Equipment Connection button .

### ■ Examples of Equipment Connection

#### 6-1 Use of Sports Counter KT-601 as Master Device

① To use KT-601 as a master device:

- Press Equipment Connection button to select “1. Master”.

Display monitor

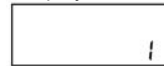

- High-Volume Buzzer BZ-050 (sold separately) and Sports Timer ST-306 (sold separately) can be connected with KT-601.

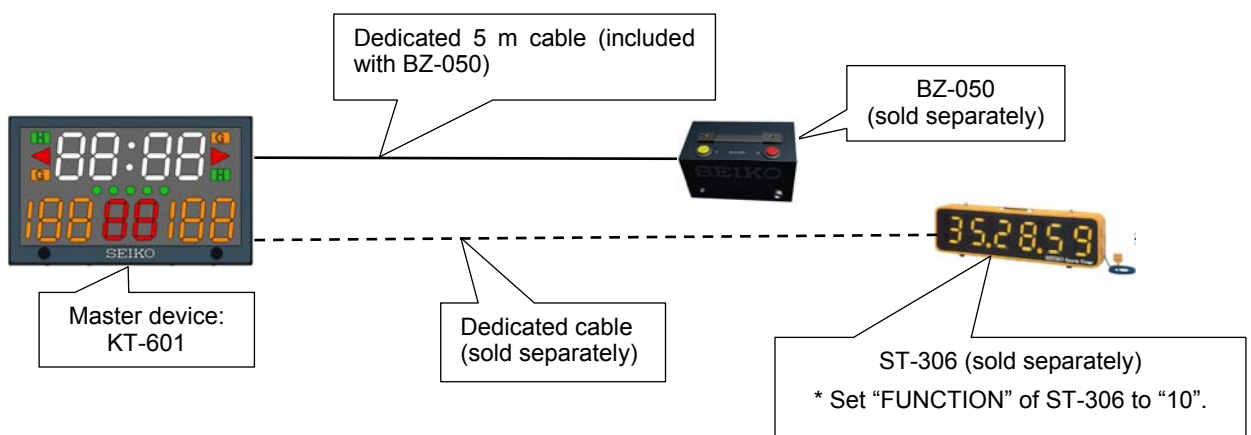

**Note:** For the locations of connectors for connecting above devices, refer to the illustration of “<Rear Side>” in “2. NAMES AND FUNCITONS OF PARTS”.

## 6-2 Receiver/ Sports Counter

- ① To use KT-601 as a master device and connect another KT-601 as a receiver:
- Setting of KT-601 used as a master device: Press Equipment Connection button to select “1. Master”.
  - Setting of KT-601 used as a receiver: Press Equipment Connection button to select “2. Receiver: Sports Counter”. (Up to 4 units of KT-601 can be connected as receivers.)

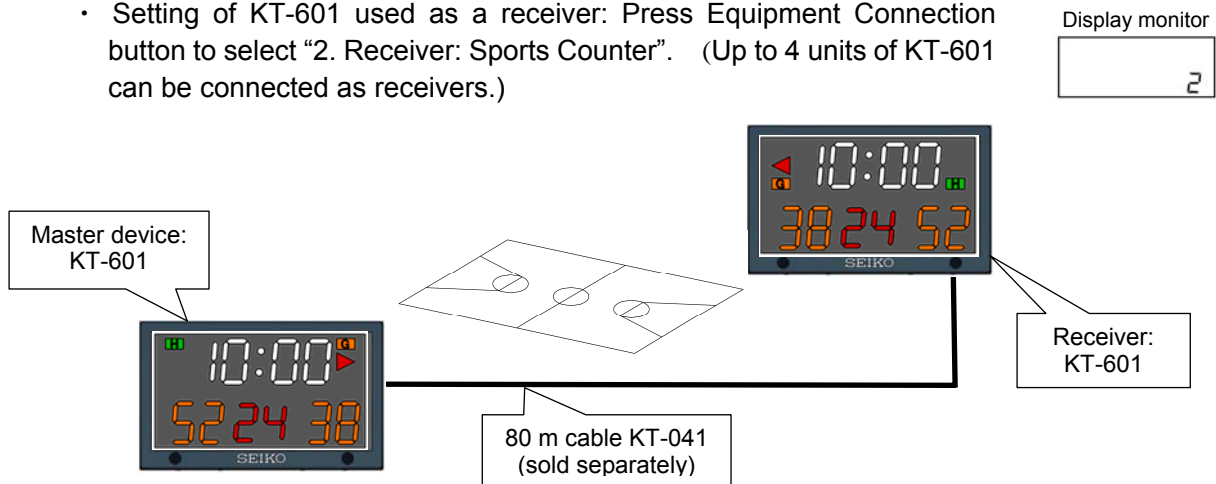

**Note:** The buttons except Court Change button  are disabled on the receiver side. By pressing Court Change button , Points on both ends of the display panel change places.

## 6-3 Receiver/ Sports Printer

- ① To use CT-1000 as a master device and connect KT-601 as a receiver:
- Setting of KT-601 used as a receiver: Press Equipment Connection button to select “3. Receiver/ Sports Printer”.

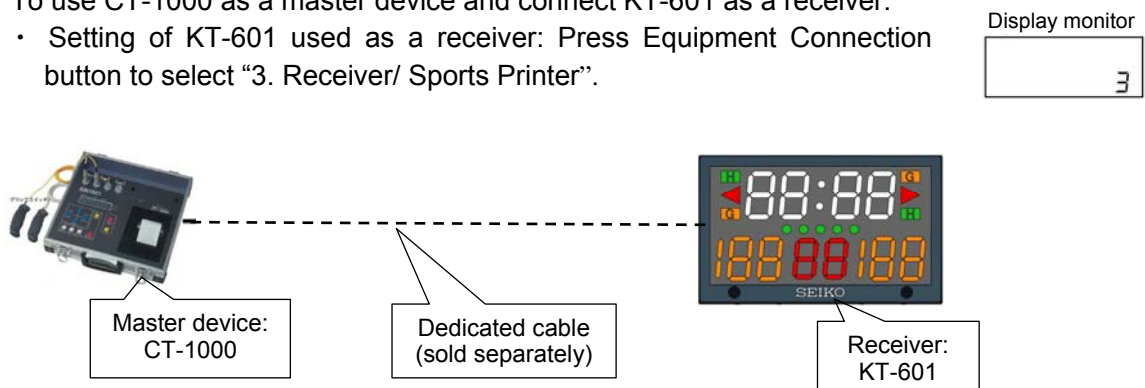

## 6-4 Receiver/ Game Operation Board

- ① To use ST-2000 Series (Operation Board ST2030) as a master device and connect KT-601 as a receiver:
- Setting of KT-601 used as a receiver: Press Equipment Connection button to select “4. Receiver/ Game Operation Board”.

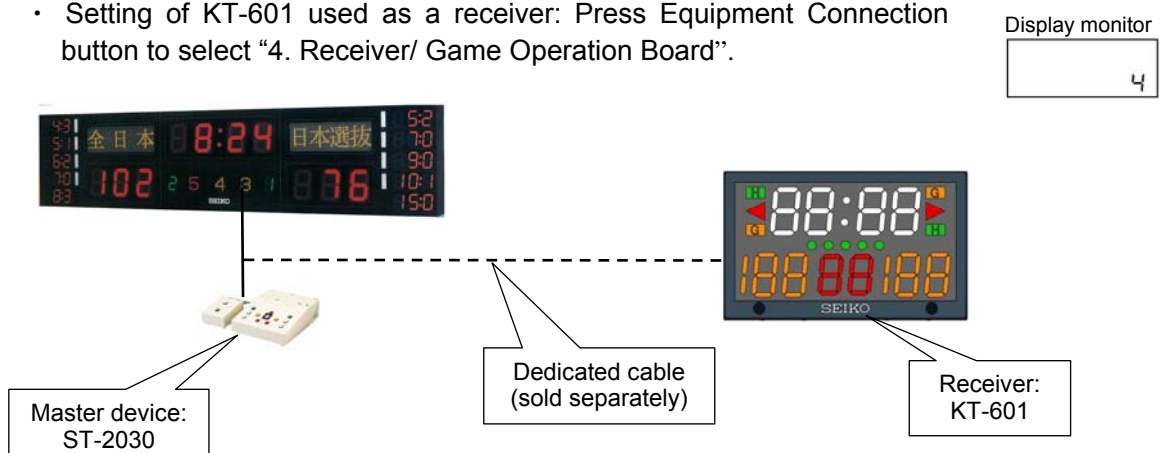



# SEIKO TIME SYSTEMS INC.

URL <http://www.seiko-sts.co.jp>

---

## **GUARANTEE**

Thank you very much for purchasing SEIKO SPORTS COUNTER KT-601.

We certify that the Product is guaranteed against defects in material and workmanship according to the guarantee conditions specified herein.

If the Product malfunctions under normal use as described in this Operating Manual within one year from the date of purchase, it will be repaired without charge.

To qualify for the services under the guarantee, you must present your SEIKO SPORTS COUNTER KT-601 to the retailer from whom it was purchased, or a service facility designated by us. Packaging and transportation charges are to be paid by the owner of the Product.

Even within the guarantee period, repair services will be provided at cost in the following cases:

- (1) Failure or damage caused by misuse or carelessness;
- (2) Failure or damage caused by improper repair or modification;
- (3) Failure or damage caused by improper handling such as dropping of the Product during transportation after purchase;
- (4) Failure or damage caused by natural disasters such as fire, flood, earthquake and lightning, and other factors beyond the control of us such as smoke and other air pollution and extraordinary atmospheric pressure;
- (5) Scratches, cracks or other damage on the case caused by use over time;
- (6) If the name of the retailer and the purchase date are not indicated in the space below, or if such information has been rewritten; and
- (7) If this Guarantee is not submitted together with the Product.

Date of purchase:

Retailer:

Please note that this Guarantee is valid only if the name of the retailer and the date of purchase are properly entered by the retailer from whom your SEIKO SPORTS COUNTER KT-601 was purchased.