



www.gillathletics.com
800-637-3090

730181 - FUSION 4x8 STARTING BLOCK INSTRUCTIONS

Pedal pads are available in the following colors:

- Royal Blue
- Red
- Orange
- Black
- Green

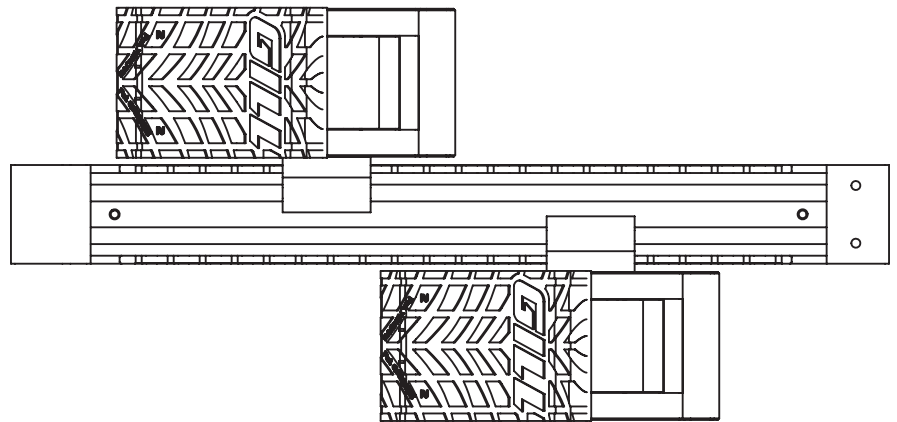
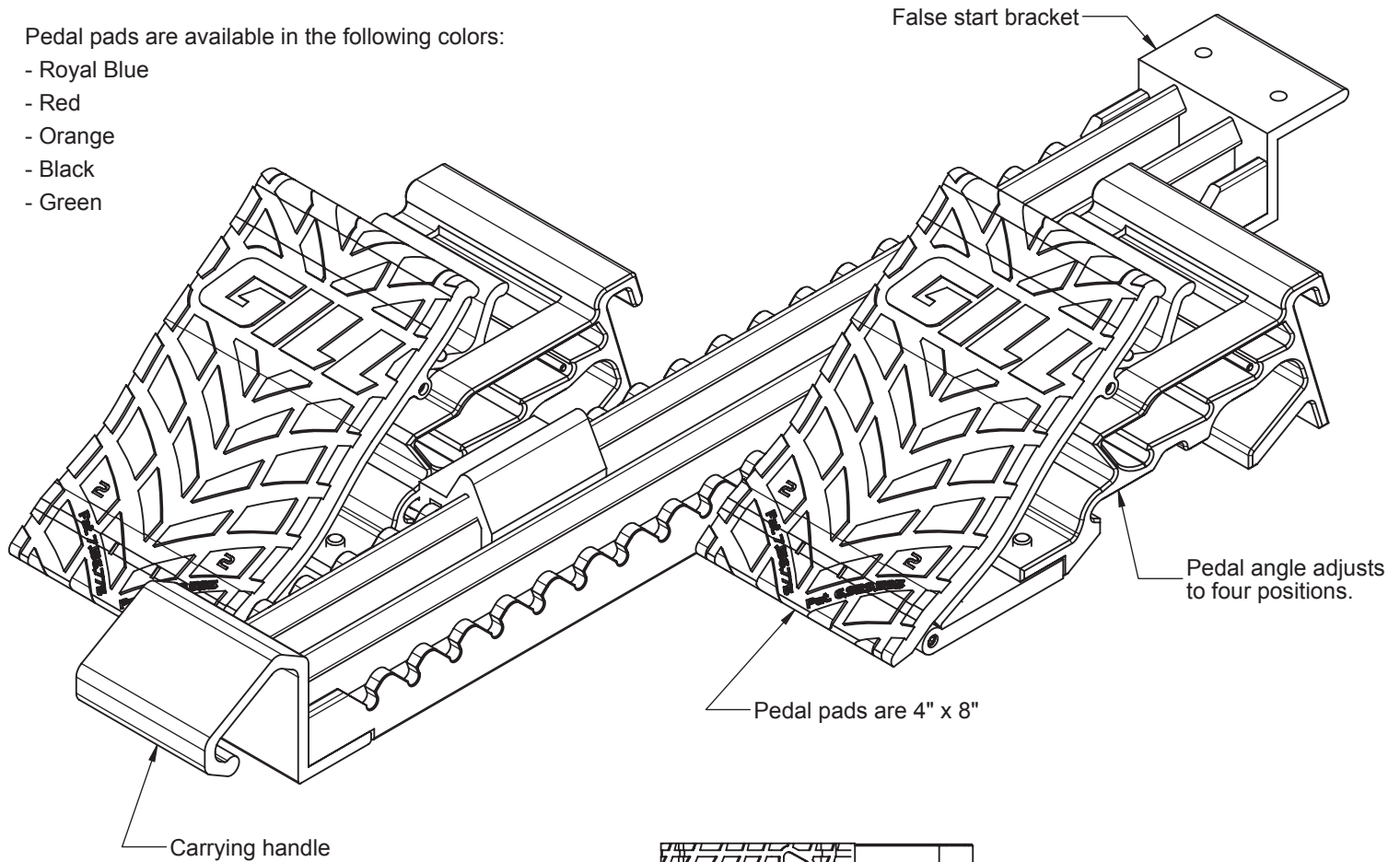

Precise and consistent foot placement is ensured using the integrated pedal markings. Pedals are adjustable to 30°, 40°, 50°, and 60° settings. Angled spikes in the base of the pedals guarantee a start with absolutely no slipping. Built in handle allows for easy carriage.

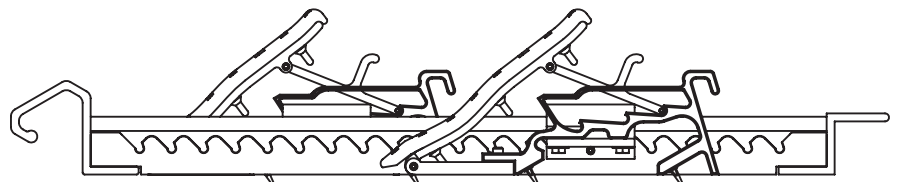
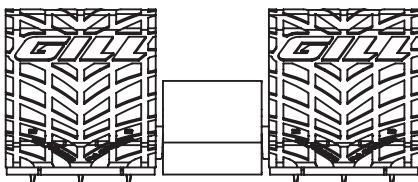



www.gillathletics.com
800-637-3090

730181 - FUSION 4x8 STARTING BLOCK INSTRUCTIONS

The FUSION starting block is shipped unassembled.

The following tools are needed:

- Needle Nose Pliers
- Spike Wrench
- Allen Key (provided)

1. Pedal pads

Set the angle of the pedal to the 60 position.

Insert the tabs on the pedal pad into the holes in the pedal plate.

Use one hand to press on the pedal pad. Use the other hand to gently pull the tabs through the holes with needle nose pliers. Gently wiggle the tab to help it through the hole. Be careful not to pull the tab off of the pedal pad.

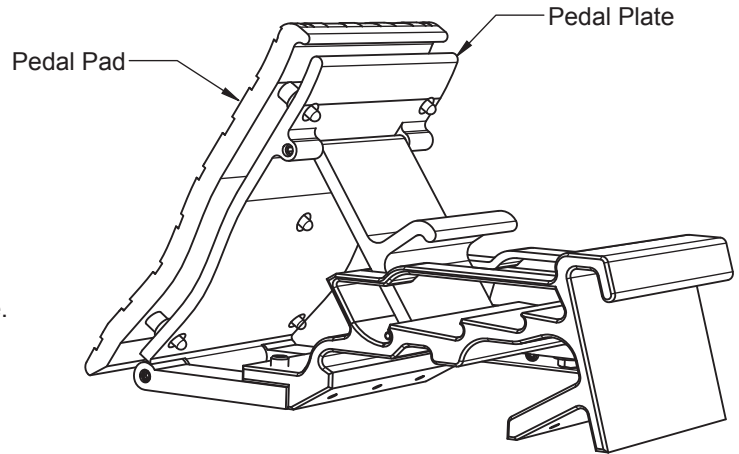

2. False start bracket

Fasten the false start bracket to the back of the rail with the flat head screw provided.

Make sure that the "teeth" of the rail are pointing away from the false start bracket.

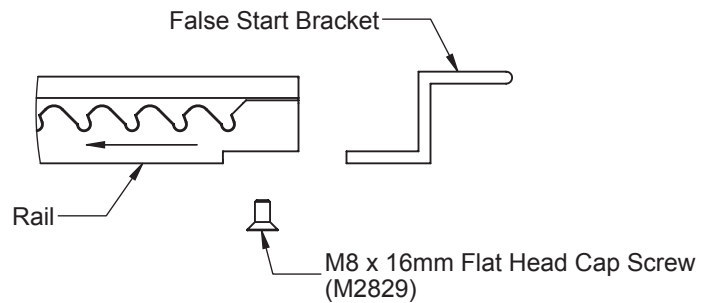

3. Pedals

Slide each pedal onto the rail so that the pedal pad is facing towards the open end of the rail.

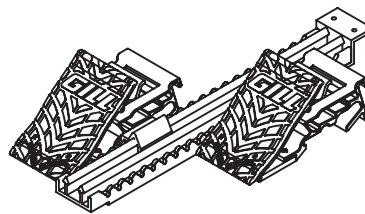

4. Handle

Fasten the handle to the front of the rail with the flat head screw provided.

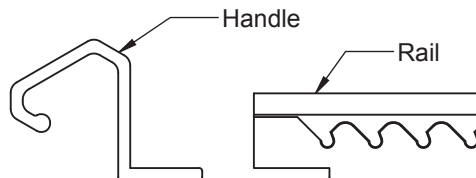

5. Spikes

Flip the starting block over and install the spikes into the bottom of each pedal.

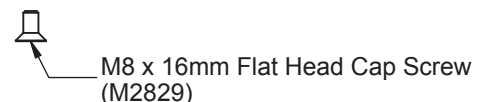



www.gillathletics.com
800-637-3090

730181 - FUSION 4x8 STARTING BLOCK INSTRUCTIONS

Replacement Parts



- 7301811C02 - Royal Blue
- 7301811C03 - Red
- 7301811C05 - Orange
- 7301811C12 - Black
- 7301811C15 - Green

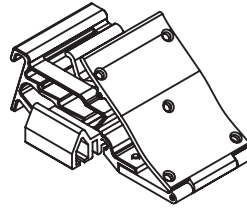

73018121
Left Pedal Assembly

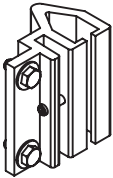

73016506
Pedal-Rail
Connector

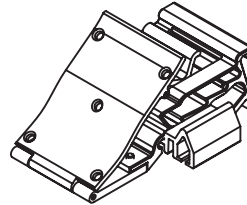

73018122
Right Pedal Assembly

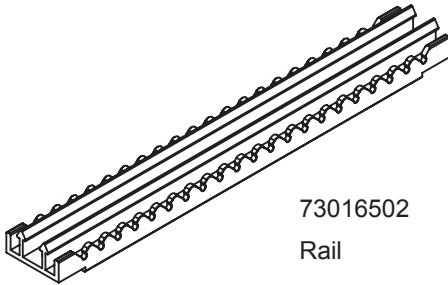

73016502
Rail



73016504
Spike Kit
includes 16 spikes

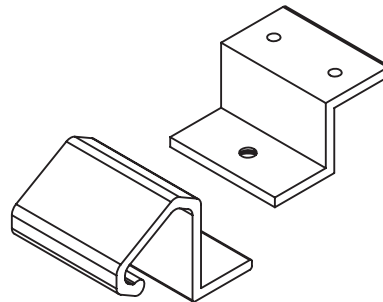

730175003
Handle & Bracket Kit
includes screws



www.gillathletics.com
800-637-3090

730181 - FUSION 4x8 STARTING BLOCK INSTRUCTIONS

Replacement Parts

PART #	DESCRIPTION	QTY	
1	M2829	M8 x 20 Flat Head Cap Screw	2
2	HDWE73018102	Pedal to Rail Set Screw	1
3	M2830	M6 Flat Washer	2
4	M2831	M6 x 16 Cap Screw	2
5	HDWE73018105	Pedal Plate Top Hinge Set Screw	2
6	M1269	M6 x 35 Set Screw	2

