

**INSTRUCTIONS FOR USE**  
**WATER COOLER**  
**LINDR**



**Miloš LINDR**

**Cooling and dispensing systems**

IČO: 162 82 001 • DIČ: CZ 711 015 30 39

Sadová 132, CZ 503 15 Nechanice, Czech Republic

Tel.: +420 495 447 239 • Fax: +420 495 425 085

E-mail: [info@lindr.cz](mailto:info@lindr.cz) • [www.lindr.cz](http://www.lindr.cz)

Purchase in North America from BREWHA Equipment Co Ltd.  
<http://brewhaequipment.com/products/water-beer-and-wort-chiller>

**Introduction :**

Thank you for a purchasing our professional product and we believe it will operate to your satisfaction.

**This manual applies for models:**

AS-40, AS-80, AS-110, AS-160, AS-200,  
CWP-100, CWP-200, CWP-300,  
CWP-200 mobile, CWP-300 mobile,

**General instructions and precautions****Safety instructions:**

Warning! Respect the basic safety instructions given by the manufacturer. Take care of your personal safety. Cooling equipment is designed for flow type cooling of beverages. The supplier shall not be liable for damages caused by improper use.

**DO NOT USE THE MACHINE FOR ANY OTHER PURPOSES THEN WHAT IT IS INTENDED FOR!****General safety rules**

The manufacturer is not liable for damages caused by actions that do not follow following these instructions.

**CAUTION:**

Before connecting the main electrical supply, check if the voltage and frequency corresponds to the specifications shown on the machine.

**CAUTION:**

Make sure the socket to connect the cooler is equipped with sufficient circuit breaker (16A depending on the type) according to CSN 33 1500 norm.

**CAUTION:**

Before any cleaning or maintenance, always disconnect the machine from the electricity supply: Put the main switch (thermostat) into the position "O" and pull out the plug.

**CAUTION:**

Never insert tools or other objects into the propeller fan.

**CAUTION:**

Never touch electrical components with wet or damp hands.

**CAUTION:**

To ensure the performance of the cooling unit, never block the air inlet.

**CAUTION:**

With the CWP-100 model, CWP-200, CWP-200 mobile, CWP-300 and CWP-300 mobile models, they should **NEVER BE** used if the door is opened. Otherwise, there would be a disruption of air circulation and the subsequent failure of the machine.

**CAUTION:**

All our equipment must be installed by appropriately trained staff.

More detailed maintenance such as cleaning and servicing the cooling system must be performed by authorized technicians who are familiar with cooling and electrical systems.

**CAUTION:**

If the supply cord is damaged, it must be replaced by the manufacturer, its service technicians or similarly qualified person in order to avoid dangerous situations.

**Installation and placement:**

After unpacking, place the cooler so that the heat generated by the cooling unit can be sufficiently ventilated. The cooler **MUST BE** placed on a horizontal surface.

**COOLER MUST NOT BE PLACED ON ITS SIDE EVEN DURING TRANSPORTATION.****Conditions of operation:**

Our cooling systems are designed to cool liquids with flow type cooling. These machines have all the features to ensure the health and safety of the user.

The machine should only be used in the premises of a normal conditions stated in CSN 33 2000-3 norm. It must not be placed near any heat source or direct sunlight. Cooling tank (No. 11) **MUST BE** filled with clean water and without any chemicals, right up to the overflow. The machine achieves optimal performance when used in ambient temperatures from 6°C to 28°C. For correct operation it is important to not cover any of the ventilation holes.

**DO NOT PLACE ANY OBJECTS ON THE COOLER THAT WOULD BLOCK AIR CIRCULATION.****THE MACHINE MUST NOT BE PLACED NEAR ANY HEAT SOURCE OR IN DIRECT SUNLIGHT.****Testing:**

The product is supplied so that it is ready to use.

**Warranty:**

There is a 24 month warranty from the date of purchase on all our equipment and related components from our production. During this warranty period we commit ourselves to replace any part free of charge, which will be covered under the warranty once recognized by the service center as faulty.

Manufacturer agrees to correct any errors or defects that occur when the cooling equipment is used properly according to the instructions provided in the instructions. The products used **for commercial purposes** are warranted for **12 months** from date of purchase, unless otherwise agreed by special agreement.

Materials replaced under warranty are our property and must be returned to by the customer.

**Equipment Description:**

1. recirculation pump
2. inlet of the beverage
3. outlet of the cooled beverage
4. fan
5. suction propeller
6. fan cover
7. condenser
8. cover of the electro panel
9. evaporator
10. cooling coil
11. plastic tank
12. motor compressor

**Model series of AS:**

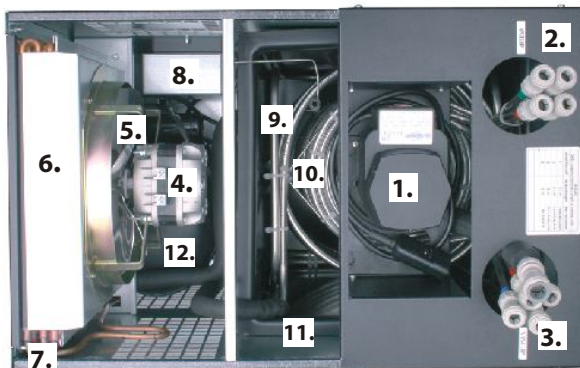

**Model series of CWP:**

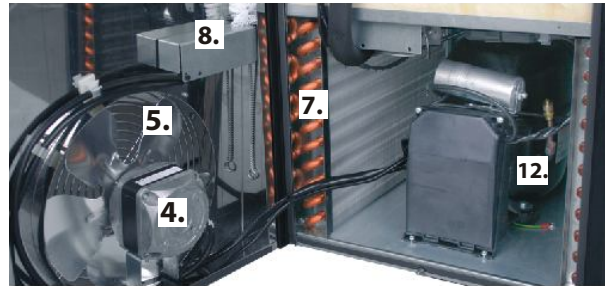
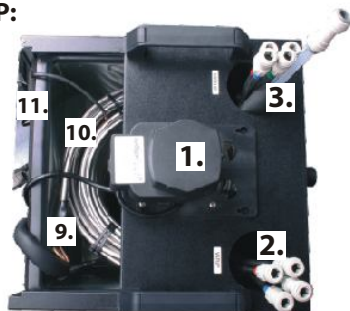

**Connection:**

1. Fill the Plastic tank (No. 11) with water right up to the overflow.

**CAUTION:**

After connecting the cooling coil the water level may drop in the plastic tank, so check again and **add water if necessary.**



2. Connect the cooling machine with dispense tower (output) and dispense heads (input). See page 13 and 14.



**Note:**

For the connection of tubes for the beverage use only fittings and clips specified by the supplier. Use a calibrated tube 6.7x9.5 mm.

**AFTER THE CONNECTION CHECK IF ALL THE JOINTS ARE PROPERLY SEALED.**

### Placement of the thermostat:

3. Model AS has a mechanical thermostat located on the front of the cooler. See picture

thermostat →



4. Model CWP See picture

thermostat →



### Temperature and setting:

5. The temperature of cooled beverages is controlled by the mechanical thermostat between 4°C and 10°C, which monitors the temperature of water bath (position 1-5), or the ice bank creation (4-45 kg depending on the type of product) (position 6-7).



0= off



No. 1 = maximum  
beverage temperature  
10°C



No.7 = minimum  
beverages temperature  
4°C

Once the following steps have been taken, you can start up the cooling unit by connecting the power cord and switching on the main switch.

### How to work with the fittings:

7. Push the tube into the fitting firmly (about 1.5 cm). The tube must be cut straight to avoid any imperfect connections. If you can't insert the tube in, you need to moisten the end.

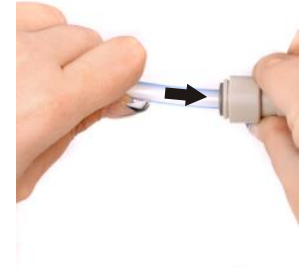

### Disconnection:

8. Hold the gray ring towards the body of the fitting and pull out the tube.

### CAUTION:

If you don't hold the grey ring while pulling the tube, the fitting will cut even more into the tube.



grey ring

**THE TUBE MUST NOT BE UNDER PRESSURE WHEN DISCONNECTING !**

### Regular and the scheduled maintenance services:

Regarding routine maintenance, the information contained in this manual is intended for a regular operating staff, which must be properly trained. Regarding any emergency or scheduled maintenance, the contained information is intended for professional staff only.

### The basic safety instructions:

Before any work on the machine, it must be disconnected from the main electrical supply.

### Cleaning of the machine:

Before any cleaning of the machine, it must be disconnected from the main electrical supply. Cleaning of the condenser (No.7) must be performed only by a qualified person at least 1x per month by sweeping or by CO2 pressure. Perform the cleaning (sanitizing) of a stainless steel coil (No. 10) professionally with the use of for example DOPILINE or TM Desana solution, and always after a minimum of fourteen days.

### Cleaning of the condenser:

9. By pulling upwards you will remove the fan cover (No.7) from metal slides.



7.



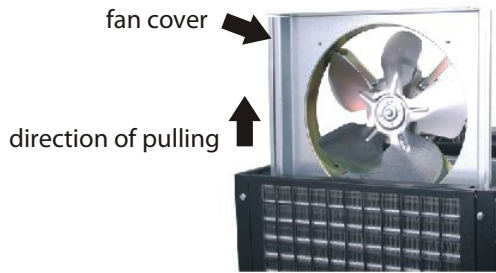

10. Cover (No. 7) Take off the fan.

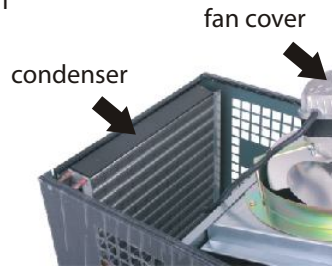

11. Unscrew the fastening screws from the cooler on the side where the condenser is placed. (picture 3.1 and 3.2.)



12. First, pull out the loosen cover about 3 cm in a upward direction (picture 4.1.), then pull to the side (pic. 4.2). Loosen the other side of the cover so you can pull out the whole cover from the metal slides.

4.2. direction of pulling →



13. Now you can clean the condenser by brushing or by the air pressure from both sides.



**Periodic checks**

- check, if the power supply plug is firmly plugged into the socket.
  - check that the machine is not exposed to radiant heat
  - check the level and cleanliness of the water bath in the plastic container (No.11) (after six months of operation we recommend to replace the water bath)
  - the condenser of the cooling unit should be cleaned regularly
  - sanitizing
- When sanitizing **do not forget** to also sanitize the dispensing tap and the dispense head. You need to disassemble them, then soak in a chemical solution and clean thoroughly to remove any residue left by the beer.

**Special maintenance:**

This chapter provides information for a qualified persons only.

- check the correct functioning of the circuit breaker and a status of power cord.
- check whether there is a noticeable change in a machine operation.

If you need to order replacement parts, it is always necessary to state the type and serial number of the machine. This is written on the label.

**Electrical connection:**

The machine should be connected to the power supply 220-240V 50Hz, 16A fuse. Plug circuit wiring must comply with applicable regulations of IEC, EN and ISO standards. If the power cord (cable) is damaged, it must be replaced by the manufacturer, its service agent or similarly qualified person in order to avoid dangerous situations.

**Potential areas of risk, risks which cannot be removed.**

**Risks related to the electricity:**

Potential risks are removed thanks to the construction of the electrical system according to CSN 331500, EN, and ISO norms.

**Note:**

Electrical machine must be checked within scheduled dates according to CSN norm by the authorized person. Service, spare parts, required inspections and check ups are carried out and provided by the Lindr company.

### Connection A: AS - 40 (coil 2x) pressurizing CO2/ N2

1. Beverage inlet
2. Beverage outlet (the beverage runs through the python tubing No.11 illustration)
3. Dispense head (S-type, A-type, M-type)
4. Plastic fitting **F 5/8 x9.5mm**
5. Plastic fitting **F 5/8 x 8 mm**
6. Plastic fitting splitter **8 x 8 x 8mm**
7. Pressure reducer 1-way N2/ CO2
8. Beverage
9. Plastic fitting **JG SS 9.5 x8mm**
10. Plastic fitting **JG straight 12.7 x8mm**

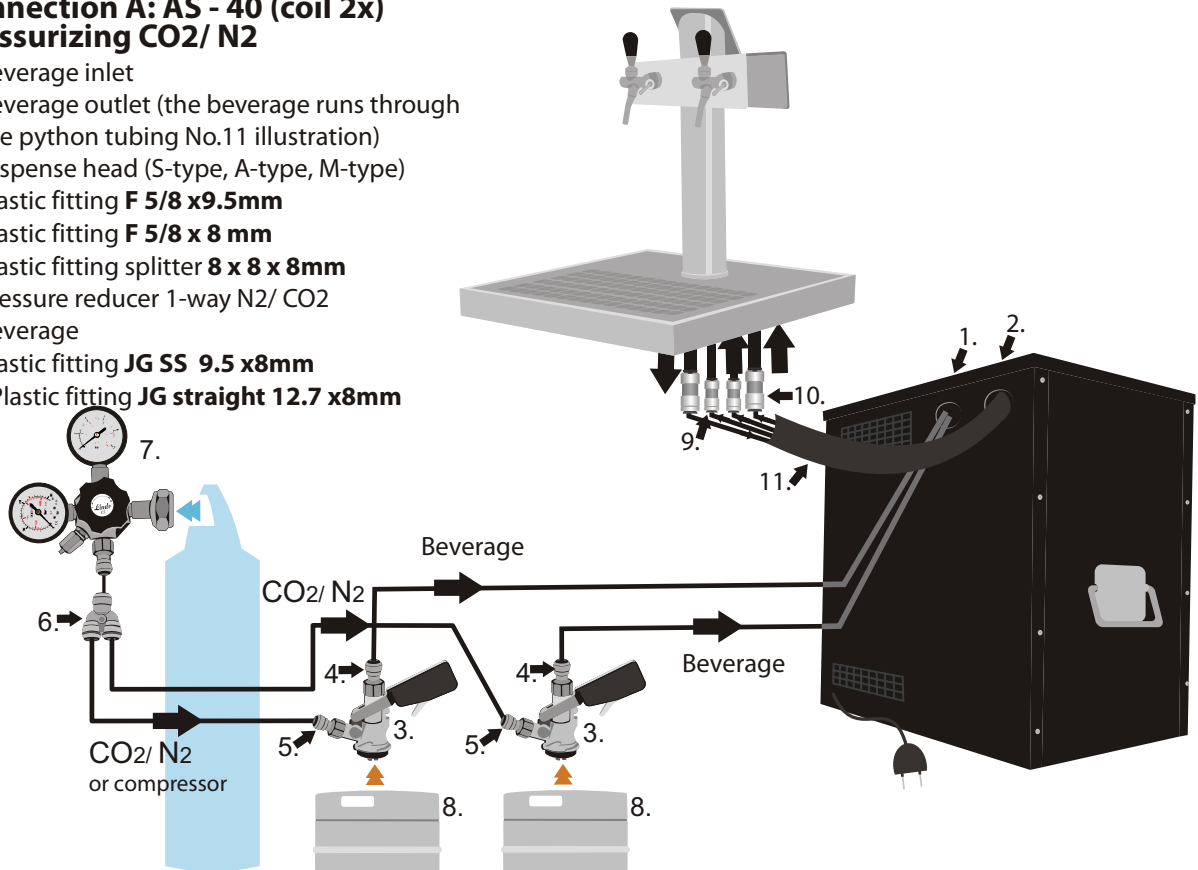

### Connection with dispense tower B: AS - 80 (coil 2x)

1. Beverage inlet
2. Beverage outlet (the beverage runs through the python tubing 2+2 No.12 illustration)
3. Tray for the clarifier
4. Dispense head (S-type, A-type, M-type)
5. Plastic fitting **F 5/8 x9.5mm**
6. Plastic fitting **F 5/8 x 8 mm**
7. Plastic fitting splitter **8 x 8 x 8mm**
8. Pressure reducer 1-way N2/ CO2
9. Beverage
10. Plastic fitting **JG SS 9.5 x8mm (2x)**
11. Rychlospojka **JG straight 12.7 x8mm (2x)**

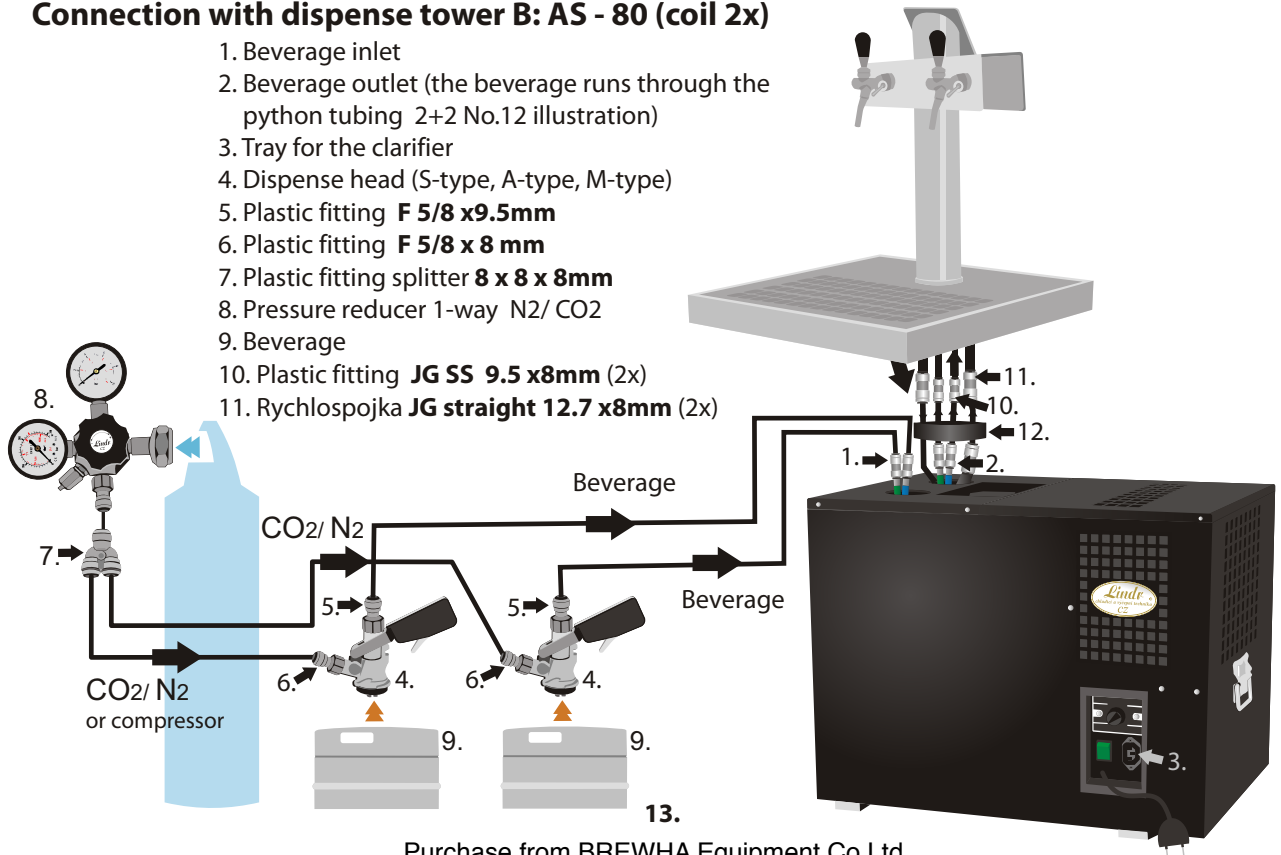

## Connection with dispense tower C: CWP - 200 (coil 4x) pressurizing CO<sub>2</sub>/ N<sub>2</sub>

1. Beverage inlet
2. Beverage outlet (the beverage runs through the python tubing 4+2 No.12 illustration)
3. Thermostat
4. Dispense head (S-type, A-type, M-type)
5. Plastic fitting **F 5/8 x9.5mm**
6. Plastic fitting **F 5/8 x 8 mm**
7. Plastic fitting splitter **8 x 8 x 8mm** (3x)
8. Pressure reducer 1-way N<sub>2</sub>/ CO<sub>2</sub> N<sub>2</sub>/ CO<sub>2</sub>
9. Beverage
10. Plastic fitting **JG SS 9.5 x8mm** (4x)
11. Plastic fitting **JG straight 12.7 x8mm** (2x)

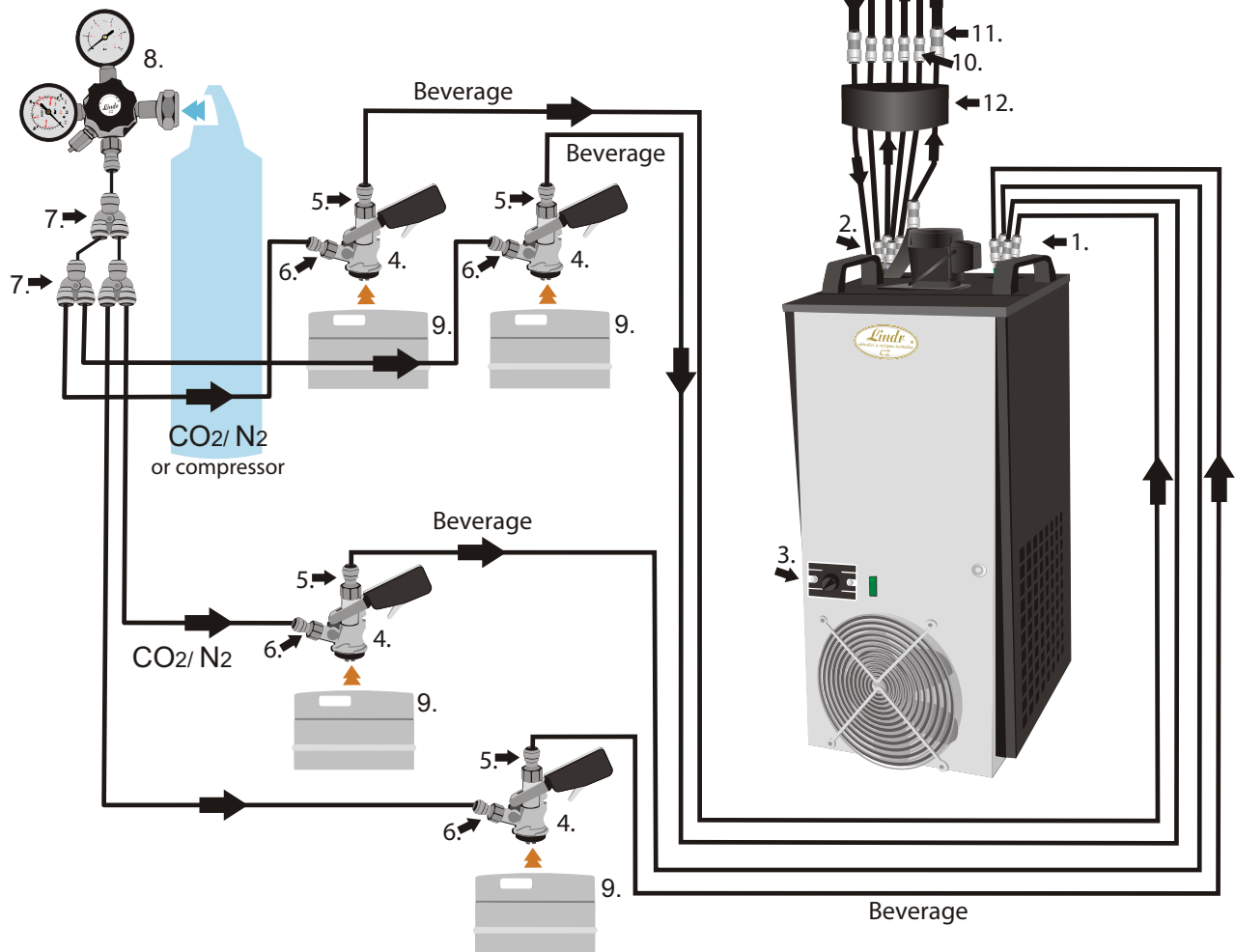

14.

**Before calling service:**

Problem	Cause	How to fix it
The machine is too noisy	There is a fallen object in the machine.	Remove the object that is not in contact with the cooling machine.
	There is a fallen object in the area of the fan.	Remove the object from the fan area.
The machine does not work:	The power cable is not connected.	Connect the power cord into the socket.
	Socket does not work.	
	The main switch is not turned on or the thermostat is set to „0“.	Turn on the power switch and set the thermostat to the desired value.
The machine is turned on, but does not cool:	Ventilation holes are covered.	Remove anything from the vent holes.
	The machine has a dirty condenser.	Remove the coarse dirt and wipe off the dust.
Fittings do not seal properly	The tube is not inserted correctly.	Pull out the tube, check for any sharp edges, and if there are, cut with knife.
	damage to the tube	Pull out the tube and shorten 2cm.

If, after the above recommended checks the fault still persists, please contact customer service.

**Do not forget to specify the following:**

- type of defect
- type of product
- product serial number (listed on the label)

**Ordering parts:****ALWAYS USE ORIGINAL PARTS.**

The manufacturer or supplier does not take any responsibility for parts which are not original or recommended by the manufacturer.

**Technical specifications:**

The technical label is located on the external front side (under the control panel) of the machine or on the inside divider. The CWP -100, CWP-200, CWP 300, CWP -200 mobile and CWP-300 mobile have the label on the outside shell on the front of the machine.