

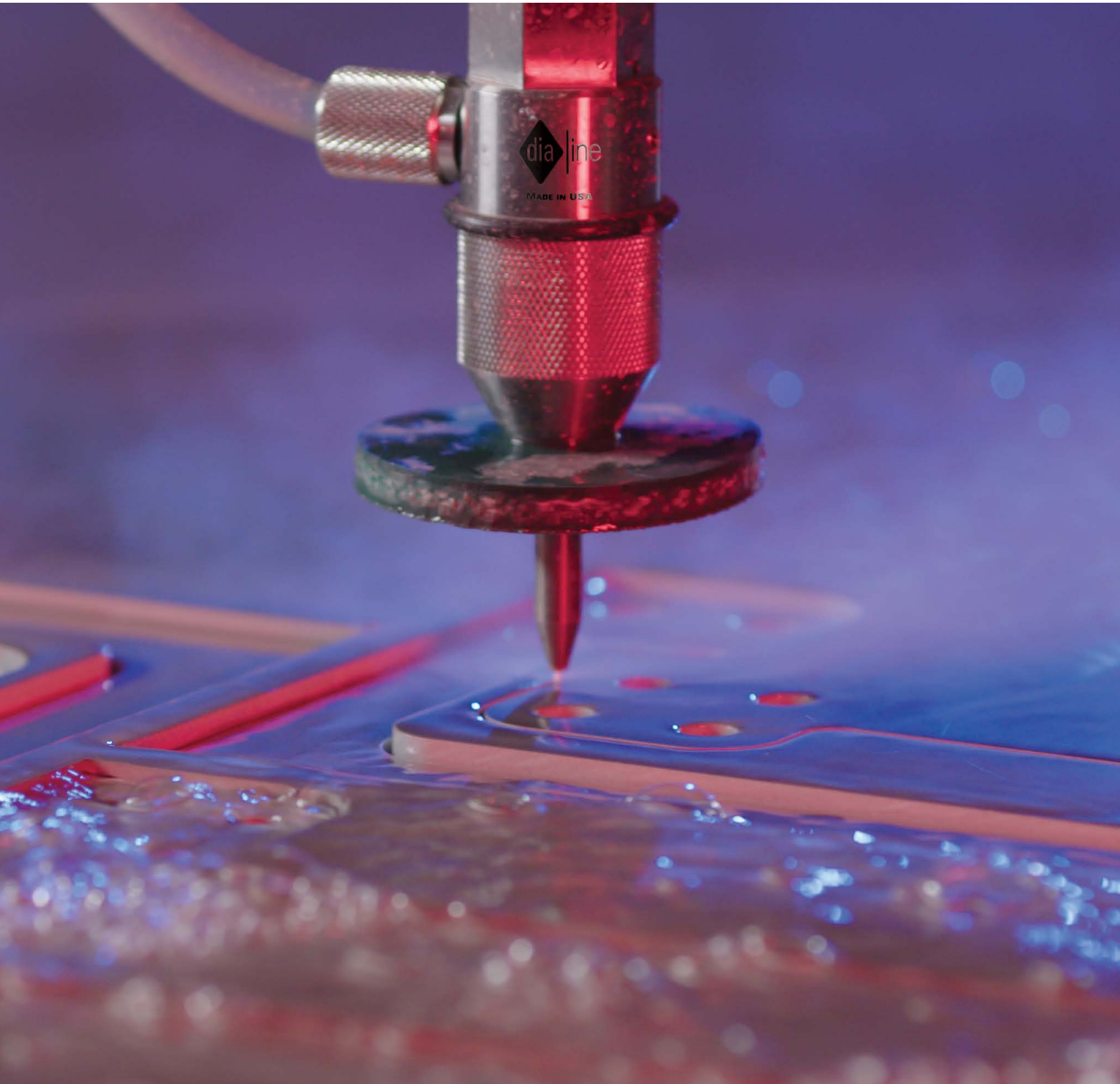

2021 waterjet parts price book

Premium waterjet parts for every brand

Replacement parts suitable for high-pressure components



We have worked a lifetime on your shop floor

AccuStream has been in the waterjet business from the beginning. Our founder is an industry pioneer, leading research and development on the first generations of high-pressure intensifier pumps. Early on, he opened a waterjet job shop – the shop that would be the genesis of AccuStream.

Born and raised as a waterjet job shop, we proved ourselves by overcoming the same challenges you confront every day: staying competitive in the market, keeping machines running, finding affordable replacement parts and technical service and quickly making repairs to get back into production. In our search for the best ways to be competitive and conquer other keep-you-up-at-night dilemmas, we found a recurring truth – we were uniquely positioned to develop replacement parts for waterjets. And not just any replacement parts, but parts that met our own high standards for component life, quality, availability and price. This is the idea that launched AccuStream and our products for all waterjets.

We felt from the beginning that providing long-lasting, high quality parts was not enough. As a waterjet user, you need a partner who you can depend on to pick up the phone when you call, answer your waterjet questions, help with your day-to-day waterjet dilemmas and deliver parts with the sense of urgency demanded by your business. A partner who can get you what you need when you need it. How do we know? We've been there.

As a brand of Hypertherm, we're taking that care to a whole new level. We are 100% Associate-owners of Hypertherm, which means that each of us has a vested interest in your satisfaction and a strong drive to provide the best products and services. Let us earn your business with replacement parts engineered and manufactured in America. Parts that can lower your cost of ownership by delivering more cuts, more work hours, increased productivity and ultimately greater profitability. Parts delivered with a level of service that you will only find with AccuStream.



Table of contents

AccuStream parts

Orifices

DiaLine orifices	4
A2 orifices	4
Thimble filters	4

Nozzles

DiaLine nozzles	5
A2 nozzles	6

Cutting heads

DiaLine cutting heads	8
DiaLine adapters	9
AccuValve adapters	9
Water-only conversion parts	9

Cutting heads

DiaLine4 cutting head	12
DiaLine4 parts	12
DiaLine4 orifices	12

On/off valves

DiaLine on/off valves	14
DiaLine on/off valve mounting hardware	15
AccuLine water-only on/off valves	15

Waterjet products

Waterjet bricks	17
Hypertherm abrasive regulators	17
Hypertherm abrasive pots	18
Hypertherm reverse osmosis systems	18

Replacement parts for high-pressure components

High-pressure tubing

60k tubing	21
OMAX®-specific high-pressure tubing	22
100k tubing	22
Protective sheathing	22

60K fittings

Swivel repair kits	23
Swivels	24
Straight couplings	25
Straight reducer couplings	25
Collars	25
Glands	25
Plugs	26
Adapters	26
Crosses	26
Tees	26
Elbows	27
Two-way straight valves	27
Two-way angle valves	27
Three-way angle valves	27
Inline wyes	27
Antivibration assemblies	28

100K fittings

Swivels	28
Antivibration assemblies	28

Nipples

1/4 inch	29
3/8 inch	29
9/16 inch	29

Hardware

Tube clamp pairs	30
Inline filters	30

Tools

Coning and threading tools	31
Other tools	33

Lubricants

Lubricants	34
------------------	----

Gauges

Gauges	34
--------------	----

AccuStream parts



AccuStream parts

Orifices

DialLine orifices

AccuStream #	Description	Price	
1-12835-XXX	Ruby Orifice Use for water and abrasive applications.	\$18.50	
1-12749-XXX	Diamond Orifice Use for water and abrasive applications.	\$425.00	
1-22835-XXX	Ultra Sapphire Orifice	\$22.50	

A2 orifices

AccuStream #	Description	Price	
1-11007-XXX	Ruby Orifice Use for water and abrasive applications.	\$15.00	
1-11007DA-XXX	Diamond Orifice, Abrasive	\$450.00	
1-11007D-XXX	Diamond Orifice, Water-only	\$425.00	
1-21007-XXX	Ultra Sapphire Orifice	\$18.00	

-XXX indicates the availability of multiple sizes. Call us or visit AccuStream.com for details.

Thimble filters

AccuStream #	Description	Price	
1-14279	Thimble Filter Assembly, 1/4-in. Female to 1/4-in. Male	\$175.00	
1-14281	Thimble Filter Bullet, 1/4 in. Use with 1-14279 Thimble Filter Assembly.	\$41.00	
1-13553	Thimble Filter Assembly, 1/4-in. Female to 3/8-in. Male	\$175.00	
1-11394	Adapter, 1/4-in. Female to 3/8-in. Male	\$70.00	
1-12533	Thimble Filter Element and Bullet Use with 1-13553 Thimble Filter Assembly.	\$136.00	
1-11288	Thimble Filter Coned Bullet Insert, 3/8 in. Use with 1-13553 Thimble Filter Assembly.	\$11.50	
1-13174	Thimble Filter Assembly, 3/8-in. Female to 3/8-in. Male	\$175.00	
1-12401	Thimble Filter Element	\$124.00	

Nozzles

DiaLine nozzles

.281 ROCTEC® 100 nozzles

AccuStream #	Description	Price
1-12779-020-20	.281 Nozzle, .020 in. × 2.00 in.	\$75.00
1-12779-020-30	.281 Nozzle, .020 in. × 3.00 in.	\$75.00
1-12779-020-40	.281 Nozzle, .020 in. × 4.00 in.	\$85.00
1-12779-030-30	.281 Nozzle, .030 in. × 3.00 in.	\$75.00
1-12779-030-35	.281 Nozzle, .030 in. × 3.50 in.	\$85.00
1-12779-030-40	.281 Nozzle, .030 in. × 4.00 in.	\$85.00
1-12779-035-30	.281 Nozzle, .035 in. × 3.00 in.	\$75.00
1-12779-035-40	.281 Nozzle, .035 in. × 4.00 in.	\$85.00
1-12779-040-20	.281 Nozzle, .040 in. × 2.00 in.	\$75.00
1-12779-040-30	.281 Nozzle, .040 in. × 3.00 in.	\$75.00
1-12779-040-35	.281 Nozzle, .040 in. × 3.50 in.	\$85.00
1-12779-040-40	.281 Nozzle, .040 in. × 4.00 in.	\$85.00
1-12779-045-30	.281 Nozzle, .045 in. × 3.00 in.	\$75.00
1-12779-050-30	.281 Nozzle, .050 in. × 3.00 in.	\$75.00
1-12779-050-35	.281 Nozzle, .050 in. × 3.50 in.	\$85.00

.281 ROCTEC® 500 nozzles

AccuStream #	Description	Price
1-11277-020-20	.281 Nozzle, .020 in. × 2.00 in.	\$180.00
1-11277-030-30	.281 Nozzle, .030 in. × 3.00 in.	\$180.00
1-11277-030-40	.281 Nozzle, .030 in. × 4.00 in.	\$200.00
1-11277-035-30	.281 Nozzle, .035 in. × 3.00 in.	\$180.00
1-11277-035-40	.281 Nozzle, .035 in. × 4.00 in.	\$200.00
1-11277-040-30	.281 Nozzle, .040 in. × 3.00 in.	\$180.00
1-11277-040-40	.281 Nozzle, .040 in. × 4.00 in.	\$200.00
1-11277-045-30	.281 Nozzle, .045 in. × 3.00 in.	\$180.00
1-11277-050-30	.281 Nozzle, .050 in. × 3.00 in.	\$180.00
1-11277-050-40	.281 Nozzle, .050 in. × 4.00 in.	\$200.00
1-11277-050-50	.281 Nozzle, .050 in. × 5.00 in.	\$334.00

AccuStream parts

Nozzles

A2 nozzles





.300 ROCTEC® 100 nozzles

AccuStream #	Description	Price	
1-12781-020-30	.300 Nozzle, .020 in. × 3.00 in.	\$75.00	
1-12781-030-30	.300 Nozzle, .030 in. × 3.00 in.	\$75.00	
1-12781-030-40	.300 Nozzle, .030 in. × 4.00 in.	\$85.00	
1-12781-035-30	.300 Nozzle, .035 in. × 3.00 in.	\$75.00	
1-12781-040-30	.300 Nozzle, .040 in. × 3.00 in.	\$75.00	
1-12781-040-40	.300 Nozzle, .040 in. × 4.00 in.	\$85.00	
1-12781-045-30	.300 Nozzle, .045 in. × 3.00 in.	\$75.00	

.300 ROCTEC® 500 nozzles

AccuStream #	Description	Price	
1-13189-020-20	.300 Nozzle, .020 in. × 2.00 in.	\$175.00	
1-13189-030-30	.300 Nozzle, .030 in. × 3.00 in.	\$175.00	
1-13189-040-30	.300 Nozzle, .040 in. × 3.00 in.	\$175.00	

Replacement parts

AccuStream #	Description	Price	
1-12276	Collet, .300 in.	\$6.90	
1-12762	Inlet Tube	\$41.00	
1-11362	Nozzle Splash Guard, Carbide	\$70.00	
1-11361	Nozzle Splash Guard, Rubber	\$5.00	

DiaLine™ from AccuStream

The industry's FIRST customizable cutting head

600 hours – that's the longest diamond warranty in the industry and it's only available with the DiaLine Cutting Head from AccuStream. The DiaLine Cutting Head not only lasts longer, it cuts more accurately and is the most customizable cutting head available. The DiaLine from AccuStream isn't just another cutting head. It's the best cutting head.









AccuStream parts







Cutting heads

DiaLine cutting heads

Single-inlet assemblies

AccuStream #	Description	Price	
1-13904-2-1-1	.281 DiaLine Cutting Head Assembly Single 3/8-in. inlet, includes standard nozzle nut	\$416.00	
1-13904-2-1-2	.281 DiaLine Cutting Head Assembly Single 3/8-in. inlet, includes 3-in. clamping nut, nozzle splash guard	\$530.00	
1-13904-2-1-3	.281 DiaLine Cutting Head Assembly Single 3/8-in. inlet, includes 4-in. clamping nut, nozzle splash guard	\$560.00	
1-13904-2-2-1	.281 DiaLine Cutting Head Assembly Single 3/16-in. inlet, includes standard nozzle nut	\$416.00	
1-13904-2-2-2	.281 DiaLine Cutting Head Assembly Single 3/16-in. inlet, includes 3-in. clamping nut, nozzle splash guard	\$530.00	
1-13904-2-2-3	.281 DiaLine Cutting Head Assembly Single 3/16-in. inlet, includes 4-in. clamping nut, nozzle splash guard	\$560.00	

Dual-inlet assemblies

AccuStream #	Description	Price	
1-13904-3-1-1	.281 DiaLine Cutting Head Assembly Dual 3/8-in. inlets, includes standard nut	\$530.00	
1-13904-3-1-2	.281 DiaLine Cutting Head Assembly Dual 3/8-in. inlets, includes 3-in. clamping nut, nozzle splash guard	\$635.00	
1-13904-3-1-3	.281 DiaLine Cutting Head Assembly Dual 3/8-in. inlets, includes 4-in. clamping nut, nozzle splash guard	\$670.00	
1-13904-3-2-1	.281 DiaLine Cutting Head Assembly Dual 3/16-in. inlets, includes standard nut	\$530.00	
1-13904-3-2-2	.281 DiaLine Cutting Head Assembly Dual 3/16-in. inlets, includes 3-in. clamping nut, nozzle splash guard	\$635.00	
1-13904-3-2-3	.281 DiaLine Cutting Head Assembly Dual 3/16-in. inlets, includes 4-in. clamping nut, nozzle splash guard	\$670.00	

Cutting heads



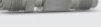

DiaLine adapters

AccuStream #	Description	Price	
1-11358-4	Adapter, DiaLine to Flow® Short nozzle body, 4.330 in.	\$238.00	
1-11755	Adapter, DiaLine to KMT®	\$190.00	
1-12672	Adapter, Integrated, DiaLine to OMAX®	\$206.00	
1-13920	Adapter, Nonintegrated, DiaLine to OMAX®	\$220.00	
1-13721	Swivel Adapter, DiaLine to OMAX® (Tilt-A-Jet®)	\$249.00	
1-11009	Adapter, A2 to Jet Edge™, 3.5-in. Use with 1-11010 valve seat.	\$200.00	
1-11756	Swivel Adapter, DiaLine to Jet Edge™	\$172.00	
1-13841	Swivel Adapter, DiaLine to Jet Edge™, 7.50 in. Use with 1-11010 valve seat.	\$193.00	

AccuValve adapters

AccuStream #	Description	Price	
1-13730	Swivel Adapter, 2.315 in. Use with DiaLine cutting head assemblies.	\$182.00	
1-13841	Swivel Adapter, 3.395 in. Use with DiaLine cutting head assemblies.	\$193.00	
1-13839	Swivel Adapter, 4.985 in. Use with DiaLine cutting head assemblies.	\$234.00	

Water-only conversion parts















AccuStream #	Description	Price	
1-14321	Water-only Conversion Kit Use with 1-12835-XXX or 1-12749-XXX DiaLine Orifices. Includes adapter, seat, retainer nut	\$255.00	
1-14233	Adapter, Water-only	\$182.00	
1-14232	Seat, Water-only	\$29.25	
1-11299	Nozzle Retainer Nut	\$61.50	

AccuStream parts

Cutting heads

DialLine cutting heads

Replacement parts

AccuStream #	Description	Price	
1-12747	Mixing Chamber Use with single-inlet cutting head assemblies.	\$162.00	
1-13556	Mixing Chamber Use with dual-inlet cutting head assemblies.	\$162.00	
1-13879	Abrasive Body Assembly Use with single-inlet cutting head assemblies. Includes mixing chamber, retainer collet, O-rings	\$349.00	
1-13901	Abrasive Body Assembly Use with dual-inlet cutting head assemblies. Includes mixing chamber, retainer collet, O-rings	\$401.00	
1-12752	Abrasive Inlet Connector, 3/8 in. Use with single-inlet and dual-inlet cutting head assemblies.	\$25.00	
1-13820	Abrasive Inlet Connector, 3/16 in. Use with single-inlet and dual-inlet cutting head assemblies.	\$28.00	
1-11679-012	Inlet O-ring	\$1.05	
1-11357	Retainer Collet	\$6.90	
1-12836	Set Screw	\$1.60	
1-11679-216	O-ring, -216	\$1.05	
1-13632	Clamping Nut, 3 in. Accepts 1-13727 Nozzle Splash Guard	\$123.00	
1-13848	Clamping Nut, 4-in. Accepts 1-13727 Nozzle Splash Guard	\$161.00	
1-12751	Nozzle Nut, Standard Does not accept 1-13727 Nozzle Splash Guard	\$56.50	
1-13727	Nozzle Splash Guard Use with 1-13198 Clamping Nut.	\$33.50	
1-13198	Clamping Nut	\$40.50	

Looking for orifices? See page 6. Looking for nozzles? See page 7. Looking for on/off valve repair kits? See page 19.

DiaLine4™ from AccuStream

Direct replacement for the Flow Paser 4

The new DiaLine4 is built with the same rigorous engineering used in our DiaLine cutting heads today. The DiaLine4's patent-pending cutting head technology is engineered to be a direct replacement for the Flow Paser 4 cutting head, requiring no additional configuring.











AccuStream parts

Cutting heads

DiaLine4 cutting head

AccuStream #	Description	Replaces	Price	
1-18741	DiaLine4 complete assembly	1-14525	\$700.00	

DiaLine4 parts

AccuStream #	Description	Replaces	Price	
1-11357	Collet		\$6.90	
1-11679-212	O-ring, -212		\$1.05	
1-12747	Mixing chamber		\$162.00	
1-12752	Abrasive Inlet Connector, 3/8 in.		\$25.00	
1-12836	Set screw		\$1.60	
1-14465	Blast disc	711933-1	\$5.70	
1-18717	Nozzle splash guard	711621-1 040411-1	\$15.00	
1-18718	Abrasive body	041138-1	\$350.00	
1-18719	Nozzle nut		\$124.00	

DiaLine4 orifices

AccuStream #	Description	Price	
1-12749-XXX	Diamond orifice	\$425.00	
1-22835-XXX	Ultra sapphire orifice	\$22.50	
1-12835-XXX	Ruby orifice	\$18.50	

-XXX indicates the availability of multiple sizes. Call us or visit AccuStream.com for details.

AccuValve on/off valve

Rated for pressures up to 65K



The AccuValve is designed for flexible production in either pure water or abrasive waterjet cutting applications. Lightweight with a compact design, the AccuValve can be mounted on any motion system and provides responsive on/off control for pressures up to 65K. With long-life components and easy maintenance, the AccuValve ensures maximum uptime.



AccuStream parts

On/off valves



DialLine on/off valves

AccuStream #	Description	Price	
1-13903-1-1-1	On/off Valve, Top-inlet, 6.375 in. (A-dimension) Includes 6.375-in. swivel adapter	\$990.00	
1-13903-1-1-2	On/off Valve, Top-inlet, 7.50 in. (A-dimension) Includes 7.50-in. swivel adapter	\$1,010.00	
1-13903-1-1-3	On/off Valve, Top-inlet, 9.075 in. (A-dimension) Includes 9.075-in. swivel adapter	\$1,040.00	
1-13903-1-2-1	On/off Valve, Top-inlet, High-performance, 6.375 in. (A-dimension) Includes 6.375-in. swivel adapter	\$1,070.00	
1-13903-1-2-2	On/off Valve, Top-inlet, High-performance, 7.50 in. (A-dimension) Includes 7.50-in. swivel adapter	\$1,090.00	
1-13903-1-2-3	On/off Valve, Top-inlet, High-performance, 9.075 in. (A-dimension) Includes 9.075-in. swivel adapter	\$1,120.00	
1-13903-2-1-1	On/off Valve, Side-inlet, 6.375 in. (A-dimension) Includes 6.375-in. swivel adapter	\$990.00	
1-13903-2-1-2	On/off Valve, Side-inlet, 7.50 in. (A-dimension) Includes 7.50-in. swivel adapter	\$1,010.00	
1-13903-2-1-3	On/off Valve, Side-inlet, 9.075 in. (A-dimension) Includes 9.075-in. swivel adapter	\$1,040.00	
1-13903-2-2-1	On/off Valve, Side-inlet, High-performance, 6.375 in. (A-dimension) Includes short swivel adapter	\$1,070.00	
1-13903-2-2-2	On/off Valve, Side-inlet, High-performance, 7.50 in. (A-dimension) Includes 7.50-in. swivel adapter	\$1,090.00	
1-13903-2-2-3	On/off Valve, Side-inlet, High-performance, 9.075 in. (A-dimension) Includes 9.075-in. swivel adapter	\$1,120.00	







Looking for swivels? See page 78.

On/off valves

DiaLine on/off valve mounting hardware

AccuStream #	Description	Price	
1-11198	AccuValve Front-mounting Collar, Standard	\$203.00	
1-13878	AccuValve Back-mounting Collar	\$203.00	
1-14142	Valve Body Mounting Plate, High-performance	\$115.00	

AccuLine water-only on/off valves



AccuStream #	Description	Price	
1-13903-1-1-4	AccuLine On/off Valve, Top-inlet	\$1,060.00	
1-13903-1-2-4	AccuLine On/off Valve, Top-inlet, High-performance Use for high-cycle applications	\$1,150.00	
1-13903-2-1-4	AccuLine On/off Valve, Side-inlet	\$1,060.00	
1-13903-2-2-4	AccuLine On/off Valve, Side-inlet, High-performance Use for high-cycle applications	\$1,150.00	
1-12881	Adapter, Water-only Use with AccuLine On/off Valves	\$193.00	
1-12849	Water-only Nut Use with 1-12881 Water-only Adapter	\$73.00	

AccuLine assemblies are for water-only cutting heads. Use with 1-11007D-XXX Water-only Diamond Orifice or 1-11007-XXX Ruby Orifice. Looking for orifices? See page 6.



AccuStream parts

On/off valves







Repair kits

AccuStream #	Description	Price	
1-12686	AccuValve Actuator Repair Kit Includes exhaust muffler, springs, fitting, snap rings, O-rings	\$84.00	
1-11328	On/off Valve and Bleed-down Valve Repair Kit Includes 1-11010 AccuSeat, needle, needle bearing, valve seal	\$94.00	
1-13683	High-cycle On/off Valve Repair Kit Includes 1-11010 AccuSeat, needle, needle guide, valve seal	\$151.00	

Assemblies

AccuStream #	Description	Price	
1-12828	AccuValve Assembly, Top-inlet	\$515.00	
1-13732	AccuValve Assembly, Side-inlet	\$515.00	

Replacement parts

AccuStream #	Description	Price	
1-11033	AccuValve Valve Body	\$260.00	
1-14141	AccuValve Valve Body, High-performance	\$286.00	
1-11010	AccuSeat	\$24.00	
1-11562	Needle	\$33.50	
1-13682	Straight Needle, High-cycle	\$108.00	
1-12178	Needle Bearing	\$33.50	
1-11043	Valve Seal	\$14.40	

Waterjet products

Waterjet bricks

AccuStream #	Description	< 48	Pallet of 48	Pallet of 96
1-11124B	Black Waterjet Bricks	\$33.00	\$30.00	\$28.00
1-11124W	White Waterjet Bricks			

Prices are per brick. Bricks are 4 in. × 6 in. × 48 in.

AccuStream #	Description	Price
1-11124B-6	Black Waterjet Bricks 6-pack	\$198.00
1-11124W-6	White Waterjet Bricks 6-pack	\$198.00

Waterjet cutting bricks are specially designed and manufactured to fully support parts during the waterjet cutting process. Made from a unique high-density polyethylene (HDPE), the bricks use a laminated flute pattern to minimize splashback from the jet while draining water and debris away quickly and effectively.

- Avoids part “frosting” from jet splashback
- Prevents small parts from falling into the catch tank
- Lightweight (11.4 lb per brick) and easy to handle
- Corrugation draws water and abrasive away from the cutting surface
- Corrosion free



Hypertherm abrasive regulators

Accustream #	Description	Price
1-13762	Hypertherm Abrasive Regulator II	\$1,220.00

Abrasive is the highest operating expense in abrasive waterjet cutting. Optimizing abrasive usage is key to enhancing the profitability of waterjet operations. The accuracy and versatility of the Hypertherm Abrasive Regulator II improve the cutting process and avoid waste by precisely delivering abrasive to the cutting head. With 30 settings that can be easily and quickly dialed in, the right amount of abrasive is consistently delivered to the cutting head.

Accustream #	Description	Price
1-13968	OMAX® Installation Kit Use with 1-13762 Hypertherm Abrasive Regulator II.	\$120.00

Everything needed to retrofit an OMAX® system with a Hypertherm Abrasive Regulator II is included in this installation kit.

- Tubing, 100 ft, 5/32-in. OD, .106-in. ID
- Clear polyurethane tubing, 6 ft, 3/16-in. OD, 1/8-in. ID
- 90° swivel, 1/8-in. male NPTF × 5/32-in. tube
- Straight coupling, 1/8-in. male NPTF × 5/32-in. tube
- Straight coupling, 1/2-in. male NPT × 3/8-in. tube
- Straight coupling, 1/4-in. male NPTF × 3/16-in. tube



AccuStream parts

Waterjet products

Hypertherm abrasive pots

Accustream #	Description	Price
1-11202	Hypertherm Abrasive Pot 800-pound capacity	\$4,500.00

Hypertherm's Abrasive Pot can increase the efficiency of waterjet operations by allowing easy access for refilling abrasive. The pot features a low level-indicator light to enable system operators to better plan for long cuts. A single valve pressurizes and depressurizes the pot. Use multiple pots to switch between abrasive types quickly.



Hypertherm reverse osmosis systems

AccuStream #	Description	Price
1-15084	Hypertherm Reverse Osmosis System 500 gallons per day flow rate	\$6,500.00
1-13899	Hypertherm Reverse Osmosis System 2,000 gallons per day flow rate	\$8,850.00

Water quality is critical to extending the life of high-pressure components. The Hypertherm Reverse Osmosis System delivers the right level of purified water directly to the pump to extend component life and lower operating costs. Hypertherm reverse osmosis (RO) systems come with a 300-gallon holding tank. A 500-gallon holding tank is also available. Contact an AccuStream sales representative for help identifying the best RO system for your equipment.



Replacement parts for high-pressure components



Replacement parts suitable for:

High-pressure components

Custom tubing

Hypertherm offers in-house coning, threading, bending and coiling of high-pressure tubing.

Custom tubing orders placed by 2:00 PM CST may be shipped the same day. Call to check availability.

AccuStream #	Tubing outer dimension (OD)	Cost per foot	Cost to cone and thread each end	Coiling available	Cost per bend
Custom	1/4 in.	\$21.00	\$16.00	yes	\$16.00
Custom	3/8 in.	\$25.00	\$16.00	no	\$16.00
Custom	9/16 in.	\$40.00	\$20.00	no	not available

Custom coils available in the following diameters: 2.500 • 6.00 • 7.500 • 8.750 • 9.500 • 10.000 • 10.750

Other custom coil diameters are available on request.

The diagrams below illustrate the measurements that are required to ensure a precise fit.

Diagram A shows a simple straight tube that is coned and threaded. Diagram B shows a custom tube with multiple bends.

Information required

- Outside diameter (OD)
- Length from tip to tip (A)

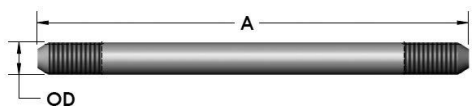

Diagram A

Information required

- Outside diameter (OD)
- Length from tip to outside edge (A)
- Length from outside edge to outside edge (B)
- Length from outside edge to tip (C)
- Radius (1 and 2)
- Minimum bend radius
 - 1/2 in. for 1/4-in. tubing
 - 1-1/2 in. for 3/8-in. tubing
- Minimum distance between bends
 - 3.50 in. for 1/4-in. tubing
 - 3.60 in. for 3/8-in. tubing

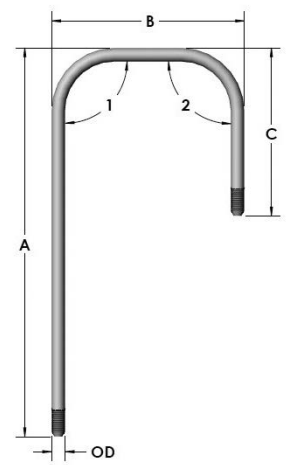

Diagram B

Provide all information to ensure an exact fit.

Shipping

- Tubing less than 8.5 feet long can be shipped by UPS or FedEx.
- 1/4-in. tubing more than 10 feet long can be coiled to ship by UPS or FedEx.
- 3/8-in. and 9/16-in. tubing that is more than 8.5 feet long must be shipped by LTL.

High-pressure tubing

60k tubing

1/4-inch outer diameter

AccuStream #	Description	Replaces	Price	
1-WJT46240AF	Tubing, 1/4 in. × 240 in. (20 ft)	A-0774-1 80074420	\$360.00	
1-WJT46288AF	Tubing, 1/4 in. × 288 in. (24 ft)	—	\$432.00	
1-WJT46360AF	Tubing, 1/4 in. × 360 in. (30 ft)	—	\$540.00	

Stock length, coned and threaded

3/8-inch outer diameter

AccuStream #	Description	Replaces	Price	
1-WJT66240AF	Tubing, 3/8 in. × 240 in. (20 ft)	A-0774-2 506478	\$440.00	

Stock length, coned and threaded

9/16-inch outer diameter

AccuStream #	Description	Replaces	Price	
1-WJT96240AF	Tubing, 9/16 in. × 240 in. (20 ft)	A-0774-3 5143474	\$650.00	

Stock length, coned and threaded







Replacement parts suitable for:

High-pressure components

High-pressure tubing

All AccuStream 60k tubing is autofrettaged to increase strength and durability.

OMAX®-specific high-pressure tubing

AccuStream #	Description	Replaces	Price	
1-13256	U-shape Tubing, Power Z-Axis	303245	\$101.00	
1-13280	Gooseneck Tubing, 40 in.	301909	\$142.00	
1-13437	Tubing Coil Use with 2652, 5555 and 55100.	303547	\$450.00	
1-14213	Tubing Coil Use with 2652, 5555 and 55100.	304613	\$450.00	
1-14214	Tubing Coil Use with 80160 and 80x.	303608	\$450.00	
1-14393	Nipple, 3.7 in. × 3 in.	301337-3	\$28.00	

100k tubing

AccuStream #	Description	Price	
1-WJT41 108AF	Tubing, 1/4 in. × 108 in. (9 ft)	\$270.00	
1-WJT61 108AF	Tubing, 3/8 in. × 108 in. (9 ft)	\$450.00	
1-WJT41 264AF	Tubing, 1/4 in. × 264 in. (22 ft)	\$660.00	
1-WJT61 264AF	Tubing, 3/8 in. × 264 in. (22 ft)	\$1,100.00	

Tubing is not coned or threaded.





Protective sheathing

AccuStream #	Description	Replaces	Price	
1-12579	Tubing Sheath, 1/4 in. Use with 60k or 100k 1/4-in. OD tubing.	A-2883	\$2.50	
1-12580	Tubing Sheath, 3/8 in. Use with 60k or 100k 3/8-in. OD tubing.	A-2884	\$3.50	



60K fittings

Swivel repair kits

Repair kits: 1/4 inch

AccuStream #	Description	Replaces	Price	
1-11360	Inline Minor Swivel Repair Kit, 1/4 in. Includes swivel seal, swivel hoop, swivel bearing	26183	\$44.50	
1-12864	90° Swivel Minor Repair Kit, 1/4 in. Use with 12863 90° Assembly. Includes swivel seal, swivel backup, terminal block, thrust bearing, swivel thrust washers, O-rings	—	\$94.00	
1-14592	90° Swivel Repair Kit, 1/4 in. Use with 13123 Dual-axis 90° Swivel Assembly. Includes seal assembly, backup swivel, thrust bearing shaft, thrust bearing washer, O-rings	B-5910-1	\$64.50	
1-13546	Parallel Swivel Repair Kit, 1/4 in. Use with 13338 Parallel Swivel Assembly. Includes backup ring, hoop, high-pressure seal, spacer	B-7447-1	\$85.00	

Repair kits: 3/8 inch

AccuStream #	Description	Replaces	Price	
1-12611	Inline and 90° Swivel Major Repair Kit, 3/8 in. Use with 12604 90° Assembly or 12605 Inline Assembly. Includes inline swivel seal, swivel bearing backup, thrust bearing, swivel shaft, metal-cased wiper, O-rings	—	\$240.00	
1-12610	Inline and 90° Swivel Minor Repair Kit, 3/8 in. Use with 12604 90° Assembly or 12605 Inline Assembly. Includes inline swivel seal, swivel bearing backup, thrust bearing, metal-cased wiper, O-rings	—	\$94.00	
1-11476	90° Swivel Repair Kit, 3/8 in. Includes seal, hoop, swivel bearing, thrust bearing, oil O-ring seal	007118-1	\$65.50	





Replacement parts suitable for:

High-pressure components



60K fittings

Swivels

Assemblies

AccuStream #	Description	Replaces	Price	
1-12607	Inline Swivel Assembly, 1/4-in. Female to male; use with 1-12609 Inline and 90° Swivel Major Repair Kit or 1-12608 Inline and 90° Swivel Minor Repair Kit. Includes swivel housings, bearing and bearing backup, swivel shaft, thrust bearing, swivel seal, antivibration assembly, O-rings	—	\$705.00	
1-12863	90° Swivel Assembly, 1/4-in. Female to female; use with 1-12864 90° Swivel Minor Repair Kit. Includes swivel seal, swivel backup, thrust bearing, O-ring	—	\$990.00	
1-13123	Dual-axis 90° Swivel Assembly, 1/4 in. Use with 1-14592 90° Swivel Repair Kit.	B-5725-1	\$1,240.00	
1-12605	Inline Swivel Assembly, 3/8-in. Female to male; use with 1-12611 Inline and 90° Swivel Major Repair Kit or 1-12610 Inline or 90° Swivel Minor Repair Kit. Includes swivel seal and housing, bearing backup, thrust bearing, swivel shaft, swivel bearing, bushing, O-rings	—	\$800.00	
1-12604	90° Swivel Assembly, 3/8-in. Female to male; use with 1-12611 Inline and 90° Swivel Major Repair Kit or 1-12610 Inline or 90° Swivel Minor Repair Kit. Includes swivel seal and housing, bearing backup, thrust bearing, swivel shaft, swivel bearing, bushing, O-rings	—	\$860.00	

Replacement parts

AccuStream #	Description	Replaces	Price	
1-13276	Bulkhead Swivel Seal Use with 304507 High-pressure Swivel Assembly.	201724	\$22.00	
1-13279	Swivel Seal Repair Kit Includes metal-cased wiper, bulkhead swivel seal, O-rings	301665	\$50.00	

60K fittings

Straight couplings

AccuStream #	Description	Replaces	Price	
1-13160-60-4	Straight Coupling, 1/4 in.	A-0780-1 A-0784-1 10079028 10078244	\$45.00	
1-13160-60-6	Straight Coupling, 3/8 in.	A-0780-2 A-0784-2 10078905 10079523 201678	\$60.00	
1-13160-60-9	Straight Coupling, 9/16 in.	10078772 A-0780-3 10078640	\$89.00	

All AccuStream couplings include standard collars and glands.

Straight reducer couplings

AccuStream #	Description	Replaces	Price	
1-13160-60-4F6F	Straight Reducer Coupling, 1/4-in. Female to 3/8-in. Female	A-1461 10079614	\$61.00	
1-13160-60-4F9F	Straight Reducer Coupling, 1/4-in. Female to 9/16-in. Female	10078145	\$71.50	
1-13160-60-6F9F	Straight Reducer Coupling, 3/8-in. Female to 9/16-in. Female	A-2437 10079531	\$91.00	

All AccuStream couplings include standard collars and glands.

Collars

AccuStream #	Description	Replaces	Price	
1-13157-60-4	Collar, 1/4 in.	A-2867 10078426 200788	\$4.25	
1-13157-60-6	Collar, 3/8 in.	A-2839 10078715 200274	\$5.00	
1-13157-60-9	Collar, 9/16 in.	10079119	\$8.00	

Glands

AccuStream #	Description	Replaces	Price	
1-13158-60-4	Gland, 1/4 in.	A-2866 10078459 200097	\$8.50	
1-13158-60-6	Gland, 3/8 in.	A-2838 10078129 200823	\$10.00	
1-13158-60-9	Gland, 9/16 in.	10078608	\$13.50	

High-pressure components

60K fittings

Plugs

AccuStream #	Description	Replaces	Price	
1-13159-60-4	Plug, 1/4 in.	A-0784-1 10078244	\$8.00	
1-13159-60-6	Plug, 3/8 in.	A-0784-2 10079523 200778	\$10.00	
1-13159-60-9	Plug, 9/16 in.	A-0784-3 10078772	\$13.00	

Adapters

AccuStream #	Description	Replaces	Price	
1-13162-60-4F6M	Adapter, 1/4-in. Female to 3/8-in. Male	A-0792-1 10079432 200785	\$55.50	
1-13162-60-4F9M	Adapter, 1/4-in. Female to 9/16-in. Male	10079580	\$55.50	
1-13162-60-6F4M	Adapter, 3/8-in. Female to 1/4-in. Male	A-1267 10079473	\$51.50	
1-13162-60-6F9M	Adapter, 3/8-in. Female to 9/16-in. Male	A-4691 10079457	\$58.50	
1-13162-60-9F4M	Adapter, 9/16-in. Female to 1/4-in. Male	A-0792-3	\$61.50	
1-13162-60-9F6M	Adapter, 9/16-in. Female to 3/8-in. Male	10079424 10079655	\$62.50	

Crosses

AccuStream #	Description	Replaces	Price	
1-13165-60-4	Cross, 1/4 in.	A-0777-1 10097228	\$80.00	
1-13165-60-6	Cross, 3/8 in.	A-0777-2 10078038	\$98.00	
1-14372	Cross, 3/8 in No fittings	—	\$75.00	
1-13165-60-9	Cross, 9/16 in.	A-0777-3 10079168	\$155.00	

All AccuStream crosses include standard collars and glands.



Tees

AccuStream #	Description	Replaces	Price	
1-13163-60-4	Tee, 1/4 in.	A-0776-1 10079481	\$68.00	
1-13163-60-6	Tee, 3/8 in.	A-0776-2 10078590 201526	\$75.00	
1-13535	Tee, 3/8 in No fittings	—	\$59.00	
1-13163-60-9	Tee, 9/16 in.	10079465	\$115.00	

All AccuStream tees include standard collars and glands.

60K fittings

Elbows

AccuStream #	Description	Replaces	Price	
1-13164-60-4	Elbow, 1/4 in.	A-0775-1 10079051	\$47.50	
1-13164-60-6	Elbow, 3/8 in.	A-0775-2 10078780 201514	\$65.00	
1-13164-60-9	Elbow, 9/16 in.	A-0775-3 10078525	\$89.00	
1-13534	Elbow, 3/8 in. No fittings	—	\$45.00	

All AccuStream elbows include standard collars and glands.

Two-way straight valves

AccuStream #	Description	Replaces	Price	
1-13166-60-4	Two-way Straight Valve, 1/4 in.	A-0788-1 10079259	\$146.00	
1-13166-60-6	Two-way Straight Valve, 3/8 in.	A-0788-3 10078863	\$188.00	
1-13166-60-9	Two-way Straight Valve, 9/16 in.	A-0788-5 10078889	\$250.00	

Two-way angle valves

AccuStream #	Description	Replaces	Price	
1-13167-60-4	Two-way Angle Valve, 1/4 in.	A-0787-1 10079002	\$147.00	
1-13167-60-6	Two-way Angle Valve, 3/8 in.	A-0787-3 10078749	\$190.00	
1-13167-60-9	Two-way Angle Valve, 9/16 in.	A-0787-5 10079275	\$230.00	

Three-way angle valves

AccuStream #	Description	Price	
1-13252-60-6	Three-way Angle Valve, 3/8 in.	\$225.00	
1-13252-60-9	Three-way Angle Valve, 9/16 in.	\$250.00	

Inline wyes

AccuStream #	Description	Price	
1-13614-6-4-4	Inline Wye, 3/8 in. to 1/4 in.	\$309.00	
1-13614-6-6-6	Inline Wye, 3/8 in. to 3/8 in.	\$350.00	

All AccuStream elbows include standard collars and glands.

Replacement parts suitable for:

High-pressure components

60K fittings



Antivibration assemblies

AccuStream #	Description	Price	
1-13495	Antivibration Assembly, 1/4 in. Commonly used with OMAX® systems	\$20.00	
1-14266	Antivibration Assembly, 3/8 in. Commonly used with OMAX® systems	\$22.00	

Antivibration assemblies are compatible with standard high-pressure products. Individual antivibration components are for use with AccuStream antivibration assemblies.

100K fittings

Swivels

AccuStream #	Description	Replaces	Price	
1-14493	90° Swivel Repair Kit, 1/4 in. Use with 1-14444 90° Swivel Assembly. Includes swivel seal rings, seal backup rings, swivel shafts, needle thrust bearings, antivibration assemblies, O-rings	015093-1	\$740.00	
1-14444	90° Swivel Assembly, 1/4 in. Use with 1-14493 90° Swivel Repair Kit. Includes swivel seal housing, swivel seals, seal hoops, swivel bearings, swivel bearing housings, swivel guides, bushings, needle thrust bearings, antivibration assemblies, O-rings	014922-1	\$1,900.00	

Antivibration assemblies are compatible with standard high-pressure products. Individual antivibration components are for use with AccuStream antivibration assemblies.

Antivibration assemblies

AccuStream #	Description	Price	
1-14369	Antivibration Assembly, 1/4 in.	\$68.00	

Nipples

1/4 inch

AccuStream #	Description	Replaces	Price
1-WJN4600275	Nipple, 1/4 in. × 2.75 in.	—	\$12.00
1-WJN4600600	Nipple, 1/4 in. × 6 in.	13168-60-4-6 A-0781-6 10103018	\$20.00
1-WJN4600800	Nipple, 1/4 in. × 8 in.	13168-60-4-8 A-0781-8	\$22.00
1-WJN4601000	Nipple, 1/4 in. × 10 in.	13168-60-4-10 10057636 80070519	\$24.00
1-WJN4609600	Nipple, 1/4 in. × 96 in. (8 ft)	204658-96	\$150.00

Lengths longer than 3.00 in. are available on request.

3/8 inch

AccuStream #	Description	Replaces	Price
1-WJN6600300	Nipple, 3/8 in. × 3 in.	13168-60-6-3	\$20.00
1-WJN6600400	Nipple, 3/8 in. × 4 in.	301337-4	\$24.00
1-WJN6600600	Nipple, 3/8 in. × 6 in.	13168-60-6-6	\$28.00
1-WJN6600800	Nipple, 3/8 in. × 8 in.	13168-60-6-8	\$35.00
1-WJN6601000	Nipple, 3/8 in. × 10 in.	13168-60-6-10	\$37.00
1-WJN6601200	Nipple, 3/8 in. × 12 in.	13168-60-6-12 301337-12	\$48.00
1-WJN6601400	Nipple, 3/8 in. × 14 in.	301337-14	\$53.00
1-WJN6601700	Nipple, 3/8 in. × 17 in.	301337-17	\$58.00
1-WJN6601800	Nipple, 3/8 in. × 18 in.	301337-18	\$59.00
1-WJN6602450	Nipple, 3/8 in. × 24-1/2 in.	301337-24.5	\$68.00
1-WJN6602600	Nipple, 3/8 in. × 26 in.	301337-26	\$70.00
1-WJN6603100	Nipple, 3/8 in. × 31 in.	301337-31	\$80.00
1-WJN6603600	Nipple, 3/8 in. × 36 in. (3 ft)	301337-36	\$92.00
1-WJN6604300	Nipple, 3/8 in. × 43 in.	301337-43	\$97.00
1-WJN6604800	Nipple, 3/8 in. × 48 in. (4 ft)	301337-48	\$116.00
1-WJN6605000	Nipple, 3/8 in. × 50 in.	301337-50	\$120.00
1-WJN6605500	Nipple, 3/8 in. × 55 in.	301337-55	\$130.00
1-WJN6606500	Nipple, 3/8 in. × 65 in.	301337-65	\$151.00
1-WJN6608900	Nipple, 3/8 in. × 89 in.	301337-89	\$201.00
1-WJN6614200	Nipple, 3/8 in. × 142 in.	301337-142	\$311.00
1-WJN6614300	Nipple, 3/8 in. × 143 in.	301337-143	\$313.00
1-WJN6616800	Nipple, 3/8 in. × 168 in. (14 ft)	301337-168	\$365.00

Lengths longer than 3.50 in. are available on request.

9/16 inch

AccuStream #	Description	Replaces	Price
1-WJN9600400	Nipple, 9/16 in. × 4.00 in.	13168-60-9-4	\$31.50
1-WJN9600800	Nipple, 9/16 in. × 8.00 in.	13168-60-9-8	\$43.00





Lengths longer than 3.50 in. are available on request.

Replacement parts suitable for:







High-pressure components

Hardware

Tube clamp pairs

AccuStream #	Description	Price	
1-12838	Tube Clamp Pair, 1/4 in.	\$2.60	
1-13144	Tube Clamp Pair, 3/8 in.	\$3.00	
1-13143	Tube Clamp Pair, 9/16 in.	\$3.15	
1-12837	Top Plate, 1/4 in. and 3/8 in.	\$1.60	
1-12830	Top Plate, 9/16 in.	\$1.60	







Inline filters

AccuStream #	Description	Replaces	Price	
1-13852	Inline Filter Assembly, 1/4-in. Female to female	—	\$229.00	
1-13853	Inline Filter Element, 1/4-in. Use with 1-13852 Inline Filter Assembly.	—	\$36.00	
1-11598	Inline Filter Assembly, 3/8-in. Female to male	—	\$210.00	
1-11600	Inline Filter Element, 3/8-in. Use with 1-11598 Inline Filter Assembly.	—	\$39.75	
1-13285	Inline Filter Assembly, 9/16-in. Female to female	—	\$3,000.00	
1-13222	Inline Filter Element, 9/16-in. Use with 1-13285 Inline Filter Assembly or E-Max port adapter filter.	304104	\$34.00	

Tools

Coning and threading tools

Tool sets

AccuStream #	Description	Replaces	Price	
1-13269	Tube Bender Assembly Use with 60k and 100k tubing.	—	\$795.00	
1-15492	Complete Coning and Threading Tool Set Includes 1/4-in., 3/8-in. and 9/16-in. tools	14536-60-CCT	\$1,630.00	
1-15440	Coning and Threading Tool Set Includes 1/4-in. and 3/8-in. tools	14536-60-4-6	\$865.00	
1-15493	Coning and Threading Tool Set Includes 1/4-in. tools	14536-60-4	\$625.00	
1-15494	Coning and Threading Tool Set Includes 3/8-in. tools	14536-60-6	\$625.00	
1-15495	Coning and Threading Tool Set Includes 9/16-in. tools	14536-60-9	\$700.00	
1-12798	Coning and Threading Oil, SULFLO #1	—	\$25.00	





All sets include a threading die, a collet, a cutter, a guide bushing, and coning and threading oil. Sets do not include tube bender assembly.

High-pressure components





Tools

Coning and threading tools





1/4 inch

AccuStream #	Description	Replaces	Price	
1-15439	Threading Die, 1/4 in., Left-hand	1/4-28LH	\$70.00	
1-15513	Guide Bushing, 1/4 in.	13154-60-4	\$40.00	
1-15496	Coning Tool Collet, 1/4 in.	13155-60-4	\$73.00	
1-15499	Coning Tool Cutter, 1/4 in.	13156-60-4	\$98.00	

3/8 inch









AccuStream #	Description	Replaces	Price	
1-15477	Threading Die, 3/8 in., Left-hand	3/8-24LH	\$70.00	
1-15514	Guide Bushing, 3/8 in.	13154-60-6	\$35.00	
1-15497	Coning Tool Collet, 3/8 in.	13155-60-6	\$73.00	
1-15500	Coning Tool Cutter, 3/8 in.	13156-60-6	\$98.00	

9/16 inch

AccuStream #	Description	Replaces	Price	
1-15478	Threading Die, 9/16 in., Left-hand	9/16-18LH	\$70.00	
1-15515	Guide Bushing, 9/16 in.	13154-60-9	\$38.00	
1-15498	Coning Tool Collet, 9/16 in.	13155-60-9	\$73.00	
1-15501	Coning Tool Cutter, 9/16 in.	13156-60-9	\$98.00	

Tools







Other tools

AccuStream #	Description	Replaces	Price	
1-12387	Seal Installation Tool Kit Use with Flow® pumps. Includes seal insertion push tool, seal insertion locator tool, seal insertion tool sleeve guide, seal installation washer	B-2291-1	\$250.00	
1-12029	Bleed-down Tool Use with Flow® pumps.	—	\$125.00	
1-13705	Cylinder Wrench Use with Flow® pumps.	A-6333	\$620.00	
1-13725	End-cap Spanner Wrench Use with Flow® pumps.	A-1628	\$100.00	
1-13972	Water Filter Wrench	—	\$6.30	
1-11210-XX	Lapping Paper Available in 12-, 15- and 30-micron sheets	—	\$3.15	
1-13281	Granite Surface Plate 9 in. × 12 in. × 2 in.	—	\$84.00	
1-13897	TDS Meter	—	\$52.00	

-XX indicates the availability of multiple sizes. Call us or visit AccuStream.com for details.

High-pressure components

Lubricants

AccuStream #	Description	Replaces	Price	
1-11448	Accu Goop Food-grade antiseize lubricant, 4 oz.	A-2185 10087385	\$25.00	
1-11111	Blue Goop Oil-based thread lubricant, 2 oz.	A-2185 302692 20460486	\$16.00	
1-13537	Pure Goop Halocarbon-based thread lubricant, 1 oz.	10084440	\$44.00	
1-11447	High-vacuum Grease Seal O-ring lubricant, 5 oz.	200006	\$1.60	
1-11136	High-vacuum Grease 5.3 oz.	A-4689	\$35.00	
1-14511	Extreme-pressure Antiscoring Lubricant 0.25 oz.	202496	\$3.15	
1-13969	O-ring Lubricant 4 oz.	—	\$12.50	

Gauges

AccuStream #	Description	Price	
1-12028	Gauge, Back-mount	\$850.00	
1-12106	Gauge, Bottom-mount	\$845.00	

A team to keep you up and running

Like you, we know that uptime is money. That's why we've put together an exceptional support team and all the information tools you need to stay ahead of unexpected problems and delays. It's all part of our commitment to service.

- Voicemail-free, expert waterjet support during business hours
- Global distribution ensures fast response and speedy parts delivery
- Hypertherm Waterjet Assistant mobile application for iOS and Android
- Online technical guides with step-by-step repair instructions (<http://assist.hypertherm.com>)
- Available on-site product training

We ship faster so you're back to work sooner

Our goal as owners is to ensure that you get what you need when you need it.

Place your order by 2:30 PM CST and we will ship it the same day.

From our job shop roots, we know how it feels to be down, so we will do everything we can to keep you cutting.



Waterjet Assistant gives you instant access to detailed, step-by-step maintenance and repair procedures, including part numbers.

Get the mobile app

Download the Hypertherm Waterjet Assistant mobile app from the App Store for iOS or from Google Play for Android using the links below.



sales@accustream.com | www.accustream.com | (866) 566-7099

Hypertherm, DiaLine, HyPrecision, and AccuStream are trademarks of Hypertherm, Inc. and may be registered in the United States and/or other countries. All other trademarks are the properties of their respective owners.

Please visit www.hypertherm.com/patents for more details about Hypertherm patent numbers and types.

© 11/2020 Hypertherm, Inc. Revision 4
897010

As 100% Associate-owners, we are all focused on delivering a superior customer experience. www.hypertherm.com/ownership

Environmental stewardship is one of Hypertherm's core values. www.hypertherm.com/environment

Hypertherm[®]
SHAPING POSSIBILITY[®]

100% Associate-owned

