

Hypertherm®

***AccuValve On/Off Valve
A2 Cutting Head
DiaLine Cutting Head***

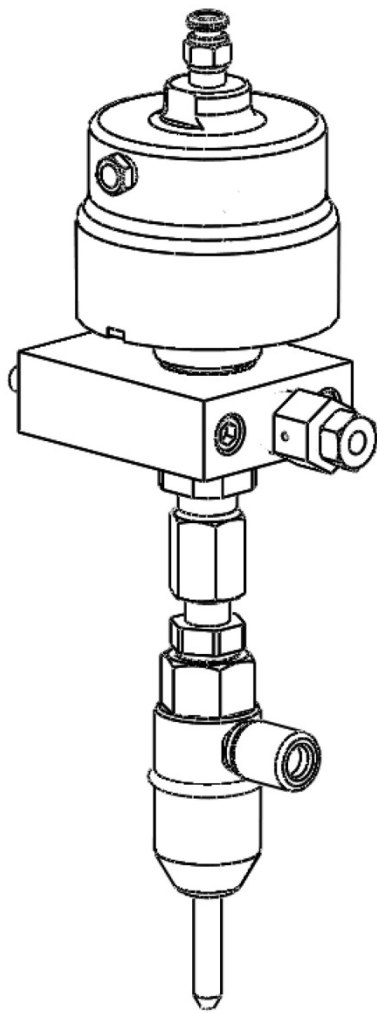

Instruction Manual

810700 | Revision 0 | English

AccuValve On/Off Valve, A2 Cutting Head, and DiaLine Cutting Head

Instruction manual

Revision 0

November 2013

Original instructions

Hypertherm Waterjet
309 5th Ave NW
New Brighton, MN 55112
+1 866-566- 7099
+1 651-294-8620 fax

© 11/2013 Hypertherm Inc. All rights reserved. No part of this document might be reproduced, transmitted, transcribed, stored in a retrieval system or translated into any language or any form by any means without the written permission of Hypertherm Inc.

Warranty

Failure to follow and apply these instructions is considered to be misuse. Personal injury, product damage, or failure caused by misuse are not covered by the Hypertherm Inc. warranty.

Hypertherm, Inc. warrants that its Products shall be free from defects in materials and workmanship, if Hypertherm is notified of a defect (i) with respect to the intensifier pumps within a period of two (2) years from the date of its delivery to you, and (ii) with respect to the cutting head assemblies within a period of one (1) year from its date of delivery to you, with the exception of Diamond orifices, which shall be within a period of six hundred (600) hours of use.

General

This warranty shall not apply to any Product which has been incorrectly installed, modified, or otherwise damaged. Hypertherm, at its sole option, shall repair, replace, or adjust, free of charge, any defective Products covered by this warranty which shall be returned with Hypertherm's prior authorization (which shall not be unreasonably withheld), properly packed, to a Hypertherm facility, or to an authorized Hypertherm repair facility, all costs, insurance and freight prepaid. Hypertherm shall not be liable for any repairs, replacement, or adjustments of Products covered by this warranty, except those made pursuant to this paragraph or with Hypertherm's prior written consent.

The warranty above is exclusive and is in lieu of all other warranties, express, implied, statutory, or otherwise with respect to the Products or as to the results which may be obtained there from, and all implied warranties or conditions of quality or of merchantability or fitness for a particular purpose or against infringement. The foregoing shall constitute the sole and exclusive remedy for any breach by Hypertherm of its warranty. Distributors/OEMs may offer different or additional warranties, but Distributors/OEMs are not authorized to give any additional warranty protection to you or make any representation to you purporting to be binding upon Hypertherm.

Patent indemnity

Except only in cases of products not manufactured by Hypertherm or manufactured by a person other than Hypertherm not in strict conformity with Hypertherm's specifications and in cases of designs, processes, formula, or combinations not developed or purported to be developed by Hypertherm, Hypertherm will defend or settle, at its own expense, any suit or proceeding brought against you alleging that the use of the Hypertherm Product, alone and not in combination with any other product not supplied by Hypertherm, infringes any patent of any third party. You shall notify Hypertherm promptly upon learning of any action or threatened action in connection with any such alleged infringement, and Hypertherm's obligation to indemnify shall be conditioned upon Hypertherm's sole control of, and the indemnified party's cooperation and assistance in, the defense of the claim.

Limitation of liability

In no event shall Hypertherm be liable to any person or entity for any incidental, consequential, indirect, or punitive damages (including but not limited to lost profits) regardless of whether such liability is based on breach of contract, tort, strict liability, breach of warranties, failure of essential purpose or otherwise and even if advised of the possibility of such damages.

Liability cap

In no event shall Hypertherm's liability, whether such liability is based on breach of contract, tort, strict liability, breach of warranties, failure of essential purpose or otherwise, for any claim action suit or proceeding arising out of or relating to the use of the Products exceed in the aggregate the amount paid for the Products that gave rise to such claim.

Insurance

At all times the OEM will have and maintain insurance in such quantities and types and with coverage sufficient and appropriate to defend and to hold Hypertherm harmless in the event of any cause of action arising from the use of the Products.

National and local codes

National and local codes governing installation, plumbing, and electrical installation shall take precedent over any instructions contained in any Hypertherm manual. **In no event** shall Hypertherm be liable for injury to persons or property damage by reason of any code violation or poor work practices.

Transfer of rights

You may transfer any remaining rights you may have hereunder only in connection with the sale of all or substantially all of your assets or capital stock to a successor in interest who agrees to be bound by all of the terms and conditions of this Warranty.

Diamond warranty

Hypertherm products are guaranteed to function properly. If there are any startup problems, contact Hypertherm to resolve the issue.

Hypertherm diamond orifice assemblies come with a 500 hour limited warranty against manufacturer defect. Damage caused by contamination is not covered. To avoid inline contaminants from damaging the diamond orifice assemblies, Hypertherm suggests using a thimble filter assembly.

Disclaimer

HyPrecision is a trademark of Hypertherm Inc. and might be registered in the United States and/or other countries. All other trademarks are the properties of their respective owners.

Information in this instruction manual is believed to be complete and reliable. While Hypertherm Inc. has made every effort to provide comprehensive instructions, good engineering and safety practices should always be used.

Hypertherm Inc. manufactures products to meet international quality standards. Genuine parts and accessories are designed, tested, and used in the equipment to consistent product quality and performance. The use of parts and accessories from other vendors can affect the performance and safety features of this equipment adversely. The failure to properly use authorized Hypertherm parts and accessories is considered to be misuse. Damage to or failure of equipment that is caused by misuse is not covered by the Hypertherm warranty. The modification or removal of Hypertherm components can impair the safe use of this equipment.

This instruction manual provides information about how to safely install, operate, and maintain HyPrecision 50S, 60S, 75S, 100D, and 150D Intensifier Pumps. Read the manual completely before installing, operating, or performing maintenance on this equipment. The instruction manual is a permanent part of the equipment and should be kept available for reference.

Hypertherm Inc. reserves the right to make changes to the information in this instruction manual, make product updates, or to discontinue any product identified in this publication without notice,

Hypertherm Inc. is not liable for technical or editorial errors or omissions this instruction manual, nor is it liable for incidental or consequential damages resulting from the use of information contained in this instruction manual.

These instructions are not intended to cover all details or variations in equipment types nor to provide for every possible issue concerning the installation, operation, or maintenance of this equipment.

Electrical or mechanical modifications made to this equipment without the express written consent of Hypertherm Inc. will void all warranties and might void third-party (CE, UL, CSA, etc.) safety certifications. Unauthorized modifications can result in safety risks and/or damage to this equipment.



Table of contents

Warranty	3
General	3
Patent indemnity	3
Limitation of liability	3
Liability cap	4
Insurance	4
National and local codes	4
Transfer of rights	4
Diamond warranty	4
Disclaimer	5
Table of contents	6
Safety	8
General safety	9
Cutting head safety	10
High-pressure water system safety	11
Introduction	12
Inlet cutting water requirements	12
Maximizing diamond and ruby orifice life	13
AccuValve On/Off Valve	14
Specifications	14
Mounting Collar	14
Valve body	16
Removing the components	17
Actuator	18
Cutting heads	21
DiaLine cutting head	22
Setup and installation	23
Maintenance	24
A2 Cutting Head	26
Installation	26
Replaceable parts	27
Nozzle	27

Orifice	27
Filtration	27
Adapter (nozzle tube)	27
Exterior abrasion	27
Optimal cutting parameters.....	28
Troubleshooting	29
Clearing plugged nozzles	29
Waterjet/abrasivejet stream.....	29
Cutting head.....	29
Leak points (causes and solutions).....	30
Drawings and parts lists.....	31
Actuator assembly12828 and 13732.....	31
Complete cutting head parts list	32

Safety

This instruction manual contains symbols that are intended to alert the user to potential hazards and/or information.

 DANGER	<p><i>This symbol indicates safety instructions. Noncompliance can result in severe injury or death.</i></p>
 WARNING	<p><i>This symbol indicates safety instructions. Noncompliance can result in serious injury, death, or property or equipment damage.</i></p>
 WARNING	<ul style="list-style-type: none"> • A waterjet is a cutting tool. The water stream can cause serious injuries. • Abrasive waterjets eject a mixture of water and abrasive that can be injected into the tissue, leading to a serious infection. Seek immediate surgical attention after contact with any high-pressure stream of fluid.
 CAUTION	<p><i>This symbol indicates safety instructions. Noncompliance can result in injury.</i></p>
 IMPORTANT	<p><i>This symbol indicates important information or procedures. Noncompliance can result in property or equipment damage.</i></p>
	<p><i>A high-pressure waterjet can cause eye injury. Wear eye protection when operating or working near this equipment.</i></p>
	<p><i>To reduce the risk of hearing loss, wear ear protection when operating or working near this equipment.</i></p>
	<p><i>Airborne contaminants or suspended particles might result when cutting certain materials. Wear respiratory protection when these conditions are present.</i></p>
	<p><i>This symbol indicates a mandatory action.</i></p>
	<p><i>This symbol indicates a prohibited action.</i></p>
	<p>The CE marking indicates that a product complies with all relevant European directives and standards. Hypertherm equipment with a CE marking located on or near the data plate has been tested for compliance with Machinery Directive 2006/42/EC and Directive 2004/108/EC.</p>

General safety

Hypertherm products are designed, developed, and manufactured with great care and commitment to continuous quality control and safety. The end user is responsible for the safe use of this equipment.

These instructions are intended to familiarize the user with the pump and its components, its operation and maintenance, and to identify hazards associated with operation and maintenance.

Keep these instructions near the pump.

To prevent injury to personnel or damage to equipment, observe all safety precautions. People who operate and/or maintain this pump must:

- read and understand these instructions before installing, operating, and performing maintenance on this equipment.
- be trained and qualified to perform tasks related to the operation and maintenance of this equipment. People who have not been trained to safely operate a waterjet should not be allowed near the system.
- know how to use common hand tools safely.
- keep the work area clean and free of fluid spills.
- clean and inspect the equipment regularly and fix all problems immediately.
- use appropriate safety gear. Failure to wear appropriate safety gear can result in injury or death. Eye, ear, and respiratory protection, safety shoes, and other personal protective equipment are strongly recommended.

The safety precautions in this manual are general and cannot cover every possible situation. Hypertherm Inc. acknowledges that unforeseen situations due to site variability, improper maintenance, and other events can cause equipment damage, injury, or death. It is the user's responsibility to identify additional hazards and take the steps necessary to minimize risks.

Operator qualification and training

People who install, operate, inspect, and maintain this pump must be qualified to carry out the required tasks. Appropriate training is required. This training should include how to:

- start and stop the pump.
- operate the controls.
- perform maintenance procedures, including lockout-tagout, if appropriate.
- identify and respond to all equipment fault indicators.
- identify conditions and actions that can lead to injury to people and damage to the equipment.

Emergency medical treatment

Injuries caused by high-pressure water equipment require immediate attention by a qualified surgeon. A delay in seeking medical attention can result in a serious infection and possible amputation.

Because circulation can be compromised, do not apply heat to the injury. Keep the injured person awake and elevate the affected body part(s), if possible.

Tell emergency responders or medical staff that the victim has been exposed to a high-pressure mixture of water and abrasives.

Emergency medical information

It is important that waterjet operators carry a waterproof emergency medical tag or card that describes their work and the nature of injuries associated with using waterjet cutting equipment. The card below can be copied, cut out, and folded. It provides information that must be provided to medical staff or emergency responders.

 <h1>MEDICAL ALERT</h1> <p>This card is to be carried by people who work with high-pressure waterjet equipment.</p> <p>Seek immediate medical treatment for all high-pressure waterjet injuries.</p> <p>Hypertherm 309 5th Ave. NW New Brighton, MN 55112-3239 USA +1 866 566-7099</p>	<p>The cardholder has been exposed to a high-pressure waterjet of up to 4 137 bar (60,000 psi) and a velocity of 609 meters/second (2,000 feet/second).</p> <ul style="list-style-type: none">• Provide the same evaluation performed for a contact gunshot injury. Initial injury management should include a thorough neurovascular examination.• Use x-ray to assess subcutaneous air and foreign bodies. Acute compartment syndrome is possible.• Obtain surgical consultation. Surgical decompression and exploration might be necessary.• Aggressive irrigation and debridement is recommended.• Unusual infections with microaerophilic organisms have been reported. These organisms include Gram-negative pathogens, such as those found in sewage. Administer broad-spectrum intravenous antibiotics.
--	---

Cutting head safety

- Before starting any service or maintenance, to the valve and/or cutting heads ALL water pressure must be removed from the system.
- Isolate the water pressure from the on/off valve by dumping the pump pressure or closing the manual isolation valve.
- Read the instructions in all sections of this manual before performing any maintenance on the valve. Important information is contained throughout this manual to minimize hazards and wear on the machine.
- Use the proper tools required for specific procedures. When special tools are called for, make sure to use them because they are specifically designed to make the job easier and prevent damage to the equipment.
- Remove all tools from the work area before starting the machine.

High-pressure water system safety

Never work on any high-pressure component or loosen any high-pressure fittings without first bleeding the system to ensure that there is no high-pressure water present. Follow all instructions and safety recommendations in this manual.



WARNING

Always avoid contact with the stream of water. Seek immediate surgical attention if you come in contact with any high-pressure stream of fluid.

- Do not come in contact with the high-pressure water. HP water can penetrate any part of the human body and cause severe infection or death if not treated properly. Seek immediate surgical attention if you come in contact with any high-pressure stream of fluid.
- Do not try to repair a leak in an HP water fitting when the system is pressurized. A leak at a sealing surface can cause a hazardous spray of water. Shut off the motor and double check the HP water pressure is relieved down the drain before servicing any high-pressure plumbing.
- Plumbing supports and guides must be used for all HP tubing exiting the pump. Failure to do so can introduce excessive bending stress and fatigue through vibration causing a premature failure of the plumbing, and heighten the risk of personal injury due to an unexpected rupture.
- Always use two wrenches when tightening or loosening HP connections: one for the gland nut and one for the fitting. Using one wrench only will introduce excessive bending stress to the plumbing causing premature failure.
- Always use high-pressure piping that is rated for the pressures you will be operating with. This pump is capable of outputting 60,000 psi of water.
- Make sure all connections are properly tightened after performing service or maintenance.
- Keep hands and body away from pinholes and nozzles, which eject fluids under high pressure.
- Never check for hydraulic leaks with your hand: use a piece of cardboard or other material.
- Do not expose skin to a pressurized leak.
- Wear appropriate protective equipment including heavy gloves and safety glasses.
- Do not attempt to tighten or loosen any mechanical connection unless the machine is powered OFF and all system pressure has been relieved.

Introduction

This manual describes the installation, use and maintenance of the AccuValve cutting heads. The valve is designed for flexible production in either pure water or abrasive waterjet cutting applications.

The DiaLine head is available for use with either .281 or .300 OD nozzles while the A2 head accepts .300 OD nozzles. Both cutting heads contain a quick disconnect nozzle nut which can be hand tightened for the removal and adjustment of the nozzle.

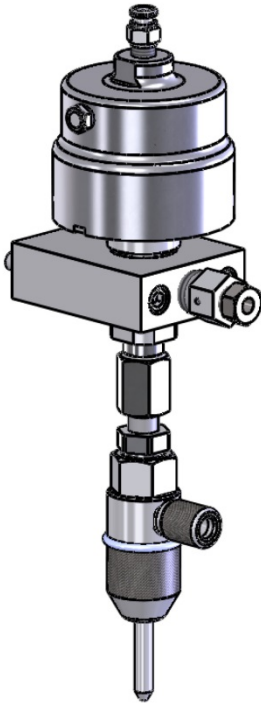

AccuValve with the DiaLine cutting head

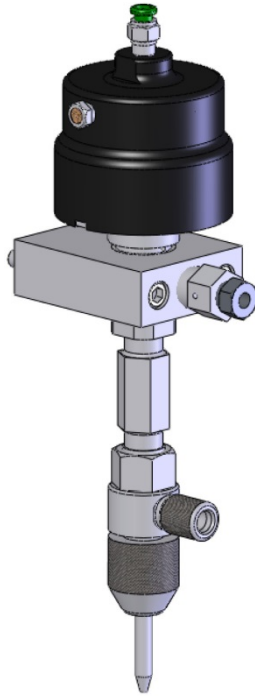

AccuValve with the A2 cutting head

Inlet cutting water requirements

Inlet cutting water requirements and testing

The inlet water should have a pH of 6 to 8 and be clear, odorless, and free of biological materials. To insure the incoming water will not have an adverse affect on the diamond life, the water quality can be tested with the TDS meter.

In other cases it should be analyzed for the following:

- pH
- Silica content
- Total dissolved solids (TDS)

Water treatment guidelines

Testing your inlet cutting water with a TDS meter allows you to quickly and effectively monitor the quality of your inlet water and make adjustment accordingly

High Quality Water		TDS < 50 ppm	No treatment required	No action
Good Quality Water		50 ppm < TDS < 150 ppm	Soften only	Contact local water treatment specialist
Medium Quality Water		150 ppm < TDS < 250 ppm	Soften or TDS removal	Specialist or RO system
Poor Quality Water	TDS > 250 ppm Silica > 15 ppm	TDS removal	RO system available through Hypertherm	



NOTE: : Do not treat to 5 ppm or less: Water of this high of purity is overly aggressive and will damage stainless steel components.

Maximizing diamond and ruby orifice life

1. When changing an orifice, make sure you have clean hands and a clean work area.
2. When a new orifice is installed the adapter above the orifice has no water contained inside. You need to open the cutting head and bring the water pressure up gradually as to not pressure shock the top of the orifice.
3. Too much abrasive being fed to the cutting head will cause premature orifice failure. Confirm you are not using excessive amounts of abrasive.
4. At the end of your cut shut the abrasive off first. This will clear out the abrasive feed line and help stop abrasive migrating up toward the orifice, causing premature failure. The time should be ½ a second. This may not be possible if you are cutting material that delaminates.
5. If the orifice life suddenly goes down, check to see if you have a high-pressure inline filter. If it is clogged it will start to come apart and take out your orifice.

Purging the lines may be necessary after changing high-pressure components as contaminants may cause your orifice to fail soon after doing maintenance the intensifier.

AccuValve On/Off Valve

The *Accustream On/Off Valve* (AccuValve) is an ultra-high pressure valve used to control the flow of water for waterjet cutting applications.

The On/Off valve is a normally closed (air to open, spring closed) valve that can be direct mounted to the cutting head for water or abrasivejet cutting see Mounting Collar (below), or it can be remote mounted with separate plumbing from the valve to the cutting head. The valve can also be remotely mounted on the cutting head.

Specifications

Fluid pressure	
Operating pressure	60,000 psi water max
Actuator Air Pressure	60– 80 psi to open
Weight	
Valve Only	2.5 pounds
Valve w/Mntg Collar and Abrasive Head	5.5 pounds
Size	
Valve Only	3.1" dia x 5"
Valve with Abrasive Head	3.1" dia x 11.6"

Mounting Collar

Installation for 11198 and 13878

The AccuValve is normally mounted with the mounting collar assembly 11198 (shown below) using the 1/4" HP inlet connection. The thimble filter comes standard with the DiaLine assembly. This filter can be purchased separately. Other mounting options are also available.

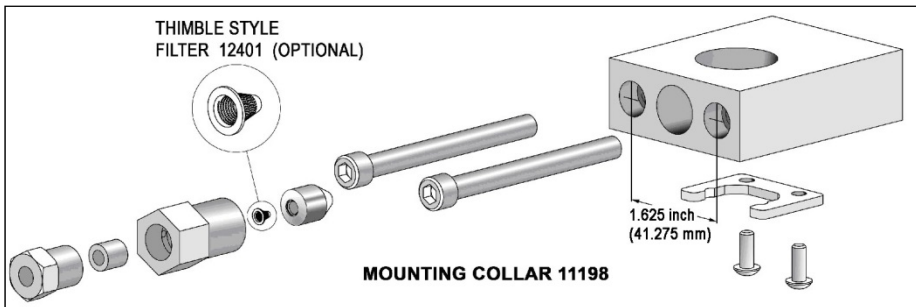

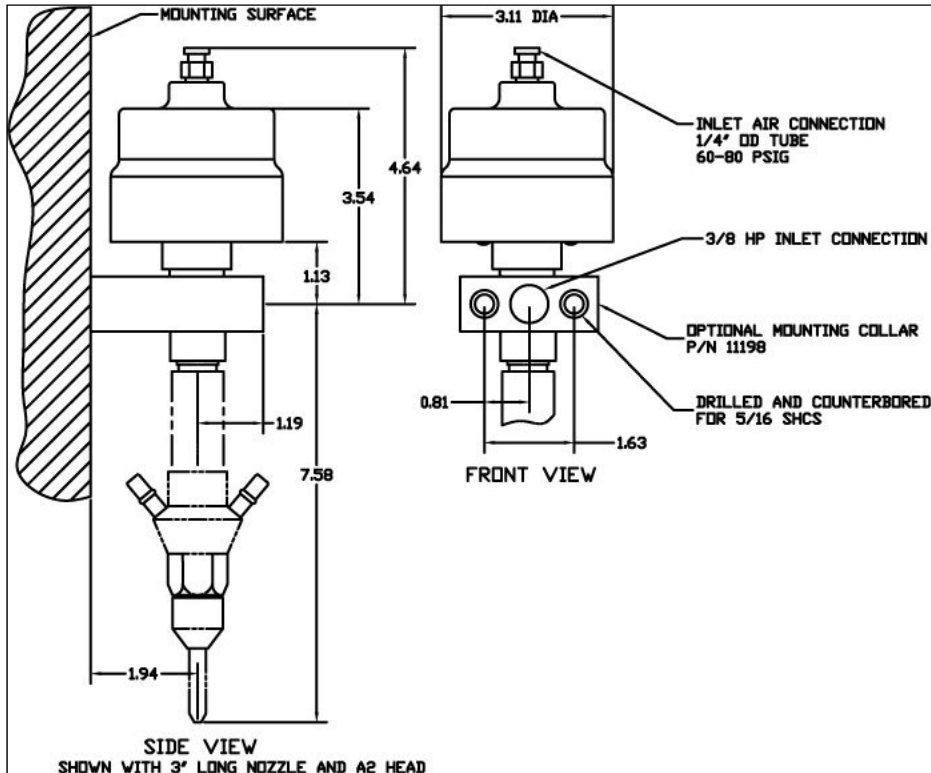

- To install the mounting collar, transfer, drill and tap two 5/16– 18UNC holes into the Z-axis faceplate.

NOTE: For proper alignment, the mounting holes must be 1.625 in. (41.275 mm) from center of holes apart. See illustration (above).
- With the *adapter* and *seat* removed from the valve body, slide the valve body down into the collar and align the high-pressure water inlet hole with the collar.
- Align the bottom of the seal *weep hole* with the top of the mounting collar. Carefully thread and tighten the inlet fitting into the side of the valve body.

NOTE: Make sure that the mating cones are properly aligned before torquing the connection.
- Connect the inlet water connection to the inlet adapter. This connection is normally made with 1/4" OD x .083 ID 60,000 psi rated stainless steel tubing. Tighten all high-pressure connections with a two wrench technique.
- Connect regulated air pressure to the valve actuator.
- Set the air pressure to 70 psi. The valve actuator should be controlled with a 3-way solenoid valve. When the solenoid valve is energized, the actuator will pressurize and the actuator should exhaust when the solenoid valve is de-energized.

NOTE: When installing a new valve it is best to flush the lines at low pressure with the adapter and seat out of the valve body. This step is optional.
- Put AccuGoop at the seat hole and on the mating surfaces. With water pressure off, turn on the actuator. This removes spring force from the needle.
- Thread the adapter with the seat on top into the valve body. Tighten the adapter to the valve body with two wrenches.
- Turn the actuator off, this will seat the needle into the seat.

10. Turn on the pump or open up the manual isolation valve to apply high-pressure water to the valve.
11. Flush the lines by actuating the on/off valve with brief pulses. After five to ten pulses, the lines should be flushed and free of contamination.

The cutting head can now be installed onto the adapter. See the Accustream cutting head manual.

Valve body

Maintenance

The valve consists of two parts; the actuator and the high-pressure valve area. The actuator can go for extended periods without service. The high-pressure valve components require service more frequently.

Components

The AccuStream ON/OFF repair kit #11328 contains the following parts.

11010-SEAT, 11562-NEEDLE, 11043-VALVE SEAL, 12178-NEEDLE GUIDE, Dowel Rod.

When to install new valve components

- Replace the needle and seat when the nozzle tip is dripping.
- Install a new seal when the top weep hole in the valve body is dripping.
- Replace the needle guide when the fit between the guide and needle is loose. A worn guide ID may cause seals to fail due to ID extrusion.
- Dripping from the inlet water connection usually indicates that the connection is not tight enough.

Removing the components

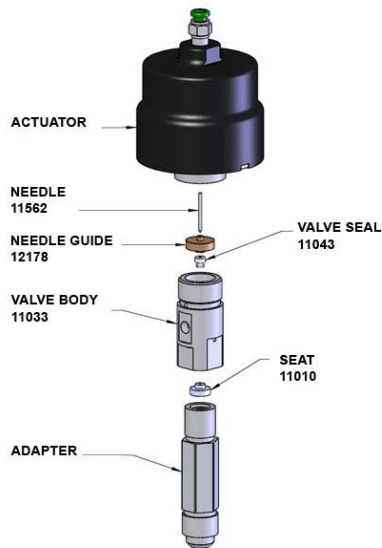

1. Isolate the water pressure from the **ON/OFF** valve by dumping the pump pressure or *closing* the manual isolation valve.
2. With the actuator pressurized with air, unthread the adapter from the bottom of the valve body and remove the seat.
3. Turn the air to the actuator **OFF** and **REMOVE** the air line from the top of the actuator.
4. Unthread the actuator from the top of the valve body.
5. With the valve body still in the mounting collar, remove the seal, needle guide and needle by pushing the *dowel rod* up through the bottom of the valve body.
6. Thoroughly wash out the interior of the valve body before replacing components.

Installing new components



1. Insert the needle through the needle guide and seal as shown. Ensuring the small diameter of the needle guide faces towards the actuator and the red O-ring on the valve seal faces downward in the valve body.
2. Lubricate the O-ring on the valve seal and insert into the top of the valve body until the needle guide is flush to the top of the bore.
3. Thread (hand tighten) the actuator onto the top of the valve body. Reattach air to the actuator and turn actuator air pressure on to pull the needle valve up.
4. Apply Blue Goop to the surfaces at the top of seat and to the surface of the seat where the needle seats.
5. Place the seat into the pilot diameter at the top of the adapter and thread the adapter into the bottom of the valve. Torque the adapter to the valve using the two-wrench technique.
6. Turn off the air to the actuator.
7. Apply water pressure to the valve assembly to verify there are no leaks. Before installing the cutting head quickly cycle the valve on and off a few times to purge all contaminants. Reinstall the cutting head and commence cutting.

Actuator

Maintenance

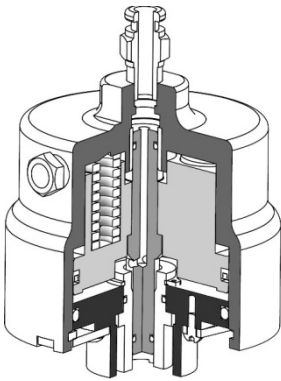

The actuator is not a regularly serviced item. It is recommended, that the actuator be disassembled annually. The actuator should be thoroughly cleaned and all the internal parts inspected for wear.

If the actuator does not appear to be functioning properly, first check the actuator for air leaks. There should never be air leaking from the bottom area of the actuator. With the jet on there should be no air leaking from the exhaust vent. Air leaks indicate that O-rings need to be replaced.

Over time, abrasives can accumulate inside the housing. The O-rings, will show wear and the springs may lose some of their force. Replace all worn parts: springs, exhaust vent, piston seal and O-rings.

Housing disassembly

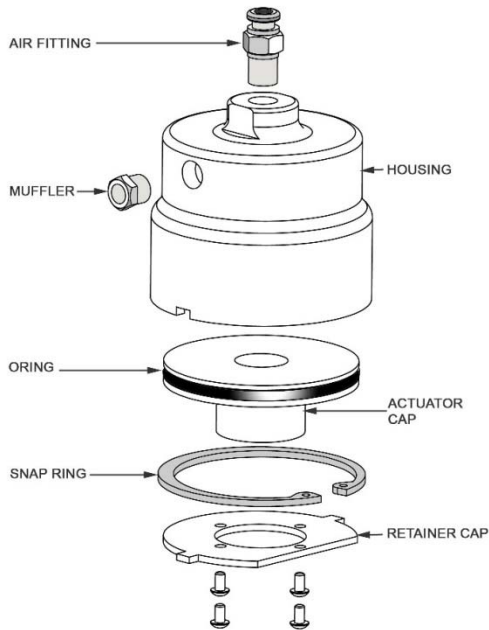

1. Remove the air fitting from the top of the actuator.
 2. Remove the Retainer cap from the bottom of the actuator.
 3. Place the actuator in a large vise and tighten the vise just enough to apply slight compression to the actuator springs.
 4. Use a locking type snap ring pliers to close (compress) the retaining ring that secures the actuator cap into the housing.
 5. Carefully open the vise while verifying that the cap is coming free from the housing.
- NOTE: The actuator contains high force springs and should be serviced with caution!

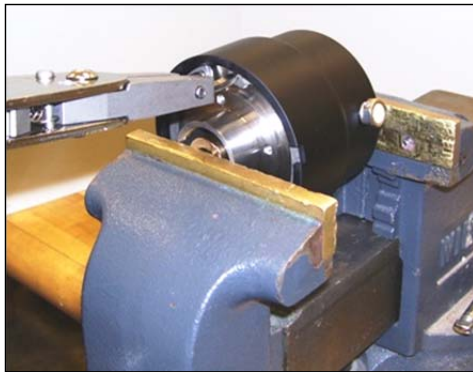

Valve in vise

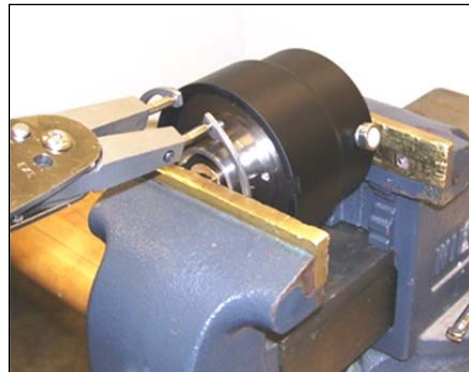

Snap ring removed

Housing reassembly

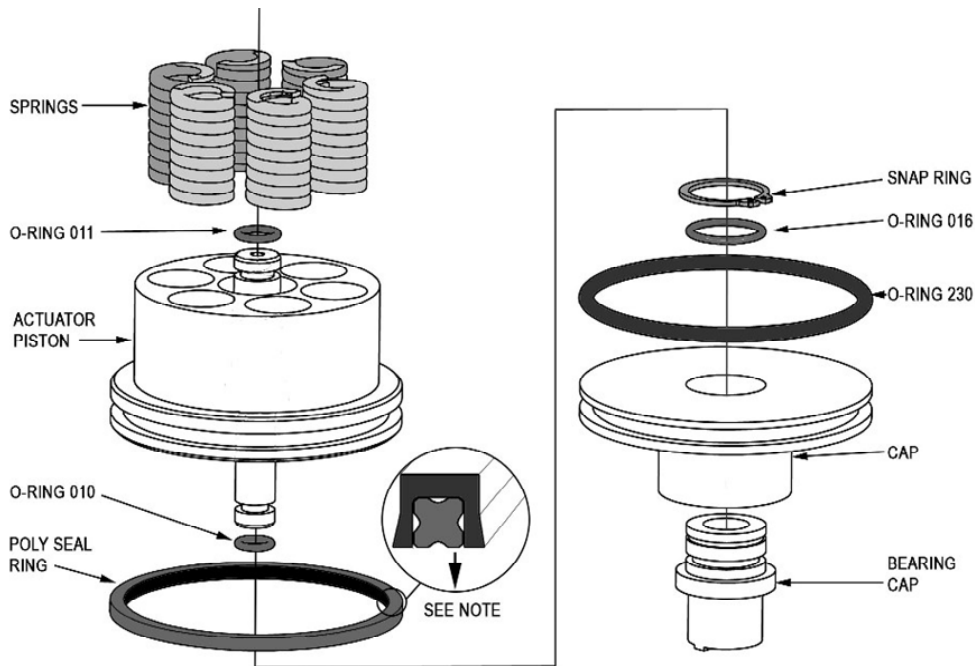

Use the AccuValve Actuator rebuild kit.

1. Inspect and apply O-ring grease to the outside of all O-rings
2. Install the new O-rings on both ends of the shaft. Make note of the O-ring sizes and their location.
3. Install the poly seal ring on the actuator piston with the lip on the seal facing in the right direction
4. Install the O-ring on the bearing cap
5. After inspecting and cleaning, replace at least: exhaust vent, two O-rings on the actuator shaft, 1 lip seal on piston OD, and all six springs.
NOTE: The poly seal ring should be oriented on the piston so that the lip side of the seal is facing down toward the air cylinder area of the actuator.
6. Align the retainer cap tabs with the slots in the housing.
7. Place the assembled parts with the retaining ring in place, into a vise to hold the assembly together.
8. Tighten the vise until the outer diameter of the cap just aligns with the inner groove on the housing.
9. Squeeze the retaining ring with the snap ring pliers and insert the ring inside the groove in the housing body.
10. Release the retaining ring and let the ring snap into the groove.
11. Work the vise in and out slightly to ensure that the retaining ring is, seated securely.
12. Loosen the vise and remove the actuator.
13. Reattach the retainer cap to the bottom of the actuator.

Cutting heads

The AccuValve may be used with either the DiaLine or A2 cutting head. The other options available include the carbide and rubber splashguards, water nuts, alternative adapters, ruby and diamond orifices, and many different nozzle sizes. Consult the Valve/Head option drawing for specific part numbers.

The key to effective operation is eliminating contamination above the orifice. Proper flushing and rinsing will maximize orifice life. Areas upstream from the orifice should be flushed and washed with water to eliminate any particles that can damage the orifices.

Caution: Verify that there is no water pressure in the valve before making any changes to the valve or its components.

DiaLine cutting head

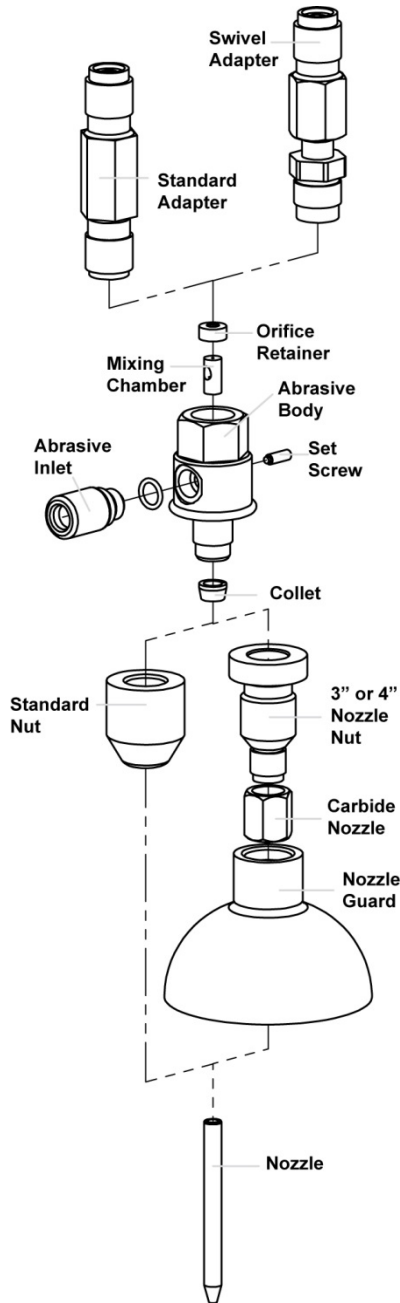

The DiaLine Cutting Head is normally used with diamond orifices for improved cutting performance and superior life. Ruby orifices are also available. A new feature of the DiaLine cutting head is that the diamond orifice and mixing chamber are replaceable. Also new are swivel adapters for proper positioning of your abrasive inlet. The nozzle nut provides an additional alignment to the nozzle and helps in the removal of the nozzle if it is broken. To minimize wear from spray back, Accustream now offers nozzle guards for 3 and 4" nozzles. Also available are 3/16" inlets, for those using smaller abrasive feed lines.

Setup and installation

Installing the nozzle and nozzle nut

Standard nozzle nut

1. Loosen the standard nozzle nut and remove the nozzle collet from the inside of the standard nozzle nut.
2. Slide the collet onto the end of your selected nozzle making sure the tapered side is facing towards the bottom end of the nozzle and slide the nozzle into the abrasive body until it bottoms out.
3. Thread the nut to the abrasive body making sure the collet remains butted up to the abrasive body.
4. Hand-tight is sufficient.

3" or 4" nozzle guards

1. Loosen the nozzle nut and remove the nozzle collet from the inside of the nozzle nut.
2. Slide the collet onto the end of your selected nozzle and slide the nozzle into the abrasive body until it bottoms out.
3. Thread the carbide nut to the nozzle nut.
4. Thread the nozzle nut to the abrasive body making sure the collet remains butted up to the abrasive body.
5. Hand tight is sufficient. Install the rubber nozzle guard by sliding onto the end of the carbide nut.
6. Press to fit.

Installing the orifice

Installing the assembled head

1. Thread the DiaLine head onto the bottom of the adapter (make sure the collar on the bottom of the adapter is threaded on completely) and torque to seal. Use 3/8" OD x 1/4" ID or 3/16" OD x 1/8" ID hose or tube (depending on abrasive inlet chosen) for feeding abrasive into the head.
2. Push the hose into the connector until it bottoms. The hose may feel tight and it may be necessary to put a light lubricant on the OD at its end.

Maintenance

Replacing the orifice

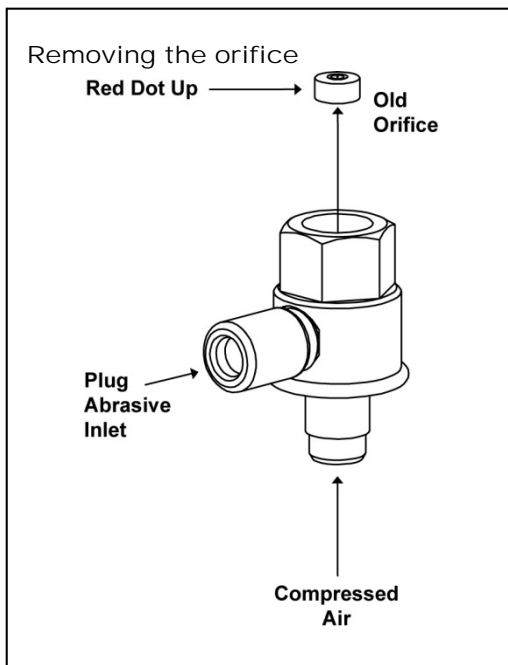

Removing the old orifice

1. Remove the DiaLine head from the adapter.
2. Remove the inlet connector, nozzle nut and nozzle
3. Block the inlet connector hole and blow air through the nozzle nut side of the abrasive body to force the old orifice out.
4. Install the orifice retainer flat side down into the cutting head body. The top of the retainer has a slight conical shape and holds the jewel orifice. This side should still be visible after installing the orifice retainer.

Installing the new orifice

1. Install the orifice retainer flat side down into the cutting head body. the top of the retainer has a slight conical shape and holds the jewel orifice. This side should still be visible after installing the orifice retainer.
2. Apply a light coat of HP lubricant to the top face of the orifice retainer and threads of the adapter.

Replacing the mixing chamber

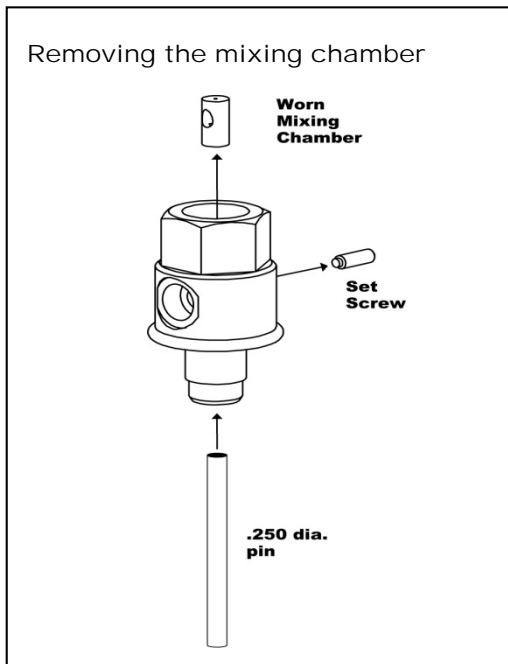

Removing the worn mixing chamber

1. Remove the inlet connector, nozzle nut, and collet from the abrasive body. Loosen the setscrew that holds the mixing chamber a few turns.
2. Push the orifice retainer and mixing chamber up through the top of the abrasive body with a .250 dia. pin.

Installing the new mixing chamber

1. Place the orifice retainer in the bore with the cone side up and hold it down with a finger.
2. Slide the new mixing chamber into the body up from the bottom until it is touching the bottom of the orifice retainer and align the abrasive inlet hole of the chamber with the inlet hole of the abrasive body.
3. Tighten the setscrew to secure the mixing chamber.
4. Reassemble the DiaLine head and thread the head back onto the adapter.

A2 Cutting Head

The A2 Cutting Head has two abrasive inlets to allow a connection to the head from either side depending on the system setup and configuration. A nut and plastic collet hold the nozzle in location. Ruby orifices and long life diamond orifices are available. Diamond orifices include a *carbide wear disc* to protect the bottom of the orifice from abrasive wear.

Installation

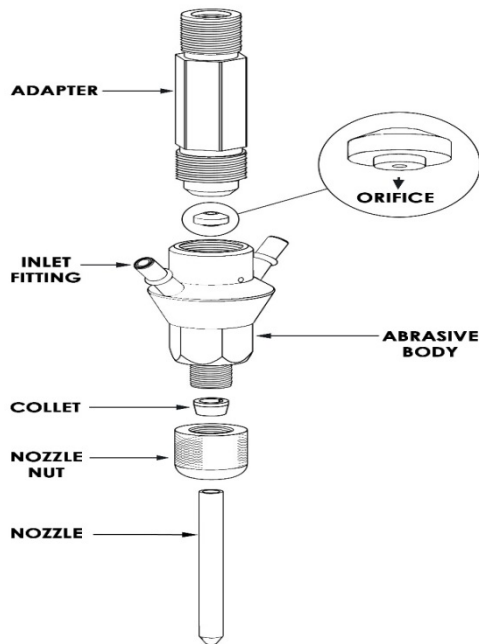

1. Make sure that the top of the cutting head and the bottom of the adapter are clean, wash out if necessary.
2. Apply a light coat of HP lubricant such as AccuGoop to the bottom face and threads of the adapter.
3. Install the orifice retainer with the stepped diameter side down (cone side up) into the cutting head body.
4. Thread the A2 head onto the bottom of the adapter and torque to seal.
5. Use a 1/4" ID hose for feeding abrasive into the head. Push the hose onto one of the abrasive body *inlet fittings* until it is secured past the *ridge*. The other fitting must have a plastic cap installed.
6. Loosen the nozzle nut, slide the nozzle up until it bottoms out in the abrasive body, and tighten the nozzle nut.

Replaceable parts

Nozzle

The nozzle inner diameter wears from the top down. Nozzle life is a function of the orifice size used, quantity and type of abrasive used, and operating pressure. In the A2 head, it is recommended to rotate the nozzle 120 degrees each 8 hours of operation to even the wear on the inside of the nozzle.

Orifice

The most commonly used orifices are, made from either clear or red *sapphire* (ruby). Ruby orifices are economical and can be used for a reasonable period providing the water quality is good. When a sapphire or ruby orifice shows a bad stream it is usually caused by small microscopic chips at the hole and it should be discarded and replaced. Using blown orifices may wear out the area of the abrasive body where the abrasive mixes with the water stream. *Diamond* orifices are also available if longer life is necessary. When diamond orifices give a bad stream they can often be fixed by cleaning them in an ultrasonic cleaner.

Handling

The diamond orifice assembly is held in a precision pilot cavity. Sometimes the diamond orifice may stick inside the abrasive head. Stuck orifices can be removed from the head by blowing shop air in the side abrasive inlet port.

Filtration

The 12533 Thimble Filter inline filter, (optional) is strongly recommended to protect the orifice from larger particulates in the water. The assembly threads into the valve body just above the head and helps to protect the orifice from any damage. If inline filters are not used it is imperative that the high-pressure lines be purged after any work on the pump or HP plumbing.

Adapter (nozzle tube)

After repeated use, the bottom surface of the adapter where it seals against the orifice retainer may become damaged. Applying AccuGoop to the top of the retainer will reduce or eliminate this problem.

Exterior abrasion

Repeated piercing can damage parts exposed to the bounce-back of the jet. A rubber shield that can slide onto the nozzle can be used for protection. These rubber shields can be purchased from Accustream or they can be cut out with the waterjet. There are two optional wear shields available. Part number 11361 is a rubber only guard and 11362 has a carbide faceplate applied to the rubber shield for extreme wear situations.

Optimal cutting parameters

Orifice size

The most commonly used *orifice* sizes for water only are .005" and .006". The most common orifice sizes for abrasive are .010 and .014. As a rule, the starting nozzle to orifice ratio should be 3 to 1. *Example:* A .010" orifice should have a .030" ID nozzle. The following table gives the most commonly used nozzle combinations with their abrasive usage.

Nozzle and orifice combinations

Orifice	Nozzle	Abrasive (pounds/min)	Abrasive mesh
.007	.020	.25	120 – 220
.009	.030	.4 – .6	80 – 120
.010	.030	.5 – .75	80 – 120
.013	.040	1.0 – 1.25	60 – 80
.014	.040	1.1 – 1.35	60 – 80
.015	.040	1.25 – 1.5	60 – 80

Typical combinations by pump size

Horsepower	Qty heads	Orifice/nozzle
30	1	.010/.030
30	2	.006 water
50	1	.014/.040
50	2	.010/.030
75	2	.013/.040
75	3	.010/.030
100	2	.014/.040
100	4	.010/.030
150	3	.014/.040
150	6	.010/.030

Troubleshooting

Clearing plugged nozzles

Plugged nozzles can be cleared by turning the nozzle upside down and carefully loading it up into the head and turning the jet on and off.

Waterjet/abrasivejet stream

The appearance of the waterjet stream will help show the condition of the nozzle and orifice. This will have an effect on the quality of the cuts. A good **water only** stream looks like a “stretched fishing line” along the first inch of its length.



Good abrasivejet stream



Good waterjet stream

Cutting head

Problem	Solution
Orifices do not last at least 20 hours	Not flushing thoroughly when changing orifice
	Poor water quality
	Blown inline filter upstream
Nozzle Life too short or not wearing round	In the A2 head rotate nozzle 120° every shift or 8 hours
	Using too much abrasive
	Running with worn orifice
Abrasive not drawing into head properly	Vacuum leak, check inlet tube connection
	Smaller combinations such as .007/.020 may need to have the nozzle lowered about 1/4” to induce more vacuum
Can't unplug nozzle	Put nozzle upside down in head and cycle jet on/off

Leak points (causes and solutions)

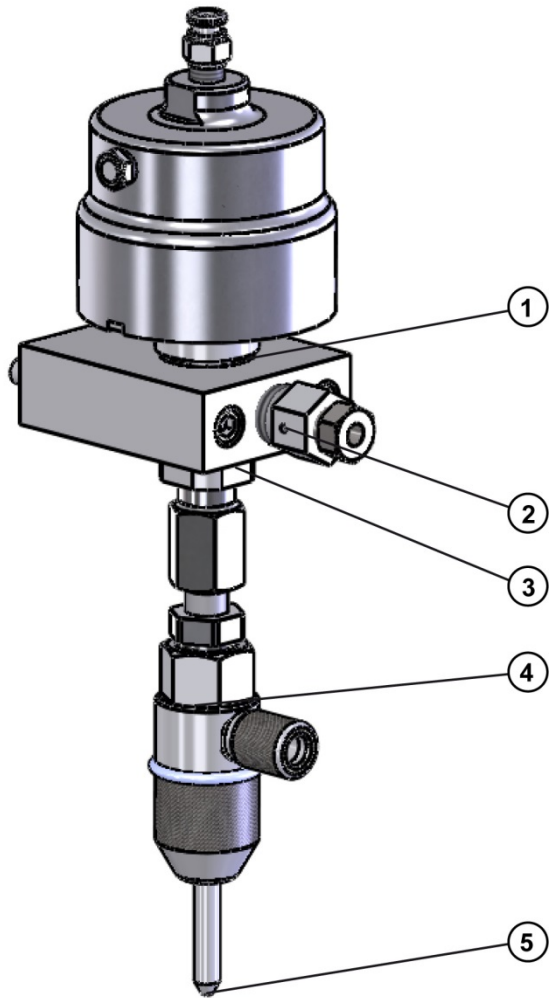

Item	Problem	Solution
1	Seal weep hole	Replace valve seal kit
2	Inlet weep hole	Tighten inlet fitting
3	Leakage at bottom of valve body	Tighten adapter to valve body or tighten inlet fitting in collar
4	Head weep hole	Tighten head to adapter
5	Dripping nozzle when valve closes	Needle and seat are worn and need new valve kit

Drawings and parts lists

Actuator assembly 12828 and 13732

ITEM NO.	DESCRIPTION	TOP INLET	SIDE INLET	DEFAULT/
1	ACTUATOR HOUSING, ACCUVALVE	11212	13729	1
2	ACTUATOR PISTON, ACCUVALVE	11213	11213	1
3	ACCUVALVE SHAFT	11029	11029	1
4	ACTUATOR CAP, ACCUVALVE	11214	11214	1
5	BEARING CAP, ACCUVALVE	11034	11034	1
6	RETAINER CAP, ACCUVALVE	11211	11211	1
7	BEARING, ACTUATOR	12241	12241	1
8	O-RING, 70 DURO, -230	11679-230	11679-230	1
9	O-RING, 70 DURO, -010	11679-010	11679-010	1
10	O-RING, 70 DURO, -011	11679-011	11679-011	1
11	O-RING, 70 DURO, -016	11679-016	11679-016	1
12	SNAP RING	91590A128_grv	12689	1
13	SNAP RING	91590A265_grv	12690	1
14	SPRING, ACCUVALVE	12691	12691	6
15	SOCKET BUTTON HEAD CAP SCREW, #6-32UNC X .25 LG	SBHCSCREW 0.138-32x0.25-HK-N	12734	4
16	MUFFLER, EXHAUST 1/8"	12735	12735	1
17	FITTING, 1/8" NPT X 1/4" TUBE	12736	-----	1
18	125-02.500-SQB POLY SEAL	12737	12737	1
19	1/8" NPT SST PLUG	-----	12817	1
20	FITING, 1/4" TUBE TO 1/8" NPT SWIVEL	-----	13246	1

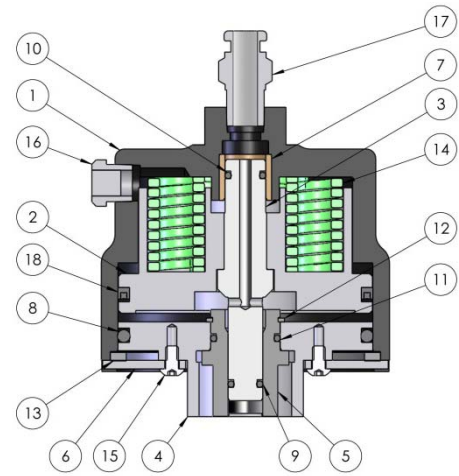

Accuvalve Actuator
Rebuild Kit 12686



SNAP RING	12689
SNAP RING	12690
125-02.500-SQB POLY	12737
O-RING, 70 DURO, -230	11679-230
O-RING, 70 DURO, -016	11679-016
O-RING, 70 DURO, -011	11679-011
O-RING, 70 DURO, -010	11679-010
MUFFLER, EXHAUST 1/8"	12735
FITTING, 1/8" NPT X 1/4"	12736
SPRING, ACCUVALVE	12691

Complete cutting head parts list

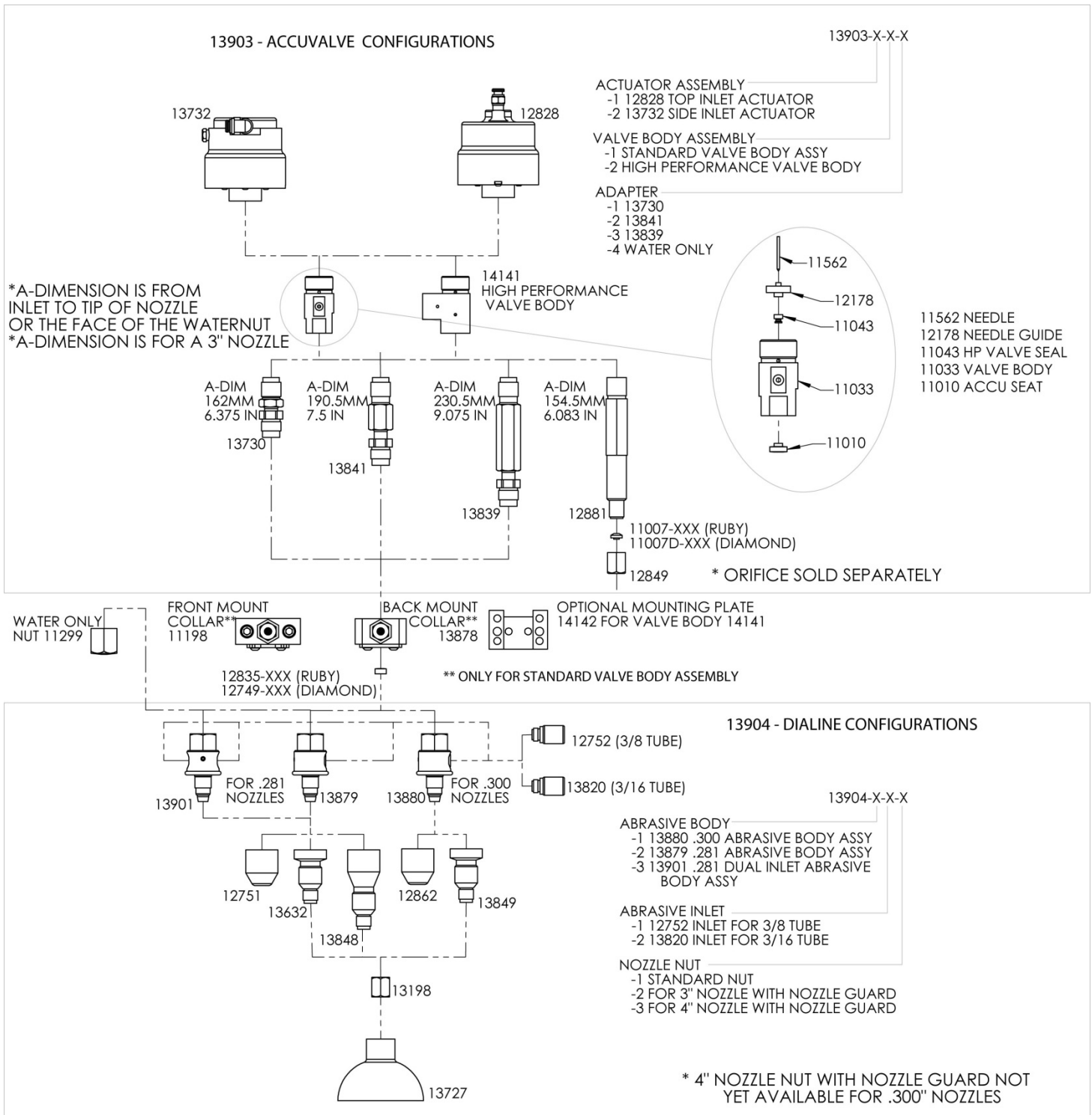



How to Repair an AccuStream AS- or Matrix Series HP Seal Using Kit #11451

Written By: Adam Dumas

TOOLS:

- [Locator Tool #11558](#) (1)
- [Sleeve #11811](#) (1)
- [Push Tool #11812](#) (1)
- [Seal Installation Spacer Tool #12932](#) (1)
- [Rubber Mallet](#) (1)

PARTS:

- [HP Seal Kit #11451](#) (1)
- [Hoop #11018 \(included in kit\)](#) (1)
- [HP Seal with O-ring #11024 \(included in kit\)](#) (1)
- [High Vacuum Grease #11447 \(included in kit\)](#) (1)
- [AS LP Poppet #11526](#) (1)
- [LP Poppet Basket #11520](#) (1)
- [Spacer Tube #11521](#) (1)
- [AS HP Cylinder #11522](#) (1)
- [Blue Goop #11111](#) (1)
- [Isopropyl Alcohol](#) (1)

Step 1 — How to Repair an AccuStream AS- or Matrix Series HP Seal Using Kit #11451



- Loosen [Check Valve](#) by tapping with rubber mallet while rolling cylinder
- Remove check valve from [HP Cylinder](#)
- Remove [LP Poppet](#) from HP cylinder

Step 2

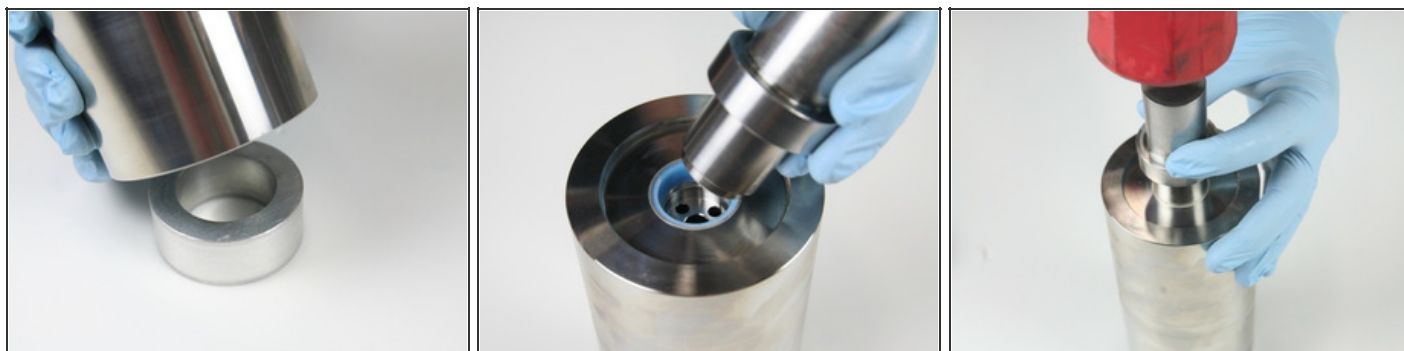

- Place HP cylinder onto locator tool
- Insert stepped end of Push Tool into top of HP cylinder
- Hit push tool with rubber mallet to push out [HP Seal](#) and [Hoop](#)

Step 3

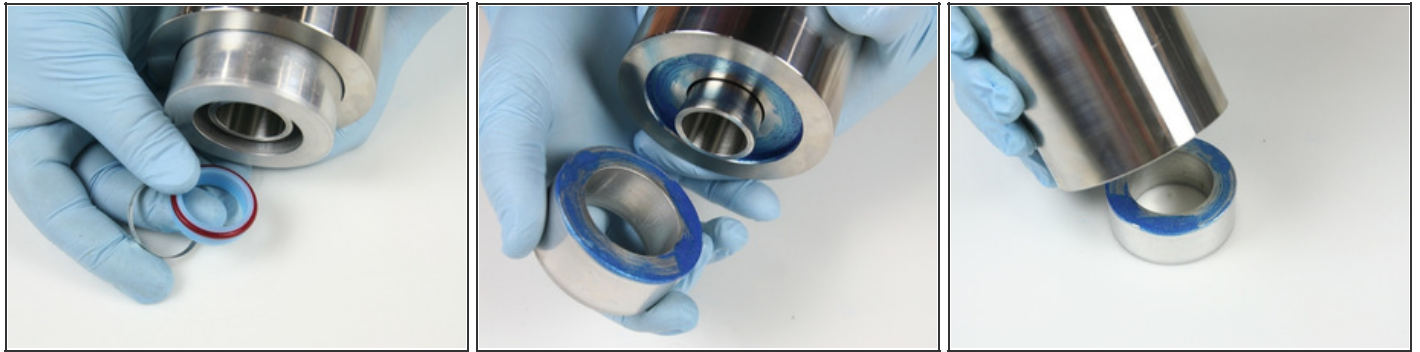

- Remove hoop and HP seal assembly from end of HP cylinder
- Remove locator tool from HP cylinder
- Flip HP cylinder and place onto locator tool

Step 4

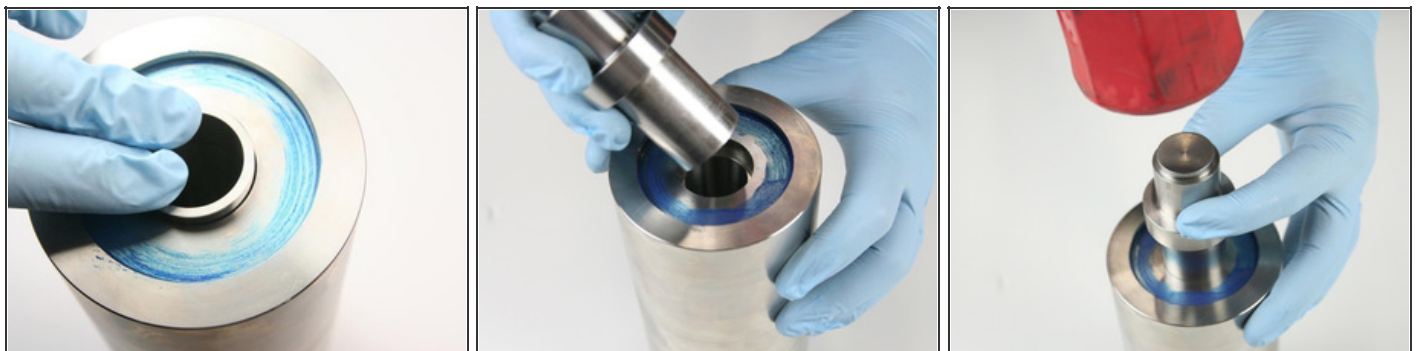

- Push [Spacer Tube](#) down until it bottoms out
- Insert non-stepped end of push tool into HP cylinder
- Hit push tool with rubber mallet to push second hoop and HP seal assembly out of HP cylinder

Step 5

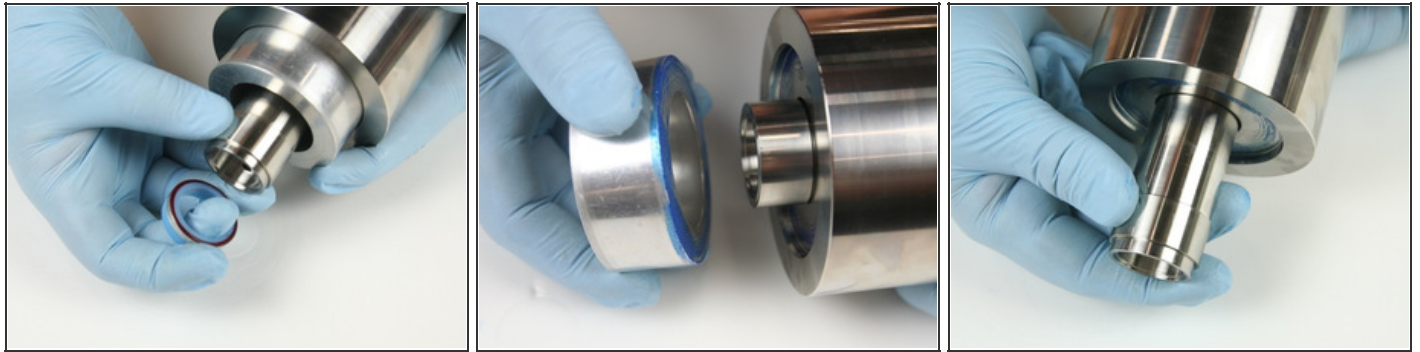

- Remove hoop and HP seal assembly from HP cylinder
- Remove locator tool from HP cylinder
- Remove spacer tube and [LP Poppet Basket](#) from HP cylinder

Step 6



- Clean HP cylinder of all [Blue Goop](#) with isopropyl alcohol or similar
- Clean removal/installation tools
- Clean spacer tube, check valve , LP poppet, and LP poppet basket

Step 7



- Roll Scotch Brite in both ends of bore of HP cylinder to remove any blemishes
- Clean HP cylinder once more to remove all excess material
- Place HP cylinder onto Seal Installation Spacer Tool

Step 8



- Apply a light coat of [High Vacuum Grease](#) to both ends of spacer tube
- Place LP poppet into LP poppet basket with stem of poppet facing basket
- Make sure that LP poppet moves freely in LP poppet basket

Step 9



- Place LP poppet and basket into spacer tube
- Insert spacer tube with poppet and basket up into HP cylinder
- Place locator tool onto HP cylinder

Step 10



- Place sleeve into locator tool with tapered end up
- Apply high vacuum grease to red o-rings
- Place o-rings onto HP seals

Step 11



- Insert HP seal into sleeve with o-ring down
- Insert non-stepped end of push tool into sleeve and press HP seal into HP cylinder until it bottoms out
 - Hold sleeve down against cylinder with one hand to be sure it doesn't raise up while installing seal
- Insert hoop into sleeve with tapered end down towards HP seal



Step 12



- Insert non-stepped end of push tool into sleeve and be sure that tool is level with sleeve
- Use rubber mallet to seat hoop into HP cylinder (until push tool bottoms out)
 - Hold sleeve down against cylinder with one hand to be sure it doesn't raise up while installing hoop
- Remove installation tools from top of HP cylinder



Step 13



- Place check valve on HP cylinder
- Use rubber mallet to tap check valve into HP cylinder
- Flip HP cylinder over so cylinder is resting on check valve

Step 14

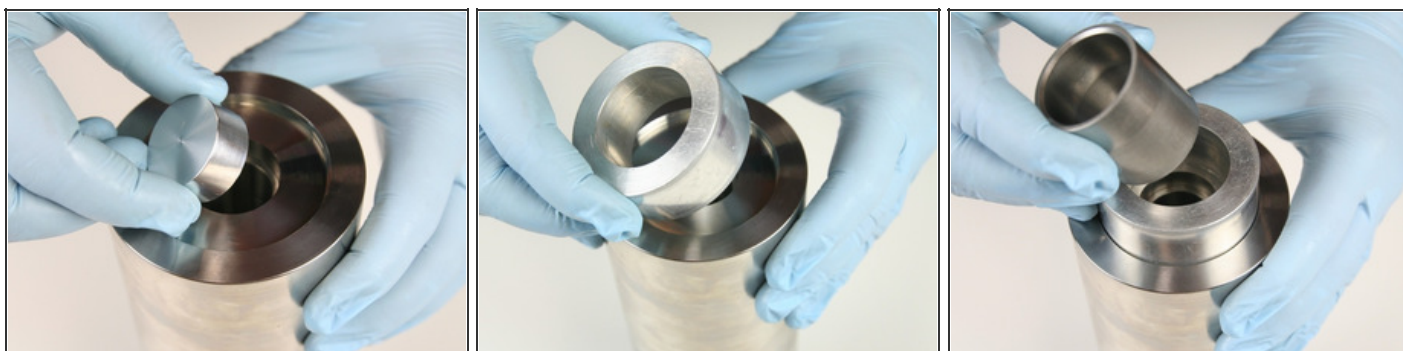

- Remove seal installation spacer tool from end of HP cylinder
- Place locator tool on HP cylinder
- Insert sleeve into locator tool with tapered end up

Step 15



- Insert HP seal into sleeve with o-ring down
- Insert non-stepped end of push tool into sleeve and press HP seal into HP cylinder until it bottoms out
 - Hold sleeve down against cylinder with one hand to be sure it doesn't raise up while installing seal
- Insert hoop into sleeve with tapered end down towards HP seal



Step 16



- Insert non-stepped end of push tool into sleeve and be sure that tool is level with sleeve
- Use rubber mallet to seat hoop into HP cylinder (until push tool bottoms out)
 - Hold sleeve down against cylinder with one hand to be sure it doesn't raise up while installing hoop
- Remove installation tools from top of HP cylinder



Step 17

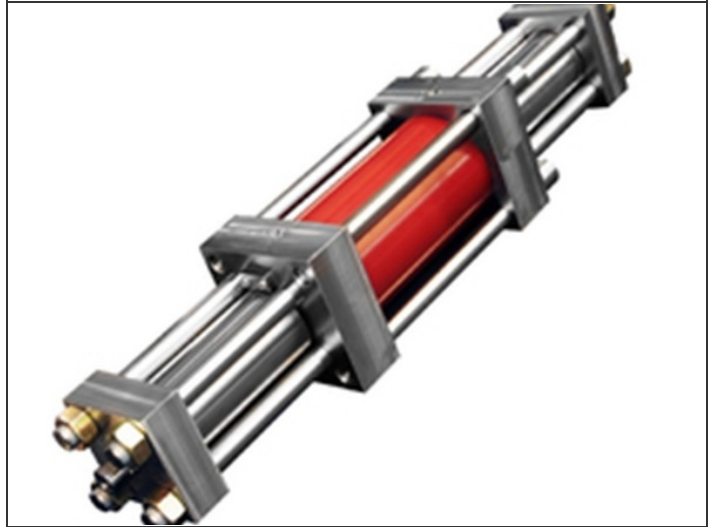
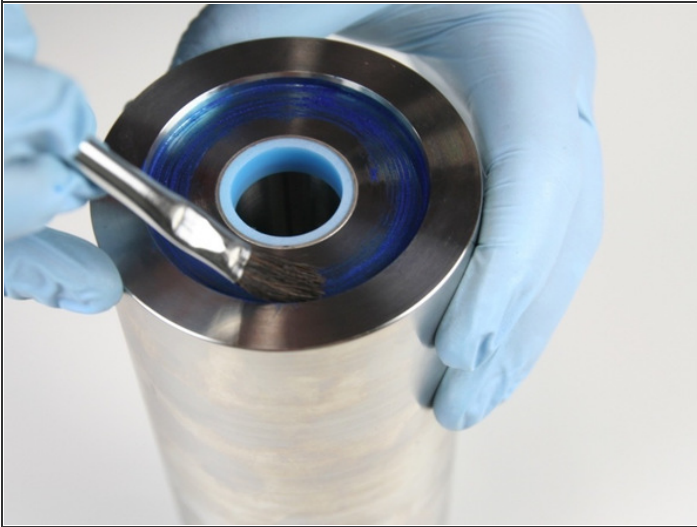

- Apply blue goop to outer edge of HP cylinder inset
- Continue with installation with HP cylinder onto intensifier

This document was last generated on 2013-09-05 08:09:08 AM.



How to Repair an AccuStream On/Off Valve Using Kit #11328

Written By: Adam Dumas

TOOLS:

- [13/16" Wrench](#) (1)
- [7/8" Wrench](#) (1)
- [1" Wrench](#) (1)

PARTS:

- [Repair Kit # 11328](#) (1)
- [Needle #11562 \(Included in Kit\)](#) (1)
- [Needle Bearing #12178 \(Included in Kit\)](#) (1)
- [HP Valve Seal #11043 \(Included in Kit\)](#) (1)
- [Seat #11010 \(Included in Kit\)](#) (1)
- [Actuator #12828](#) (1)
- [Adapter #13841](#) (1)
- [Valve Body #11033](#) (1)
- [Blue Goop #11111](#) (1)
- [Isopropyl Alcohol](#) (1)

Step 1 — How to Repair an AccuStream On/Off Valve Using Kit #11328



- Always make sure all high-pressure water has been removed from valve by following machine manufacturers' safety instructions. Failure to do so can cause severe injury or death.



- Turn OFF all water pressure to on/off valve
- Turn on/off valve ON to raise [Needle](#) from [Seat](#)

Step 2

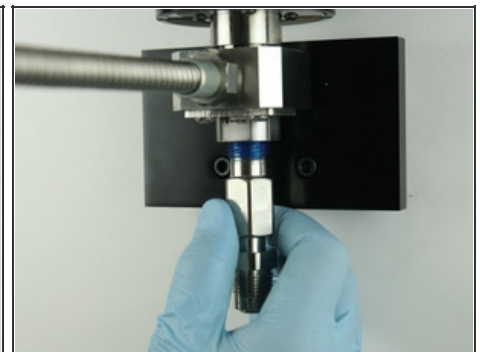
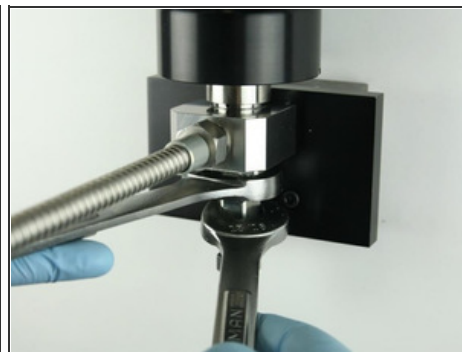
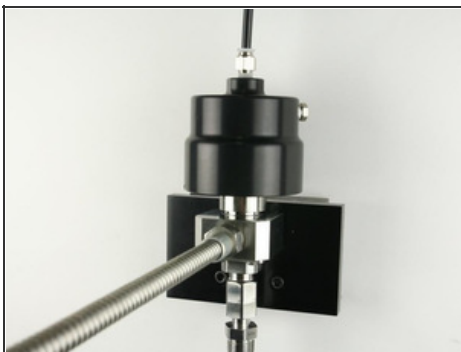

- Components can be replaced with [Valve Body](#) in mounting collar
- Loosen [Adapter](#) from valve body using a 1" and 13/16" wrench
- Unthread adapter from valve body

Step 3

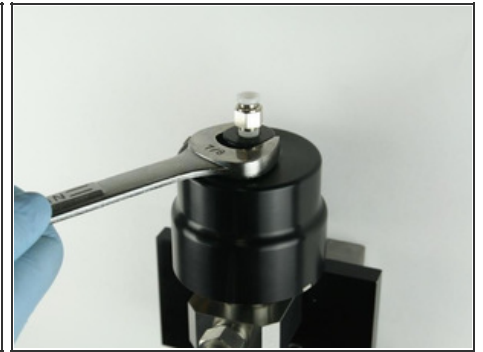
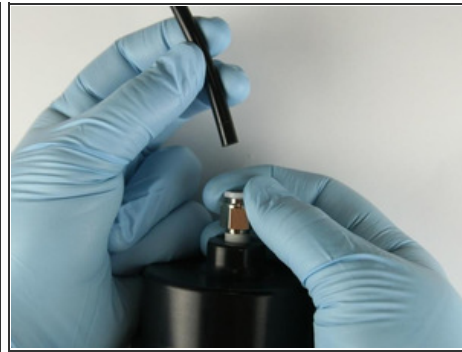

- Turn air to actuator OFF
- Disconnect air line from [Actuator](#)
- Loosen actuator from valve body using a 7/8" wrench

Step 4

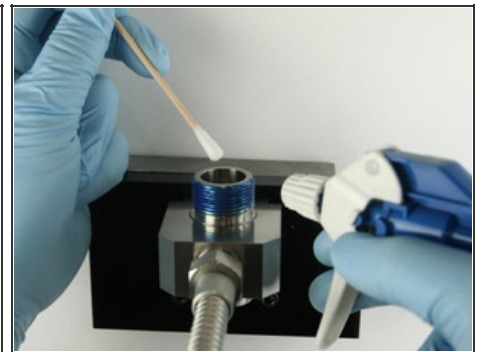
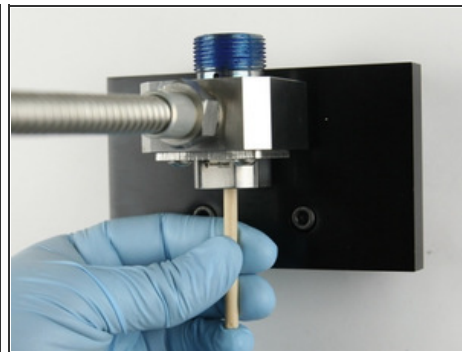
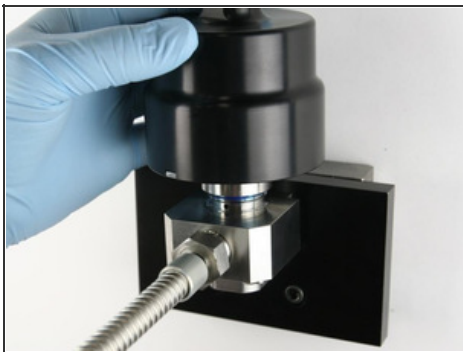

- Unthread actuator from valve body
- Remove all valve components using included dowel
- Thoroughly clean interior/exterior of valve body before replacing components

Step 5

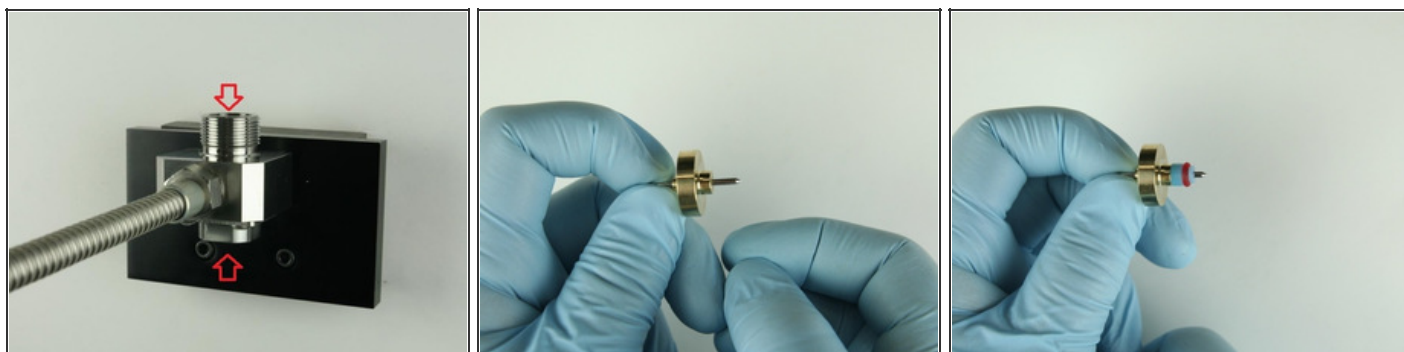

- Check top and bottom of bore for cracks/blemishes. If excessive wear or cracks are visible, replace [Valve Body](#)
- Slide [Needle Bearing](#) onto needle point with smaller steppe away from needle point
- Slide [HP Valve Seal](#) onto needle point with red o-ring away from needle bearing

Step 6

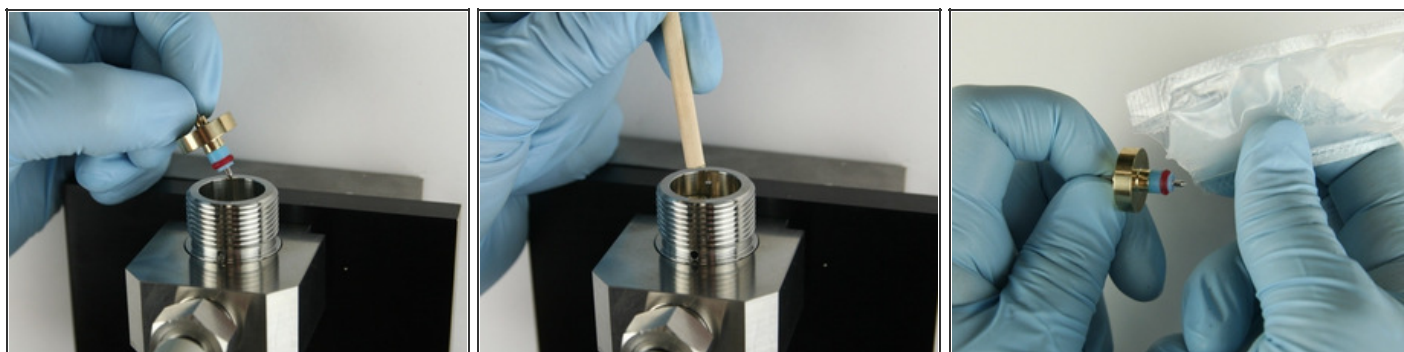

- Apply a HP lubricant to outside diameter of HP valve seal
- Insert needle point at top of valve body
- Use dowel to push needle in valve body until needle bearing bottoms out

Step 7

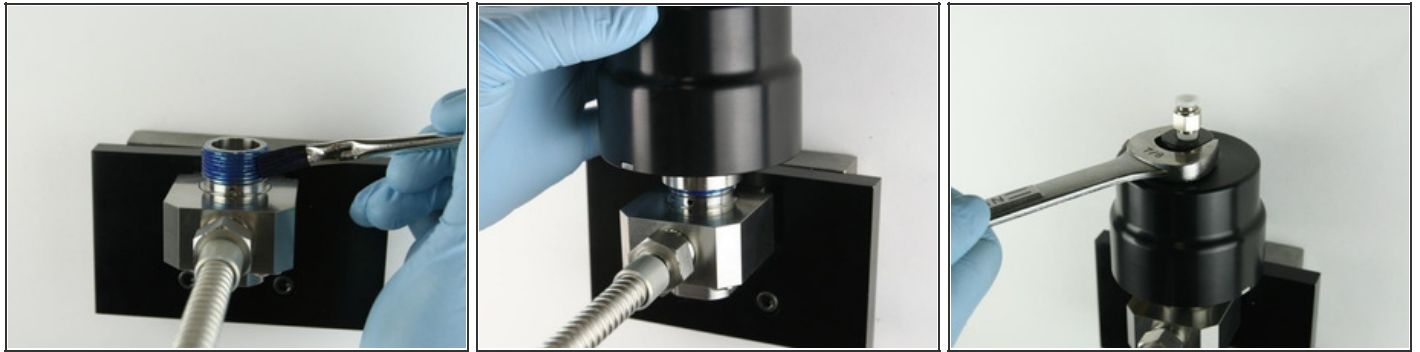

- Apply [Blue Goop](#) to top threads of valve body
- Thread actuator onto valve body
- Tighten actuator to valve body using a 7/8" wrench

Step 8



- Reconnect air line to top of actuator
- Clean adapter of all blue goop with isopropyl alcohol or similar cleaning agent
- Reapply blue goop to top threads and top of adapter

Step 9

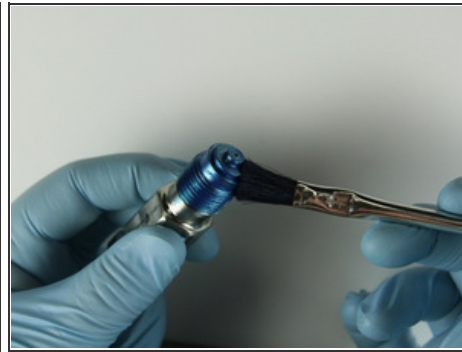

- Place seat at top of adapter with flat side towards adapter
- Apply blue goop to top of seat
- Turn air to actuator ON

Step 10

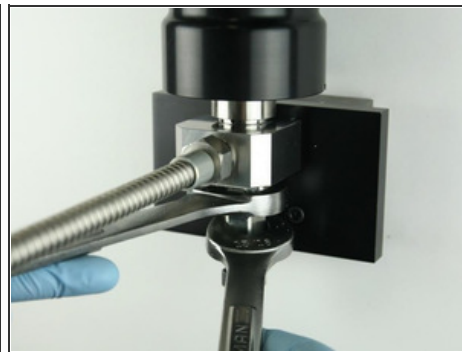
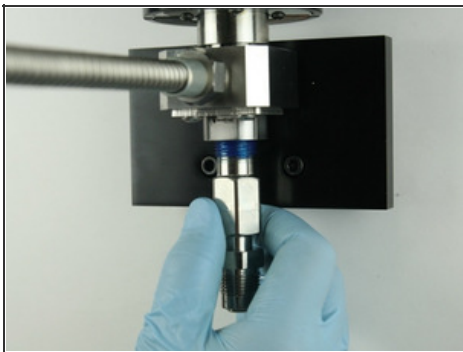

- Thread adapter into valve body
- Tighten adapter into valve body using a 1" and 13/16" wrench
- Turn air to actuator OFF

Step 11



- Apply water pressure to the valve assembly to verify there are no leaks
- Quickly cycle the valve on and off a few times to purge the system of all contaminants before installing cutting head
- Reinstall cutting head and continue cutting process

This document was last generated on 2013-08-25 11:48:44 PM.



How to Repair a Bleed Down Valve Assembly II #12981

Written By: Adam Dumas

TOOLS:

- [1-1/4" Wrench](#) (1)
- [1-1/16" Wrench](#) (1)
- [1" Wrench](#) (1)
- [7/8" Wrench](#) (1)
- [13/16" Wrench](#) (1)
- [5/8" Wrench](#) (1)
- [5/16" Socket Wrench](#) (1)

PARTS:

- [BDV II Body #12943](#) (1)
- [BDV II Needle #12942](#) (1)
- [BDV HP Seal #11321](#) (1)
- [BDV Seal Hoop #11323](#) (1)
- [BDV Stem Bushing #11324](#) (1)
- [Poppet Seat #11141](#) (1)
- [Seal Backup Screw #12945](#) (1)
- [Outlet Adapter #12944](#) (1)
- [Flow Reducer #11743](#) (1)
- [BDV Housing Body #11779](#) (1)
- [BDV Hydraulic Piston #11778](#) (1)
- [Backup O-Ring #11680-114](#) (1)
- [Male to Female Hydraulic Adapter #11796](#) (1)
- [O-ring SAE #12880-912](#) (1)
- [O-ring Lube #13969](#) (1)
- [High Vacuum Grease #11447](#) (1)
- [Blue Goop #11111](#) (1)
- [Isopropyl Alcohol](#) (1)

Step 1 — How to Repair a Bleed Down Valve Assembly II #12981

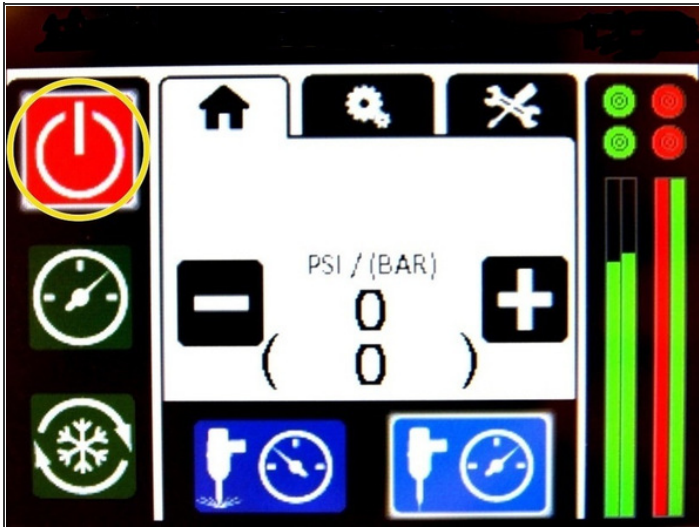

- Always make sure all high-pressure water has been removed from valve by following machine manufacturers' safety instructions. Failure to do so can cause severe injury or death.



- Turn OFF all hydraulic and water pressure to bleed-down valve
- Loosen hydraulic hose from hydraulic fitting using 7/8" and 3/4" wrench

Step 2

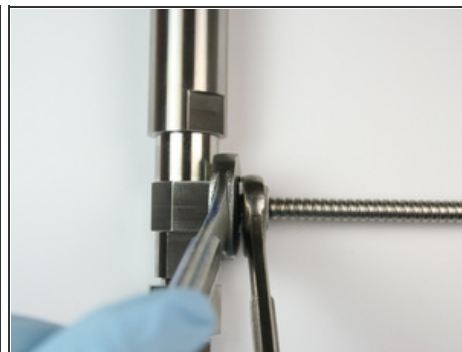

- Unthread hose from hydraulic fitting
- Loosen 1/4" gland nut from side inlet of valve body
- Unthread 1/4" gland nut from side inlet of valve body

Step 3

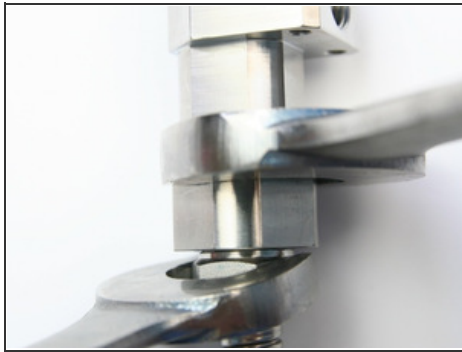
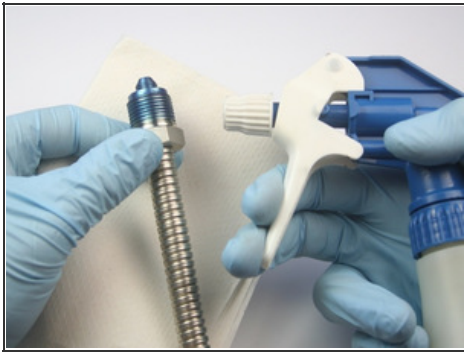

- Clean 3/8" gland nut of all blue goop with isopropyl alcohol
- Loosen 3/8" HP gland from outlet adapter using 13/16" and 1" wrench
- Unthread 3/8" HP gland from outlet adapter

Step 4



- Clean 3/8" gland nut of all blue goop with isopropyl alcohol
- Loosen hydraulic fitting from adapter fitting using 1-1/4" and 7/8" wrench
- Unthread hydraulic fitting from adapter fitting

Step 5

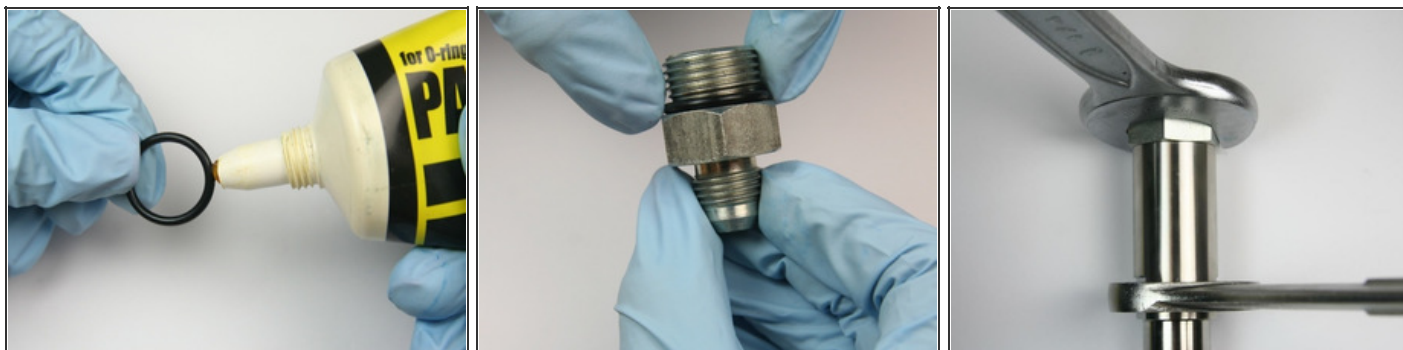

- Apply o-ring lubricant to o-ring from kit for hydraulic fitting
- Replace o-ring on hydraulic fitting with o-ring in kit (smallest o-ring in kit)
- Loosen adapter fitting from Actuator Housing using 1-1/4" and 1-1/16" wrench

Step 6



- Unthread adapter fitting from actuator housing
- Apply o-ring lubricant to largest o-ring in kit
- Replace o-ring on adapter fitting with largest o-ring in kit

Step 7

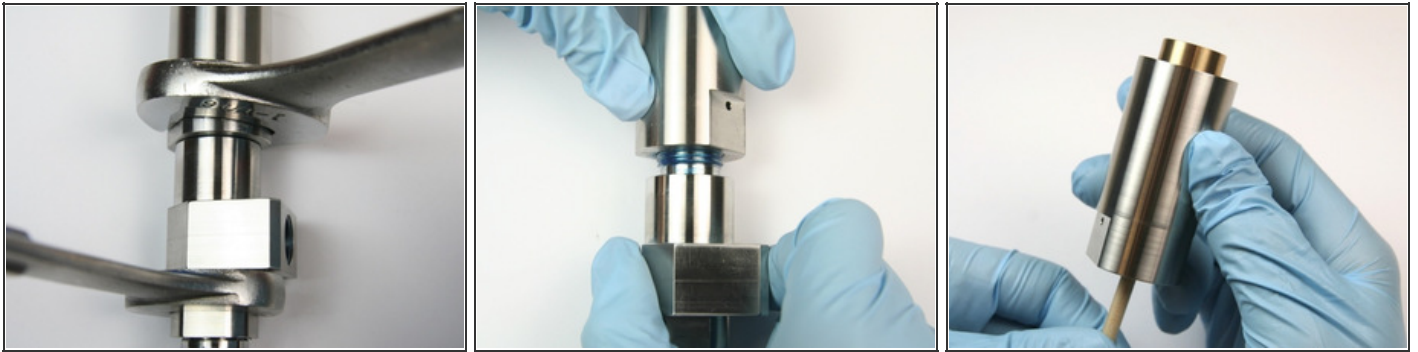

- Loosen actuator housing from Valve Body using 1-1/16" and 7/8" wrench
- Unthread actuator housing from valve body
- Push Piston out of actuator housing through oil port using included dowel

Step 8

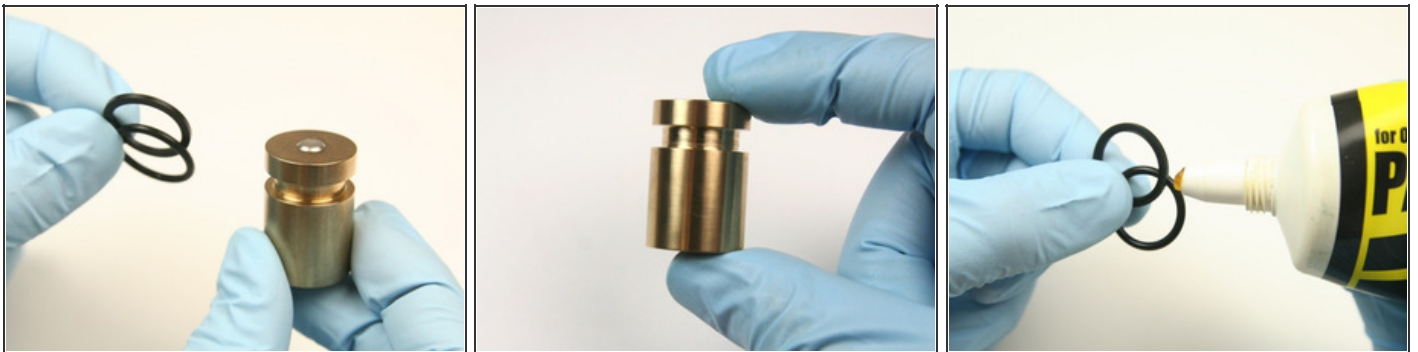

- Discard o-ring and back-up ring from piston
- Inspect piston, if damage is visible, replace
- Apply o-ring lubricant to o-ring and back-up ring

Step 9



- Slide new back-up ring (flat) into groove of piston.
 - Make sure concave of back-up ring side is towards o-ring
- Slide new o-ring (rounded) into groove of piston
- Insert piston assembly into actuator housing and push with included dowel



Step 10

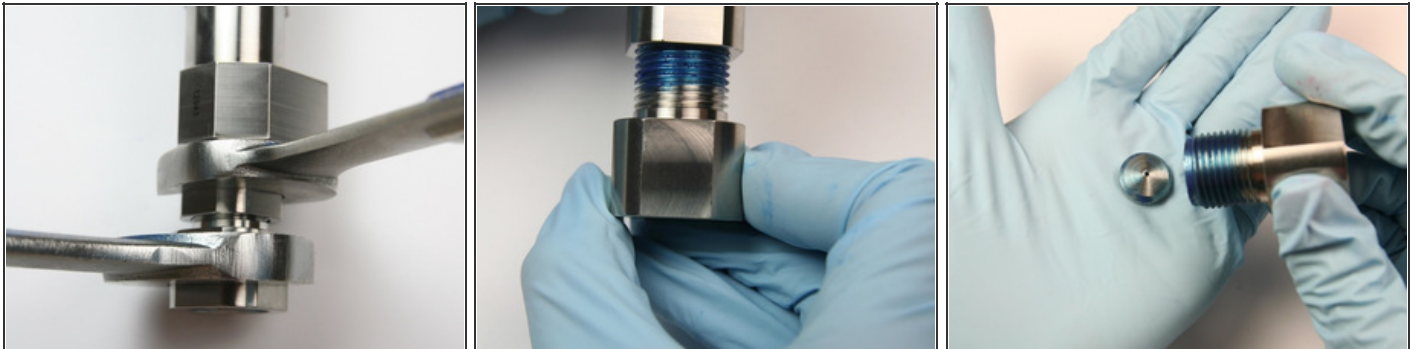

- Loosen outlet fitting from bleed down valve body using 7/8" and 13/16" wrench
- Unthread outlet fitting from bleed down valve body
- Remove HP Seat from bleed down valve body and discard

Step 11



- Remove [Flow Reducer](#) from outlet adapter
- Clean outlet adapter and flow reducer of all blue goop with isopropyl alcohol
- Loosen back-up screw from top of bleed down valve body using 5/16" socket wrench

Step 12

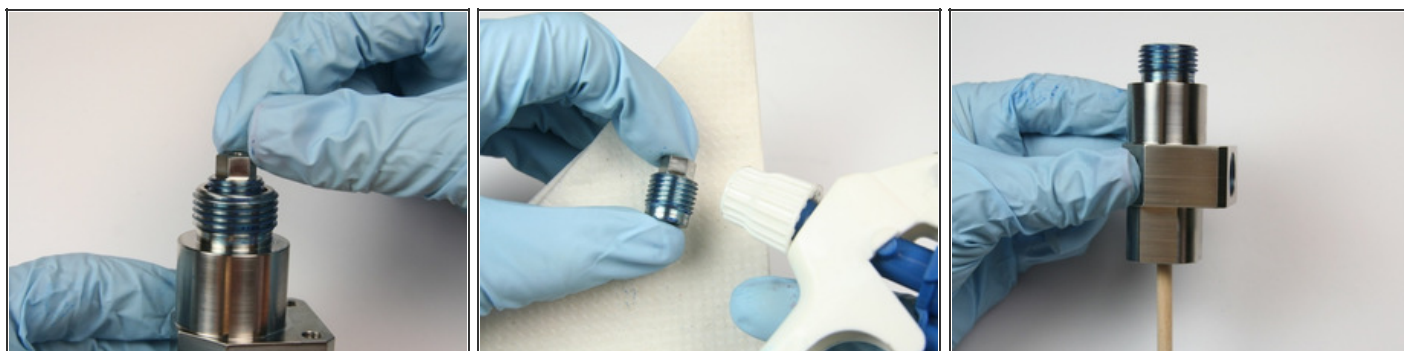

- Unthread [Seal Back-up Screw](#) from top of bleed down valve body
- Clean seal back-up screw with isopropyl alcohol
- Push components through bleed down valve body with included dowel

Step 13

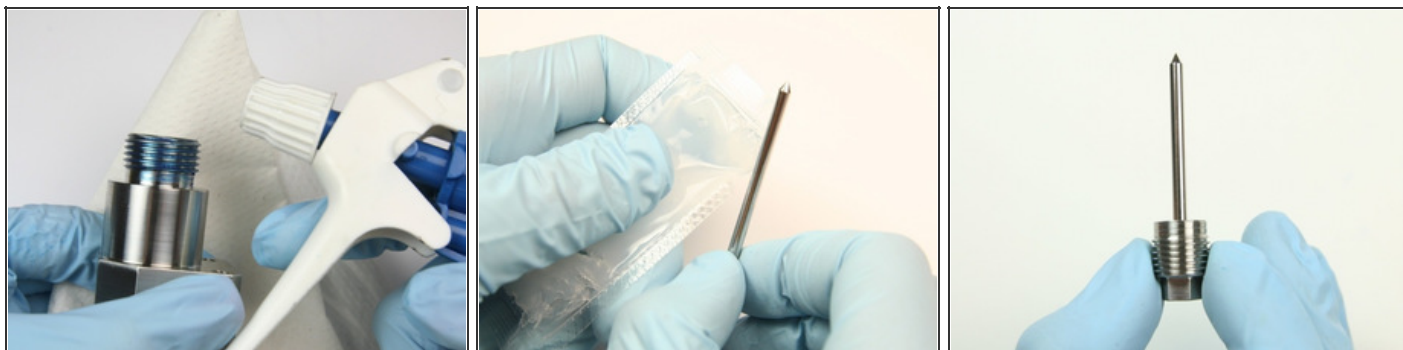

- Clean bleed down valve body with isopropyl alcohol or similar
- Apply [High Vacuum Grease](#) to Needle
- Slide back-up screw on to needle so flat end of needle is flush with non threaded part of back-up screw

Step 14

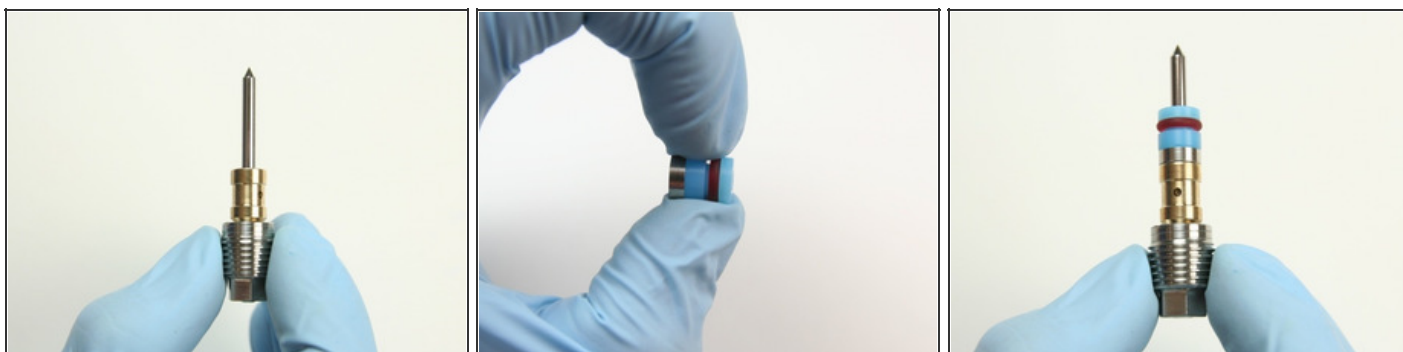

- Slide bushing onto point of needle with chamfered end towards back-up screw
- Place hoop onto HP Seal with tapered end towards seal and opposite from o-ring
- Place HP seal assembly onto point of needle with hoop first

Step 15



- Apply high vacuum grease to exterior of HP seal, hoop, and bushing
- Apply high vacuum grease to internal threads of bleed down valve body
- Insert high pressure needle assembly into top of bleed down valve body with point first

Step 16



- Push seal back-up screw inside of valve body until it bottoms out
- Take seal back-up screw out of body and apply a layer of blue goop to threads
- Thread in back-up screw into top of bleed down valve body

Step 17



- Tighten back-up screw to top of bleed down valve body using a 5/16" socket wrench
- Place flow reducer into hole beneath seat cavity in outlet adapter
- Apply a layer of blue goop to external threads and seat cavity of outlet adapter

Step 18

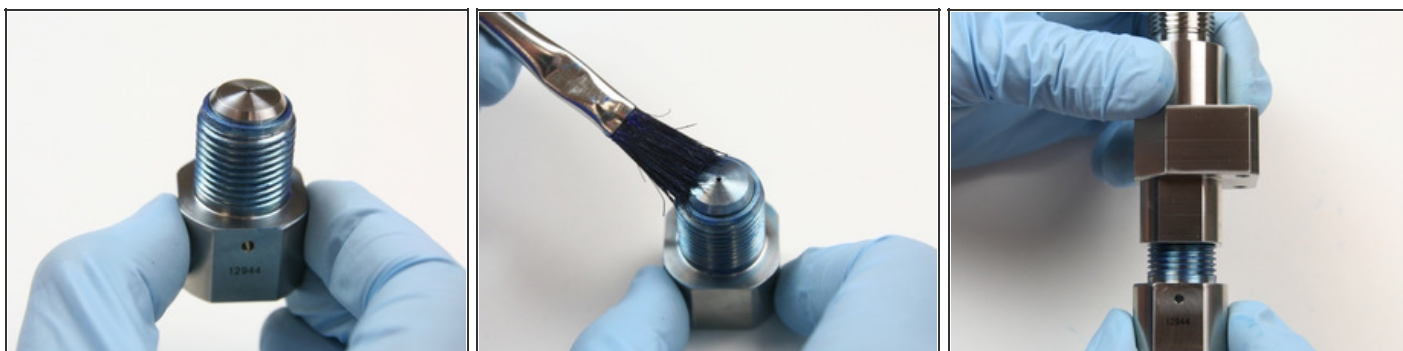

- Place poppet seat into seat cavity of outlet adapter
- Apply a layer of blue goop to top of poppet seat sitting in outlet adapter
- Thread outlet adapter into valve body

Step 19

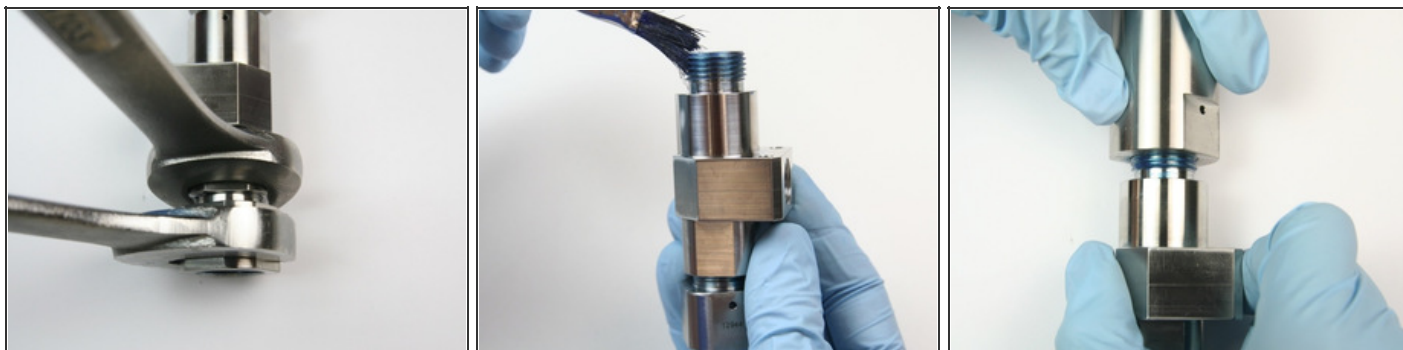

- Using a 1" wrench on outlet adapter and a 7/8" wrench on the valve body, tighten securely
- Apply a layer of blue goop to external threads of valve body
- Thread actuator housing onto valve body

Step 20



- Tighten using a 1-1/16" wrench on actuator housing and a 7/8" wrench on valve body
- Apply blue goop to 3/8" gland nut threads
- Thread 3/8" gland nut with HP tubing into bleed down valve adapter

Step 21



- Tighten gland nut into bleed down valve adapter using 13/16" and 5/8" wrench
- Apply blue goop to 1/4" gland nut threads
- Thread 1/4" gland nut into side of bleed down valve body

Step 22



- Tighten gland nut to side of bleed down valve body with using 3/4" and 5/8" wrench
- Thread adapter fitting into actuator housing
- Tighten adapter fitting into actuator housing using 1-1/4" and 1-1/16" wrench

Step 23



- Thread hydraulic fitting into hydraulic adapter
- Tighten hydraulic fitting into hydraulic adapter
- Thread hydraulic hose onto hydraulic fitting

Step 24



- Tighten hydraulic hose to hydraulic fitting using 7/8" and 3/4" wrench
- Turn pump ON and continue cutting process

This document was last generated on 2013-09-05 12:58:05 PM.